

TABLE OF CONTENTS

1	Before driving	Adjusting and operating features such as door locks, mirrors, and steering column
2	When driving	Driving, stopping and safe-driving information
3	Interior features	Air conditioning and audio systems, as well as other interior features for a comfortable driving experience
4	Maintenance and care	Cleaning and protecting your vehicle, performing do-it-yourself maintenance, and maintenance information
5	When trouble arises	What to do if the vehicle needs to be towed, gets a flat tire, or is involved in an accident
6	Vehicle specifications	Detailed vehicle information
7	For owners	Reporting safety defects for U.S. owners, and seat belt and SRS airbag instructions for Canadian owners
	Index	Alphabetical listing of information contained in this manual

For vehicles with an Entune Premium Audio with Navigation or Entune Audio Plus, refer to the “NAVIGATION AND MULTIMEDIA SYSTEM OWNER’S MANUAL” for information regarding the equipment listed below.

- Navigation system

- Audio system

1	Before driving	
1-1.	Key information	
	Keys	28
1-2.	Opening, closing and locking the doors	
	Smart key system.....	30
	Wireless remote control	45
	Side doors	50
	Back door	56
1-3.	Adjustable components (seats, mirrors, steering wheel)	
	Front seats	67
	Rear seats.....	70
	Driving position memory.....	73
	Head restraints.....	78
	Seat belts	81
	Steering wheel	88
	Inside rear view mirror.....	89
	Outside rear view mirrors	92

1-4.	Opening and closing the windows and moon roof	
	Power windows.....	96
	Moon roof	100
	Sunshade	104
1-5.	Refueling	
	Opening the fuel tank cap.....	105
1-6.	Theft deterrent system	
	Engine immobilizer system	109
	Alarm	112
	Theft prevention labels (U.S.A.).....	116
1-7.	Safety information	
	Correct driving posture	117
	SRS airbags	119
	Front passenger occupant classification system.....	134
	Child restraint systems	140
	Installing child restraints	146

2 When driving

2-1. Driving procedures

Driving the vehicle..... 162
 Engine (ignition) switch
 (vehicles with smart
 key system)..... 173
 Engine (ignition) switch
 (vehicles without smart
 key system)..... 177
 Automatic transmission..... 180
 Turn signal lever 185
 Parking brake..... 186
 Horn 187

2-2. Instrument cluster

Gauges and meters 188
 Indicators and warning
 lights 191
 Multi-information display
 (TFT type) 194
 Multi-information display
 (LCD type) 206
 Fuel consumption
 information 210

2-3. Operating the lights and wipers

Headlight switch 212
 Automatic High Beam..... 216
 Fog light switch..... 223
 Windshield wipers
 and washer..... 225
 Rear window wiper
 and washer..... 229

2-4. Using other driving systems

Cruise control 231
 Intuitive parking assist..... 235
 Rear view monitor
 system..... 243
 Driving assist systems..... 256
 Hill-start assist control 262

2-5. Driving information

Utility vehicle
 precautions..... 264
 Cargo and luggage..... 269
 Vehicle load limits..... 274
 Winter driving tips..... 276
 Trailer towing..... 281
 Dinghy towing..... 302

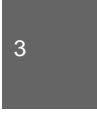

3 Interior features

3-1. Using the air conditioning system and defogger

Automatic air conditioning system..... 306
 Rear window defogger 316

3-2. Using the audio system (Entune Audio)

Audio system types 318
 Audio system..... 320
 Steering wheel audio switches 323
 USB Port/AUX Port 325
 Basic Audio Operations..... 326
 Setup menu 329
 General settings 330
 Audio settings..... 332
 Display settings 333
 Voice settings..... 335
 Selecting the audio source 336
 List screen operation..... 337
 Optimal use of the audio system..... 339
 Radio operation..... 340
 CD player operation 343
 Listening to an iPod..... 350
 Listening to a USB memory device 356
 Using the AUX port 362
 Preparations to use wireless communication..... 363

Registering a Bluetooth® audio player for the first time..... 366
 Registering a Bluetooth® phone for the first time..... 367
 Registering a Bluetooth® device 368
 Connecting a Bluetooth® device 370
 Displaying a Bluetooth® device details..... 373
 Detailed Bluetooth® system settings..... 375
 Listening to Bluetooth® Audio 377
 Using a Bluetooth® Phone 379
 Making a call..... 382
 Receiving a call 386
 Speaking on the phone..... 387
 Bluetooth® phone message function 391
 Using the steering wheel switches..... 396
 Bluetooth® phone settings 397
 Contact/Call History Settings 399
 What to do if.. (Troubleshooting) 411
 Bluetooth® 419
 Voice command system 426

3-3. Using the interior lights

- Interior lights list 430
- Personal/interior light main switch 431
- Personal/interior lights and luggage compartment light 432

3-4. Using the storage features

- List of storage features 434
- Glove box 435
- Console boxes 436
- Overhead console 438
- Cup holders 439
- Bottle holders 441
- Auxiliary boxes 442

3-5. Other interior features

- Sun visors 445
- Vanity mirror 446
- Power outlets 447
- Seat heaters 449
- Armrest 451
- Assist grips (folding type) 452
- Floor mats 453
- Luggage compartment features 455
- Garage door opener 457
- Compass 464

4 Maintenance and care

4-1. Maintenance and care

- Cleaning and protecting the vehicle exterior 470
- Cleaning and protecting the vehicle interior 473

4-2. Maintenance

- Maintenance requirements 476
- General maintenance 479
- Emission inspection and maintenance (I/M) programs 482

4-3. Do-it-yourself maintenance

- Do-it-yourself service precautions 483
- Hood 487
- Positioning a floor jack 489
- Engine compartment 491
- Tires 506
- Tire inflation pressure 513
- Wheels 517
- Air conditioning filter 520
- Key battery 523
- Checking and replacing fuses 527
- Light bulbs 537

5 When trouble arises

5-1. Essential information

Emergency flashers 554
 If your vehicle needs
 to be towed 555
 If you think something is
 wrong 561
 Fuel pump shut off
 system..... 563

5-2. Steps to take in an emergency

If a warning light turns
 on or a warning buzzer
 sounds... 564
 If a warning message is
 displayed..... 578
 If you have a flat tire 579
 If the engine will not start ... 590
 If the shift lever cannot be
 shifted from “P” 593
 If you lose your keys 594
 If the electronic key does
 not operate properly
 (vehicles with smart key
 system) 595
 If the battery is
 discharged 598
 If your vehicle overheats 603
 If the vehicle becomes
 stuck..... 606
 If your vehicle has to be
 stopped in an
 emergency 608

6 Vehicle specifications

6-1. Specifications

Maintenance data
 (fuel, oil level, etc.) 612
 Fuel information 626
 Tire information..... 630

6-2. Customization

Customizable features 645

6-3. Initialization

Items to initialize 655

7 For owners

Reporting safety defects
 for U.S. owners..... 658
 Seat belt instructions for
 Canadian owners
 (in French) 659
 SRS airbag instructions for
 Canadian owners
 (in French) 661

Index

Abbreviation list..... 674

Alphabetical index 676

What to do if... 685

1

2

3

4

5

6

7

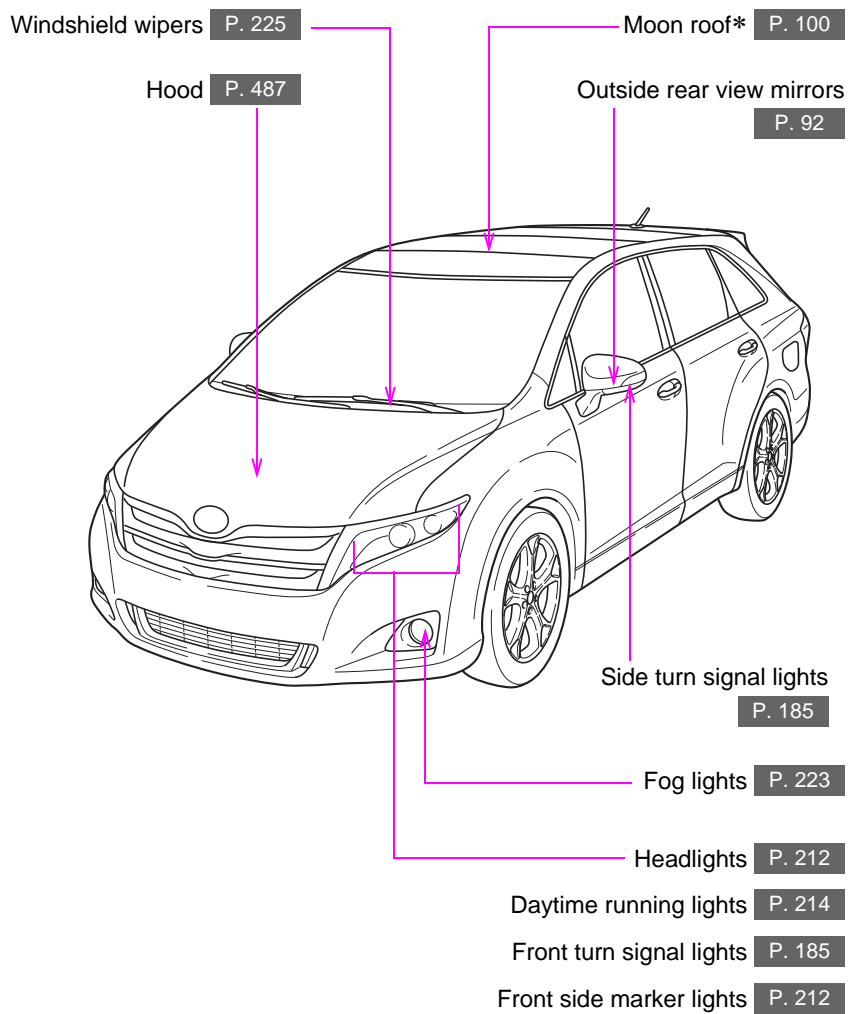

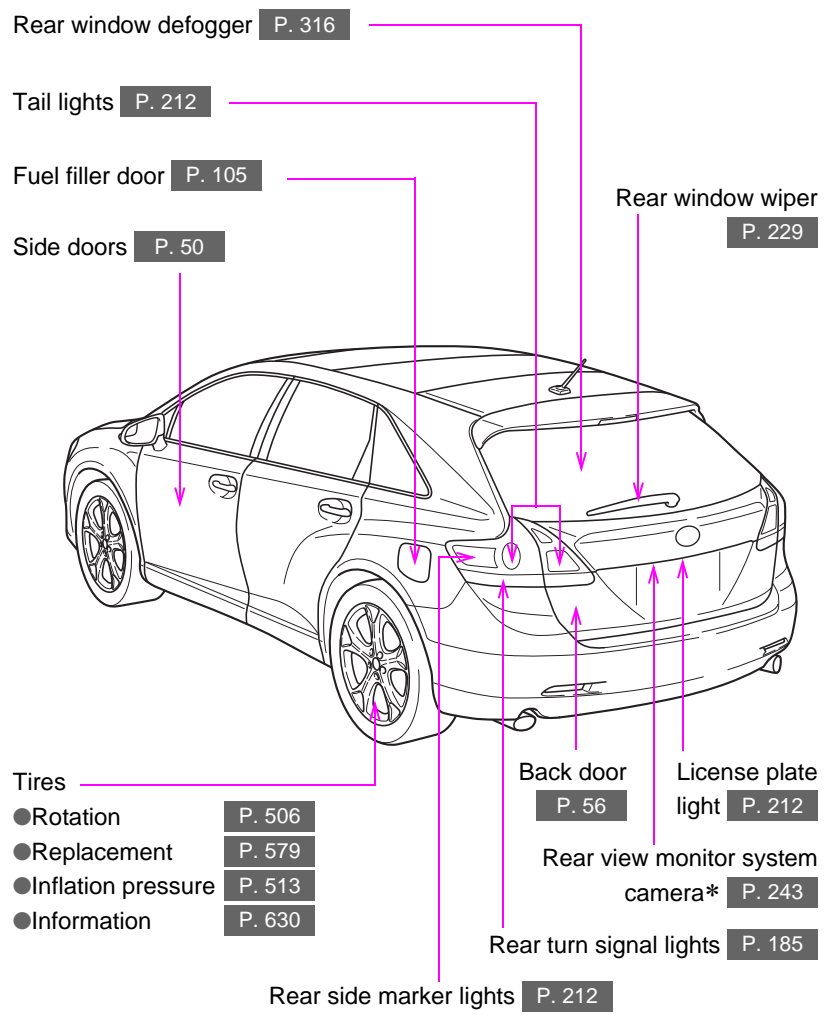

*: If equipped

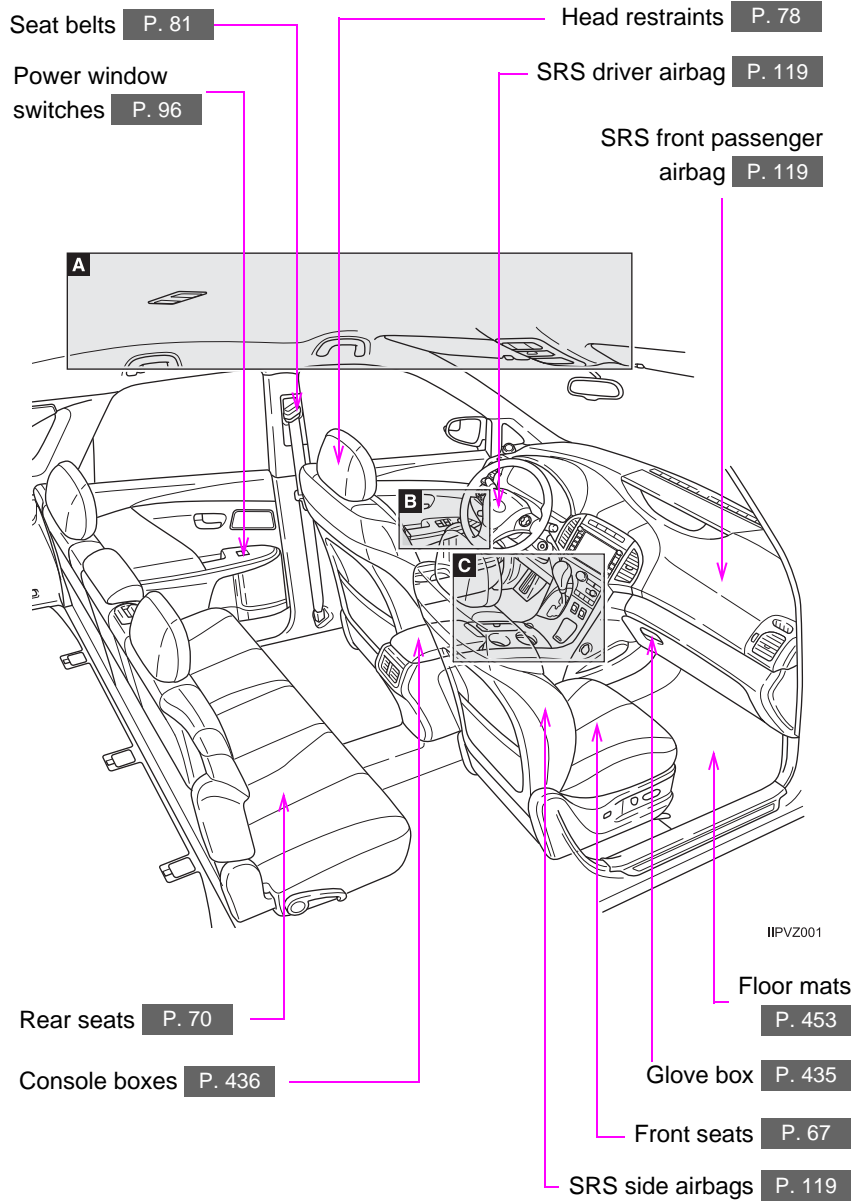

A

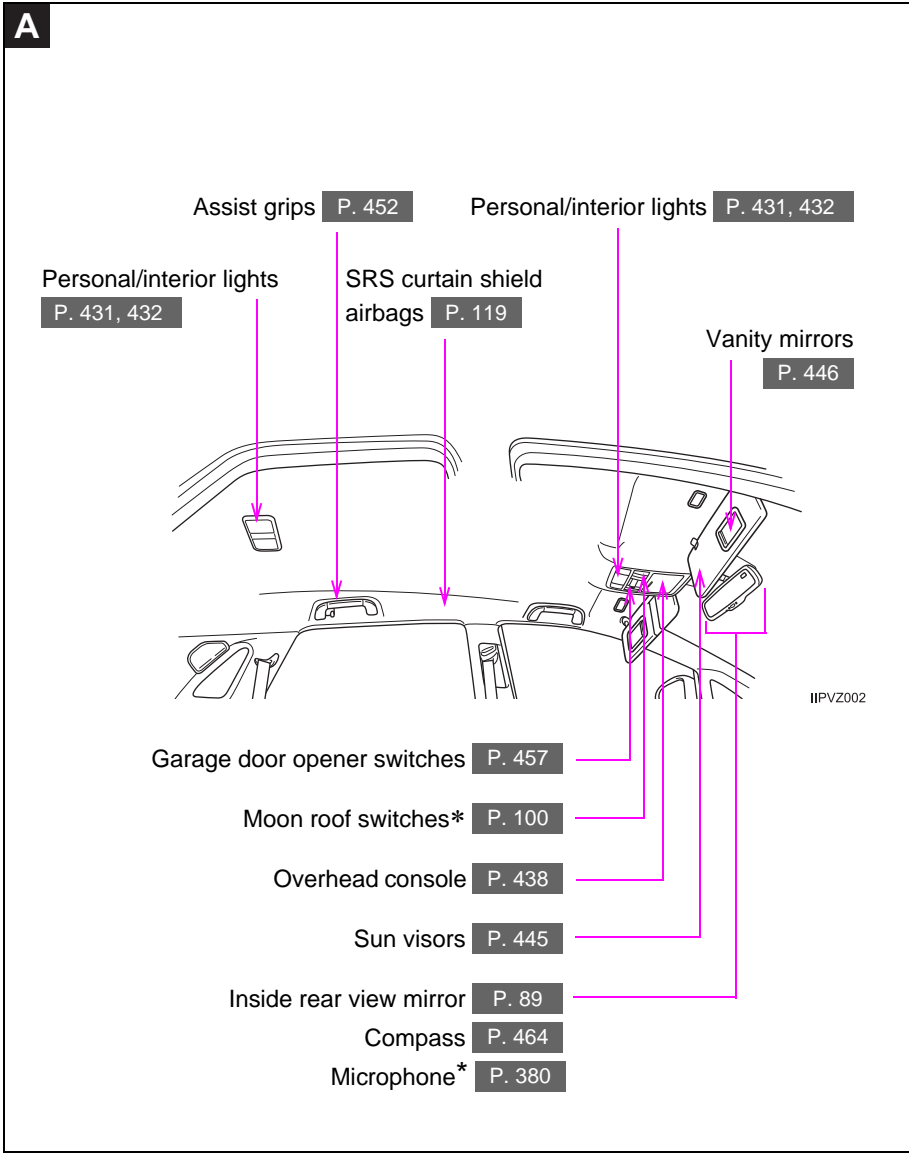

*: If equipped

*: Refer to "NAVIGATION AND MULTIMEDIA SYSTEM OWNER'S MANUAL".

B

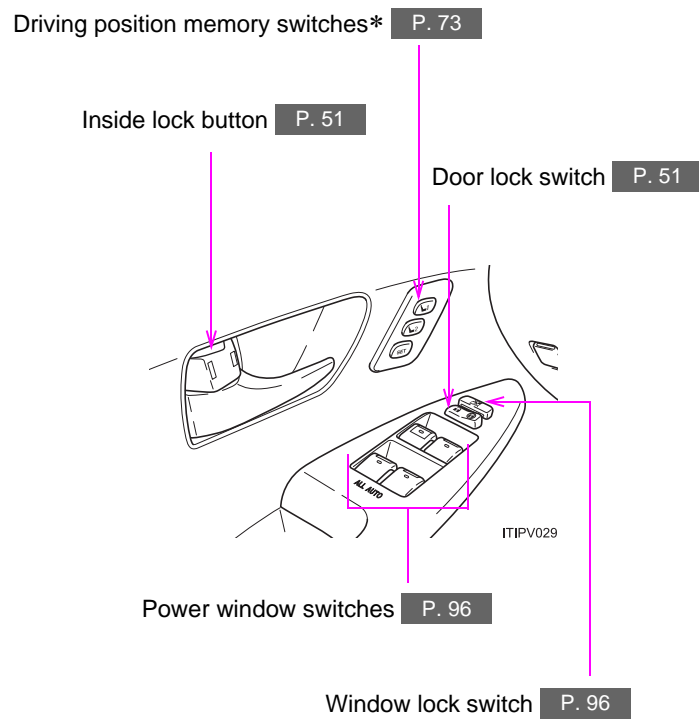

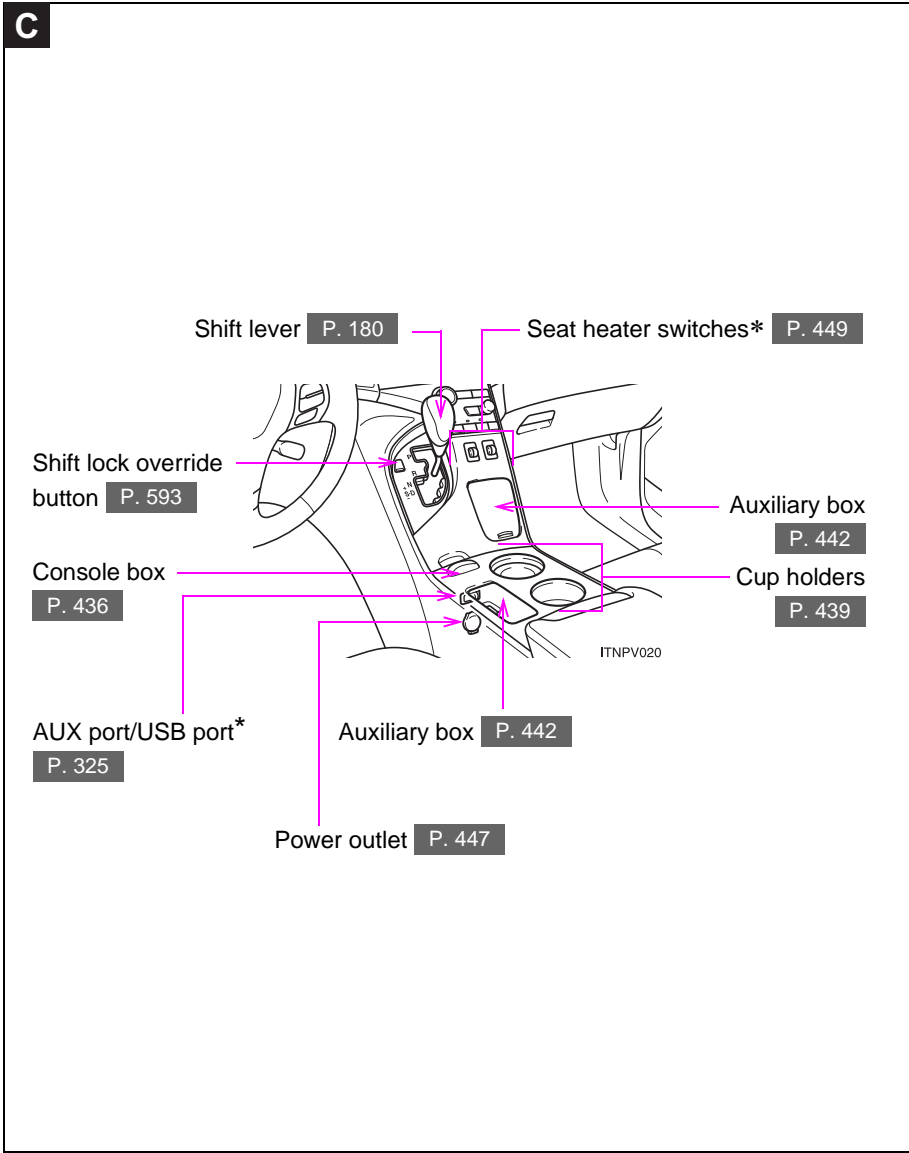

*: If equipped

*: Refer to "NAVIGATION AND MULTIMEDIA SYSTEM OWNER'S MANUAL".

Pictorial index

Instrument panel

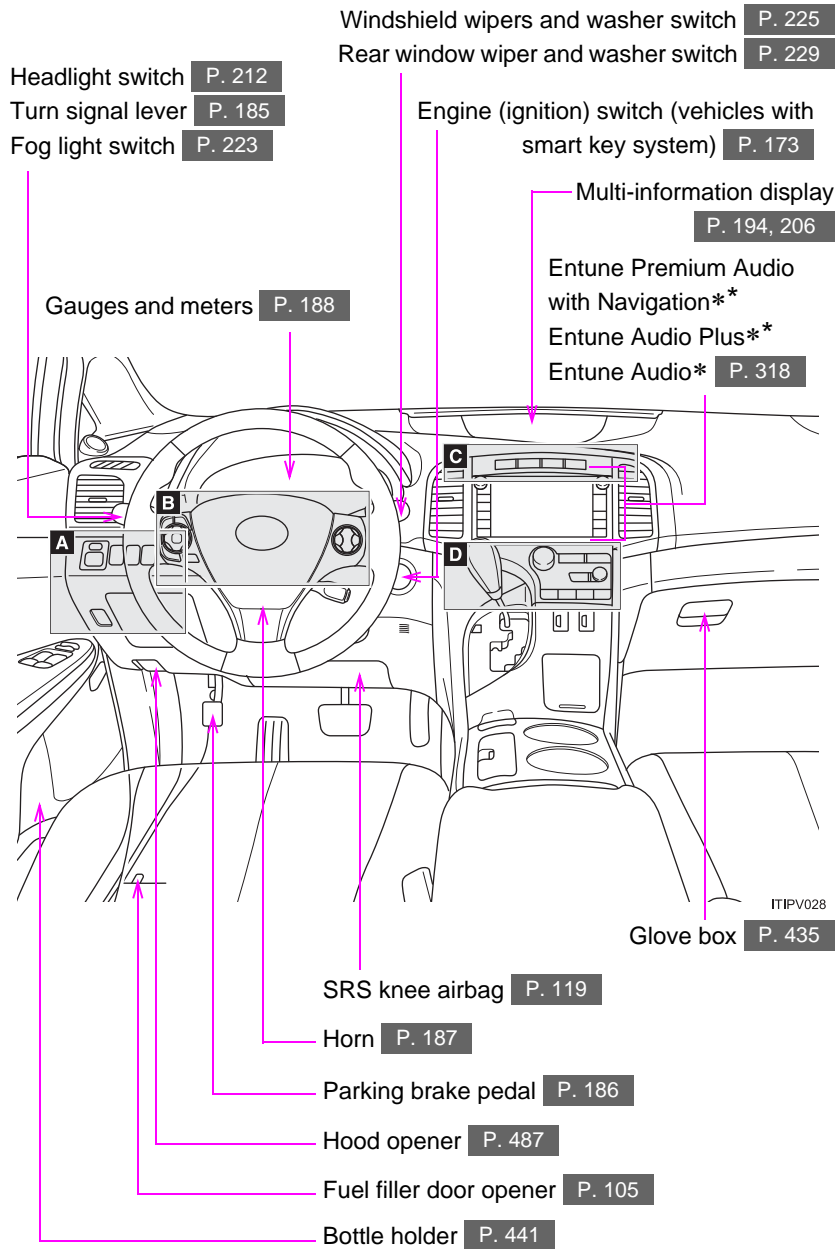

A

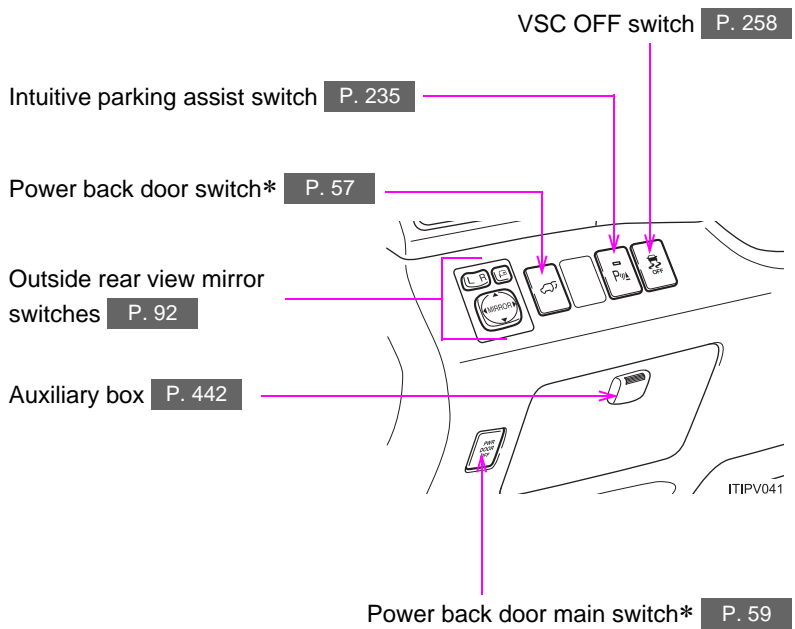

*: If equipped
*: Refer to "NAVIGATION AND MULTIMEDIA SYSTEM OWNER'S MANUAL".

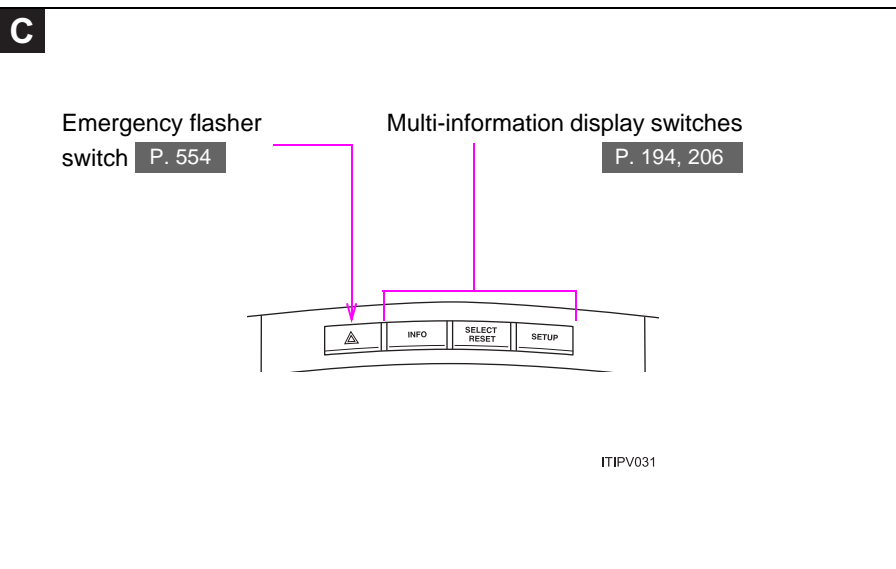
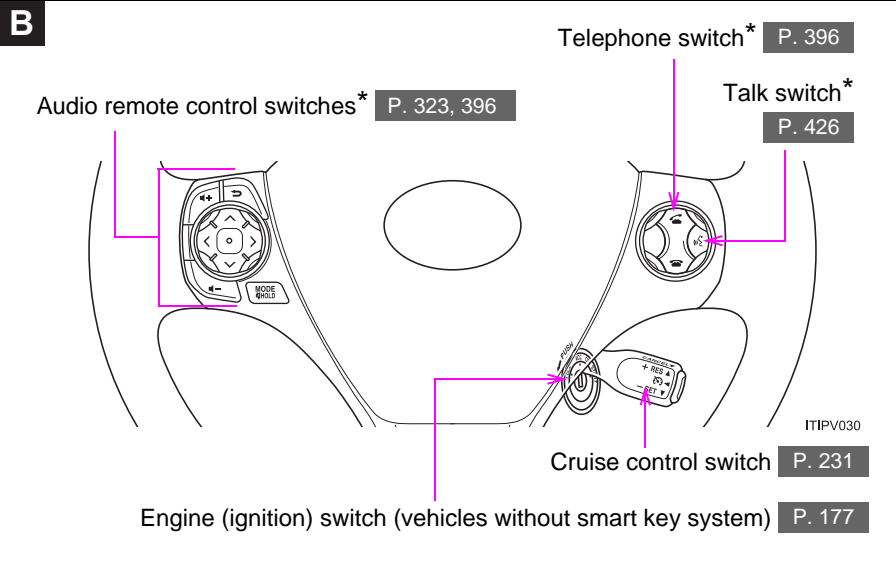

D

Air conditioning system P. 306

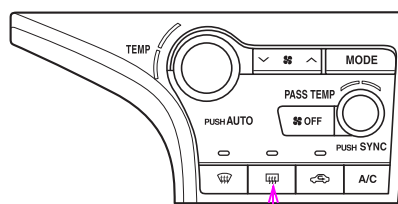

ITNPV012

Rear window defogger switch P. 316

*: Refer to "NAVIGATION AND MULTIMEDIA SYSTEM OWNER'S MANUAL".

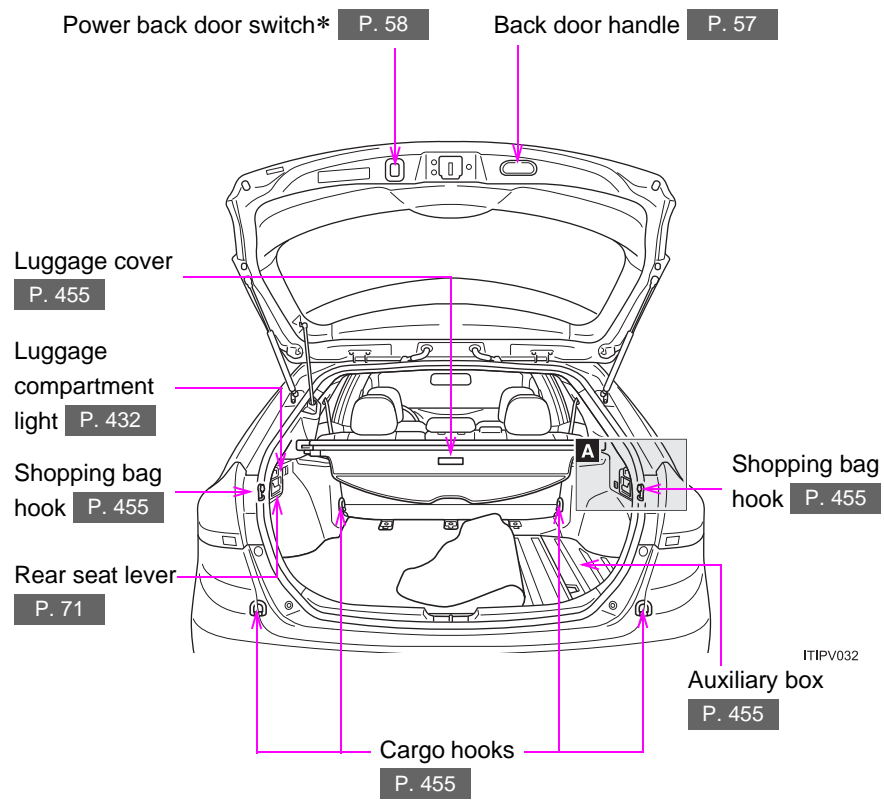

A

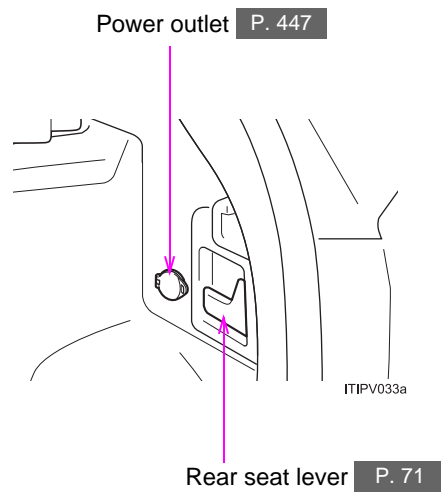

*: If equipped

For your information

Main Owner's Manual

Please note that this manual applies to all models and explains all equipment, including options. Therefore, you may find some explanations for equipment not installed on your vehicle.

All specifications provided in this manual are current at the time of printing. However, because of the Toyota policy of continual product improvement, we reserve the right to make changes at any time without notice.

Depending on specifications, the vehicle shown in the illustration may differ from your vehicle in terms of equipment.

Noise from under vehicle after turning off the engine

Approximately five hours after the engine is turned off, you may hear sound coming from under the vehicle for several minutes. This is the sound of a fuel evaporation leakage check and, it does not indicate a malfunction.

Accessories, spare parts and modification of your Toyota

A wide variety of non-genuine spare parts and accessories for Toyota vehicles are currently available in the market. You should know that Toyota does not warrant these products and is not responsible for their performance, repair, or replacement, or for any damage they may cause to, or adverse effect they may have on, your Toyota vehicle.

This vehicle should not be modified with non-genuine Toyota products. Modification with non-genuine Toyota products could affect its performance, safety or durability, and may even violate governmental regulations. In addition, damage or performance problems resulting from the modification may not be covered under warranty.

Installation of a mobile two-way radio system

The installation of a mobile two-way radio system in your vehicle could affect electronic systems such as:

- Multiport fuel injection system/sequential multiport fuel injection system
- Cruise control system
- Anti-lock brake system
- SRS airbag system
- Seat belt pretensioner system

Be sure to check with your Toyota dealer for precautionary measures or special instructions regarding installation of a mobile two-way radio system.

Vehicle data recordings

Your Toyota is equipped with several sophisticated computers that will record certain data, such as:

- Engine speed
- Accelerator status
- Brake status
- Vehicle speed
- Shift position

The recorded data varies according to the vehicle grade level and options with which it is equipped. Furthermore, these computers do not record conversations, sounds or pictures.

● Data usage

Toyota may use the data recorded in these computers to diagnose malfunctions, conduct research and development, and improve quality.

Toyota will not disclose the recorded data to a third party except:

- With the consent of the vehicle owner or with the consent of the lessee if the vehicle is leased
- In response to an official request by the police, a court of law or a government agency
- For use by Toyota in a lawsuit
- For research purposes where the data is not tied to a specific vehicle or vehicle owner

Event data recorder

This vehicle is equipped with an event data recorder (EDR). The main purpose of an EDR is to record, in certain crash or near crash-like situations, such as an air bag deployment or hitting a road obstacle, data that will assist in understanding how a vehicle's systems performed. The EDR is designed to record data related to vehicle dynamics and safety systems for a short period of time, typically 30 seconds or less.

The EDR in this vehicle is designed to record such data as:

- How various systems in your vehicle were operating;
- Whether or not the driver and passenger safety belts were buckled/fastened;
- How far (if at all) the driver was depressing the accelerator and/or brake pedal; and,
- How fast the vehicle was traveling.

These data can help provide a better understanding of the circumstances in which crashes and injuries occur.

NOTE: EDR data are recorded by your vehicle only if a nontrivial crash situation occurs; no data are recorded by the EDR under normal driving conditions and no personal data (e.g., name, gender, age, and crash location) are recorded. However, other parties, such as law enforcement, could combine the EDR data with the type of personally identifying data routinely acquired during a crash investigation.

To read data recorded by an EDR, special equipment is required, and access to the vehicle or the EDR is needed. In addition to the vehicle manufacturer, other parties, such as law enforcement, that have the special equipment, can read the information if they have access to the vehicle or the EDR.

- Disclosure of the EDR data

Toyota will not disclose the data recorded in an EDR to a third party except when:

- An agreement from the vehicle's owner (or the lessee for a leased vehicle) is obtained
- In response to an official request by the police, a court of law or a government agency
- For use by Toyota in a lawsuit

However, if necessary, Toyota may:

- Use the data for research on vehicle safety performance
- Disclose the data to a third party for research purposes without disclosing information about the specific vehicle or vehicle owner

Scrapping of your Toyota

The SRS airbag and seat belt pretensioner devices in your Toyota contain explosive chemicals. If the vehicle is scrapped with the airbags and seat belt pretensioners left as they are, this may cause an accident such as fire. Be sure to have the systems of the SRS airbag and seat belt pretensioner removed and disposed of by a qualified service shop or by your Toyota dealer before you scrap your vehicle.

Perchlorate Material

Special handling may apply,

See www.dtsc.ca.gov/hazardouswaste/perchlorate.

Your vehicle has components that may contain perchlorate. These components may include airbag, seat belt pretensioners, and wireless remote control batteries.

 CAUTION

■ **General precautions while driving**

Driving under the influence: Never drive your vehicle when under the influence of alcohol or drugs that have impaired your ability to operate your vehicle. Alcohol and certain drugs delay reaction time, impair judgment and reduce coordination, which could lead to an accident that could result in death or serious injury.

Defensive driving: Always drive defensively. Anticipate mistakes that other drivers or pedestrians might make and be ready to avoid accidents.

Driver distraction: Always give your full attention to driving. Anything that distracts the driver, such as adjusting controls, talking on a cellular phone or reading can result in a collision with resulting death or serious injury to you, your occupants or others.

■ **General precaution regarding children's safety**

Never leave children unattended in the vehicle, and never allow children to have or use the key.

Children may be able to start the vehicle or shift the vehicle into neutral. There is also a danger that children may injure themselves by playing with the cigarette lighter, the windows, the moon roof, or other features of the vehicle. In addition, heat build-up or extremely cold temperatures inside the vehicle can be fatal to children.

Symbols used throughout this manual

Cautions & Notices

CAUTION

This is a warning against anything which may cause injury to people if the warning is ignored. You are informed about what you must or must not do in order to reduce the risk of injury to yourself and others.

NOTICE

This is a warning against anything which may cause damage to the vehicle or its equipment if the warning is ignored. You are informed about what you must or must not do in order to avoid or reduce the risk of damage to your Toyota and its equipment.

Symbols used in illustrations



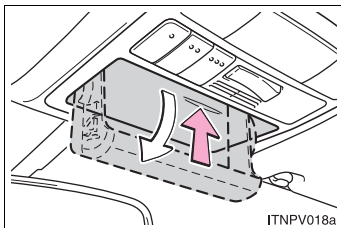

Safety symbol

The symbol of a circle with a slash through it means “Do not”, “Do not do this”, or “Do not let this happen”.



Arrows indicating operations

-  Indicates the action (pushing, turning, etc.) used to operate switches and other devices.
-  Indicates the outcome of an operation (e.g. a lid opens).

Before driving

1

1-1. Key information		1-4. Opening and closing the windows and moon roof	
Keys	28	Power windows	96
1-2. Opening, closing and locking the doors		Moon roof	100
Smart key system	30	Sunshade	104
Wireless remote control	45	1-5. Refueling	
Side doors	50	Opening the fuel tank cap	105
Back door	56	1-6. Theft deterrent system	
1-3. Adjustable components (seats, mirrors, steering wheel)		Engine immobilizer system	109
Front seats	67	Alarm	112
Rear seats	70	Theft prevention labels (U.S.A.)	116
Driving position memory	73	1-7. Safety information	
Head restraints	78	Correct driving posture	117
Seat belts	81	SRS airbags	119
Steering wheel	88	Front passenger occupant classification system	134
Inside rear view mirror	89	Child restraint systems	140
Outside rear view mirrors	92	Installing child restraints	146

1-1. Key information

Keys

The following keys are provided with the vehicle.

► Vehicles with smart key system

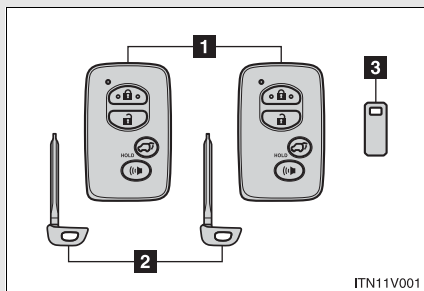

1 Electronic keys

- Operating the smart key system (→P. 30)
- Operating the wireless remote control function (→P. 45)

2 Mechanical keys

3 Key number plate

► Vehicles without smart key system

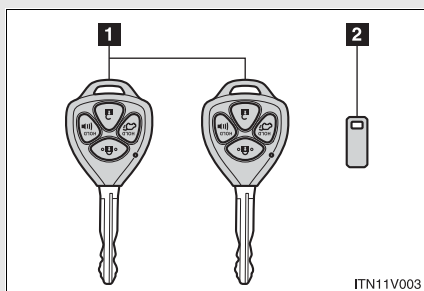

1 Keys

Operating the wireless remote control function (→P. 46)

2 Key number plate

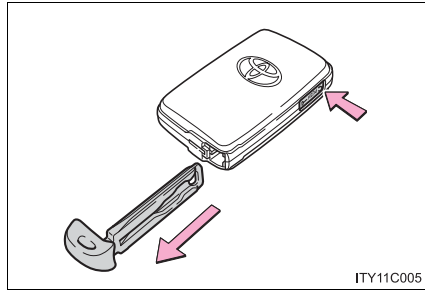
Using the mechanical key (vehicles with smart key system)

Take out the mechanical key.

After using the mechanical key, store it in the electronic key. Carry the mechanical key together with the electronic key. If the electronic key battery depletes or entry function does not operate properly, you will need the mechanical key. (→P. 595)

1
Before driving

■ **Key number plate**

Keep the plate in a safe place such as your wallet, not in the vehicle. In the event that a key is lost, a new key can be made at your Toyota dealer using the key number plate. (→P. 594)

■ **When riding in an aircraft**

When bringing a key onto an aircraft, make sure you do not press any buttons on the key while inside the aircraft cabin. If you are carrying a key in your bag etc., ensure that the buttons are not likely to be pressed accidentally. Pressing a button may cause the key to emit radio waves that could interfere with the operation of the aircraft.

 **NOTICE**

■ **To prevent key damage**

- Do not subject the keys to strong shocks, expose them to high temperatures by placing them in direct sunlight, or get them wet.
- Do not expose the keys to electromagnetic materials or attach any material that blocks electromagnetic waves to the key surface.
- Do not disassemble the key.

1-2. Opening, closing and locking the doors Smart key system*

The following operations can be performed simply by carrying the electronic key on your person, for example in your pocket.
(The driver should always carry the electronic key.)

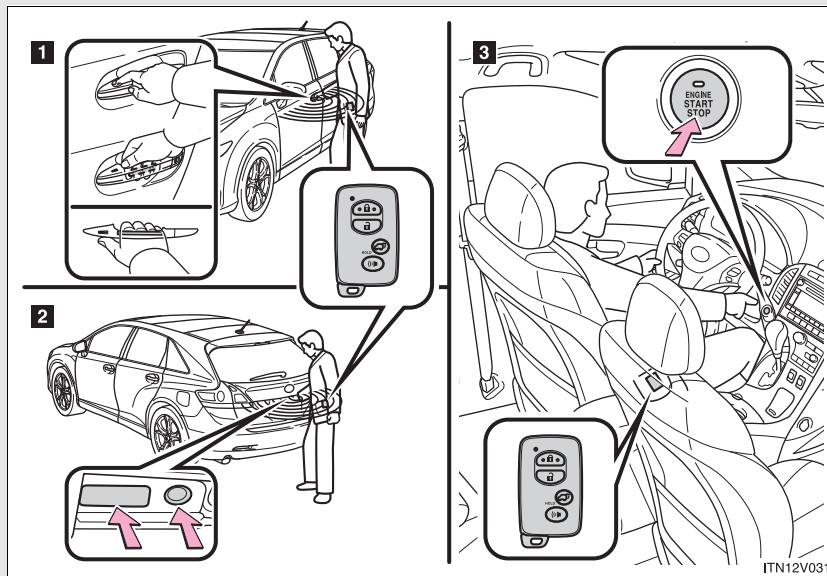

- 1** Locks and unlocks the doors (→P. 31)
- 2** Locks and unlocks the doors (→P. 32)
- 3** Starts and stops the engine (→P. 173)

*: If equipped

Unlocking and locking the doors

► Front door handle

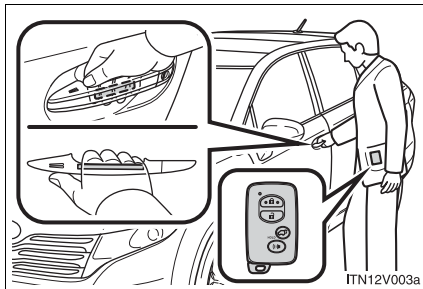

Grip the driver's door handle to unlock the door. Grip the passenger's door handle to unlock all the doors.*

Make sure to touch the sensor on the back of the handle.

The doors cannot be unlocked for 3 seconds after the doors are locked.

*: The door unlock settings can be changed.(→P. 36)

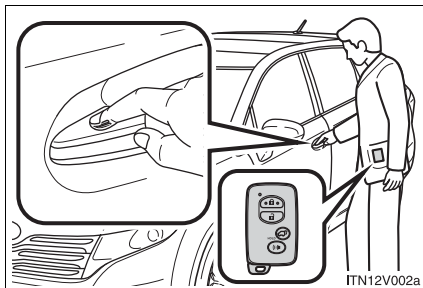

Touch the sensor area to lock the doors.

1

Before driving

1-2. Opening, closing and locking the doors

► Back door

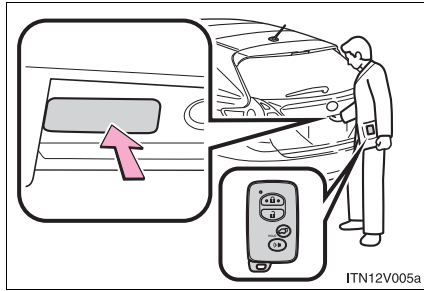

Press the unlock button to unlock the door.

The door cannot be unlocked for 3 seconds after the door is locked.

Lock the back door again when you leave the vehicle. The back door will not lock automatically after it has been opened and then closed.

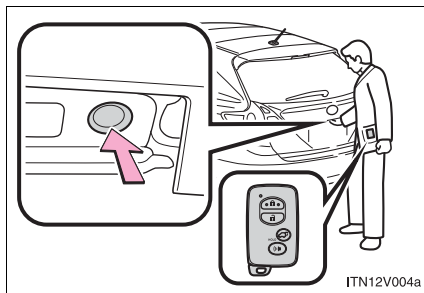

Press the lock button to lock the doors.

Antenna location and effective range

Antenna location

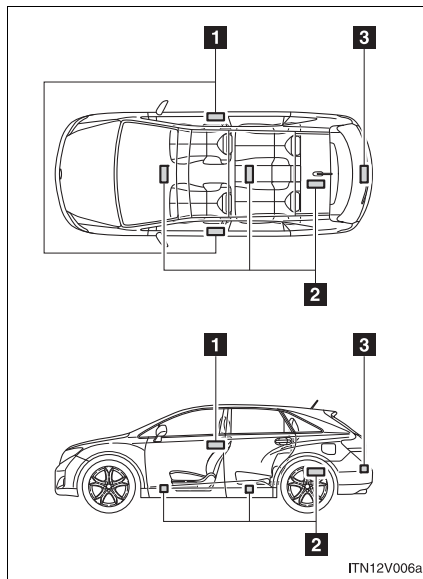

- 1** Antennas outside cabin
- 2** Antennas inside cabin
- 3** Antenna outside luggage compartment

1
Before driving

1-2. Opening, closing and locking the doors

■ Effective range (areas within which the electronic key is detected)

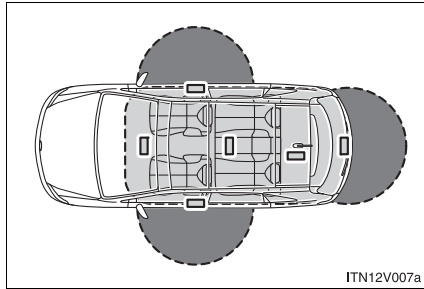

- When locking or unlocking the doors

The system can be operated when the electronic key is within about 2.3 ft. (0.7 m) of an outside door handle.

- When starting the engine or changing “ENGINE START STOP” switch modes

The system can be operated when the electronic key is inside the vehicle.

■ Operation signals

A buzzer sounds and the emergency flashers flash to indicate that the doors have been locked/unlocked. (Locked: Once; Unlocked: Twice)

■ When the door cannot be locked using the topside sensor area

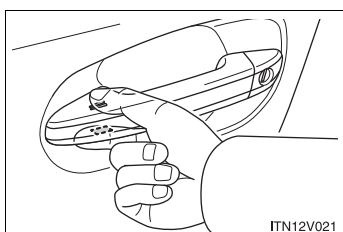

If the door will not lock even when the topside sensor area is touched, try touching both the topside and underside sensor areas at the same time.

■ Conditions affecting operation

The smart key system uses weak radio waves. In the following situations, the communication between the electronic key and the vehicle may be affected, preventing the smart key system and wireless remote control from operating properly. (Way of coping →P. 595)



- When the electronic key battery is depleted
- Near a TV tower, electric power plant, gas station, radio station, large display, airport or other facility that generates strong radio waves or electrical noise
- When carrying a portable radio, cellular phone, cordless phone or other wireless communication devices
- When the electronic key has come into contact with, or is covered by a metallic object
- When multiple electronic keys are in the vicinity
- When carrying or using the electronic key together with the following devices that emit radio waves
 - Another vehicle's electronic key
 - A wireless key that emits radio waves
 - Personal computer
- If window tint with a metallic content or metallic objects are attached to the rear window

1-2. Opening, closing and locking the doors



■ Switching the door unlock function

It is possible to set which doors the entry function unlocks.

STEP 1 Turn the “ENGINE START STOP” switch OFF.

STEP 2 When the indicator on the key surface is turned off, press and hold  or  for approximately 5 seconds while pressing  on the key.

The setting changes each time an operation is performed, as shown below.
(When changing the setting continuously, release the buttons, wait for at least 5 seconds, and repeat **STEP 2**.)

Multi-information display (TFT type only)	Unlocking function	Beep
	Hold the driver's door handle to unlock only the driver's door.	Exterior: Beeps three times Interior: Pings once
	Hold the front passenger's door handle to unlock all doors.	
	Hold either front door handle to unlock all doors.	Exterior: Beeps twice Interior: Pings once

STEP 3 For vehicles equipped with an alarm:

To prevent unintended triggering of the alarm, unlock the doors using the wireless remote control and open and close a door once after the settings have been changed. (If a door is not opened within 60 second after  is pressed, the doors will be locked again and the alarm will automatically be set.)

In case that the alarm is triggered, immediately stop the alarm.
(→P. 112)

■ **Battery-saving function**

In the following circumstances, the entry function is disabled in order to prevent the vehicle and electronic key batteries from discharging.

- When the entry function has not been used for 2 weeks or more
- When the electronic key has been left within approximately 3 ft. (1 m) of the vehicle for 10 minutes or more

The system will resume operation when...

- The vehicle is locked using the door handle lock switch.
- The vehicle is locked/unlocked using the wireless remote control function (→P. 45) or the mechanical key. (→P. 595)

■ **Electronic key battery depletion**

- The standard battery life is 1 to 2 years. (The battery becomes depleted even if the electronic key is not used.) If the smart key system or the wireless remote control function does not operate, or the detection area becomes smaller, the battery may be depleted. Replace the battery when necessary. (→P. 523)
- If the battery becomes low, an alarm will sound in the cabin when the engine stops. (→P. 40)
- To avoid serious deterioration, do not leave the electronic key within 3 ft. (1 m) of the following electrical appliances that produce a magnetic field.
 - TVs
 - Personal computers
 - Recharging cellular phones or cordless phones
 - Table lamps

1-2. Opening, closing and locking the doors

■ To operate the system properly

Make sure to carry the electronic key when operating the system. Do not get the electronic key too close to the vehicle when operating the system from outside of the vehicle.

Depending on the position and holding condition of the electronic key, the key may not be detected correctly and the system may not operate properly. (The alarm may go off accidentally, or the door lock prevention may not function.)

■ Note for the entry function

- Even when the electronic key is within the effective range (detection areas), the system may not operate properly in the following cases.
 - The electronic key is too close to the window or outside door handle, near the ground, or in a high place when the doors are locked or unlocked.
 - The electronic key is near the ground or in a high place, or too close to the rear bumper center when the back door is locked or unlocked.
 - The electronic key is on the instrument panel, floor or in the glove box when the engine is started or "ENGINE START STOP" switch modes are changed.
- Do not leave the electronic key on top of the instrument panel or near the door pockets when exiting the vehicle. Depending on the radio wave reception conditions, it may be detected by the antenna outside the cabin and the door will become lockable from the outside, possibly trapping the electronic key inside the vehicle.
- As long as the electronic key is within the effective range, the doors may be locked or unlocked by anyone.

1-2. Opening, closing and locking the doors

- Even if the electronic key is not inside the vehicle, it may be possible to start the engine if the electronic key is near the window.
- The doors may unlock or lock if a large amount of water splashes on the door handle, such as in the rain or in a car wash when the electronic key is within the effective range. (The doors will automatically be locked after approximately 60 seconds if the doors are not opened and closed.)
- If the key is kept near the vehicle while it is being washed, water applied to a door handle may cause the door to lock and unlock repeatedly. In this event, place the key in a location 6 ft. (2 m) or more from the vehicle, taking care not to lose the key.
- If the key is inside the vehicle while it is being washed, water applied to a door handle may cause a buzzer to sound. In this event, locking all doors will cause the buzzer to stop sounding.
- It may not be possible to lock the doors if the sensor area is covered by mud, ice, snow etc. In this event, try locking again after cleaning the area, or lock by touching the sensor area on the underside of the door handle.
- Gripping the door handle when wearing a glove may not unlock or lock the door.
- If the wireless remote control is used to lock the doors when the electronic key is near the vehicle, there is a possibility that the door may not be unlocked by the smart key system. (Use the wireless remote control to unlock the doors.)
- A sudden approach to the effective range or door handle operation may prevent the doors from being unlocked. In this case, return the door handle to the original position and check that the doors unlock before pulling the door handle.

1

Before driving

1-2. Opening, closing and locking the doors

■ When the vehicle is not driven for extended periods

To prevent theft of the vehicle, do not leave the electronic key within 6 ft. (2 m) of the vehicle.

■ Security feature

If a door is not opened within approximately 60 seconds after the vehicle is unlocked, the security feature automatically locks the vehicle again.

■ Alarms and warning indicators

A combination of exterior and interior alarms as well as warnings displayed on the multi-information display are used to prevent theft of the vehicle and unforeseeable accidents resulting from erroneous operation. Perform the appropriate correction procedure described in the following table.

Alarm	Situation	Correction procedure
Exterior alarm sounds once for 10 seconds	An attempt was made to lock the doors using the entry function while the electronic key was still inside the passenger compartment	Retrieve the electronic key from the passenger compartment and lock the doors again
Exterior alarm sounds once for 10 seconds	An attempt was made to exit the vehicle and lock the doors without first turning the "ENGINE START STOP" switch OFF	Turn the "ENGINE START STOP" switch OFF and lock the doors again
Exterior alarm sounds once for 10 seconds	An attempt was made to lock the vehicle while a door is open	Close all of the doors and lock the doors again

1-2. Opening, closing and locking the doors

Alarm	Situation	Correction procedure
Interior alarm pings continuously*1	The "ENGINE START STOP" switch was turned to ACCESSORY mode while the driver's door was open (or the driver's door was opened while the "ENGINE START STOP" switch was in ACCESSORY mode)	Turn the "ENGINE START STOP" switch OFF and close the driver's door
	The "ENGINE START STOP" switch was turned OFF while the driver's door was open	Close the driver's door
Interior alarm sounds continuously*1	When the "ENGINE START STOP" switch is in IGNITION ON or ACCESSORY mode, an attempt was made to open the door and exit the vehicle, and the shift lever was not in "P"	Shift the shift lever to "P" and turn the "ENGINE START STOP" switch OFF
Interior and exterior alarms sound continuously*1	When the "ENGINE START STOP" switch is in IGNITION ON or ACCESSORY mode, the driver's door was closed after the key was carried outside the vehicle, and the shift lever not in "P"	Shift the shift lever to "P", turn the "ENGINE START STOP" switch OFF and close the driver's door again

1

Before driving

1-2. Opening, closing and locking the doors

Alarm	Situation	Correction procedure
Interior alarm pings once ^{*1}	The electronic key has a low battery	Replace the electronic key battery
	An attempt was made to start the engine without the electronic key being present, or the electronic key was not functioning normally	Start the engine with the electronic key present ^{*2}
Interior alarm pings once and exterior alarm sounds 3 times ^{*1}	The driver's door was closed after the key was carried outside the vehicle, and the "ENGINE START STOP" switch was not turned OFF	Turn the "ENGINE START STOP" switch OFF and close the driver's door again
	An occupant carried the electronic key outside the vehicle and closed the door while the "ENGINE START STOP" switch was not OFF	Bring the electronic key back into the vehicle

^{*1}: A message will be shown on the multi-information display in the instrument cluster.

^{*2}: If the engine does not start when the electronic key is inside the vehicle, the electronic key battery may be depleted or there may be difficulties receiving signal from the key. (→P. 595)

■ **If the smart key system does not operate properly**

- Locking and unlocking the doors: Use the mechanical key. (→P. 595)
- Starting the engine (→P. 596)

■ **When the electronic key battery is fully depleted**

→P. 523

■ **Customization**

Settings (e.g. smart key system) can be changed.
(Customizable features →P. 645)

■ **Certification for the smart key system**

- ▶ For vehicles sold in the U.S.A.

FCC ID: HYQ14ACX FCC ID: HYQ14ADF
FCC ID: HYQ13CZD FCC ID: HYQ13CZE

NOTE:

This device complies with part 15 of the FCC Rules. Operation is subject to the following two conditions: (1) This device may not cause harmful interference, and (2) this device must accept any interference received, including interference that may cause undesired operation.

FCC WARNING:

Changes or modifications not expressly approved by the party responsible for compliance could void the user's authority to operate the equipment.

1-2. Opening, closing and locking the doors

- ▶ For vehicles sold in Canada

NOTE:

Operation is subject to the following two conditions: (1) this device may not cause interference, and (2) this device must accept any interference, including interference that may cause undesired operation of the device.

 **CAUTION**

■ Caution regarding interference with electronic devices

- People with implantable cardiac pacemakers, cardiac resynchronization therapy-pacemakers or implantable cardioverter defibrillators should keep away from the smart key system antennas. (→P. 33)

The radio waves may affect the operation of such devices. If necessary, the entry function can be disabled. Ask your Toyota dealer for details, such as the frequency of radio waves and timing of the emitted radio waves. Then, consult your doctor to see if you should disable the entry function.

- Users of any electrical medical device other than implantable cardiac pacemakers, cardiac resynchronization therapy-pacemakers or implantable cardioverter defibrillators should consult the manufacturer of the device for information about its operation under the influence of radio waves. Radio waves could have unexpected effects on the operation of such medical devices.

Ask your Toyota dealer for details for disabling the smart key system.

1-2. Opening, closing and locking the doors Wireless remote control

The wireless remote control can be used to lock and unlock the vehicle from outside the vehicle.

► Vehicles with smart key system

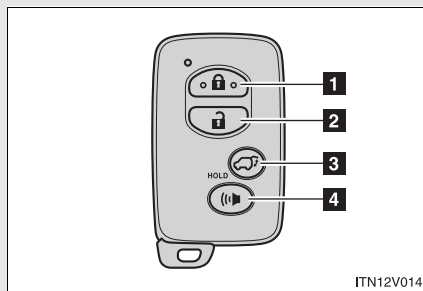

1 Locks all doors

2 Unlocks all doors

Pressing the button unlocks the driver's door. Pressing the button again within 3 seconds unlocks the other doors.

3 Pressing and holding: Opens and closes the power back door (if equipped)

4 Pressing and holding: Sounds alarm (→P. 115)

1

Before driving

1-2. Opening, closing and locking the doors

► Vehicles without smart key system

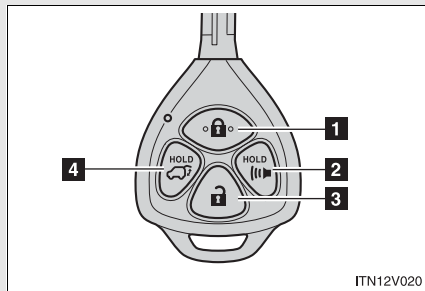

1 Locks all doors

2 Pressing and holding:
Sounds alarm (→P. 115)

3 Unlocks all doors

Pressing the button unlocks the driver's door. Pressing the button again within 3 seconds unlocks the other doors.

4 Pressing and holding:
Opens and closes the power back door (if equipped)

■ Operation signals

Doors: A buzzer sounds and the emergency flashers flash to indicate that the doors have been locked/unlocked. (Locked: Once; Unlocked: Twice)

Back door: A buzzer sounds and the emergency flashers flash twice to indicate that the back door has been opened/closed.

■ **Door lock buzzer**

If a door or back door is not fully closed, a buzzer sounds continuously for 10 seconds if an attempt to lock the door is made. Fully close the door to stop the buzzer, and lock the vehicle once more.

■ **Security feature**

→P. 40

■ **Alarm**

Using the wireless remote control to lock the door will set the alarm system. (→P. 112)

■ **Key battery depletion**

- ▶ Vehicles with smart key system

→P. 37

- ▶ Vehicles without smart key system

The standard battery life is 1 to 2 years. (The battery becomes depleted even if the key is not used.) If the wireless remote control function does not operate, the battery may be depleted. Replace the battery when necessary. (→P. 524)

■ **If the wireless remote control does not operate properly**

- ▶ Vehicles with smart key system

Locking and unlocking the doors: Use the mechanical key. (→P. 595)

- ▶ Vehicles without smart key system

Locking and unlocking the doors: Use the key. (→P. 50)

1-2. Opening, closing and locking the doors

■ Conditions affecting operation

▶ Vehicles with smart key system

→P. 35

▶ Vehicles without smart key system

The wireless remote control function may not operate normally in the following situations.

- Near a TV tower, radio station, electric power plant, airport or other facility that generates strong radio waves
- When carrying a portable radio, cellular phone or other wireless communication device
- When multiple wireless keys are in the vicinity
- When the wireless key has come into contact with, or is covered by a metallic object
- When a wireless key (that emits radio waves) is being used nearby
- When the wireless key has been left near an electrical appliance such as a personal computer

■ Customization

Settings (e.g. 2-step unlocking function) can be changed.
(Customizable features →P. 645)

■ Reversing the operation of the power back door (if equipped)

Pressing the wireless remote control switch again while the power back door is operating will cause the operation to reverse. However, the reverse operation cannot be performed for the first second after automatic operation starts, even if the wireless remote control switch is pressed again.

■ **Certification for wireless remote control**

- ▶ For vehicles sold in the U.S.A.

NOTE:

This device complies with Part 15 of the FCC Rules. Operation is subject to the following two conditions: (1) this device may not cause harmful interference, and (2) this device must accept any interference received, including interference that may cause undesired operation.

NOTICE:

This equipment has been tested and found to comply with the limits for a Class B digital device, pursuant to Part 15 of the FCC Rules. These limits are designed to provide reasonable protection against harmful interference in a residential installation. This equipment generates, uses and can radiate radio frequency energy and, if not installed and used in accordance with the instructions, may cause harmful interference to radio communications. However, there is no guarantee that interference will not occur in a particular installation. If this equipment does cause harmful interference to radio or television reception, which can be determined by turning the equipment off and on, the user is encouraged to try to correct the interference by one or more of the following measures:

- Reorient or relocate the receiving antenna.
- Increase the separation between the equipment and receiver.
- Connect the equipment into an outlet on a circuit different from that to which the receiver is connected.
- Consult the dealer or an experienced radio/TV technician for help.

FCC WARNING:

Changes or modifications not expressly approved by the party responsible for compliance could void the user's authority to operate the equipment.

- ▶ For vehicles sold in Canada

NOTE:

Operation is subject to the following two conditions: (1) this device may not cause interference, and (2) this device must accept any interference, including interference that may cause undesired operation of the device.

1-2. Opening, closing and locking the doors Side doors

The vehicle can be locked and unlocked using the entry function, wireless remote control, key or door lock switch.

■ **Entry function (vehicles with smart key system)**

→P. 30

■ **Wireless remote control**

→P. 45

■ **Key**

▶ Vehicles with smart key system

The doors can also be locked and unlocked with the mechanical key. (→P. 595)

▶ Vehicles without smart key system

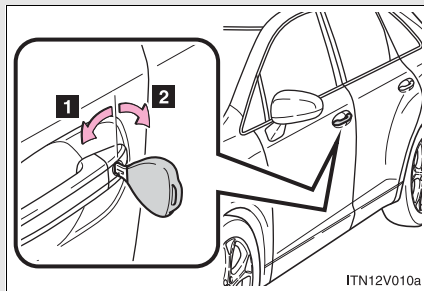

1 Locks all doors

2 Unlocks all doors

Turning the key unlocks the driver's door. Turning the key again within 3 seconds unlocks the other doors.

■ **Door lock switch**

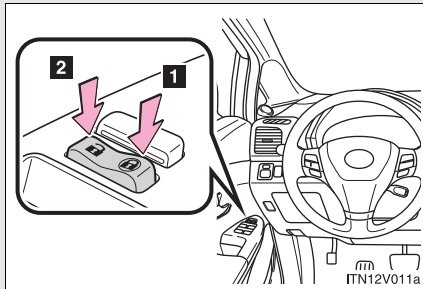

- 1** Locks all doors
- 2** Unlocks all doors

■ **Inside lock button**

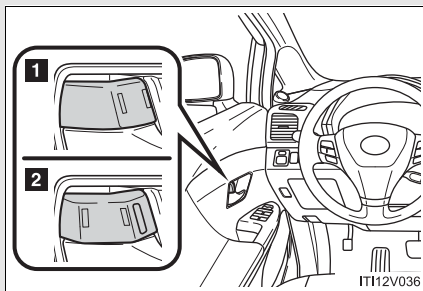

- 1** Locks the door
- 2** Unlocks the door

The front doors can be opened by pulling the inside handles even if the lock buttons are in the lock position.

1

Before driving

Locking the driver's doors from the outside without a key

STEP 1 Move the inside lock button to the lock position.

STEP 2 Close the door.

► Vehicles with smart key system

The door cannot be locked if the “ENGINE START STOP” switch is in ACCESSORY or IGNITION ON mode, or the electronic key is left inside the vehicle.

Depending on the position of the electronic key, the key may not be detected correctly and the door may be locked.

► Vehicles without smart key system

The door cannot be locked if either front door is open and the key is in the engine switch.

Rear door child-protector lock

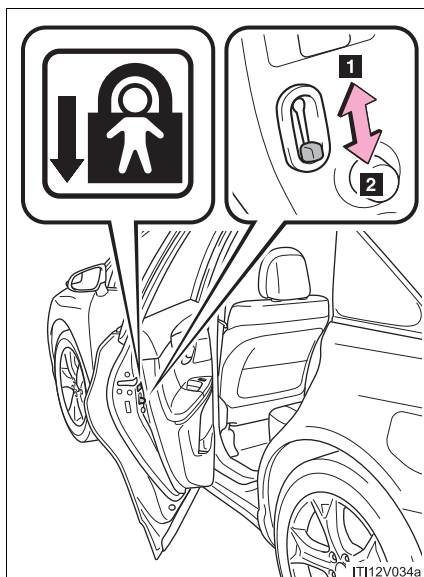

The door cannot be opened from inside the vehicle when the lock is set.

1 Unlock

2 Lock

These locks can be set to prevent children from opening the rear doors. Push down on each rear door switch to lock both rear doors.

Automatic door locking and unlocking systems

The following functions can be set or canceled:

Function	Operation
Shift position linked door locking function	Shifting the shift lever out of "P" locks all doors.
Shift position linked door unlocking function	Shifting the shift lever to "P" unlocks all doors.
Speed linked door locking function	All doors are locked when the vehicle speed is approximately 12 mph (20 km/h) or higher.
Driver's door linked door unlocking function	All doors are unlocked when the driver's door is opened within 10 seconds after turning the "ENGINE START STOP" switch OFF.

1

Before driving

■ Setting and canceling the functions

- ▶ Vehicles with TFT type multi-information display

The function settings can be changed using the multi-information display. (→P. 652)

- ▶ Vehicles with LCD type multi-information display

To switch between setting and canceling, follow the procedure below:

1-2. Opening, closing and locking the doors

STEP 1 Vehicles with smart key system:

Close all the doors and switch the “ENGINE START STOP” switch to IGNITION ON mode. (Perform STEP 2 within 20 seconds.)

Vehicles without smart key system:

Close all the doors and switch the engine switch to the “ON” position. (Perform STEP 2 within 20 seconds.)

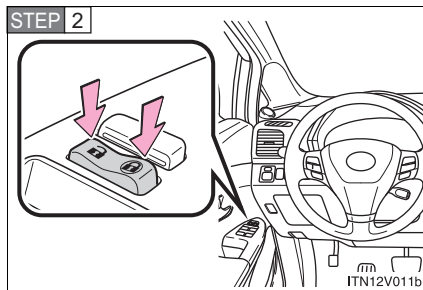

Shift the shift lever to “P” or “N”, press and hold the driver’s door lock switch (🔒 or 🔓) for about 5 seconds then release.

The shift lever and switch positions corresponding to the desired function to be set are shown as follows.

Use the same procedure to cancel the function.

Function	Shift lever position	Driver’s door lock switch position
Shift position linked door locking function	“P”	🔒
Shift position linked door unlocking function		🔓
Speed linked door locking function	“N”	🔒
Driver’s door linked door unlocking function		🔓

When the setting or canceling operation is complete, all doors are locked and then unlocked.

■ **Impact detection door lock release system**

In the event that the vehicle is subject to a strong impact, all the doors are unlocked.

Depending on the force of the impact or the type of accident, however, the system may not operate.

■ **Customization**

Settings (e.g. unlocking function using a key) can be changed.
(Customizable features →P. 645)

1

Before driving

 **CAUTION**

■ **To prevent an accident**

Observe the following precautions while driving the vehicle.

Failing to do so may result in a door opening and an occupant falling out, resulting in death or serious injury.

- Always use a seat belt.
- Always lock all doors.
- Ensure that all doors are properly closed.
- Do not pull the inside handle of the doors while driving.
The doors may be opened and the passengers are thrown out of the vehicle and it may result in death or serious injury.
Be especially careful for the front doors, as the doors may be opened even if the inside lock buttons are in locked position.
- Set the rear door child-protector locks when children are seated in the rear seat.

1-2. Opening, closing and locking the doors

Back door

The back door can be opened using the back door opener. The back door can be locked and unlocked using the entry function (vehicles with smart key system), wireless remote control or door lock switch. In addition, the power back door (if equipped) can be opened using the power back door switch or wireless remote control.

■ Unlocking and locking the back door

- ▶ Entry function (vehicles with smart key system)
→P. 30
- ▶ Wireless remote control
→P. 45
- ▶ Door lock switch
→P. 50

■ Opening the back door from outside the vehicle

- ▶ Back door opener

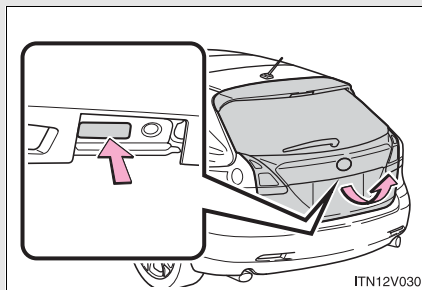

Raise the back door while pushing up the back door opener switch.

- ▶ Wireless remote control (vehicles with power back door)
→P. 45

■ **Opening/closing the back door from inside the vehicle (vehicles with power back door)**

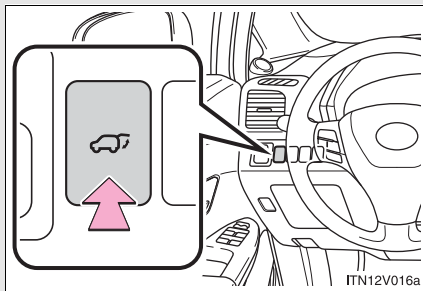

Push and hold the switch to open/close.

Pressing the switch again while the power back door is operating will cause the operation to reverse.

However, the reverse operation cannot be performed for the first second after pressing the switch to operate the door.

1

Before driving

When closing the back door

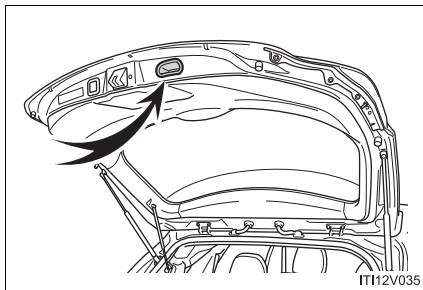

Lower the back door using the back door handle, and make sure to push the back door down from the outside to close it.

Be careful not to pull the back door sideways when closing the back door with the handle.

Power back door switch (vehicles with power back door)

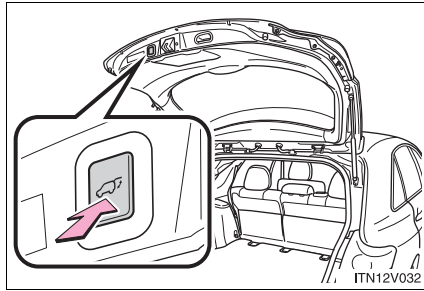

Push the switch to close.

Pressing the switch again while the power back door is closing will cause it to open again.

However, the reverse operation cannot be performed for the first second after pressing the switch to close the door.

The back door can be opened even if it is locked. Lock the back door again when you leave the vehicle. The back door will not lock automatically after it has been opened and then closed.

A buzzer sounds and the emergency flashers flash twice to indicate that the back door has been opened/closed.

Canceling the power back door system (vehicles with power back door)

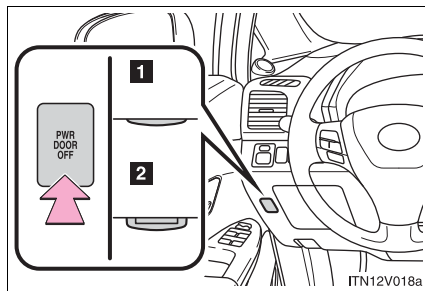

Turn the main switch off to disable the power back door system.

1 Inoperative

2 Operative

The back door cannot be operated even with the wireless remote control or power back door switch.

A buzzer will sound twice if the power back door switch is pressed while the power back door system is inoperative.

1

Before driving

■ **The power back door can be opened/closed when (vehicles with power back door)**

▶ Vehicles with smart key system

- The “ENGINE START STOP” switch is in IGNITION ON mode, and the shift lever is in “P”.
- The “ENGINE START STOP” switch is in OFF or ACCESSORY mode.

▶ Vehicles without smart key system

- The engine switch is in the “ON” position, and the shift lever is in “P”.
- The engine switch is in the “LOCK” or “ACC” position.

■ **Jam protection function (vehicles with power back door)**

If anything obstructs the power back door while it is closing/opening, the back door will automatically operate in the opposite direction.

■ **If the power back door does not work (vehicles with power back door)**

The back door must be initialized. To initialize, close the back door completely by hand.

■ **Back door closer**

In the event that the back door is left slightly open, the back door closer will automatically close it to the fully closed position.

 CAUTION

■ **While driving**

- Keep the back door closed while driving.
If the back door is left open, it may hit near-by objects while driving or luggage may be unexpectedly thrown out, causing an accident.
In addition, exhaust gases may enter the vehicle, causing death or a serious health hazard. Make sure to close the back door before driving.
- Before driving the vehicle, make sure that the back door is fully closed. If the back door is not fully closed, it may open unexpectedly while driving, causing an accident.
- Never let anyone sit in the luggage compartment. In the event of sudden braking or a collision, they are susceptible to death or serious injury.

■ **When children are in the vehicle**

Observe the following precautions.

Failure to do so may result in death or serious injury.

- Do not allow children to play in the luggage compartment.
If a child is accidentally locked in the luggage compartment, they could have heat exhaustion or other injuries.
- Do not allow a child to open or close the back door.
Doing so may cause the back door to move unexpectedly, or cause the child's hands, head, or neck to be caught by the closing back door.

1

Before driving

1-2. Opening, closing and locking the doors

CAUTION

■ Operating the back door

Observe the following precautions.

Failure to do so may cause parts of the body to be caught, resulting in death or serious injury.

- Remove any heavy loads, such as snow and ice, from the back door before opening it. Failure to do so may cause the back door to suddenly shut again after it is opened.
- When opening or closing the back door, thoroughly check to make sure the surrounding area is safe.
- If anyone is in the vicinity, make sure they are safe and let them know that the back door is about to open or close.
- Use caution when opening or closing the back door in windy weather as it may move abruptly in strong wind.

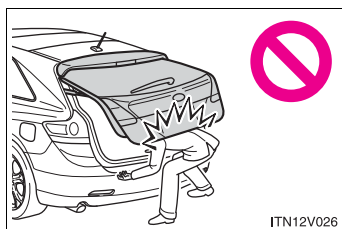

- The back door may suddenly shut if it is not opened fully. It is more difficult to open or close the back door on an incline than on a level surface, so beware of the back door unexpectedly opening or closing by itself. Make sure that the back door is fully open and secure before using the luggage compartment.

! CAUTION

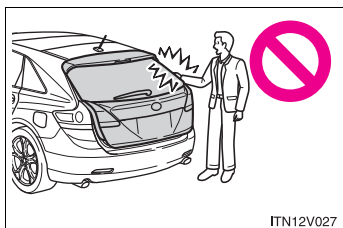

- When closing the back door, take extra care to prevent your fingers etc. from being caught.
- When closing the back door, make sure to press it lightly on its outer surface. If the back door handle is used to fully close the back door, it may result in hands or arms being caught.

- Do not pull on the back door damper stay to close the back door, and do not hang on the back door damper stay. Doing so may cause hands to be caught or the back door damper stay to break, causing an accident.
- If a bicycle carrier or similar heavy object is attached to the back door, it may suddenly shut again after being opened, causing someone's hands, head or neck to be caught and injured. When installing an accessory part to the back door, using a genuine Toyota part is recommended.

■ Back door closer

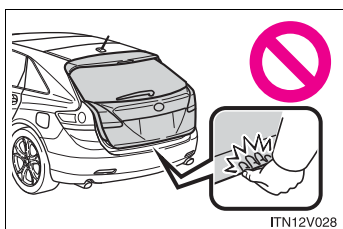

- In the event that the back door is left slightly open, the back door closer will automatically close it to the fully closed position. It takes several seconds before the back door closer begins to operate. Be careful not to catch fingers or anything else in the back door, as this may cause bone fractures or other serious injuries.

- Use caution when using the back door closer as it still operates when the power back door system is cancelled.

 CAUTION

■ **Power back door (if equipped)**

Observe the following precautions when operating the power back door. Failure to do so may cause death or serious injury.

- Check the safety of the surrounding area to make sure there are no obstacles or anything that could cause any of your belongings to get caught.
- If anyone is in the vicinity, make sure they are safe and let them know that the back door is about to open or close.
- On an incline, the back door may suddenly shut after it opens. Make sure the back door is fully open and secure.
- In the following situations, the power back door may detect an abnormality and automatic operation may be stopped. In this case, the back door has to be operated manually. Take extra care when on an incline, as the back door may open or close abruptly.
 - When the back door contacts an obstacle
 - Vehicles with smart key system:
When the battery voltage suddenly drops, such as when the “ENGINE START STOP” switch is turned to IGNITION ON mode or the engine is started during automatic operation
 - Vehicles without smart key system:
When the battery voltage suddenly drops, such as when the engine switch is turned to the “ON” position or the engine is started during automatic operation
- If a bicycle carrier or similar heavy object is attached to the back door, the power back door may not operate, causing itself to malfunction, or the back door may suddenly shut again after being opened, causing someone’s hands, head or neck to be caught and injured. When installing an accessory part to the back door, using a genuine Toyota part is recommended.

⚠ CAUTION

■ Jam protection function (vehicles with power back door)

Observe the following precautions.
Failure to do so may cause death or serious injury.

- Never use any part of your body to intentionally activate the jam protection function.
- The jam protection function may not work if something gets caught just before the back door fully closes. Be careful not to catch fingers or anything else.
- The jam protection function may not work depending on the shape of the object that is caught. Be careful not to catch fingers or anything else.

1

Before driving

⚠ NOTICE

■ Back door damper stays

The back door is equipped with damper stays that hold the back door in place.

Observe the following precautions.
Failure to do so may cause damage to the back door damper stay, resulting in malfunction.

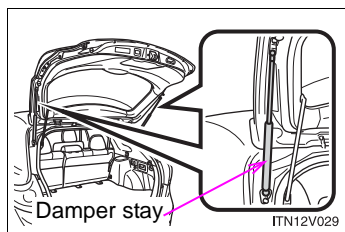

- Do not attach any foreign objects, such as stickers, plastic sheets, or adhesives to the damper stay rod.
- Do not touch the damper stay rod with gloves or other fabric items.
- Do not attach any accessories other than genuine Toyota parts to the back door.
- Do not place your hand on the damper stay or apply lateral forces to it.

1-2. Opening, closing and locking the doors

NOTICE

■ **To prevent back door closer malfunction**

Do not apply excessive force to the back door while the back door closer is operating.

■ **To prevent damage to the power back door (vehicles with power back door)**

- Make sure that there is no ice between the back door and frame that would prevent movement of the back door. Operating the power back door when excessive load is present on the back door may cause a malfunction.
- Do not apply excessive force to the back door while the power back door is operating.
- Take care not to damage the sensors (installed on the right and left edges of the power back door) with a knife or other sharp object. If the sensor is disconnected, the power back door will not operate in automatic operation.

1-3. Adjustable components (seats, mirrors, steering wheel) Front seats

► Power seat

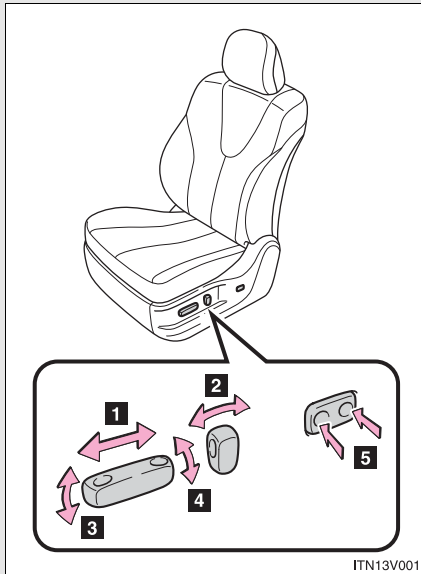

- 1** Seat position fore/aft control switch
- 2** Seatback angle control switch
- 3** Seat cushion (front) angle control switch (driver's side only)
- 4** Vertical height control switch (driver's side only)
- 5** Lumbar support control switch

► Manual seat



- 1** Seat position fore/aft adjustment lever
- 2** Seatback angle adjustment lever

1
Before driving

1-3. Adjustable components (seats, mirrors, steering wheel)

Active head restraints

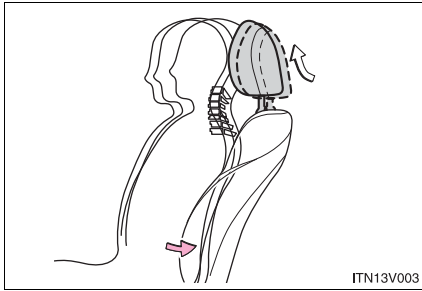

When the occupant's lower back presses against the seatback during a rear-end collision, the head restraint moves slightly forward and upward to help reduce the risk of whiplash on the seat occupant.

■ **Active head restraints**

Even small forces applied to the seatback may cause the head restraint to move. Pushing up a locked head restraint forcibly may make the inner structure of the head restraint appear. This does not indicate a problem.

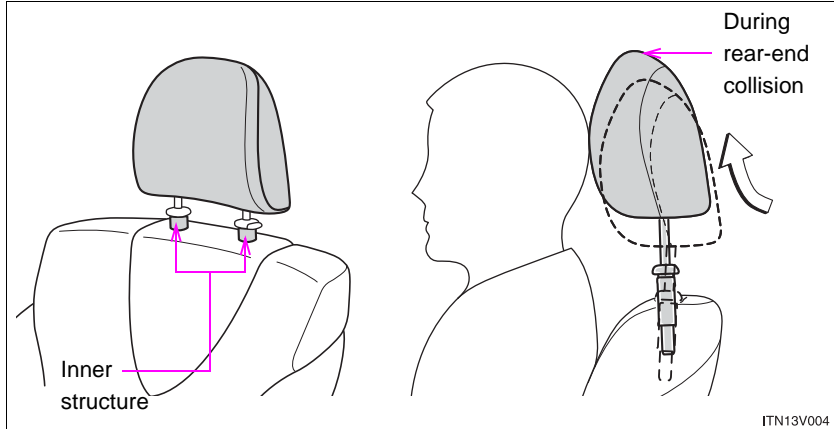

1-3. Adjustable components (seats, mirrors, steering wheel)

CAUTION

■ Seat adjustment

- Be careful that the seat does not hit passengers or luggage.
- Do not recline the seat more than necessary when the vehicle is in motion to reduce the risk of sliding under the lap belt.
If the seat is too reclined, during an accident the lap belt may slide past the hips and apply restraint forces directly to the abdomen or your neck may contact the shoulder belt, increasing the risk of death or serious injury.
- Manual seat only: After adjusting the seat, make sure that the seat is locked in position.

1

Before driving

1-3. Adjustable components (seats, mirrors, steering wheel) Rear seats

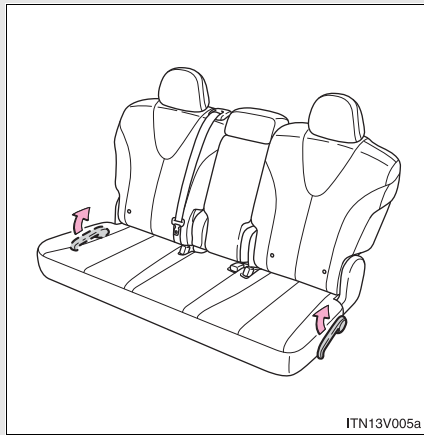

Seatback angle adjustment lever

Pull up the lever until the lock is completely released.

Folding down the rear seatbacks

■ Before folding down the rear seatbacks

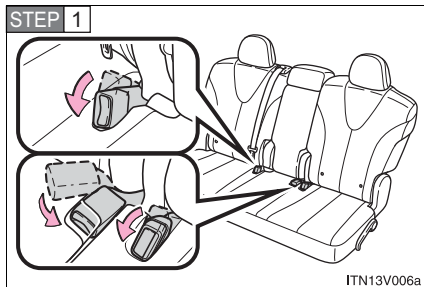

Stow the seat belt buckles and lower the head restraints to the lowest position.

1-3. Adjustable components (seats, mirrors, steering wheel)

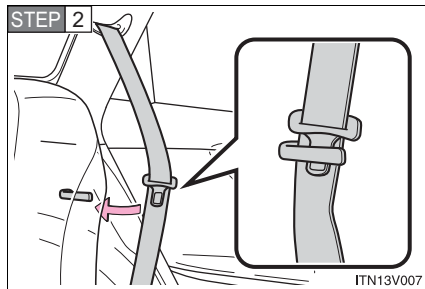

Pass the outer seat belts and plates through the seat belt hangers.

This prevents the shoulder belt from being damaged.

Make sure that the seat belts are removed from the hangers before using them.

■ Folding down the rear seatbacks

► From inside

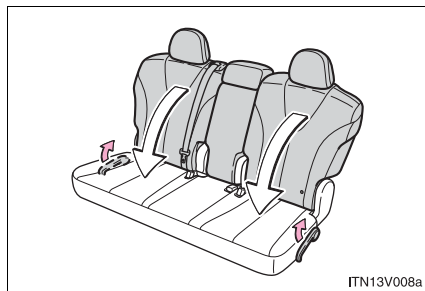

Fold down the seatback while pulling the seatback angle adjustment lever.

Pull up the lever until the lock is completely released.

► From outside

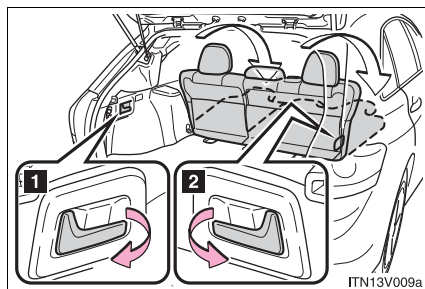

Pull the lever.

1 For left side rear seatback

2 For right side and center rear seatback

1
Before driving

1-3. Adjustable components (seats, mirrors, steering wheel)

CAUTION

■ **Seat adjustment**

Do not recline the seat more than necessary when the vehicle is in motion, to reduce the risk of sliding under the lap belt. If the seat is too reclined, the lap belt may slide past the hips and apply restraint forces directly to the abdomen or your neck may contact the shoulder belt, increasing the risk of death or serious injury in the event of an accident.

■ **Before folding down a rear seat**

Do not fold down a rear seat when there are passengers sitting in the rear seats or when there is luggage placed on the rear seats.

■ **When returning the seatbacks to their original position**

Observe the following precautions. Failure to do so may result in death or serious injury.

- Be careful not to get your hands pinched in the seat.
- Make sure the seatbacks are securely locked by lightly rocking it back and forth.
- Check that the seat belts are not twisted or caught under the seat.
- Arrange the seat belts in the proper positions for ready use.

NOTICE

■ **When folding down the rear seatbacks**

The seat belts and buckles must be stowed.

1-3. Adjustable components (seats, mirrors, steering wheel) Driving position memory*

Your preferred driving position (the position of the driver's seat and angle of the outside rear view mirrors) can be memorized and recalled by pressing a button. It is also possible to set this function to activate automatically when the doors are unlocked.

Two different driving positions can be entered into memory.

■ Entering a position to memory

STEP 1 Check that the shift lever is in P.

STEP 2 Vehicles with smart key system: Turn the "ENGINE START STOP" switch is in IGNITION ON mode.

Vehicles without smart key system: Turn the engine switch is in the "ON" position.

STEP 3 Adjust the driver's seat and outside rear view mirrors to the desired positions.

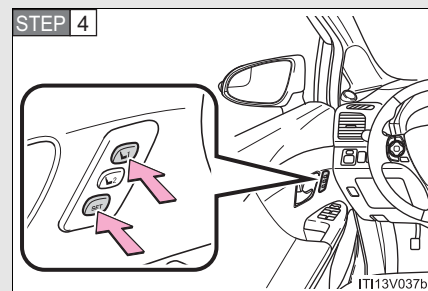

While pressing the "SET" button, or within 3 seconds after the "SET" button is pressed, press button "1" or "2" until the signal beeps.

If the selected button has already been preset, the previously recorded position will be overwritten.

1

Before driving

*: If equipped

1-3. Adjustable components (seats, mirrors, steering wheel)

■ **Recalling the memorized position**

STEP 1 Check that the shift lever is in P.

STEP 2 Vehicles with smart key system: Turn the “ENGINE START STOP” switch is in IGNITION ON mode.

Vehicles without smart key system: Turn the engine switch is in the “ON” position.

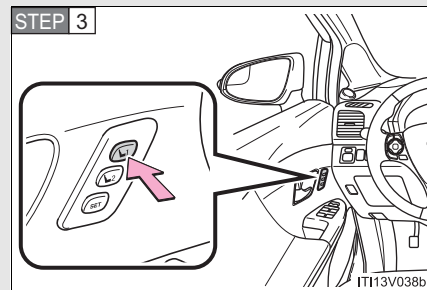

Press button “1” or “2” to recall the desired position.

Power easy access system

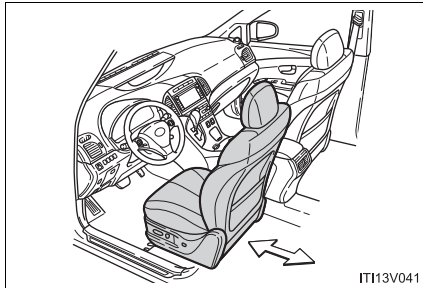

The auto away/return function enables easy access by activating when the driver attempts to enter or exit the vehicle.

1

Before driving

► Auto away function (exiting the vehicle)

When all of the following actions have been performed, the seat will move backward:

- The shift lever has been shifted to “P”.
- Vehicles with smart key system: The “ENGINE START STOP” switch has been turned off.
Vehicles without smart key system: The key is removed from the engine switch.
- The driver’s seat belt has been unfastened.

► Auto return function (entering the vehicle)

When either of the following actions has been performed, the seat will move forward:

- Vehicles with smart key system: The “ENGINE START STOP” switch has been turned to ACCESSORY mode.
Vehicles without smart key system: The engine switch has been turned to the “ACC” position.
- The driver’s seat belt has been fastened.

■ **Operating the driving position memory after turning the “ENGINE START STOP” switch off (vehicles with smart key system) or the key is removed from the engine switch (vehicle without smart key system)**

Memorized seat positions can be activated up to 180 seconds after the driver’s door is opened and another 60 seconds after it is closed again.

■ **Stopping seat position recall operation part-way through**

Perform any of the following operations:

- Press the “SET” button.
- Press button “1” or “2”.
- Adjust the seat using the switches.

■ **Correct seat position**

When the seat is in the most forward or most backward position, and the seat is being moved in those directions, the system may not correctly recognize the current position and the memorized position will not be correctly recalled.

■ **The auto away function for exiting the driver’s seat**

If the seat is already close to the rearmost position, the auto away function may not operate when the driver exits the vehicle.

■ **If the battery is disconnected**

The memorized positions are erased when the battery is disconnected.

■ **Customization**

The auto away function for driver’s seat may be disabled.
(Customizable features: →P. 645)

1-3. Adjustable components (seats, mirrors, steering wheel)

 CAUTION

■ **Seat adjustment caution**

Take care during seat adjustment so that the seat does not strike the rear passenger or squeeze your body against the steering wheel.

1

Before driving

1-3. Adjustable components (seats, mirrors, steering wheel) Head restraints

Head restraints are provided for all seats.

► Front and rear outboard seats

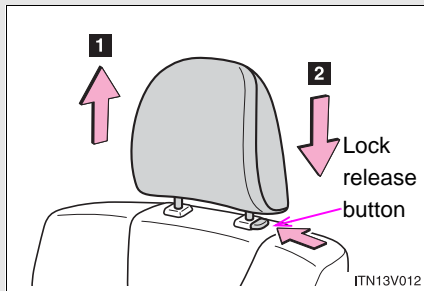

Vertical adjustment

1 Up

Pull the head restraint up.

2 Down

Push the head restraints down while pressing the lock release button.

► Rear center seat (fabric seat)

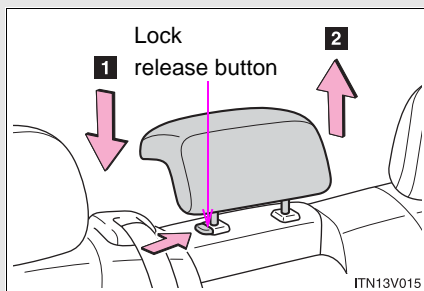

Vertical adjustment

1 Down

Push the head restraint up or down while pressing the lock release button.

2 Up

► Rear center seat (leather seat)

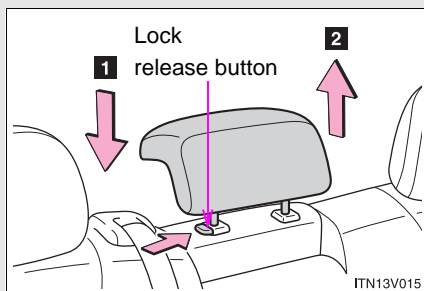

Vertical adjustment

1 Down

Push the head restraint down while pressing the lock release button.

2 Up

Pull the head restraint up.

■ **Adjusting the height of the head restraints**

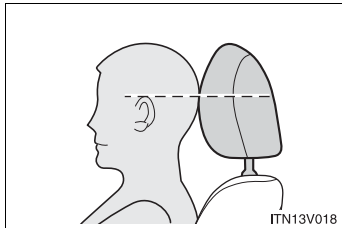

Make sure that the head restraints are adjusted so that the center of the head restraint is closest to the top of your ears.

■ **Adjusting the rear center seat head restraint**

Always raise the head restraint one level from the stowed position when using.

■ **Removing the head restraints**

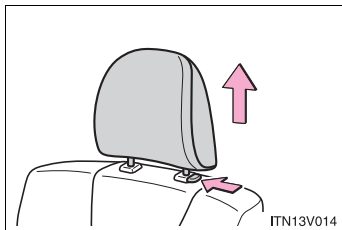

Pull the head restraint up while pressing the lock release button.

■ **Installing the head restraints**

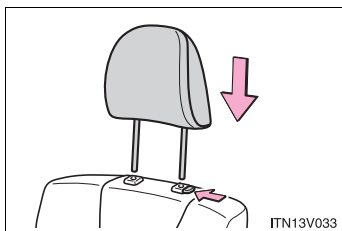

Align the head restraint with the installation holes and push it down to the lock position.

Press and hold the lock release button when lowering the head restraint.

1

Before driving

1-3. Adjustable components (seats, mirrors, steering wheel)

CAUTION

■ Head restraint precautions

Observe the following precautions regarding the head restraints. Failure to do so may result in death or serious injury.

- Use the head restraints designed for each respective seat.
- Adjust the head restraints to the correct position at all times.
- After adjusting the head restraints, push down on them and make sure they are locked in position.
- Do not drive with the head restraints removed.

1-3. Adjustable components (seats, mirrors, steering wheel) Seat belts

Make sure that all occupants are wearing their seat belts before driving the vehicle.

■ Correct use of the seat belts

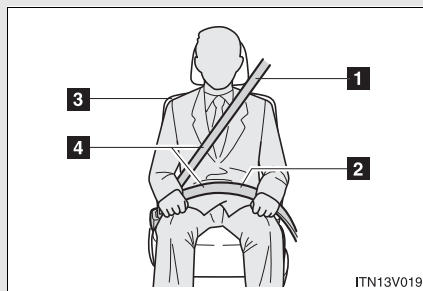

1 Extend the shoulder belt so that it comes fully over the shoulder, but does not come into contact with the neck or slide off the shoulder.

2 Position the lap belt as low as possible over the hips.

3 Adjust the position of the seatback. Sit up straight and well back in the seat.

4 Do not twist the seat belt.

■ Fastening and releasing the seat belt

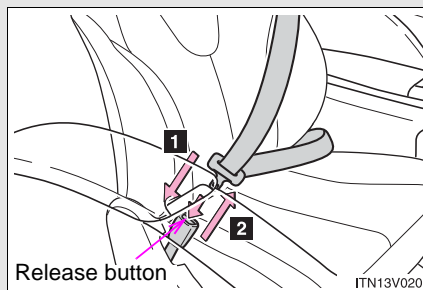

1 Fastening the belt

Push the tab into the buckle until a clicking sound is heard.

2 Releasing the belt

Press the release button.

1
Before driving

1-3. Adjustable components (seats, mirrors, steering wheel)

■ Adjusting the height of the belt (front seats)

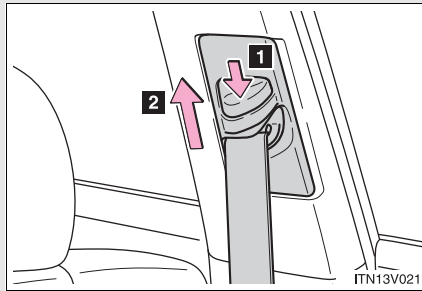

1 Down

2 Up

Move the height adjuster up and down as needed until you hear a click.

Seat belt pretensioners (front seats)

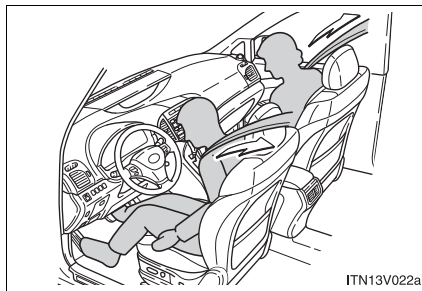

The pretensioner helps the seat belt to quickly restrain the occupant by retracting the seat belt when the vehicle is subjected to certain types of severe frontal or side collision.

The pretensioner does not activate in the event of a minor frontal impact, a minor side impact, a rear impact or a vehicle rollover.

■ **Emergency locking retractor (ELR)**

The retractor will lock the belt during a sudden stop or on impact. It may also lock if you lean forward too quickly. A slow, easy motion will allow the belt to extend, and you can move around fully.

■ **Automatic locking retractor (ALR)**

When a passenger's shoulder belt is completely extended and then retracted even slightly, the belt is locked in that position and cannot be extended. This feature is used to hold the child restraint system (CRS) firmly. To free the belt again, fully retract the belt and then pull the belt out once more. (→P. 146)

■ **When not using the rear outboard seat belts**

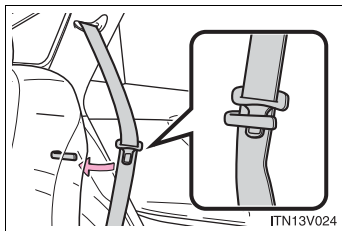

Pass the outer seat belts and plates through the seat belt hangers to prevent the shoulder belts from being damaged.

■ **Child seat belt usage**

The seat belts of your vehicle were principally designed for persons of adult size.

- Use a child restraint system appropriately for the child, until the child becomes large enough to properly wear the vehicle's seat belt. (→P. 140)
- When the child becomes large enough to properly wear the vehicle's seat belt, follow the instructions on P. 81 regarding seat belt usage.

1-3. Adjustable components (seats, mirrors, steering wheel)

■ Replacing the belt after the pretensioner has been activated

If the vehicle is involved in multiple collisions, the pretensioner will activate for the first collision, but will not activate for the second or subsequent collisions.

■ Seat belt extender

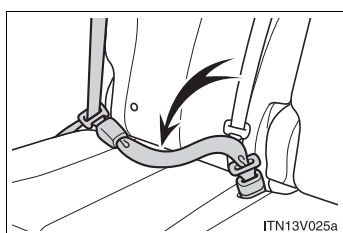

If your seat belts cannot be fastened securely because they are not long enough, a personalized seat belt extender is available from your Toyota dealer free of charge.

⚠ CAUTION

Observe the following precautions to reduce the risk of injury in the event of sudden braking, sudden swerving or an accident. Failing to do so may cause death or serious injury.

■ Wearing a seat belt

- Ensure that all passengers wear a seat belt.
- Always wear a seat belt properly.
- Each seat belt should be used by one person only. Do not use a seat belt for more than one person at the same time, including children.
- Toyota recommends that children should be seated in the rear seat and always use a seat belt and/or an appropriate child restraint system.
- Do not recline the seat any more than necessary to achieve a proper seating position. The seat belt is most effective when the occupants are sitting up straight and well back in the seats.
- Do not wear the shoulder belt under your arm.
- Always wear your seat belt low and snug across your hips.

⚠ CAUTION

■ Pregnant women

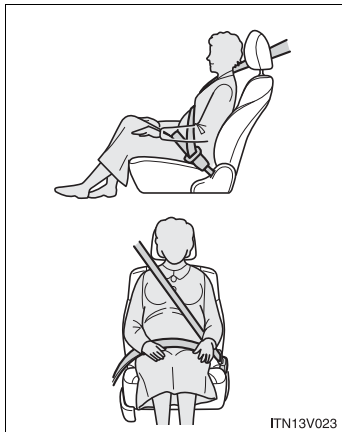

Obtain medical advice and wear the seat belt in the proper way. (→P. 81)

Women who are pregnant should position the lap belt as low as possible over the hips in the same manner as other occupants. Extend the shoulder belt completely over the shoulder and position the belt across the chest. Avoid belt contact over the rounding of the abdominal area.

If the seat belt is not worn properly, not only the pregnant woman, but also the fetus could suffer death or serious injury as a result of sudden braking or a collision.

■ People suffering illness

Obtain medical advice and wear the seat belt in the proper way. (→P. 81)

■ When children are in the vehicle

Do not allow children to play with the seat belt. If the belt becomes twisted around a child's neck, it may lead to choking or other serious injuries that could result in death.

If this occurs and the buckle cannot be unfastened, scissors should be used to cut the belt.

■ Adjustable shoulder anchor

Always make sure the shoulder belt is positioned across the center of your shoulder. The belt should be kept away from your neck, but not falling off your shoulder. Failure to do so could reduce the amount of protection in an accident and cause death or serious injuries in the event of a sudden stop, sudden swerve or an accident. (→P. 82)

 CAUTION

■ **Seat belt pretensioners**

- Do not place anything, such as a cushion, on the front passenger's seat. Doing so will disperse the passenger's weight, which prevents the sensor from detecting the passenger's weight properly. As a result, the seat belt pretensioner for the front passenger's seat may not activate in the event of a collision.
- If the pretensioner has activated, the SRS warning light will come on. In that case, the seat belt cannot be used again and must be replaced at your Toyota dealer.

■ **Seat belt damage and wear**

- Do not damage the seat belts by allowing the belt, plate or buckle to be jammed in the door.
- Inspect the seat belt system periodically. Check for cuts, fraying, and loose parts. Do not use a damaged seat belt until it is replaced. Damaged seat belts cannot protect an occupant from death or serious injury.
- Ensure that the belt and tab are locked and the belt is not twisted. If the seat belt does not function correctly, immediately contact your Toyota dealer.
- Replace the seat assembly, including the belts, if your vehicle has been involved in a serious accident, even if there is no obvious damage.
- Do not attempt to install, remove, modify, disassemble or dispose of a seat belt. Have any necessary repairs carried out by your Toyota dealer. Inappropriate handling of the pretensioner may cause it to activate or operate improperly and may cause death or serious injury.

 CAUTION

■ **Using a seat belt extender**

- Do not wear the seat belt extender, if you can fasten the seat belt without the extender.
- Do not use the seat belt extender when installing a child restraint system, because the belt will not securely hold the child restraint system, increasing the risk of death or serious injury in the event of a sudden stop, sudden swerve or an accident.
- The personalized extender may not be safe on another vehicle, when used by another person, or at a different seating position other than the one originally intended.

 NOTICE

■ **When using a seat belt extender**

When releasing the seat belt, press on the buckle release button on the extender, not on the seat belt.
This helps prevent damage to the vehicle interior and the extender itself.

1

Before driving

1-3. Adjustable components (seats, mirrors, steering wheel) Steering wheel

The steering wheel can be adjusted to a comfortable position.

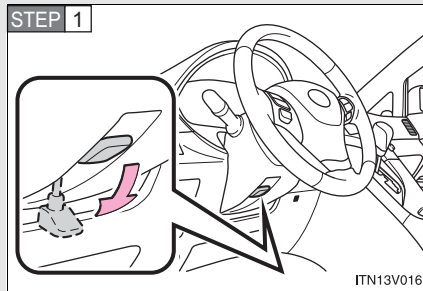

Hold the steering wheel and press the lever down.

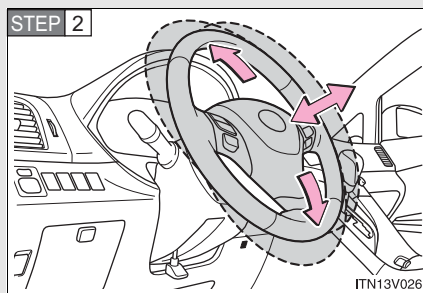

Adjust to the ideal position by moving the steering wheel horizontally and vertically.

After adjustment, pull the lever up to secure the steering wheel.

⚠ CAUTION

■ While driving

Do not adjust the steering wheel.
Doing so may cause the driver to mishandle the vehicle and an accident, resulting in death or serious injury.

■ After adjusting the steering wheel

Make sure that the steering wheel is securely locked.
Otherwise, the steering wheel may move suddenly, possibly causing an accident and resulting in death or serious injury.

1-3. Adjustable components (seats, mirrors, steering wheel) Inside rear view mirror

The rear view mirror's position can be adjusted to enable sufficient confirmation of the rear view in accordance with the driver's seating posture.

Adjusting the height of rear view mirror

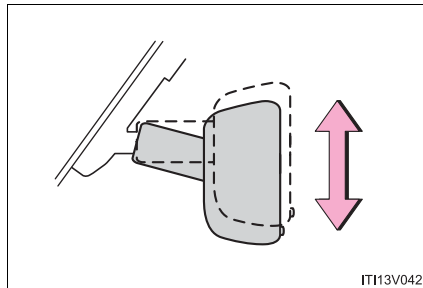

Adjust the height of the rear view mirror by moving it up and down.

1

Before driving

Automatic anti-glare function

Responding to the level of brightness of the headlights of vehicles behind, the reflected light is automatically reduced.

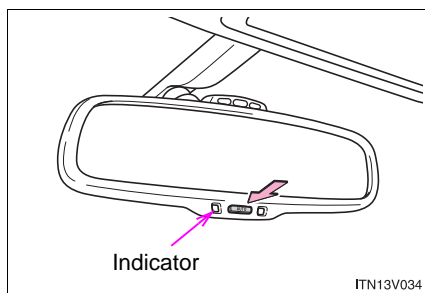

Changing automatic anti-glare function mode ON/OFF

When the automatic anti-glare function is in ON mode, the indicator illuminates.

► Vehicles with smart key system

The function will set to ON mode each time the "ENGINE START STOP" switch is turned to IGNITION ON mode.

Pressing the button turns the function to OFF mode. (The indicator also turns off.)

► Vehicles without smart key system

The function will set to ON mode each time the engine switch is turned to the "ON" position.

Pressing the button turns the function to OFF mode. (The indicator also turns off.)

1-3. Adjustable components (seats, mirrors, steering wheel)

■ To prevent sensor error

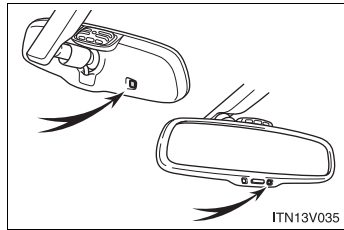

To ensure correct functioning of the sensors, do not touch or cover the sensors.

1

Before driving

⚠ CAUTION

■ While driving

Do not adjust the position of the mirror.
Doing so may lead to mishandling of the vehicle and an accident, or resulting in death or serious injury.

1-3. Adjustable components (seats, mirrors, steering wheel) Outside rear view mirrors

Mirror angle can be adjusted using the switch.

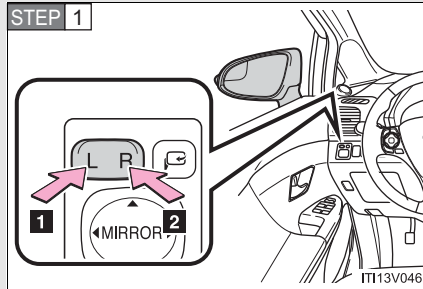

Select a mirror to adjust.

- 1 Left
- 2 Right

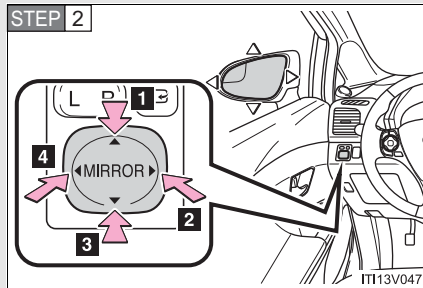

Adjust the mirror.

- 1 Up
- 2 Right
- 3 Down
- 4 Left

Folding back the mirrors (power type)

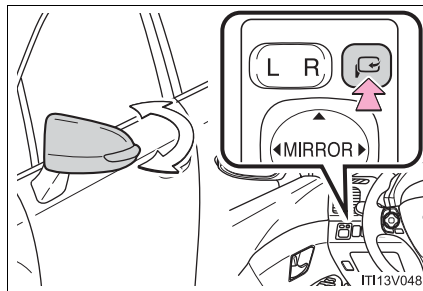

Press the switch to fold the mirrors.

Press it again to extend them to the original position.

1-3. Adjustable components (seats, mirrors, steering wheel)

Folding back the mirrors (manual type)

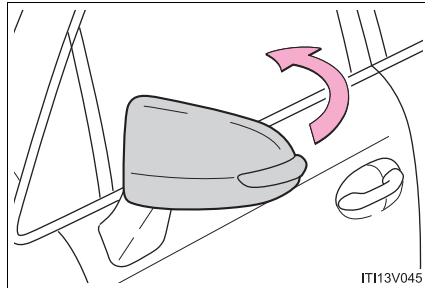

Push backward to fold the mirrors.

1

Before driving

Blind Spot Mirrors

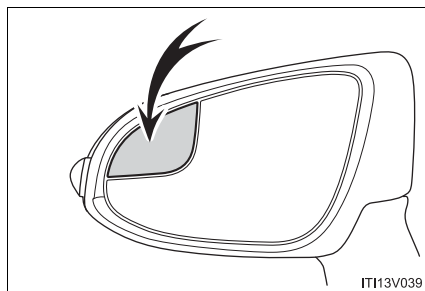

The Blind Spot Mirrors increase the view of surrounding area to assist the driver when checking surrounding area before changing lanes.

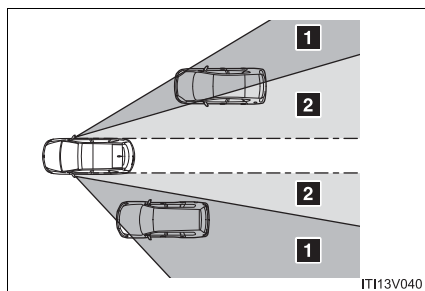

- 1** Blind Spot Mirror field of view
- 2** Main mirror field of view

Linked mirror function when reversing (if equipped)

When the mirror select switch is in the L or R position, the outside rear view mirrors will automatically angle downwards when the vehicle is reversing in order to give a better view of the ground.

To disable this function, move the mirror select switch to the neutral position (between L and R).

■ Adjusting the mirror angle when the vehicle is reversing

With the shift lever in R, adjust the mirror angle at a desired position.

The adjusted angle will be memorized and the mirror will automatically tilt to the memorized angle whenever the shift lever is shifted to R from next time.

The memorized downward tilt position of the mirror is linked to the normal position (angle adjusted when the shift lever in other than R). Therefore, if the normal position is changed after adjustment, the tilt position will also change.

When the normal position is changed, readjust the angle in reversing.

■ Mirror angle can be adjusted when

▶ Vehicles with smart key system

The "ENGINE START STOP" switch is in ACCESSORY or IGNITION ON mode.

▶ Vehicles without smart key system

The engine switch is in the "ACC" or "ON" position.

■ When the mirrors are fogged up

The outside rear view mirrors can be cleared using the mirror defoggers. Turn on the rear window defogger to turn on the outside rear view mirror defoggers. (→P. 316)

■ Automatic adjustment of the mirror angle (if equipped)

The mirror adjustment can be entered into memory and recalled automatically by the driving position memory. (→P. 73)

 CAUTION

■ **While driving**

Observe the following precautions.

Failing to do so may result in losing control of the vehicle and cause an accident, resulting in death or serious injury.

- Do not adjust the mirrors.
- Do not drive with the mirrors folded back.
- Before driving, be sure to extend mirrors and make an adjustment properly.

■ **When a mirror is moving**

To avoid personal injury and mirror malfunction, be careful not to get your hand caught by the moving mirror.

■ **When the mirror defoggers are operating**

Do not touch the rear view mirror surfaces, as they can become very hot and burn you.

 NOTICE

■ **If ice should jam the mirror**

Do not operate the control or scrape the mirror face. Use a spray de-icer to free the mirror.

1

Before driving

1-4. Opening and closing the windows and moon roof Power windows

The power windows can be opened and closed using the following switches.

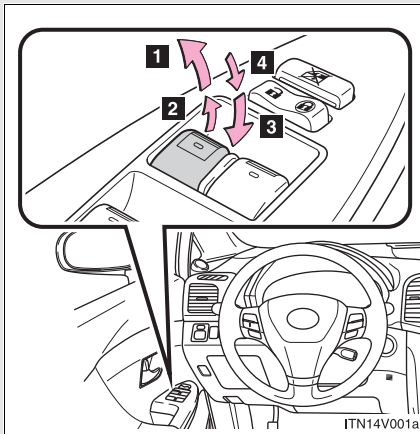

- 1** One-touch closing*
- 2** Closing
- 3** One-touch opening*
- 4** Opening

*: To stop the window partway, operate the switch in the opposite direction.

Window lock switch

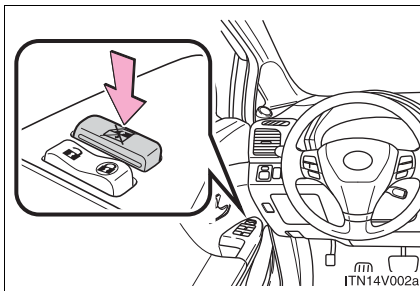

Press the switch down to lock passenger window switches.

Use this switch to prevent children from accidentally opening or closing a passenger window.

■ **The power windows can be operated when**

- ▶ Vehicles with smart key system

The “ENGINE START STOP” switch is in IGNITION ON mode.

- ▶ Vehicles without smart key system

The engine switch is in the “ON” position.

■ **Operating the power windows after turning the engine off**

- ▶ Vehicles with smart key system

The power windows can be operated for approximately 45 seconds even after the “ENGINE START STOP” switch is turned to ACCESSORY mode or turned off. They cannot, however, be operated once either front door is opened.

- ▶ Vehicles without smart key system

The power windows can be operated for approximately 45 seconds even after the engine switch is turned to the “ACC” or “LOCK” position. They cannot, however, be operated once either front door is opened.

■ **Jam protection function**

If an object becomes caught between the window and the window frame, window travel is stopped and the window is opened slightly.

1-4. Opening and closing the windows and moon roof

■ When the power window does not close normally

If the jam protection function is operating abnormally and a window cannot be closed, perform the following operations using the power window switch on the relevant door.

- After stopping the vehicle, the window can be closed by holding the power window switch in the one-touch closing position while the “ENGINE START STOP” switch is turned to IGNITION ON mode (vehicles with smart key system) or the engine switch is turned to the “ON” position (vehicles without smart key system).
- If the window still cannot be closed even by carrying out the operation explained above, initialize the function by performing the following procedure.

STEP 1 Hold the power window switch in the one-touch closing position. Continue holding the switch for a further 6 seconds after the window has closed.

STEP 2 Hold the power window switch in the one-touch opening position. Continue holding the switch for a further 2 seconds after the window has opened completely.

STEP 3 Hold the power window switch in the one-touch closing position once again. Continue holding the switch for a further 2 seconds after the window has closed.

If you release the switch while the window is moving, start again from the beginning. If the window continues to close but then re-open slightly even after performing the above procedure correctly, have the vehicle inspected by your Toyota dealer.

■ Customization

Settings (e.g. Rear window Auto Up/Down) can be changed.
(Customizable features →P. 645)

 CAUTION

■ **Closing the windows**

Observe the following precautions.
Failing to do so may result in death or serious injury.

- The driver is responsible for all the power window operations, including the operation for the passengers. In order to prevent accidental operation, especially by a child, do not let a child operate the power windows. It is possible for children and other passengers to have body parts caught in the power window. Also, when riding with a child, it is recommended to use the window lock switch. (→P. 96)

- Check to make sure that all passengers do not have any part of their body in a position where it could be caught when a window is being operated.

- Vehicles with smart key system:

When exiting the vehicle, turn the “ENGINE START STOP” switch off, carry the key and exit the vehicle along with the child. There may be accidental operation, due to mischief, etc., that may possibly lead to an accident.

Vehicles without smart key system:

When exiting the vehicle, turn the engine switch to the “LOCK” position, carry the key and exit the vehicle along with the child. There may be accidental operation, due to mischief, etc., that may possibly lead to an accident.

■ **Jam protection function**

- Never try jamming any part of your body to activate the jam protection function intentionally.

- The jam protection function may not work if something gets caught just before the window fully closes.

1-4. Opening and closing the windows and moon roof Moon roof*

Use the overhead switches to open, close, and tilt the moon roof up and down.

■ Opening and closing

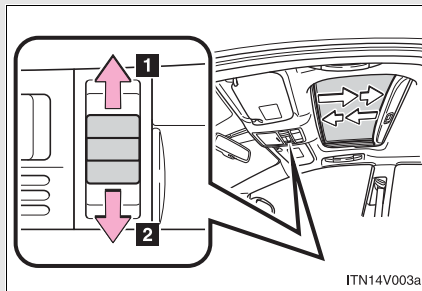

1 Open

The moon roof stops slightly before the fully open position to reduce wind noise. Move the switch backward again to fully open.

2 Close (push and hold)

The moon roof stops once. Push and hold the switch again to fully close.

■ Tilt up and down

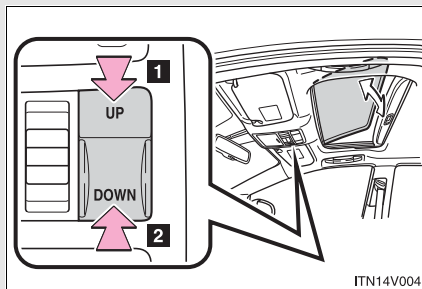

1 Tilt up

2 Tilt down (push and hold)

*: If equipped

■ **The moon roof can be operated when**

- ▶ Vehicles with smart key system

The “ENGINE START STOP” switch is in IGNITION ON mode.

- ▶ Vehicles without smart key system

The engine switch is in the “ON” position.

■ **Operating the moon roof after turning the engine off**

- ▶ Vehicles with smart key system

The moon roof can be operated for approximately 45 seconds even after the “ENGINE START STOP” switch is turned to ACCESSORY mode or turned off. It cannot, however, be operated once either front door is opened.

- ▶ Vehicles without smart key system

The moon roof can be operated for approximately 45 seconds even after the engine switch is turned to the “ACC” or “LOCK” position. It cannot, however, be operated once either front door is opened.

■ **To reduce moon roof wind noise**

When the moon roof is opened automatically, it will stop slightly before the fully open position. Driving with the moon roof in this position can help reduce wind noise.

■ **Sunshade**

→P. 104

■ **Open moon roof warning buzzer**

- ▶ Vehicles with smart key system

The buzzer sounds and message is shown on the multi-information display (TFT type only) when the “ENGINE START STOP” switch is turned off and the driver’s door is opened with the moon roof open.

- ▶ Vehicles without smart key system

The buzzer sounds and message is shown on the multi-information display (TFT type only) when the engine switch is turned to the “LOCK” position and the driver’s door is opened with the moon roof open.

1-4. Opening and closing the windows and moon roof

■ When the moon roof does not close normally

Perform the following procedure:

STEP 1 Stop the vehicle.

STEP 2 Open the moon roof halfway.

STEP 3 Press and hold the open/close switch in the close position.
When the moon roof reaches the full close position, maintain the open/close switch in the close position for more than 2 seconds.
It will adjust slightly and then stop.

STEP 4 To ensure the initialization is complete, make sure opening, closing, tilting up and down functions work properly.

If the moon roof does not fully close even after performing the above procedure correctly, have the vehicle inspected by your Toyota dealer.

 CAUTION

■ **Opening the moon roof**

Observe the following precautions.

Failing to do so may cause death or serious injury.

- Do not allow any passengers to put their hands or heads outside the vehicle while it is moving.
- Do not sit on top of the moon roof.

■ **Closing the moon roof**

Observe the following precautions.

Failing to do so may result in death or serious injury.

- The driver is responsible for moon roof opening and closing operations. In order to prevent accidental operation, especially by a child, do not let a child operate the moon roof. It is possible for children and other passengers to have body parts caught in the moon roof.
- Check to make sure that all passengers do not have any part of their bodies in a position where they could be caught when the moon roof is being operated.
- Vehicles with smart key system:
When exiting the vehicle, turn the “ENGINE START STOP” switch off, carry the key and exit the vehicle along with the child. There may be accidental operation, due to mischief, etc., that may possibly lead to an accident.
Vehicles without smart key system:
When exiting the vehicle, turn the engine switch to the “LOCK” position, carry the key and exit the vehicle along with the child. There may be accidental operation, due to mischief, etc., that may possibly lead to an accident.

1-4. Opening and closing the windows and moon roof Sunshade*

The sunshade can be opened and closed manually.

► Front

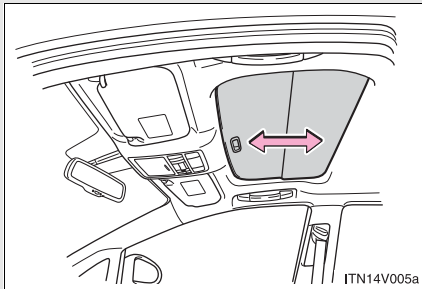

Slide the sunshade.

The front sunshade will open automatically when the moon roof is opened. (→P. 100)

► Rear

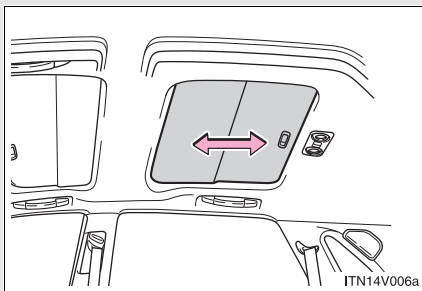

Slide the sunshade.

*: If equipped

1-5. Refueling Opening the fuel tank cap

Perform the following steps to open the fuel tank cap.

■ Before refueling the vehicle

- Vehicles with smart key system

Turn the “ENGINE START STOP” switch off and ensure that all the doors and windows are closed.

- Vehicles without smart key system

Turn the engine switch to the “LOCK” position and ensure that all the doors and windows are closed.

- Confirm the type of fuel. (→P. 106)

■ Opening the fuel tank cap

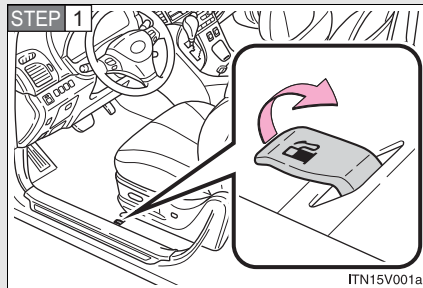

Pull the lever.

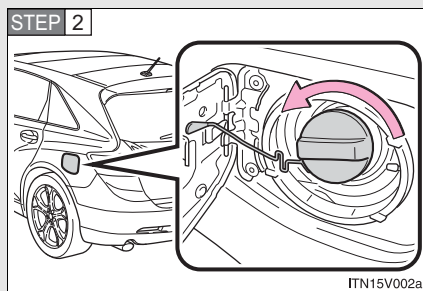

Turn the fuel tank cap slowly to open.

1

Before driving

1-5. Refueling

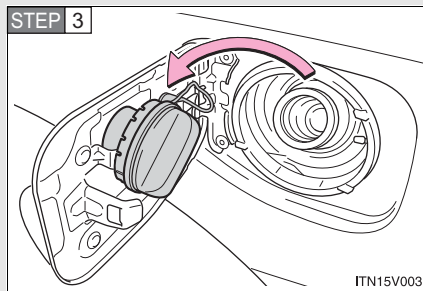

Hang the fuel tank cap on the back of the fuel filler door.

Closing the fuel tank cap

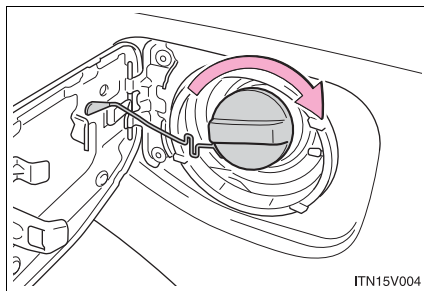

When replacing the fuel tank cap, turn it until a clicking sound is heard.

After releasing your hand, the cap will turn slightly to the opposite direction.

■ Fuel types

Unleaded gasoline (Octane rating 87 [Research Octane Number 91] or higher)

⚠ CAUTION**■ Refueling the vehicle**

Observe the following precautions while refueling the vehicle.
Failure to do so, may result in death or serious injury.

- Touch the vehicle or some other metal surface to discharge any static electricity.
Sparks resulting from discharging static electricity may cause the fuel vapors to ignite.
- Always hold the grips on the fuel tank cap and turn it slowly to remove it.
A whooshing sound may be heard when the fuel tank cap is loosened.
Wait until the sound cannot be heard before fully removing the cap.
In hot weather, pressurized fuel may spray out the filler neck and cause injury.
- Do not allow anyone that has not discharged static electricity from their bodies to come close to an open fuel tank.
- Do not inhale vaporized fuel.
Fuel contains substances that are harmful if inhaled.
- Do not smoke while refueling the vehicle.
Doing so may cause the fuel to ignite and cause a fire.
- Do not return to the vehicle or touch any person or object that is statically charged.
This may cause static electricity to build up, resulting in a possible ignition hazard.

1

Before driving

 CAUTION

■ **When refueling**

Observe the following precautions to prevent fuel overflowing from the fuel tank:

- Securely insert the fuel nozzle into the fuel filler neck
- Stop filling the tank after the fuel nozzle automatically clicks off
- Do not top off the fuel tank

■ **When replacing the fuel tank cap**

Do not use anything but a genuine Toyota fuel tank cap designed for your vehicle. Doing so may cause a fire or other incident which may result in death or serious injury.

 NOTICE

■ **Refueling**

Do not spill fuel during refueling.
Doing so may damage the vehicle, such as causing the exhaust systems to operate abnormally or damaging fuel system components or the vehicle's painted surface.

1-6. Theft deterrent system Engine immobilizer system

The vehicle's keys have built-in transponder chips that prevent the engine from starting if a key has not been previously registered in the vehicle's on-board computer.

Never leave the keys inside the vehicle when you leave the vehicle.

This system is designed to help prevent vehicle theft but does not guarantee absolute security against all vehicle thefts.

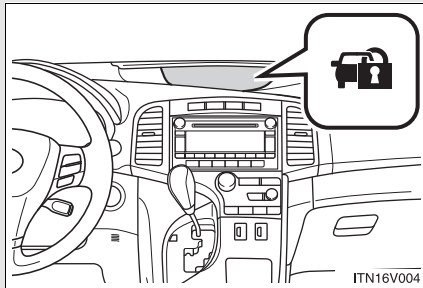

Vehicles with smart key system:

The indicator light flashes after the "ENGINE START STOP" switch has been turned off to indicate that the system is operating.

The indicator light stops flashing after the "ENGINE START STOP" switch has been turned to ACCESSORY or IGNITION ON mode to indicate that the system has been canceled.

1

Before driving

1-6. Theft deterrent system

Vehicles without smart key system:

The indicator light flashes after the key has been removed from the engine switch to indicate that the system is operating.

The indicator light stops flashing after the registered key has been inserted into the engine switch to indicate that the system has been canceled.

■ System maintenance

The vehicle has a maintenance-free type engine immobilizer system.

■ Conditions that may cause the system to malfunction

- If the key is in contact with a metallic object.
- If the key is in close proximity to or touching a key to the security system (key with a built-in transponder chip) of another vehicle.

■ Certifications for the engine immobilizer system

- For vehicles sold in the U.S.A.
 - ▶ Vehicles with smart key system
FCC ID: NI4TMIMB-1
 - ▶ Vehicles without smart key system
FCC ID: MOZRI-21BTY

NOTE:

This device complies with Part 15 of the FCC Rules. Operation is subject to the following two conditions: (1) this device may not cause harmful interference, and (2) this device must accept any interference received, including interference that may cause undesired operation.

FCC WARNING:

Changes or modifications not expressly approved by the party responsible for compliance could void the user's authority to operate the equipment.

- For vehicles sold in Canada

Operation is subject to the following two conditions: (1) this device may not cause interference, and (2) this device must accept any interference, including interference that may cause undesired operation of the device.

 NOTICE

■ **To ensure the system operates correctly**

Do not modify or remove the system. If modified or removed, the proper operation of the system cannot be guaranteed.

1

Before driving

1-6. Theft deterrent system Alarm*

The system sounds the alarm and flashes lights when forcible entry is detected.

■ Triggering of the alarm

The alarm is triggered in the following situations when the alarm is set.

- A locked door is unlocked or opened in any way other than by using the entry function (vehicles with smart key system), the wireless remote control door lock function or the mechanical key. (The doors will lock again automatically.)
- The hood is opened.
- The battery is reconnected.
- The side windows are tapped or broken.

■ Setting the alarm system

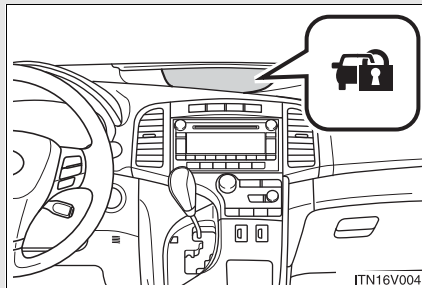

Close the doors and hood, and lock all doors using the entry function (vehicles with smart key system) or the wireless remote control. The system will be set automatically after 30 seconds.

The indicator light changes from being on to flashing when the system is set.

*: If equipped

■ **Deactivating or stopping the alarm**

Do one of the following to deactivate or stop the alarm.

- Unlock the doors using the entry function (vehicles with smart key system) or the wireless remote control.
- Start the engine. (The alarm will be deactivated or stopped after a few seconds.)

1

Before driving

■ **System maintenance**

The vehicle has a maintenance-free type alarm system.

■ **Items to check before locking the vehicle**

To prevent unexpected triggering of the alarm and vehicle theft, make sure of the following.

- Nobody is in the vehicle.
- The windows and moon roof are closed before the alarm is set.
- No valuables or other personal items are left in the vehicle.

1-6. Theft deterrent system

■ Triggering of the alarm

The alarm may be triggered in the following situations.
(Stopping the alarm deactivates the alarm system.)

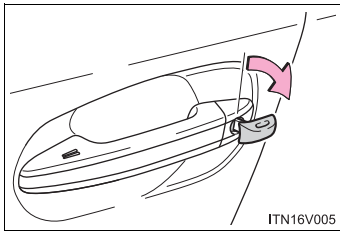

- The doors are unlocked using the mechanical key.

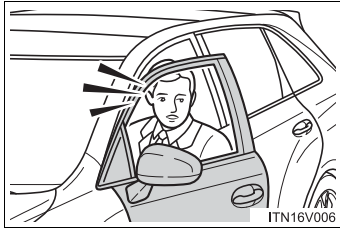

- A person inside the vehicle opens a door or hood.

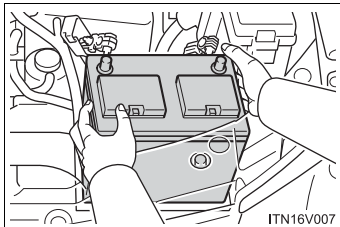

- The battery is recharged or replaced when the vehicle is locked.

■ **Panic mode**

▶ Vehicles with smart key system

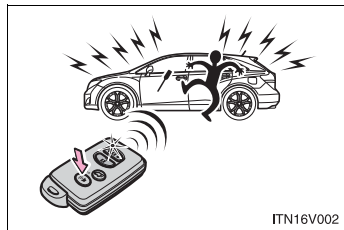

When  is pressed for longer than about one second, an alarm will sound for about 60 seconds and the vehicle lights will flash or come on to deter any person from trying to break into or damage your vehicle.

To stop the alarm, press any button on the wireless remote control.

1

Before driving

▶ Vehicles without smart key system

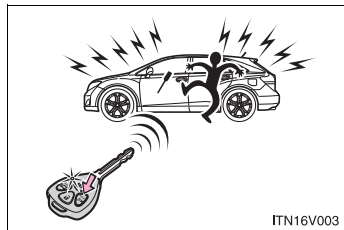

■ **Customization**

Settings (e.g. time elapsed before the alarm is set) can be changed.
(Customizable features →P. 645)

 **NOTICE**

■ **To ensure the system operates correctly**

Do not modify or remove the system. If modified or removed, the proper operation of the system cannot be guaranteed.

1-6. Theft deterrent system

Theft prevention labels (U.S.A.)

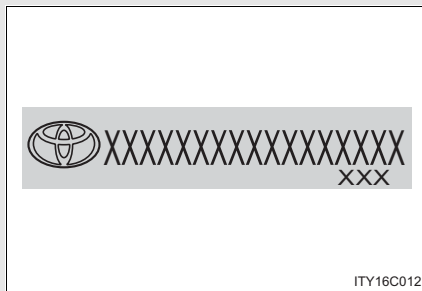

These labels are attached to the vehicle to reduce vehicle theft by facilitating the tracing and recovery of parts from stolen vehicles. Do not remove under penalty of law.

1-7. Safety information

Correct driving posture

Drive with a good posture as follows:

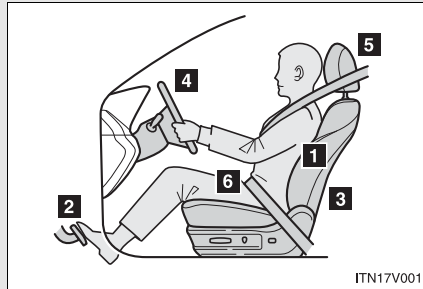

- 1** Sit upright and well back in the seat.
- 2** Adjust the position of the seat forward or backward to ensure the pedals can be reached and easily depressed to the extent required. (→P. 67)
- 3** Adjust the seatback so that the controls are easily operable.
- 4** Adjust the tilt and telescopic positions of the steering wheel downward so the air-bag is facing your chest. (→P. 88)
- 5** Lock the head restraint in place with the center of the head restraint closest to the top of your ears. (→P. 78)
- 6** Wear the seat belt correctly. (→P. 81)

1
Before driving

 CAUTION

■ **While driving**

- Do not adjust the position of the driver's seat.
Doing so could cause the driver to lose control of the vehicle.
- Do not place a cushion between the driver or passenger and the seatback.
A cushion may prevent correct posture from being achieved, and reduce the effectiveness of the seat belt and head restraint, increasing the risk of death or serious injury to the driver or passenger.
- Do not place anything under the front seats.
Objects placed under the front seats may become jammed in the seat tracks and stop the seat from locking in place. This may lead to an accident. The adjustment mechanism may also be damaged.

■ **Adjusting the seat position**

- Do not recline the seat more than necessary when the vehicle is in motion, to reduce the risk of sliding under the lap belt.
If the seat is too reclined during an accident, the lap belt may slide past the hips and apply restraint forces directly to the abdomen or your neck may contact the shoulder belt, increasing the risk of death or serious injury.
- Take care when adjusting the seat position to ensure that other passengers are not injured by the moving seat.
- Do not put your hands under the seat or near the moving parts to avoid injury.
Fingers or hands may become jammed in the seat mechanism.

1-7. Safety information SRS airbags

The SRS airbags inflate when the vehicle is subjected to certain types of severe impacts that may cause significant injury to the occupants. They work together with the seat belts to help reduce the risk of death or serious injury.

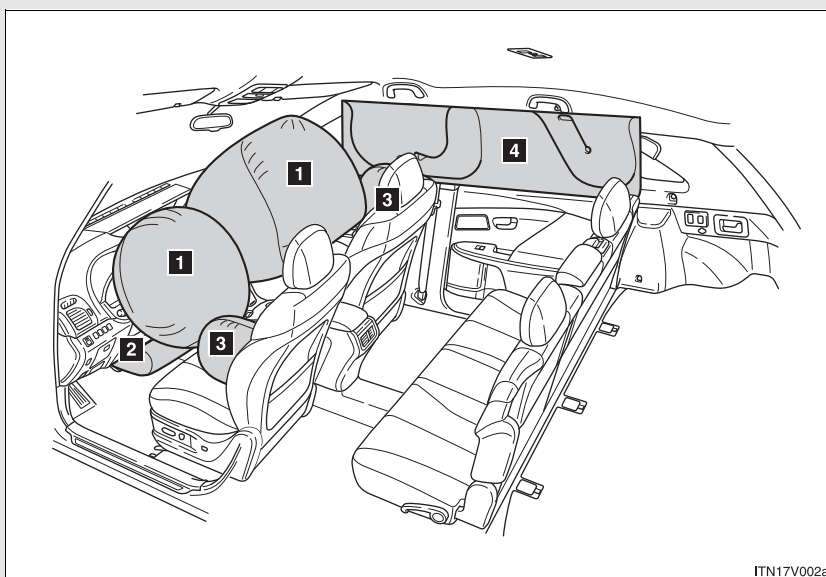

ITN17V002a

► Front airbags

1 Driver airbag/front passenger airbag

Can help protect the head and chest of the driver and front passenger from impact with interior components.

2 Knee airbag

Can help provide driver protection.

1

Before driving

1-7. Safety information

▶ Side and curtain shield airbags

3 Side airbags

Can help protect the torso of the front seat occupants.

4 Curtain shield airbags

Can help protect primarily the head of front and rear outboard seat occupants.

Airbag system components

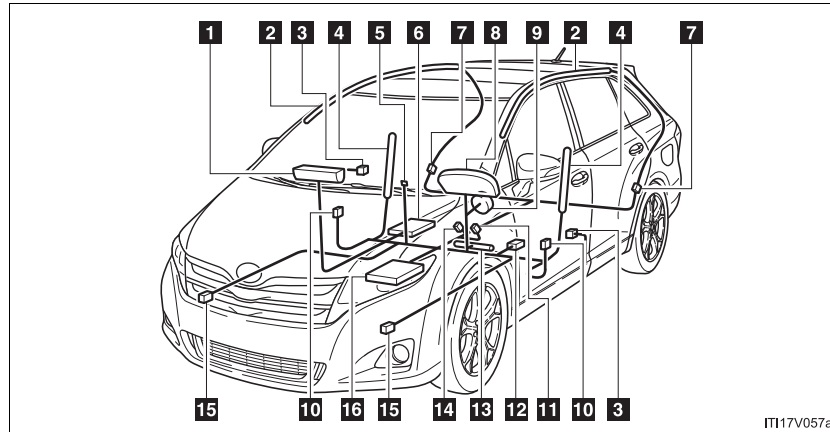

- | | |
|---|---|
| 1 Front passenger airbag | 9 Driver airbag |
| 2 Curtain shield airbag | 10 Side impact sensors (front door) |
| 3 Seat belt pretensioners and force limiters | 11 Driver's seat belt buckle switch |
| 4 Side airbag | 12 Driver's seat position sensor |
| 5 "AIR BAG ON/OFF" indicator light | 13 Knee airbag |
| 6 Front passenger occupant classification system (ECU and sensors) | 14 Front passenger's seat belt buckle switch |
| 7 Side impact sensors (rear) | 15 Front impact sensors |
| 8 SRS warning light | 16 Airbag sensor assembly |

1

Before driving

1-7. Safety information

Your vehicle is equipped with “ADVANCED AIRBAGS” designed based on the US motor vehicle safety standards (FMVSS208). The airbag sensor assembly (ECU) controls airbag deployment based on information obtained from the sensors etc. shown in the system components diagram above. This information includes crash severity and occupant information. As the airbags deploy, a chemical reaction in the inflators quickly fills the airbags with non-toxic gas to help restrain the motion of the occupants.

■ If the SRS airbags deploy (inflate)

- Bruising and slight abrasions may result from contact with a deploying (inflating) SRS airbag.
- A loud noise and white powder will be emitted.
- Parts of the airbag module (steering wheel hub, airbag cover and inflator) as well as the front seats and parts of the front and rear pillars, and roof side rail, may be hot for several minutes. The airbag itself may also be hot.
- The windshield may crack.

■ SRS airbag deployment conditions (front airbags)

- The SRS front airbags will deploy in the event of an impact that exceeds the set threshold level (the level of force corresponding to an approximately 12 - 18 mph [20 - 30 km/h] frontal collision with a fixed wall that does not move or deform).

However, this threshold velocity will be considerably higher in the following situations:

- If the vehicle strikes an object, such as a parked vehicle or sign pole, which can move or deform on impact
- If the vehicle is involved in an underride collision, such as a collision in which the front of the vehicle “underrides”, or goes under, the bed of a truck
- Depending on the type of collision, it is possible that only the seat belt pretensioners will activate.
- The SRS front airbags for the front passenger will not activate if there is no passenger sitting in the front passenger seat. However, the SRS front airbags for the front passenger may deploy if luggage is put in the seat, even if the seat is unoccupied. (→P. 134)

■ SRS airbag deployment conditions (side and curtain shield airbags)

- The SRS side and curtain shield airbags will deploy in the event of an impact that exceeds the set threshold level (the level of force corresponding to the impact force produced by an approximately 3300 lb. [1500 kg] vehicle colliding with the vehicle cabin from a direction perpendicular to the vehicle orientation at an approximate speed of 12 - 18 mph [20 - 30 km/h]).
- The SRS curtain shield airbags may also deploy in the event of a severe frontal collision.

1

Before driving

■ **Conditions under which the SRS airbags may deploy (inflate), other than a collision**

The SRS front airbags may also deploy if a serious impact occurs to the underside of your vehicle. Some examples are shown in the illustration.

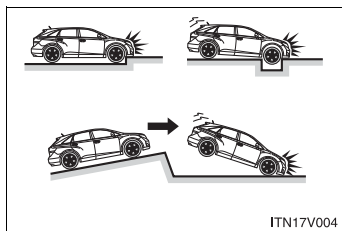

- Hitting a curb, edge of pavement or hard surface
- Falling into or jumping over a deep hole
- Landing hard or vehicle falling

■ **Types of collisions that may not deploy the SRS airbag (front airbags)**

The SRS front airbags are generally not designed to inflate if the vehicle is involved in a side or rear collision, if it rolls over, or if it is involved in a low-speed frontal collision. But, whenever a collision of any type causes sufficient forward deceleration of the vehicle, deployment of the SRS front airbags may occur.

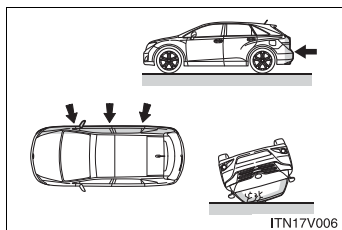

- Collision from the side
- Collision from the rear
- Vehicle rollover

■ **Types of collisions that may not deploy the SRS airbag (side airbags and curtain shield airbags)**

The SRS side airbag and curtain shield airbag system may not activate if the vehicle is subjected to a collision from the side at certain angles, or a collision to the side of the vehicle body other than the passenger compartment.

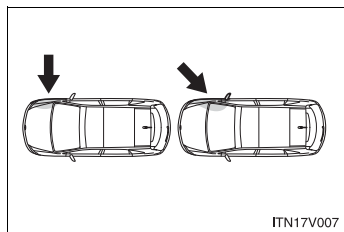

- Collision from the side to the vehicle body other than the passenger compartment
- Collision from the side at an angle

The SRS side airbags and curtain shield airbags are not generally designed to inflate if the vehicle is involved in a frontal or rear collision, if it rolls over, or if it is involved in a low-speed side collision.

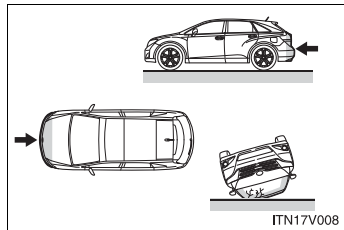

- Collision from the front*
- Collision from the rear
- Vehicle rollover

*: Depending on the conditions and type of accident, the curtain shield airbags may deploy (inflate) upon frontal impact.

1

Before driving

1-7. Safety information

■ When to contact your Toyota dealer

In the following cases, the vehicle will require inspection and/or repair. Contact your Toyota dealer as soon as possible.

- Any of the SRS airbags have been inflated.

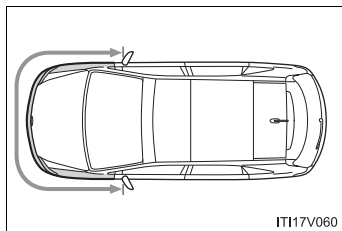

- The front of the vehicle is damaged or deformed, or the vehicle was involved in an accident that was not severe enough to cause the SRS airbags to inflate.

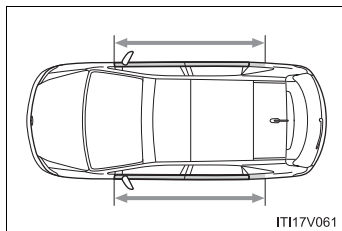

- A portion of the doors is damaged or deformed, or the vehicle was involved in an accident that was not severe enough to cause the SRS side airbags and curtain shield airbags to inflate.

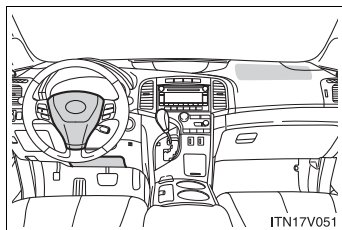

- The pad section of the steering wheel, dashboard near the front passenger airbag or lower portion of the instrument panel is scratched, cracked or otherwise damaged.

1-7. Safety information

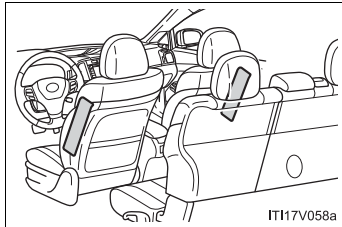

- The surface of the seats with the side airbag is scratched, cracked, or otherwise damaged.

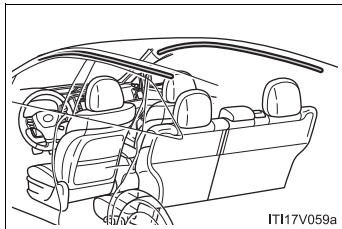

- The portion of the front, center and rear pillars or roof side rail garnishes (padding) containing the curtain shield airbags inside is scratched, cracked or otherwise damaged.

1

Before driving

 CAUTION

■ **SRS airbag precautions**

Observe the following precautions regarding the airbags.
Failure to do so may cause death or serious injury.

- The driver and all passengers in the vehicle must wear their seat belts properly.

The SRS airbags are supplemental devices to be used with the seat belts.

- The SRS driver airbag deploys with considerable force, and can cause death or serious injury especially if the driver is very close to the airbag. The National Highway Traffic Safety Administration (“NHTSA”) advises:

Since the risk zone for driver airbag is the first 2 - 3 in. (50 - 75 mm) of inflation, placing yourself 10 in. (250 mm) from your driver airbag provides you with a clear margin of safety. This distance is measured from the center of the steering wheel to your breastbone. If you sit less than 10 in. (250 mm) away now, you can change your driving position in several ways:

- Move your seat to the rear as far as you can while still reaching the pedals comfortably.
- Slightly recline the back of the seat.

Although vehicle designs vary, many drivers can achieve the 10 in. (250 mm) distance, even with the driver seat all the way forward, simply by reclining the back of the seat somewhat. If reclining the back of your seat makes it hard to see the road, raise yourself by using a firm, non-slippery cushion, or raise the seat if your vehicle has that feature.

- If your steering wheel is adjustable, tilt it downward. This points the airbag toward your chest instead of your head and neck.

The seat should be adjusted as recommended by NHTSA above, while still maintaining control of the foot pedals, steering wheel, and your view of the instrument panel controls.

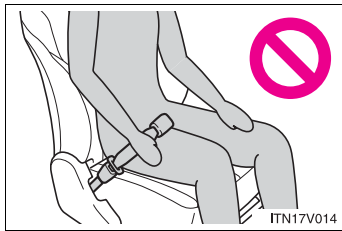
⚠ CAUTION**■ SRS airbag precautions**

- If the seat belt extender has been connected to the front seat belt buckles but the seat belt extender has not also been fastened to the latch plate of the seat belt, the SRS front airbags will judge that the driver and front passenger are wearing the seat belt even though the seat belt has not been connected. In this case, the SRS front airbags may not activate correctly in a collision, resulting in death or serious injury in the event of a collision. Be sure to wear the seat belt with the seat belt extender.
- The SRS front passenger airbag also deploys with considerable force, and can cause death or serious injury especially if the front passenger is very close to the airbag. The front passenger seat should be as far from the airbag as possible with the seatback adjusted, so the front passenger sits upright.
- Improperly seated and/or restrained infants and children can be killed or seriously injured by a deploying airbag. An infant or child who is too small to use a seat belt should be properly secured using a child restraint system. Toyota strongly recommends that all infants and children be placed in the rear seats of the vehicle and properly restrained. The rear seats are the safest for infants and children. (→P. 140)

1

Before driving

⚠ CAUTION

■ SRS airbag precautions

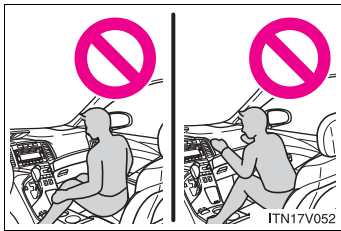

- Do not sit on the edge of the seat or lean against the dashboard.

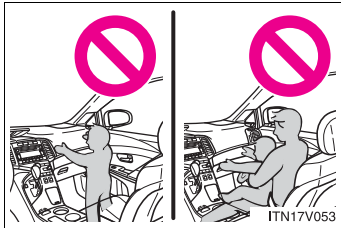

- Do not allow a child to stand in front of the SRS front passenger airbag unit or sit on the knees of a front passenger.
- Do not drive the vehicle while the driver or passenger have items resting on their knees.





- Do not lean against the door, the roof side rail or the front, center and rear pillars.



- Do not allow anyone to kneel on the passenger seats toward the door or put their head or hands outside the vehicle.

⚠ CAUTION

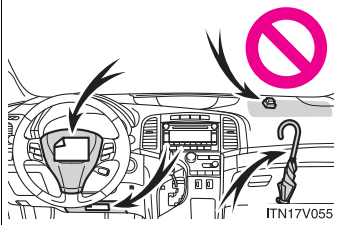
■ SRS airbag precautions

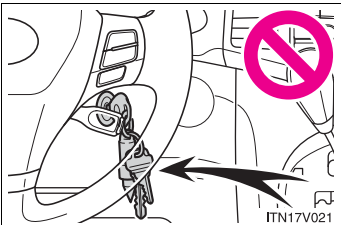
- Do not attach anything to or lean anything against areas such as the dashboard or steering wheel pad or lower portion of the instrument panel. These items can become projectiles when SRS driver, front passenger and knee airbags deploy.
- Do not attach anything to areas such as the door, windshield glass, side door glass, front, center and rear pillars, roof side rail or assist grip.
- Do not hang coat hangers or other hard objects on the coat hooks. All of these items could become projectiles and seriously injure or kill you, should the SRS curtain shield airbag deploy.
- Vehicles without smart key system: Do not attach any heavy, sharp or hard objects such as keys or accessories to the key. The objects may restrict the SRS knee airbag inflation or be thrust into the driver's seat area by the force of the deploying airbag, thus causing a danger.

1

Before driving

 CAUTION

■ **SRS airbag precautions**

- If the vinyl cover is put on the area where the SRS knee airbag will deploy, be sure to remove it.
- Do not use seat accessories which cover the parts where the SRS side airbags inflate as they may interfere with inflation of the airbags.
- Do not strike or apply significant levels of force to the area of the SRS airbag components (→P. 121).
Doing so can cause the SRS airbags to malfunction.
- Do not touch any of the component parts immediately after the SRS airbags have deployed (inflated) as they may be hot.
- If breathing becomes difficult after the SRS airbag has deployed, open a door or window to allow fresh air in, or leave the vehicle if it is safe to do so. Wash off any residue as soon as possible to prevent skin irritation.
- If the areas where the SRS airbags are stored, such as the steering wheel pad and front, center and rear pillar garnishes, are damaged or cracked, have them replaced by your Toyota dealer.

⚠ CAUTION**■ Modification and disposal of SRS airbag system components**

Do not dispose of your vehicle or perform any of the following modifications without consulting your Toyota dealer.

The SRS airbag may malfunction or deploy (inflate) accidentally, causing death or serious injury.

- Installation, removal, disassembly and repair of the SRS airbags
- Repairs, modifications, removal or replacement of the steering wheel, instrument panel, dashboard, seats or seat upholstery, front, center and rear pillars or roof side rail
- Repairs or modifications of the front fender, front bumper, or side of the occupant compartment
- Installation of a grille guard (bull bars, kangaroo bar, etc.), snow plows or winches
- Modifications to the vehicle's suspension system
- Installation of electronic devices such as mobile two-way radios or CD players
- Modifications to your vehicle for a person with a physical disability

1

Before driving

1-7. Safety information

Front passenger occupant classification system

Your vehicle is equipped with a front passenger occupant classification system. This system detects the conditions of the front passenger seat and activates or deactivates the devices for front passenger.

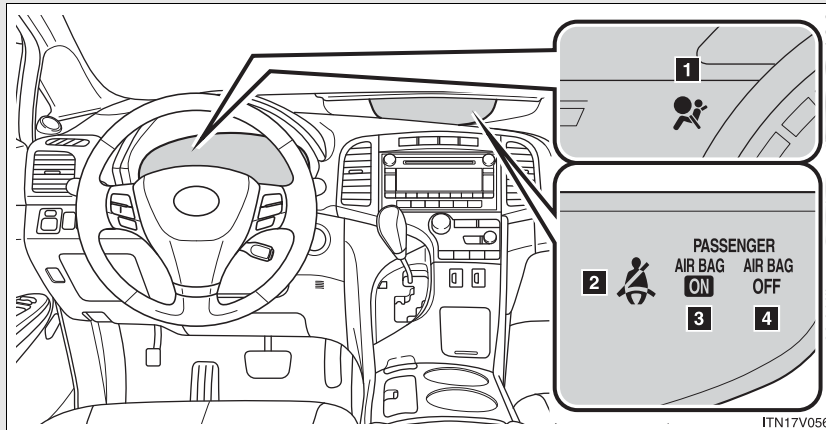

- 1** SRS warning light
- 2** Front passenger's seat belt reminder light
- 3** "AIR BAG ON" indicator light
- 4** "AIR BAG OFF" indicator light

Condition and operation in the front passenger occupant classification system

■ **Adult*1**

Indicator/ warning light	“AIR BAG ON” and “AIR BAG OFF” indicator lights	“AIR BAG ON”
	SRS warning light	Off
	Front passenger’s seat belt reminder light	Flashing*2
Devices	Front passenger airbag	Activated
	Side airbag on the front passenger seat	
	Curtain shield airbag in the front passenger side	
	Front passenger’s seat belt pretensioner	

1
Before driving

■ **Child*3 or child restraint system*4**

Indicator/ warning light	“AIR BAG ON” and “AIR BAG OFF” indicator lights	“AIR BAG OFF”*5
	SRS warning light	Off
	Front passenger’s seat belt reminder light	Flashing*2
Devices	Front passenger airbag	Deactivated
	Side airbag on the front passenger seat	Activated
	Curtain shield airbag in the front passenger side	
	Front passenger’s seat belt pretensioner	

1-7. Safety information

■ **Unoccupied**

Indicator/ warning light	“AIR BAG ON” and “AIR BAG OFF” indicator lights	Not illumi- nated
	SRS warning light	Off
	Front passenger’s seat belt reminder light	
Devices	Front passenger airbag	Deactivated
	Side airbag on the front passenger seat	Activated
	Curtain shield airbag in the front passenger side	
	Front passenger’s seat belt pretensioner	Activated* ⁶ or deactivated

■ System malfunction

Indicator/ warning light	“AIR BAG ON” and “AIR BAG OFF” indicator lights	
	SRS warning light	On
	Front passenger’s seat belt reminder light	Off
Devices	Front passenger airbag	Deactivated
	Side airbag on the front passenger seat	Activated
	Curtain shield airbag in the front passenger side	
	Front passenger’s seat belt pretensioner	

1

Before driving

- *1: The system judges a person of adult size as an adult. When a smaller adult sits in the front passenger seat, the system may recognize him/her as a child depending on his/her physique and posture.
- *2: In the event the front passenger does not wear a seat belt.
- *3: When a larger child who has outgrown a child restraint system sits in the front passenger seat, the system may recognize him/her as an adult depending on his/her physique or posture.
- *4: Never install a rear-facing child restraint system on the front passenger seat. A forward-facing child restraint system should only be installed on the front passenger seat when it is unavoidable.
(→P. 140)
- *5: In case the indicator is not illuminated, consult this manual as for installing the child restraint system properly. (→P. 146)
- *6: In the event of a side collision.

 CAUTION

■ **Front passenger occupant classification system precautions**

Observe the following precautions regarding front passenger occupant classification system.

Failure to do so may cause death or serious injury.

- Wear the seat belt properly.
- Make sure the front passenger's seat belt tab has not been left inserted into the buckle before someone sits in the front passenger seat.
- Make sure the "AIR BAG OFF" indicator light is not illuminated when using the seat belt extender for the front passenger seat. If the "AIR BAG OFF" indicator light is illuminated, disconnect the extender tongue from the seat belt buckle, then reconnect the seat belt. Reconnect the seat belt extender after making sure the "AIR BAG ON" indicator light is illuminated. If you use the seat belt extender while the "AIR BAG OFF" indicator light is illuminated, the SRS airbags for the passenger may not activate correctly, which could cause death or serious injury in the event of collision.
- Do not apply a heavy load to the front passenger seat or equipment (e.g. seatback pocket).
- Do not put weight on the front passenger seat by putting your hands or feet on the front passenger seatback from the rear passenger seat.
- Do not let a rear passenger lift the front passenger seat with their feet or press on the seatback with their legs.
- Do not put objects under the front passenger seat.

⚠ CAUTION**■ Front passenger occupant classification system precautions**

- Do not recline the front passenger seatback so far that it touches a second seat. This may cause the “AIR BAG OFF” indicator light to be illuminated, which indicates that the passenger’s airbags will not deploy in the event of a severe accident. If the seatback touches the second seat, return the seatback to a position where it does not touch the second seat. Keep the front passenger seatback as upright as possible when the vehicle is moving. Reclining the seatback excessively may lessen the effectiveness of the seat belt system.
- If an adult sits in the front passenger seat, the “AIR BAG ON” indicator light is illuminated. If the “AIR BAG OFF” indicator is illuminated, ask the passenger to sit up straight, well back in the seat, feet on the floor, and with the seat belt worn correctly. If the “AIR BAG OFF” indicator still remains illuminated, either ask the passenger to move to the rear seat, or if that is not possible, move the front passenger seat fully rearward.
- When it is unavoidable to install the forward-facing child restraint system on the front passenger seat, install the child restraint system on the front passenger seat in the proper order. (→P. 146)
- Do not modify or remove the front seat.
- Do not kick the front passenger seat or subject it to severe impact. Otherwise, the SRS warning light may come on to indicate a malfunction in the detection system. In this case, contact your Toyota dealer immediately.
- Child restraint systems installed on the rear seat should not contact the front seatbacks.
- Do not use a seat accessory, such as a cushion or seat cover, that covers the seat cushion surface.
- Do not modify or replace the upholstery of the front seat.

1

Before driving

1-7. Safety information

Child restraint systems

A child restraint system for a small child or baby must itself be properly restrained on the seat with the LATCH anchors or the lap portion of the lap/shoulder belt.

The laws of all 50 states of the U.S.A. and Canada now require the use of child restraint systems.

Points to remember

Studies have shown that installing a child restraint on a rear seat is much safer than installing one to the front passenger seat.

- Choose a child restraint system that suits your vehicle and is appropriate to the age and size of the child.
- For installation details, follow the instructions provided with the child restraint system.
General installation instructions are provided in this manual.
(→P. 146)

Types of child restraints

Child restraint systems are classified into the following 3 types according to the age and size of the child.

- ▶ Rear facing — Infant seat/convertible seat

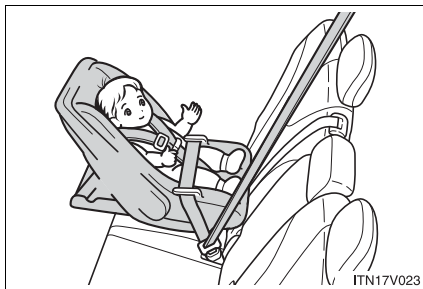

- ▶ Forward facing — Convertible seat

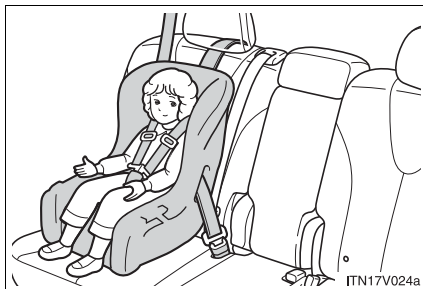

1-7. Safety information

▶ Booster seat



■ When installing the child restraint system on the front passenger seat



When you have to use a child restraint system on the front passenger seat, adjust the following:

- The seatback to the most upright position
- The seat cushion to the fully rearward
- The seat belt height to the lowest position

■ Selecting an appropriate child restraint system

- Use a child restraint system appropriate for the child until the child becomes large enough to properly wear the vehicle's seat belt.
- If a child is too large for a child restraint system, sit the child on a rear seat and use the vehicle's seat belt. (→P. 81)

⚠ CAUTION**■ Child restraint precautions**

- For effective protection in automobile accidents and sudden stops, a child must be properly restrained, using a seat belt or child restraint system depending on the age and size of the child. Holding a child in your arms is not a substitute for a child restraint system. In an accident, the child can be crushed against the windshield, or between you and the vehicle's interior.
- Toyota strongly urges the use of a proper child restraint system that conforms to the size of the child, installed on the rear seat. According to accident statistics, the child is safer when properly restrained in the rear seat than in the front seat.
- Never install a rear-facing child restraint system on the front passenger seat even if "AIR BAG OFF" indicator light illuminates. In the event of an accident, the force of the rapid inflation of the front passenger airbag can cause death or serious injury to the child if the rear-facing child restraint system is installed on the front passenger seat.
- A forward-facing child restraint system may be installed on the front passenger seat only when it is unavoidable. A child restraint system that requires a top tether strap should not be used in the front passenger seat since there is no top tether strap anchor for the front passenger seat. Adjust the seatback as upright as possible and always move the seat as far back as possible even if "AIR BAG OFF" indicator light is illuminated, because the front passenger airbag could inflate with considerable speed and force. Otherwise, the child may be killed or seriously injured.

1

Before driving

 CAUTION

■ **Child restraint precautions**

- Do not use the seat belt extender when installing a child restraint system on the front or rear passenger seat. If installing a child restraint system with the seat belt extender connected to the seat belt, the seat belt will not securely hold the child restraint system, which could cause death or serious injury to the child or other passengers in the event of a sudden stop, sudden swerve or an accident.
- Do not allow the child to lean his/her head or any part of his/her body against the door or the area of the seat, front, center and rear pillars or roof side rail from which the side airbags or curtain shield airbags deploy even if the child is seated in the child restraint system. It is dangerous if the side airbags and curtain shield airbags inflate, and the impact could cause death or serious injury to the child.
- Make sure you have complied with all installation instructions provided by the child restraint manufacturer and that the system is properly secured. If it is not secured properly, it may cause death or serious injury to the child in the event of a sudden stop, sudden swerve or an accident.

■ **When children are in the vehicle**

Do not allow children to play with the seat belt. If the belt becomes twisted around a child's neck, it may lead to choking or other serious injuries that could result in death.

If this occurs and the buckle cannot be unfastened, scissors should be used to cut the belt.

 CAUTION

■ **When the child restraint system is not in use**

- Keep the child restraint system properly secured on the seat even if it is not in use. Do not store the restraint unsecured in the passenger compartment.
- If it is necessary to detach the child restraint system, remove it from the vehicle or store it securely in the luggage compartment. This will prevent it from injuring passengers in the event of a sudden stop, sudden swerve or an accident.

1

Before driving

1-7. Safety information Installing child restraints

Follow the child restraint system manufacturer's instructions. Firmly secure child restraints to the rear seats using the LATCH anchors or a seat belt. Attach the top tether strap when installing a child restraint.

The lap/shoulder belt can be used if your child restraint system is not compatible with the LATCH (Lower Anchors and Tethers for Children) system.

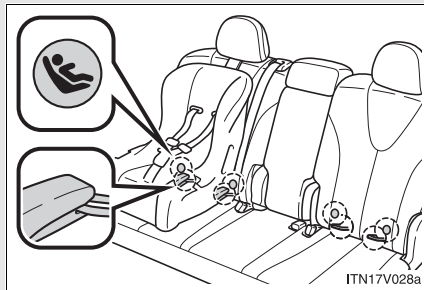

Child restraint LATCH anchors

LATCH anchors are provided for the outboard rear seats. (Buttons displaying the location of the anchors are attached to the seats.)

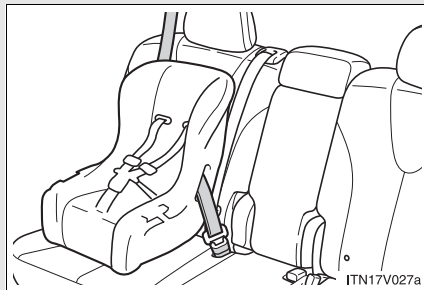

Seat belts equipped with a child restraint locking mechanism (ALR/ELR belts except driver's seat belt) (→P. 81)

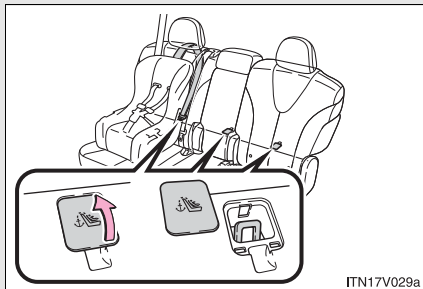

Anchor bracket (for top tether strap)

Anchor brackets are provided for all rear seats.

1

Before driving

Installation with LATCH system

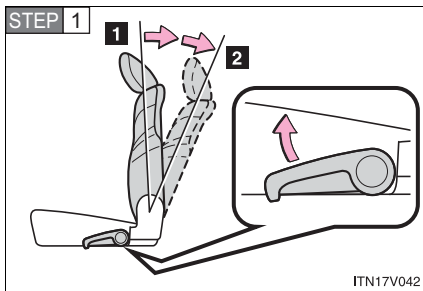

Fold the seatback while pulling the lever. Return the seatback and secure it as upright as possible (1st lock position). Adjust the seatback to the 3rd lock position. (→P. 70)

- 1** 1st lock position
- 2** 3rd lock position

1-7. Safety information

► Type A

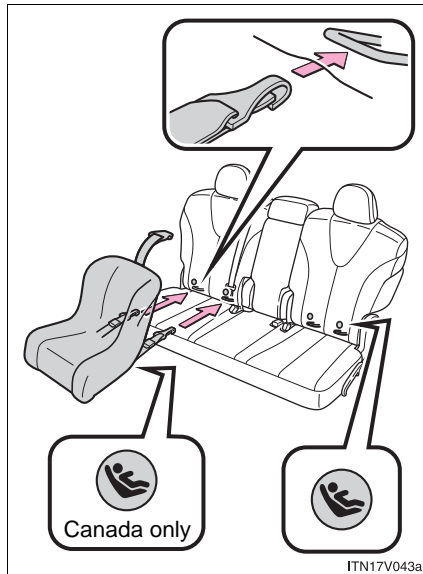

STEP 2 Widen the gap between the seat cushion and seatback slightly.

STEP 3 Latch the hooks of the lower straps onto the LATCH anchors.

The bars are installed in the clearance between the seat cushion and seatback.

STEP 4 If the child restraint has a top tether strap, the top tether strap should be latched onto the top tether strap anchor.

For owners in Canada:

The symbol on a child restraint system indicates the presence of a lower anchorage system.

► Type B

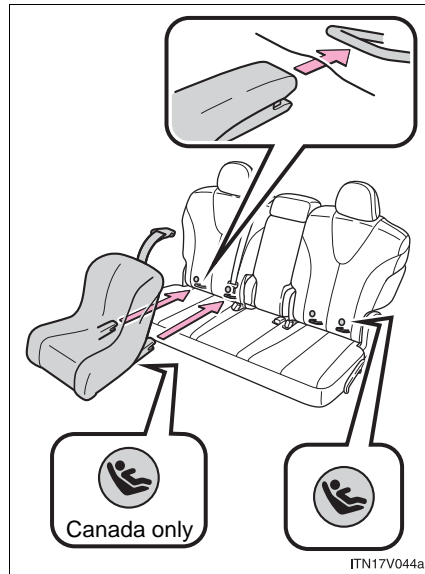

STEP 2 Widen the gap between the seat cushion and seatback slightly.

STEP 3 Latch the buckles onto the LATCH anchors.

The bars are installed in the clearance between the seat cushion and seatback.

STEP 4 If the child restraint has a top tether strap, the top tether strap should be latched onto the top tether strap anchor.

For owners in Canada:
The symbol on a child restraint system indicates the presence of a lower anchorage system.

1

Before driving

Installing child restraints using a seat belt (child restraint lock function belt)

■ **Rear-facing — Infant seat/convertible seat**

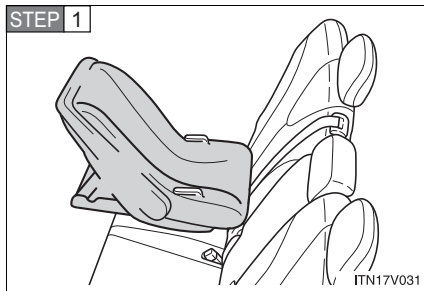

Place the child restraint system on the rear seat facing the rear of the vehicle.

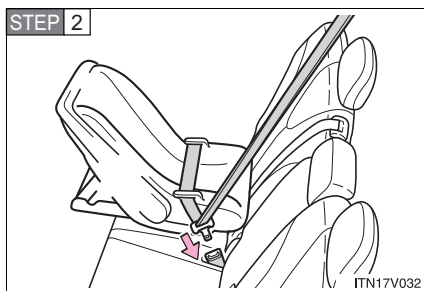

Run the seat belt through the child restraint system and insert the plate into the buckle. Make sure that the belt is not twisted.

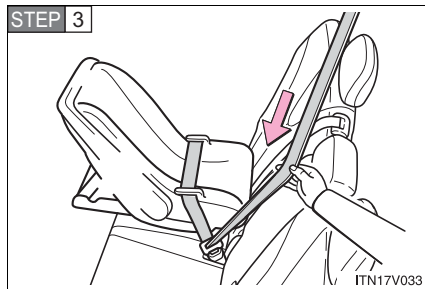

Fully extend the shoulder belt and then allow it to retract slightly in order to activate the ALR lock mode.

Lock mode allows the seat belt to retract only.

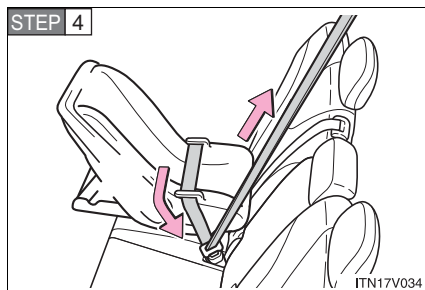

While pushing the child restraint system down into the rear seat, allow the shoulder belt to retract until the child restraint system is securely in place.

After the shoulder belt has retracted to a point where there is no slack in the belt, pull the belt to check that it cannot be extended.

1

Before driving

1-7. Safety information

■ **Forward-facing — Convertible seat**

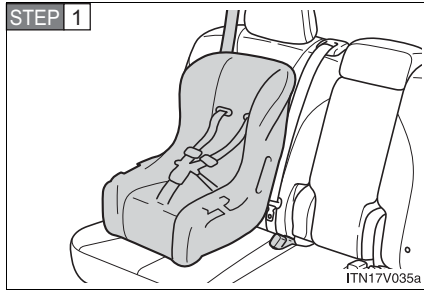

Place the child restraint system on the seat facing the front of the vehicle.

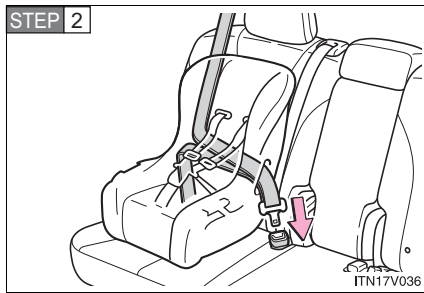

Run the seat belt through the child restraint system and insert the plate into the buckle. Make sure that the belt is not twisted.

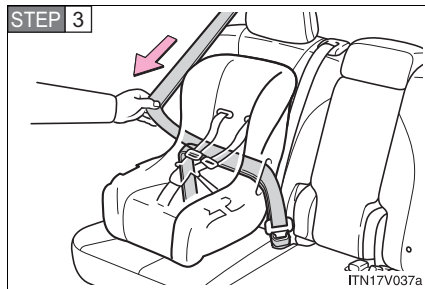

Fully extend the shoulder strap and then allow it to retract slightly into the ALR lock mode.

Lock mode allows the seat belt to retract only.

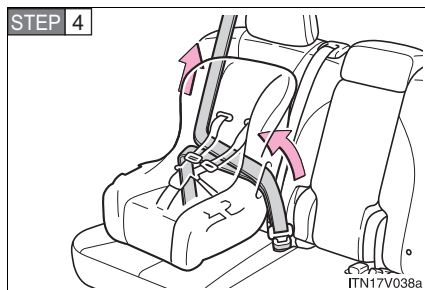

While pushing the child restraint system into the rear seat, allow the shoulder belt to retract until the child restraint system is securely in place.

After the shoulder belt has retracted to a point where there is no slack in the belt, pull the belt to check that it cannot be extended.

STEP 5 If the child restraint has a top tether strap, the top tether strap should be latched onto the top tether strap anchor. (→P. 155)

1

Before driving

■ **Booster seat**

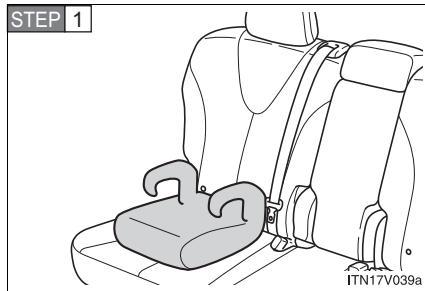

Place the booster seat on the seat facing the front of the vehicle.

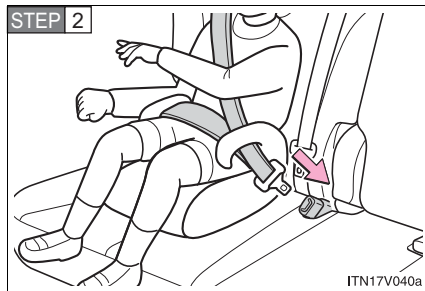

Sit the child in the booster seat. Fit the seat belt to the booster seat according to the manufacturer's instructions and insert the plate into the buckle. Make sure that the belt is not twisted.

Check that the shoulder belt is correctly positioned over the child's shoulder, and that the lap belt is as low as possible.
(→P. 81)

Removing a child restraint installed with a seat belt

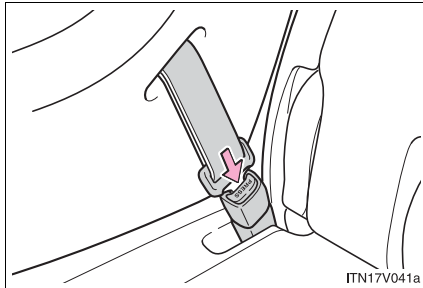

Press the buckle release button and fully retract the seat belt.

1

Before driving

Child restraint systems with a top tether strap

STEP 1 Secure the child restraint using a seat belt or lower anchors, and do the following.

► Outside

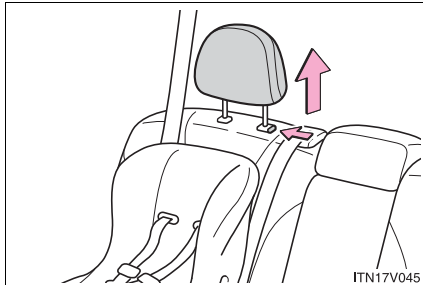

Adjust the head restraint to the upmost position.

► Center

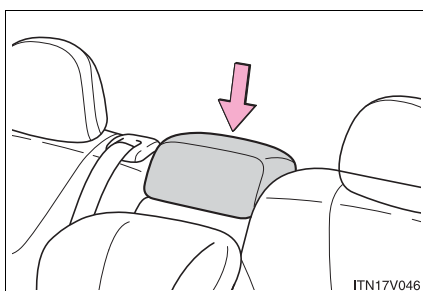

Lower the head restraint to the lowest position.

1-7. Safety information

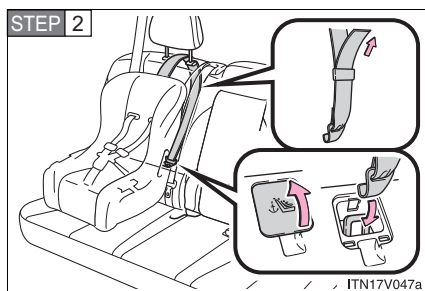

Open the anchor bracket cover, latch the hook onto the anchor bracket and tighten the top tether strap.

Make sure the top tether strap is securely latched.

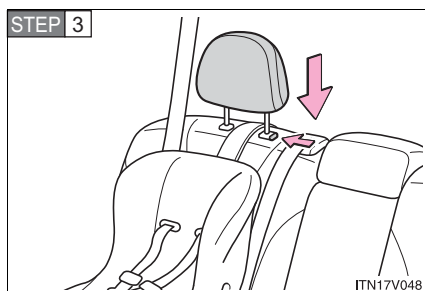

Outside only: Adjust the head restraint to the downmost position.

■ Laws and regulations pertaining to anchors

The LATCH system conforms to FMVSS225 or CMVSS210.2.

Child restraint systems conforming to FMVSS213 or CMVSS213 specifications can be used.

This vehicle is designed to conform to the SAE J1819.

⚠ CAUTION

■ When installing a booster seat

Do not fully extend the shoulder belt to prevent the belt from going to ALR lock mode: (→P. 83)

ALR mode causes the belt to tighten only which could cause injury or discomfort to the child.

⚠ CAUTION**■ When installing a child restraint system**

Follow the directions given in the child restraint system installation manual and fix the child restraint system securely in place.

If the child restraint system is not correctly fixed in place, the child or other passengers may be seriously injured or even killed in the event of sudden braking, sudden swerving or an accident.

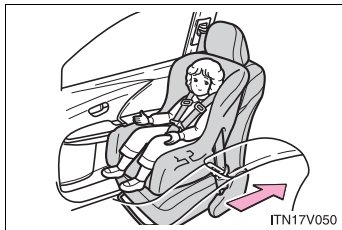
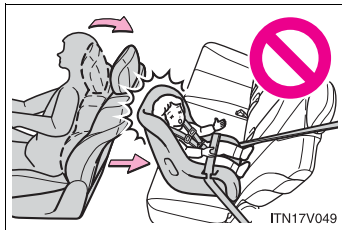

- If the driver's seat interferes with the child restraint system and prevents it from being attached correctly, attach the child restraint system to the right-hand rear seat.
- Adjust the front passenger seat so that it does not interfere with the child restraint system.
- Only put a forward-facing child restraint system on the front seat when unavoidable. When installing a forward-facing child restraint system on the front passenger seat, move the seat as far back as possible even if the "AIR BAG OFF" indicator light is illuminated. Failing to do so may result in death or serious injury if the airbags deploy (inflate).

1

Before driving

 CAUTION

■ **When installing a child restraint system**

- When installing a child restraint system in the rear center seat, adjust both seatbacks at the same angle. Otherwise, the child restraint system cannot be securely restrained and this may cause death or serious injuries in the event of sudden braking, sudden swerving or an accident.
- When using the LATCH anchors for a child restraint system, adjust the seatback as upright as possible.
- When a booster seat is installed, always ensure that the shoulder belt is positioned across the center of the child's shoulder. The belt should be kept away from the child's neck, but not so that it could fall off the child's shoulder. Failing to do so may result in death or serious injury in the event of sudden braking, sudden swerving or an accident.
- Ensure that the belt and tab are securely locked and the seat belt is not twisted.
- Shake the child restraint system left and right, and forward and backward to ensure that it has been securely installed.
- After securing a child restraint system, never adjust the seat.
- Follow all installation instructions provided by the child restraint system manufacturer.

 CAUTION

■ **Do not use a seat belt extender**

If a seat belt extender is used when installing a child restraint system, the seat belt will not securely hold the child restraint system, which could cause death or serious injury to the child or other passengers in the event of sudden braking, sudden swerving or an accident.

■ **To correctly attach a child restraint system to the anchors**

When using the LATCH anchors, be sure that there are no foreign objects around the anchors and that the seat belt is not caught behind the child restraint. Make sure the child restraint system is securely attached, or it may cause death or serious injury to the child or other passengers in the event of a sudden stop, sudden swerve or an accident.

1

Before driving

1-7. Safety information

2-1. Driving procedures

Driving the vehicle..... 162
 Engine (ignition) switch
 (vehicles with smart
 key system)..... 173
 Engine (ignition) switch
 (vehicles without smart
 key system)..... 177
 Automatic
 transmission..... 180
 Turn signal lever 185
 Parking brake..... 186
 Horn 187

2-2. Instrument cluster

Gauges and meters 188
 Indicators and warning
 lights 191
 Multi-information display
 (TFT type) 194
 Multi-information display
 (LCD type) 206
 Fuel consumption
 information 210

**2-3. Operating the lights
 and wipers**

Headlight switch 212
 Automatic High Beam 216
 Fog light switch 223
 Windshield wipers
 and washer 225
 Rear window wiper
 and washer 229

2-4. Using other driving systems

Cruise control..... 231
 Intuitive parking assist..... 235
 Rear view monitor
 system 243
 Driving assist systems 256
 Hill-start assist control..... 262

2-5. Driving information

Utility vehicle
 precautions 264
 Cargo and luggage 269
 Vehicle load limits 274
 Winter driving tips 276
 Trailer towing 281
 Dinghy towing 302

2-1. Driving procedures

Driving the vehicle

The following procedures should be observed to ensure safe driving.

■ Starting the engine

→P. 173, 177

■ Driving

STEP 1 With the brake pedal depressed, shift the shift lever to “D”.
(→P. 180)

STEP 2 Release the parking brake. (→P. 186)

STEP 3 Gradually release the brake pedal and gently push the accelerator pedal to accelerate the vehicle.

■ Stopping

STEP 1 With the shift lever in “D”, depress the brake pedal.

STEP 2 If necessary, set the parking brake.

When the vehicle is stopped for an extended period of time, shift the shift lever to “P” or “N”. (→P. 180)

■ Parking the vehicle

STEP 1 With the shift lever in “D”, depress the brake pedal.

STEP 2 Set the parking brake. (→P. 186)

STEP 3 Shift the shift lever to “P”. (→P. 180)

When parking on a hill, if necessary, block the wheels.

- STEP 4** Vehicles with smart key system:
Turn the “ENGINE START STOP” switch off and stop the engine.
- Vehicles without smart key system:
Turn the engine switch to the “LOCK” position and stop the engine.
- STEP 5** Lock the door, making sure that you have the key on your person.

2

When driving

Starting on a steep incline

- STEP 1** Firmly set the parking brake and shift the shift lever to “D”.
- STEP 2** Gently depress the accelerator pedal.
- STEP 3** Release the parking brake.

Starting off on a hill

Hill-start assist control will operate. (→P. 262)

Driving in the rain

- Drive carefully when it is raining, because visibility will be reduced, the windows may become fogged-up, and the road will be slippery.
- Drive carefully when it starts to rain, because the road surface will be especially slippery.
- Refrain from high speeds when driving on an expressway in the rain, because there may be a layer of water between the tires and the road surface, preventing the steering and brakes from operating properly.

2-1. Driving procedures

■ Engine speed while driving

In the following conditions, the engine speed may become high while driving. This is due to automatic up-shifting control or down-shifting implementation to meet driving conditions. It does not indicate sudden acceleration.

- The vehicle is judged to be driving uphill or downhill
- When the accelerator pedal is released

■ Breaking in your new Toyota

To extend the life of the vehicle, the following precautions are recommended to observe:

- For the first 200 miles (300 km):
Avoid sudden stops.
- For the first 500 miles (800 km):
Do not tow a trailer.
- For the first 1000 miles (1600 km):
 - Do not drive at extremely high speeds.
 - Avoid sudden acceleration.
 - Do not drive continuously in the low gears.
 - Do not drive at a constant speed for extended periods.

■ Drum-in-disc type parking brake system

Your vehicle has a drum-in-disc type parking brake system.

This type of brake system needs bedding-down of the brake shoes periodically or whenever the parking brake shoes and/or drums are replaced.

Have your Toyota dealer perform the bedding-down.

■ Operating your vehicle in a foreign country

Comply with the relevant vehicle registration laws and confirm the availability of the correct fuel. (→P. 615)

⚠ CAUTION**■ When starting the vehicle**

Always keep your foot on the brake pedal while stopped with the engine running. This prevents the vehicle from creeping.

■ When driving the vehicle

- Do not drive if you are unfamiliar with the location of the brake and accelerator pedals to avoid depressing the wrong pedal.
 - Accidentally depressing the accelerator pedal instead of the brake pedal will result in sudden acceleration that may lead to an accident that could result in death or serious injury.
 - When backing up, you may twist your body around, leading to a difficulty in operating the pedals. Make sure to operate the pedals properly.
 - Make sure to keep a correct driving posture even when moving the vehicle only slightly, allowing you to depress the brake and accelerator pedals properly.
 - Depress the brake pedal using your right foot. Depressing the brake pedal using your left foot may delay response in an emergency, resulting in an accident.
- Do not drive the vehicle over or stop the vehicle near flammable materials. The exhaust system and exhaust gases can be extremely hot. This may cause a fire if there is any flammable material nearby.
- Do not let the vehicle roll backward while the shift lever is in a driving position, or roll forward while the shift lever is in "R". Doing so may result in an accident or damage to the vehicle.
- If the smell of exhaust is noticed inside the vehicle, open the windows and check that the back door is closed. Large amounts of exhaust in the vehicle can cause driver drowsiness and an accident, resulting in death or a serious health hazard. Have the vehicle inspected by your Toyota dealer immediately.

 CAUTION

- Do not shift the shift lever to “P” while the vehicle is moving.
Doing so can damage the transmission and may result in a loss of vehicle control.
- Do not shift the shift lever to “R” while the vehicle is moving forward.
Doing so can damage the transmission and may result in a loss of vehicle control.
- Do not shift the shift lever to “D” while the vehicle is moving backward.
Doing so can damage the transmission and may result in a loss of vehicle control.
- Moving the shift lever to “N” while the vehicle is moving will disengage the engine from the transmission. Engine braking is not available when “N” is selected.
- During normal driving, do not turn off the engine. Turning the engine off while driving will not cause loss of steering or braking control, however, power assist to the steering will be lost. This will make it more difficult to steer smoothly, so you should pull over and stop the vehicle as soon as it is safe to do so.
In the event of an emergency, such as if it becomes impossible to stop the vehicle in the normal way: →P. 608.
- Use engine braking (downshift) to maintain a safe speed when driving down a steep hill.
Using the brakes continuously may cause the brakes to overheat and lose effectiveness. (→P. 181)
- When stopped on an inclined surface, use the brake pedal and parking brake to prevent the vehicle from rolling backward or forward and causing an accident.

⚠ CAUTION

- Do not adjust the position of the steering wheel, the seat, or the inside or outside rear view mirrors while driving. Doing so may result in a loss of vehicle control that can cause accidents that may result in death or serious injury.

- Always check that all passengers' arms, heads or other parts of their bodies are not outside the vehicle, as this may result in death or serious injury.

- Do not drive in excess of the speed limit. Even if the legal speed limit permits it, do not drive over 85 mph (140 km/h) unless your vehicle has high-speed capability tires. Driving over 85 mph (140 km/h) may result in tire failure, loss of control and possible injury. Be sure to consult a tire dealer to determine whether the tires on your vehicle are high-speed capability tires or not before driving at such speeds.

- **When driving on slippery road surfaces**

- Sudden braking, acceleration and steering may cause tire slippage and reduce your ability to control the vehicle, resulting in an accident.

- Sudden acceleration, engine braking due to shifting, or changes in engine speed could cause the vehicle to skid, resulting in an accident.

- After driving through a puddle, lightly depress the brake pedal to make sure that the brakes are functioning properly. Wet brake pads may prevent the brakes from functioning properly. If the brakes on only one side are wet and not functioning properly, steering control may be affected, resulting in an accident.

- **When shifting the shift lever**

Be careful not to shift the shift lever with the accelerator pedal depressed. This may lead to unexpected rapid acceleration of the vehicle that may cause an accident and result in death or serious injury.

 CAUTION

■ **If you hear a squealing or scraping noise (brake pad wear limit indicators)**

Have your Toyota dealer check and replace the brake pads as soon as possible.

The rotor damage can result if the pads are not replaced when needed.

It is dangerous to drive the vehicle when the wear limits of the brake pads and/or that of the brake discs are exceeded.

■ **When the vehicle is stopped**

- Do not race the engine.

If the vehicle is in any gear other than “P” or “N”, the vehicle may accelerate suddenly and unexpectedly, and may cause an accident.

- Do not leave the vehicle with the engine running for a long time.

If such a situation cannot be avoided, park the vehicle in an open space and check that exhaust fumes do not enter the vehicle interior.

- In order to prevent accidents due to the vehicle rolling away, always keep depressing the brake pedal while the engine is running, and apply the parking brake as necessary.

- If the vehicle is stopped on an incline, in order to prevent accidents caused by the vehicle rolling forward or backward, always depress the brake pedal and securely apply the parking brake as needed.

- Avoid revving or racing the engine.

Running the engine at high speed while the vehicle is stopped may cause the exhaust system to overheat, which could result in a fire if combustible material is nearby.

⚠ CAUTION**■ When the vehicle is parked**

- Do not leave glasses, cigarette lighters, spray cans, or soft drink cans in the vehicle when it is in the sun.
Doing so may result in the following:
 - Gas may leak from a cigarette lighter or spray can, and may lead to a fire.
 - The temperature inside the vehicle may cause the plastic lenses and plastic material of eye glasses to deform or crack.
 - Soft drink cans may fracture, causing the contents to spray over the interior of the vehicle, and may also cause a short circuit in the vehicle's electrical components.
- Always apply the parking brake, shift the shift lever to "P", stop the engine and lock the vehicle.
Do not leave the vehicle unattended while the engine is running.
- Do not touch the exhaust pipe while the engine is running or immediately after turning the engine off.
Doing so may cause burns.
- Do not leave the engine running in an area with snow build-up, or where it is snowing. If snowbanks build up around the vehicle while the engine is running, exhaust gases may collect and enter the vehicle. This may lead to death or a serious health hazard.

■ Exhaust gases

Exhaust gases include harmful carbon monoxide (CO) that is colorless and odorless. Inhaling exhaust gases may lead to death or a serious health hazard.

- If the vehicle is in a poorly ventilated area, stop the engine. In a closed area, such as a garage, exhaust gases may collect and enter the vehicle. This may lead to death or a serious health hazard.
- The exhaust should be checked occasionally. If there is a hole or crack caused by corrosion, damage to a joint or abnormal exhaust noise, be sure to have the vehicle inspected and repaired by your Toyota dealer. Failure to do so may allow exhaust gases to enter the vehicle, resulting in death or a serious health hazard.

 CAUTION

■ **When taking a nap in the vehicle**

Always turn the engine off. Otherwise, you may accidentally move the shift lever or depress the accelerator pedal, which could cause an accident or fire due to engine overheating. Additionally, if the vehicle is parked in a poorly ventilated area, exhaust gases may collect and enter the vehicle, leading to death or a serious health hazard.

■ **When braking the vehicle**

- When the brakes are wet, drive more cautiously.

Braking distance increases when the brakes are wet, and may cause one side of the vehicle to brake differently than the other side. Also the parking brake may not securely hold the vehicle.

- If the power brake assist function does not operate, do not follow other vehicles closely and avoid hills or sharp turns that require braking.

In this case, braking is still possible, but the brake pedal should be depressed more firmly than usual. Also, the braking distance will increase. Have your brakes fixed immediately.

- Do not pump the brake pedal if the engine stalls.

Each push on the brake pedal uses up the reserve for the power-assisted brakes.

- The brake system consists of 2 individual hydraulic systems; if one of the systems fails, the other will still operate. In this case, the brake pedal should be depressed more firmly than usual and the braking distance will increase.

Have your brakes fixed immediately.

■ **If the vehicle becomes stuck or bogged (AWD models)**

Do not spin the wheels recklessly when any of the tires is up in the air, or stuck in sand or mud, etc. This may damage the drive system components or propel the vehicle forward (or in another direction) and cause an accident.

 NOTICE

■ **While driving the vehicle**

- Do not depress the accelerator and brake pedals at the same time during driving, as this may restrain driving torque.
- Do not use the accelerator pedal or depress accelerator and brake pedals together to hold the vehicle on a hill.

■ **When parking the vehicle**

Always put the shift lever in "P". Failure to do so may cause the vehicle to move or the vehicle may accelerate suddenly if the accelerator pedal is accidentally depressed.

■ **Avoiding damage to vehicle parts**

- Do not turn the steering wheel fully in either direction and hold it there for an extended period of time.
Doing so may damage the power steering motor.
- When driving over bumps in the road, drive as slowly as possible to avoid damaging the wheels, underside of the vehicle, etc.

 NOTICE

■ **If you get a flat tire while driving**

A flat or damaged tire may cause the following situations. Hold the steering wheel firmly and gradually press the brake pedal to slow down the vehicle.

- It may be difficult to control your vehicle.
- The vehicle will make abnormal sounds.
- The vehicle will behave abnormally.

Replace a flat tire with a new one. (→P. 579)

■ **When encountering flooded roads**

Do not drive on a road that has flooded after heavy rain etc. Doing so may cause the following serious damage to the vehicle.

- Engine stalling
- Short in electrical components
- Engine damage caused by water immersion

In the event that you drive on a flooded road and the vehicle is flooded, be sure to have your Toyota dealer check the following.

- Brake function
- Changes in quantity and quality of oil and fluid used for the engine, transaxle, transfer (AWD models), differential (AWD models), etc.
- Lubricant condition for the propeller shaft (AWD models), bearings and suspension joints (where possible) and the function of all joints, bearings, etc.

2-1. Driving procedures

Engine (ignition) switch (vehicles with smart key system)

Performing the following operations when carrying the electronic key on your person starts the engine or changes “ENGINE START STOP” switch modes.

■ Starting the engine

STEP 1 Check that the parking brake is set.

STEP 2 Check that the shift lever is set in “P”.

STEP 3 Sit in the driver’s seat and firmly depress the brake pedal.

The “ENGINE START STOP” switch indicator turns green.

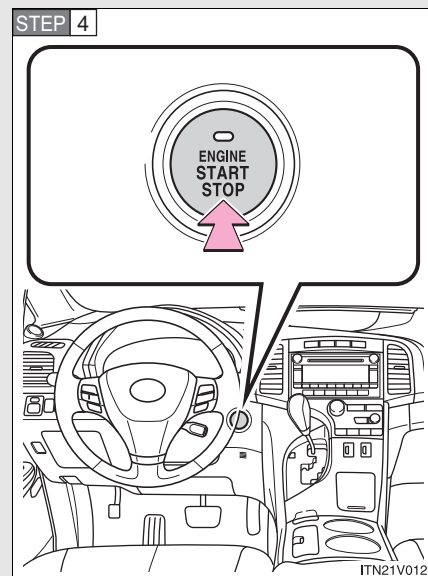

Press the “ENGINE START STOP” switch.

The engine can be started from any “ENGINE START STOP” switch mode.

Continue depressing the brake pedal until the engine is completely started. The engine will crank until it starts or for up to 30 seconds, whichever is less.

2

When driving

■ Changing “ENGINE START STOP” switch mode

Modes can be changed by pressing the “ENGINE START STOP” switch with the brake pedal released. (The mode changes each time the switch is pressed.)

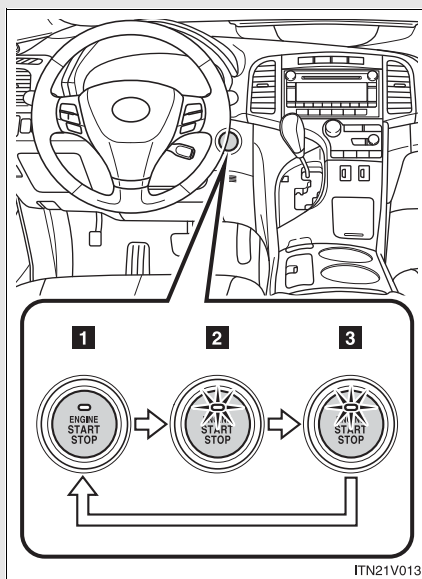

1 Off*

Emergency flashers can be used.

2 ACCESSORY mode

Some electrical components such as the audio system can be used.

The “ENGINE START STOP” switch indicator turns amber.

3 IGNITION ON mode

All electrical components can be used.

The “ENGINE START STOP” switch indicator turns amber.

*: If the shift lever is in a position other than “P” when turning off the engine, the “ENGINE START STOP” switch will be turned to ACCESSORY mode, not to OFF.

■ **When the steering lock cannot be released**

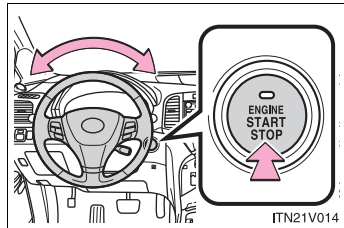

The green indicator light on the “ENGINE START STOP” switch will flash and a message will be shown on the multi-information display (TFT type only). To free it, press the “ENGINE START STOP” switch while turning the steering wheel slightly in either direction.

■ **If the engine does not start**

The engine immobilizer system may not have been deactivated. (→P. 109)
Contact your Toyota dealer.

■ **When the “ENGINE START STOP” switch indicator flashes in amber**

The system may be malfunctioning. Have the vehicle inspected by your Toyota dealer immediately.

■ **Auto power off function**

If the vehicle is left in ACCESSORY or IGNITION ON mode (engine is not running) for more than an hour with the shift lever in “P”, the “ENGINE START STOP” switch will automatically turn off.

■ **Electronic key battery depletion**

→P. 37

■ **When the electronic key battery is discharged**

→P. 595

■ **Conditions affecting operation**

→P. 35

■ **Note for the entry function**

→P. 38

 CAUTION

■ **When starting the engine**

Always start the engine while sitting in the driver's seat. Do not depress the accelerator pedal while starting the engine under any circumstances. Doing so may cause an accident resulting in death or serious injury.

■ **Stopping the engine in an emergency**

If you want to stop the engine in an emergency while driving the vehicle, press and hold the "ENGINE START STOP" switch for more than 2 seconds, or press it briefly 3 times or more in succession. (→P. 608)
However, do not touch the "ENGINE START STOP" switch while driving except in an emergency. Turning the engine off while driving will not cause loss of steering or braking control, however, power assist to the steering will be lost. This will make it more difficult to steer smoothly, so you should pull over and stop the vehicle as soon as it is safe to do so.

 NOTICE

■ **To prevent battery discharge**

Do not leave the "ENGINE START STOP" switch in ACCESSORY or IGNITION ON mode for long periods without the engine running.

■ **When starting the engine**

- Do not race a cold engine.
- If the engine becomes difficult to start or stalls frequently, have your vehicle checked by your Toyota dealer immediately.

2-1. Driving procedures

Engine (ignition) switch (vehicles without smart key system)

■ Starting the engine

- STEP 1** Check that the parking brake is set.
- STEP 2** Check that the shift lever is set in "P".
- STEP 3** Sit in the driver's seat and firmly depress the brake pedal.
- STEP 4** Turn the engine switch to the "START" position and start the engine.

■ Engine (ignition) switch

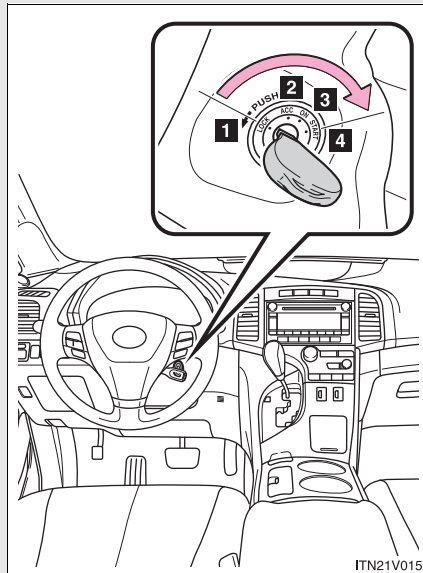

1 "LOCK"

The steering wheel is locked and the key can be removed. (The key can be removed only when the shift lever is in "P".)

2 "ACC"

Some electrical components such as the audio system can be used.

3 "ON"

All electrical components can be used.

4 "START"

For starting the engine.

■ Turning the key from “ACC” to “LOCK”

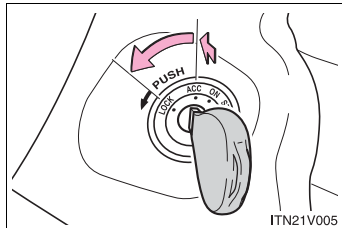

STEP 1 Shift the shift lever to “P”.

STEP 2 Push in the key and turn to the “LOCK” position.

■ When the steering lock cannot be released

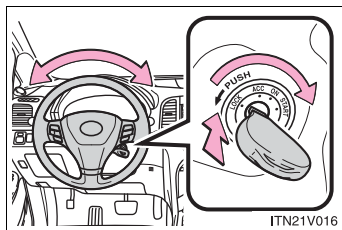

When starting the engine, the engine switch may seem stuck in the “LOCK” position. To free it, turn the key while turning the steering wheel slightly in either direction.

■ If the engine does not start

The engine immobilizer system may not have been deactivated. (→P. 109)

■ Key reminder function

A buzzer sounds if the driver’s door is opened, while the engine switch is in “LOCK” or “ACC” position to remind you to remove the key.

 CAUTION

■ **When starting the engine**

Always start the engine while sitting in the driver's seat. Do not depress the accelerator pedal while starting the engine under any circumstances. Doing so may cause an accident resulting in death or serious injury.

■ **While driving**

Do not turn the engine switch to the "LOCK" position. If in an emergency, you must turn the engine off while the vehicle is moving, turn the key only to the "ACC" position.

 NOTICE

■ **To prevent battery discharge**

Do not leave the key in the "ACC" or "ON" position for long periods without the engine running.

■ **When starting the engine**

- Do not crank for more than 30 seconds at a time. This may overheat the starter and wiring systems.
- Do not race the cold engine.
- If the engine becomes difficult to start or stalls frequently, have the engine checked immediately.

2-1. Driving procedures Automatic transmission

Select a shift position appropriate for the driving conditions.

■ Shifting the shift lever

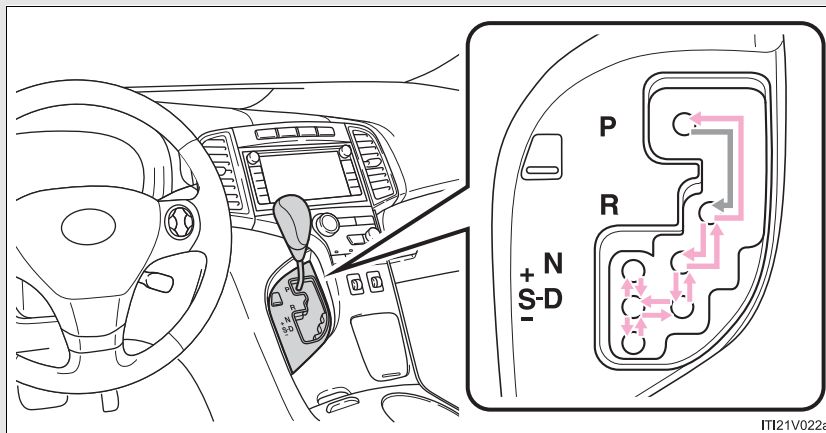

Vehicles with smart key system:

While the “ENGINE START STOP” switch is in IGNITION ON mode, depress the brake pedal and move the shift lever.

Vehicles without smart key system:

While the engine switch is in the “ON” position, depress the brake pedal and move the shift lever.

■ Shift position uses

Shift position	Function
P	Parking the vehicle or starting the engine
R	Reversing
N	Neutral
D	Normal driving ^{*1}
S	S mode driving ^{*2} (→P. 182)

^{*1}: Shifting to the D position allows the system to select a gear suitable for the driving conditions.

Setting the shift lever to the D position is recommended for normal driving.

^{*2}: Selecting shift ranges using S mode restricts the upper limit of the possible gear ranges, controls engine braking forces, and prevents unnecessary upshifting.

2

When driving

Changing shift ranges in S mode

Shift the shift lever to the S mode driving position and operate the shift lever.

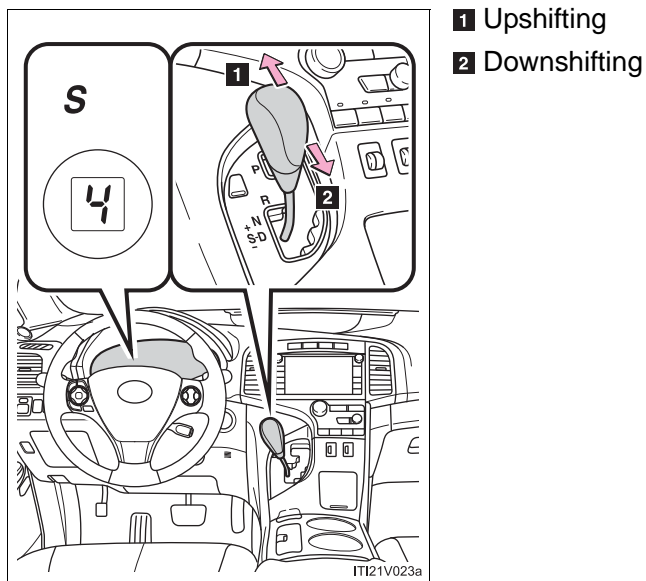

- 1 Upshifting
- 2 Downshifting

The initial shift range in S mode is set automatically to 5 or 4 according to vehicle speed. However, the initial shift range may be set to 3 if AI-SHIFT has operated while the shift lever was in the D position. (→P. 184)

■ **Shift ranges and their functions**

- Automatically selecting gears between 1 and 6 according to vehicle speed and driving condition. (However the gear is limited according to selected shift range.)
- You can choose from 6 levels of engine braking force.
- A lower shift range will provide greater engine braking force than a higher shift range, and the engine speed will also increase.

■ **S mode**

- When the shift range is 5 or lower, holding the shift lever toward “+” sets the shift range to 6.
- To prevent excessive engine speed, a function was adopted that automatically selects a higher shift range before engine speed becomes too high.
- To protect the automatic transmission, a function is adopted that automatically selects a higher shift range when the fluid temperature is high.

■ **Downshifting restrictions warning buzzer (in the S mode)**

To help ensure safety and driving performance, downshifting operation may sometimes be restricted. In some circumstances, downshifting may not be possible even when the shift lever is operated. (The warning buzzer will sound twice.)

■ **When driving with cruise control system**

Even when performing the following actions with the intent of enabling engine braking, engine braking will not activate while driving in S mode and downshifting to 5 or 4 because cruise control will not be canceled. (→P. 231)

■ **If the shift lever cannot be shifted from P**

→P. 593

■ **If the S indicator does not come on even after shifting the shift lever to S mode driving position**

This may indicate a malfunction in the automatic transmission system. Have the vehicle inspected by your Toyota dealer immediately.

(In this situation, the transmission will operate in the same manner as when the shift lever is in D.)

■ **AI-SHIFT**

AI-SHIFT automatically selects the suitable gear according to driver performance and driving conditions.

AI-SHIFT automatically operates when the shift lever is in the D position. (Shifting the shift lever to the S mode driving position cancels the function.)

2-1. Driving procedures

Turn signal lever

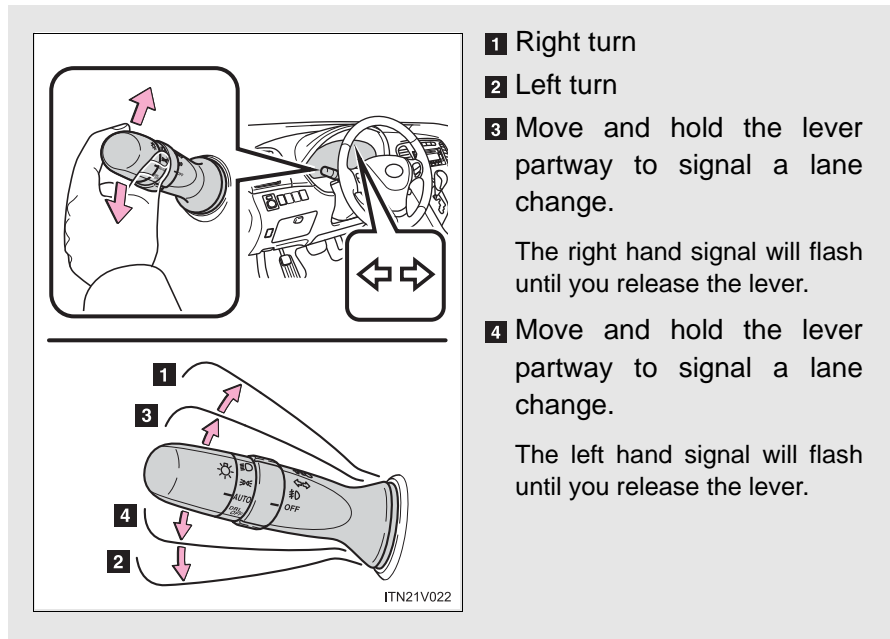

2

When driving

■ Turn signals can be operated when

- ▶ Vehicles with smart key system
The "ENGINE START STOP" switch is in IGNITION ON mode.
- ▶ Vehicles without smart key system
The engine switch is in the "ON" position.

■ If the indicators flash faster than usual

Check that a light bulb in the front or rear turn signal lights has not burned out.

2-1. Driving procedures

Parking brake

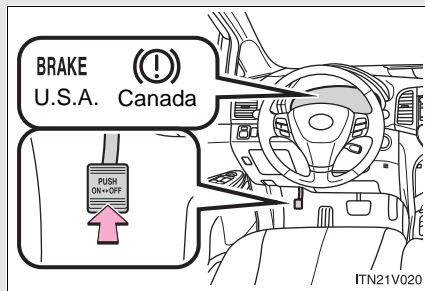

Sets the parking brake*
(Depressing the pedal again releases the parking brake.)

*: Fully depress the parking brake pedal with your left foot while depressing the brake pedal with your right foot.

■ Usage in winter time

→P. 276

⚠ NOTICE

■ Before driving

Fully release the parking brake.

Driving the vehicle with the parking brake set will lead to brake components overheating, which may affect braking performance and increase brake wear.

2-1. Driving procedures

Horn

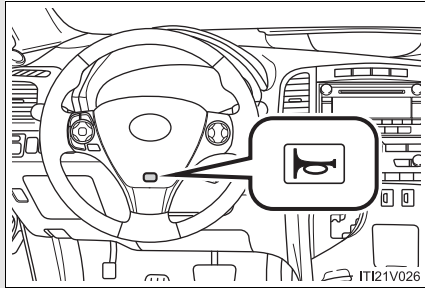

To sound the horn, press on or close to the  mark.

2

When driving

■ After adjusting the steering wheel

Make sure that the steering wheel is securely locked.

The horn may not sound if the steering wheel is not securely locked.

(→P. 88)

2-2. Instrument cluster Gauges and meters

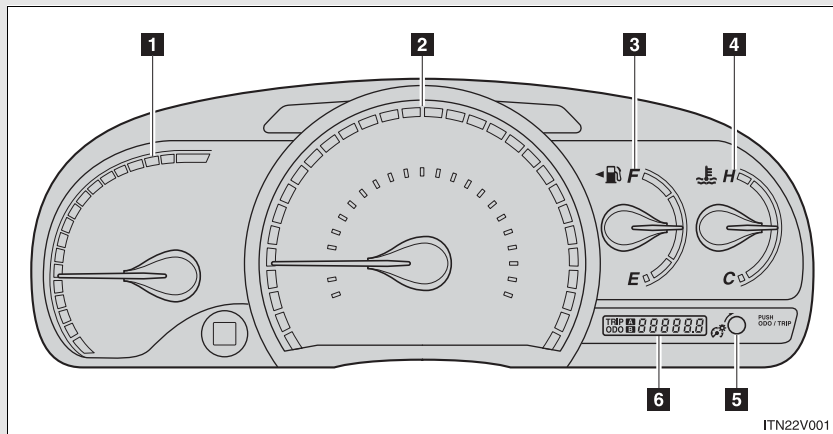

▶ Vehicles with smart key system

The following gauges, meters and display illuminate when the “ENGINE START STOP” switch is in IGNITION ON mode.

▶ Vehicles without smart key system

The following gauges, meters and displays illuminate when the engine switch is in the “ON” position.

1 Tachometer

Displays the engine speed in revolutions per minute.

2 Speedometer

Displays the vehicle speed.

3 Fuel gauge

Displays the quantity of fuel remaining in the tank.

4 Engine coolant temperature gauge

Displays the engine coolant temperature.

5 Odometer/trip meter and trip meter reset button

Switches between odometer and trip meter displays. Pushing and holding the button will reset the trip meter when the trip meter is being displayed.

6 Odometer and trip meter

Odometer: Displays the total distance the vehicle has been driven.

Trip meter: Displays the distance the vehicle has been driven since the meter was last reset. Trip meters A and B can be used to record and display different distances independently.

2

When driving

Instrument panel light control

The brightness of the instrument panel lights can be adjusted.

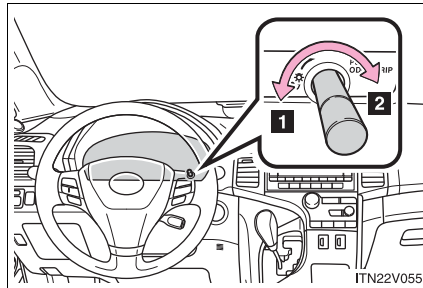

1 Darker

2 Brighter

2-2. Instrument cluster

NOTICE

■ To prevent damage to the engine and its components

- Do not let the indicator needle of the tachometer enter the red zone, which indicates the maximum engine speed.
- The engine may be overheating if the engine coolant temperature gauge is in the red zone ("H"). In this case, immediately stop the vehicle in a safe place, and check the engine after it has cooled completely. (→P. 603)

2-2. Instrument cluster Indicators and warning lights

The indicator and warning lights on the instrument cluster and center panel inform the driver of the status of the vehicle's various systems.

For the purpose of explanation, the following illustration displays all indicators and warning lights illuminated.

► Instrument cluster

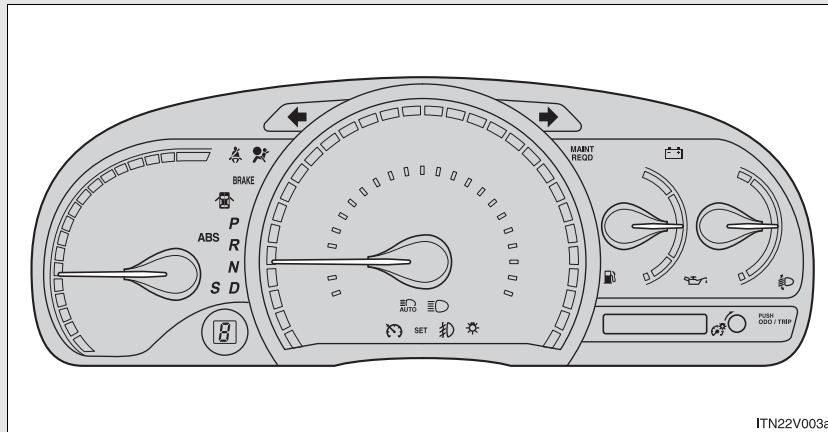

► Center display

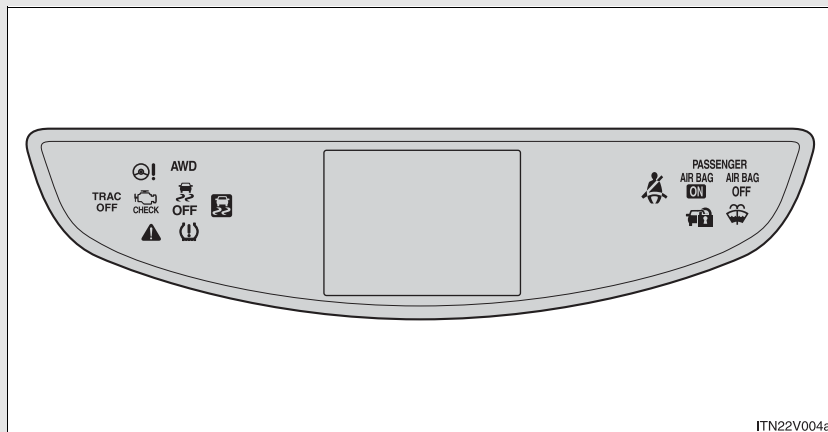

















2

When driving

■ Indicators

The indicators inform the driver of the operating state of the vehicle's various systems.

	Turn signal indicator (→P. 185)		Cruise control "SET" indicator (→P. 231)
	Headlight high beam indicator (→P. 213)	^{*1, 2} 	Slip indicator (→P. 257)
	Headlight indicator (→P. 212) (U.S.A.)	^{*1} 	VSC OFF indicator (→P. 258)
	Tail light indicator (→P. 212) (Canada)		TRAC OFF indicator (→P. 258)
	Automatic High Beam indicator (→P. 216) (if equipped)	^{*1} 	"AIR BAG ON/OFF" indicator (→P. 134)
	Fog light indicator (→P. 223)		Shift position and shift range indicators (→P. 180)
	Security indicator (→P. 109, 112)		Shift position and shift range indicators (→P. 180)
	Cruise control indicator (→P. 231)		Shift position and shift range indicators (→P. 180)
			Shift position and shift range indicators (→P. 180)

■ Warning lights

Warning lights inform the driver of malfunctions in the indicated vehicle's systems. (→P. 564)

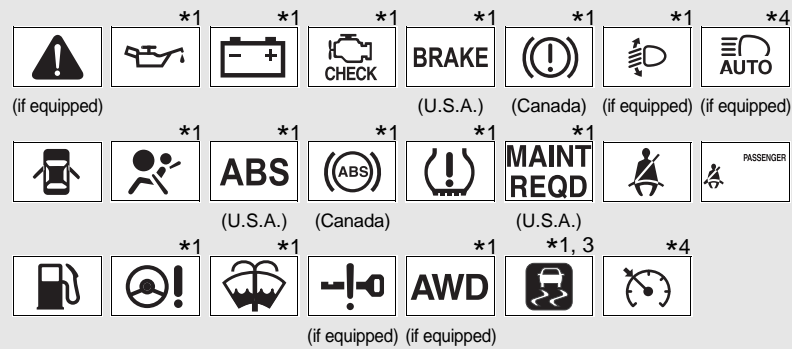

*1: These lights turn on when the “ENGINE START STOP” switch is turned to IGNITION ON mode (vehicles with smart key system) or the engine switch is turned to the “ON” position (vehicles without smart key system) to indicate that a system check is being performed. They will turn off after the engine is started, or after a few seconds. There may be a malfunction in a system if the lights do not come on, or if the lights do not turn off. Have the vehicle inspected by your Toyota dealer.

*2: The indicator flashes to indicate that the system is operating.

*3: The indicator comes on to indicate a malfunction.

*4: The indicator flashes to indicate a malfunction.

⚠ CAUTION

■ If a safety system warning light does not come on

Should a safety system light such as the ABS and the SRS airbag warning lights not come on when you start the engine, this could mean that these systems are not available to help protect you in an accident, which could result in death or serious injury. Have the vehicle inspected by your Toyota dealer immediately if this occurs.

2-2. Instrument cluster

Multi-information display (TFT type)

The multi-information display presents the driver with a variety of driving-related data, including the clock and current outside temperature.

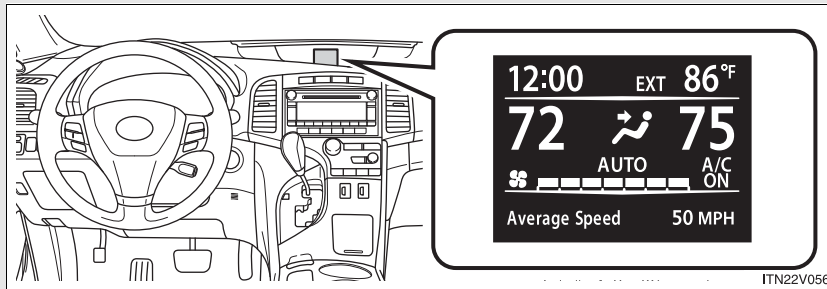

- **Clock** (→P. 199)
Indicates and sets the time.
- **Outside temperature**
Indicates the outside temperature.
The temperature range that can be displayed is from -40°F (-40°C) to 122°F (50°C).
- **Air conditioning system display** (→P. 306)
Automatically displayed when the air conditioning is turned on.
- **Trip information** (→P. 195)
Displays driving range, fuel consumption and other cruising-related information.
- **Intuitive parking assist display (if equipped)** (→P. 235)
- **Warning messages** (→P. 578)
Automatically displayed when a malfunction occurs in one of the vehicle's systems.
- **Customizable features setting display** (→P. 198, 645)

Switching the display

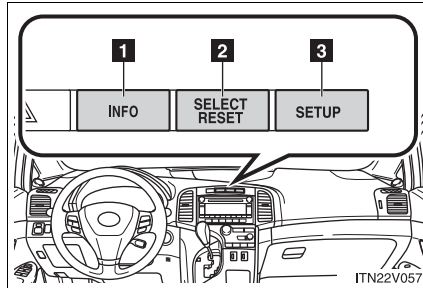

1 “INFO” button

2 “SELECT RESET” button

To reset the functions below, press the “SELECT RESET” button.

- Average Fuel Economy
- Average Speed
- Trip Timer

3 “SETUP” button

2

When driving

Trip information

Display items can be switched by pressing the “INFO” button.

■ Average Fuel Economy

Displays the average fuel consumption since the function was reset.

- The function can be reset by pressing and holding the “SELECT RESET” button when the average fuel economy is displayed.
- Use the displayed average fuel consumption as a reference.

■ Current Fuel Economy

Displays the current rate of fuel consumption.

■ **Distance to Empty**

Displays the estimated maximum distance that can be driven with the quantity of fuel remaining.

- This distance is computed based on your average fuel consumption. As a result, the actual distance that can be driven may differ from that displayed.
- When only a small amount of fuel is added to the tank, the display may not be updated. When refueling, turn the “ENGINE START STOP” switch off. If the vehicle is refueled without turning the “ENGINE START STOP” switch off, the display may not be update.

■ **Average Speed**

Displays the average vehicle speed since the function was reset.

The function can be reset by pressing and holding the “SELECT RESET” button when the average speed is displayed.

■ Trip Timer

Displays the elapsed time since the timer was reset.

The timer only functions when the engine is running. The timer can be started and paused by pressing the "SELECT RESET" button, and reset by pressing and holding the "SELECT RESET" button when the trip timer is displayed.

The display layout may be customized to show 1 line of trip information in the normal font size, 2 lines in the normal font size, or 1 line in a larger font size. (→P. 200)

When 2 lines of trip information are displayed, it is possible for both of them to be reset.

STEP 1 Press the "SELECT RESET" button.

The first display item that may be reset will be highlighted yellow.

STEP 2 Press the "SELECT RESET" button to select or reset each display item as described above.

STEP 3 Press the "SETUP" button to change which display items to reset by highlighting it in yellow.

This function only applies if both lines can be adjusted.

STEP 4 Press the "INFO" button to exit the adjusting mode.

Press the "INFO" button a second time to switch the display items.

2

When driving

Setting up the displays

STEP 1 Press the “SETUP” button while the vehicle is stopped.

The “Custom Settings” screen is displayed on the multi-information display.

If left idle for approximately 10 seconds, the display will revert to the previous screen.

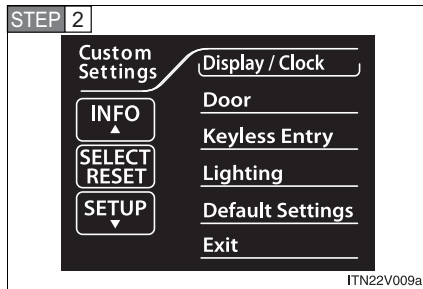

Select “Display / Clock” by pressing the “INFO” or “SETUP” button, and press the “SELECT RESET” button.

If you select “Exit” and press “SELECT RESET”, the display will revert to the previous screen.

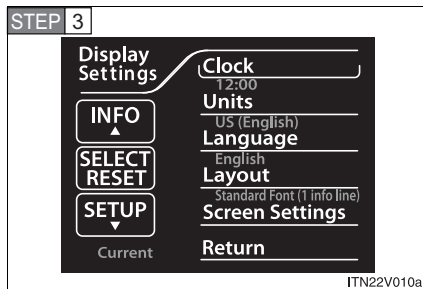

Select the desired item by pressing the “INFO” or “SETUP” button.

Press the “SELECT RESET” button to enter the setting mode.

The current setting is indicated by yellow text.

■ **Setting the clock**

STEP 1 Select “Clock” on the “Display Settings” screen, and press the “SELECT RESET” button.

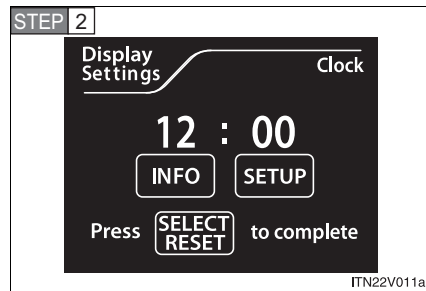

Press the “INFO” button to adjust the hours and the “SETUP” button to adjust the minutes.

Press and hold the buttons to adjust the time more quickly.

Press the “SELECT RESET” button to set the clock.

2

When driving

■ **Selecting the units**

STEP 1 Select “Units” on the “Display Settings” screen, and press the “SELECT RESET” button.

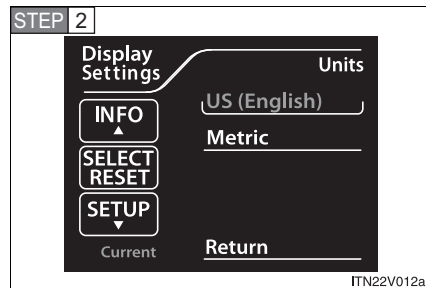

Select the units you want to read by pressing the “INFO” or “SETUP” button.

Press the “SELECT RESET” button to set the units.

The current setting is indicated by yellow text.

■ Selecting the language

STEP 1 Select “Language” on the “Display Settings” screen, and press the “SELECT RESET” button.

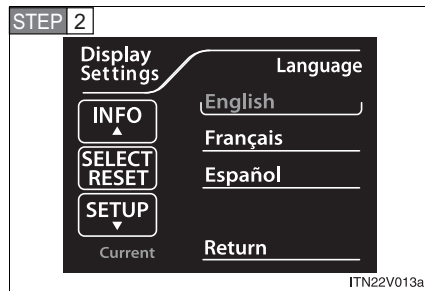

Select the language you want to read by pressing the “INFO” or “SETUP” button.

Press the “SELECT RESET” button to set the language.

The current setting is indicated by yellow text.

To shortcut directly to the “Language” screen from the initial “Custom Settings” screen, press and hold the “SETUP” button for 5 seconds.

■ Selecting the trip information layout

STEP 1 Select “Layout” on the “Display Settings” screen, and press the “SELECT RESET” button.

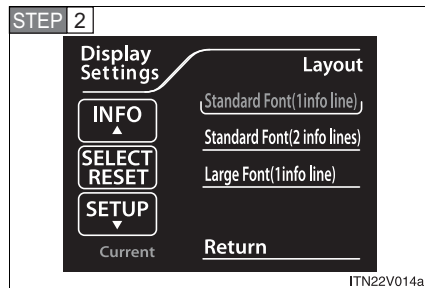

Select the desired layout by pressing the “INFO” or “SETUP” button, and press the “SELECT RESET” button.

The current setting is indicated by yellow text.

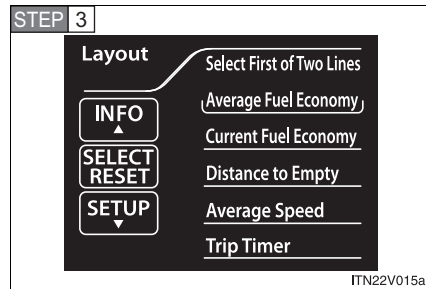

When a 2-line layout is selected in **STEP 2**, the “Layout” screen is displayed. First, using the “INFO” and “SETUP” buttons, select the item you wish to display in the first line, and then press the “SELECT RESET” button.

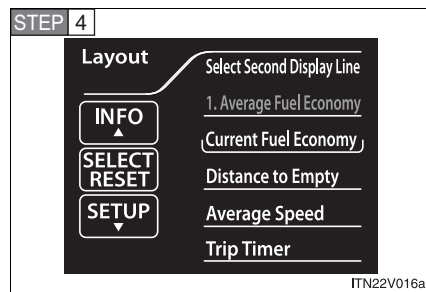

Using the “INFO” and “SETUP” buttons, select the item you wish to display in the second line, and then press the “SELECT RESET” button.

“Selection Complete” will be displayed.

2

When driving

■ Setting up the information display

Select “Screen Settings” on the “Display Settings” screen, and press the “SELECT RESET” button.

2-2. Instrument cluster

● Setting the brightness

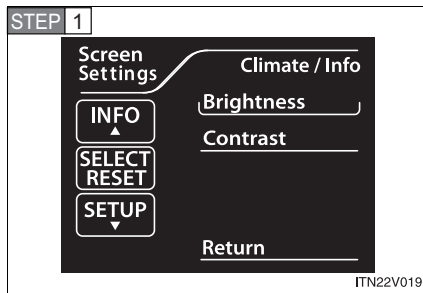

Select “Brightness” on the “Screen Settings” screen, and press the “SELECT RESET” button.

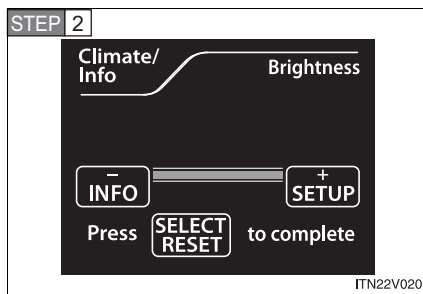

Press the “INFO” or “SETUP” button to adjust the brightness.

+: Brighter

-: Darker

Press the “SELECT RESET” button to exit screen.

● Setting the contrast

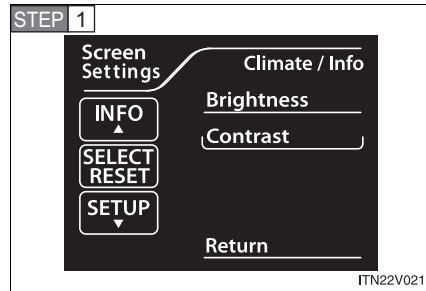

Select "Contrast" on the "Screen Settings" screen, and press the "SELECT RESET" button.

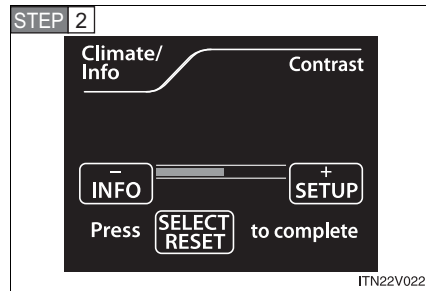

Press the "INFO" or "SETUP" button to adjust the contrast.

+: Strengthen

-: Weaken

Press the "SELECT RESET" button to exit screen.

2

When driving

■ Returning to the previous screen

Select "Return" on the "Screen Settings" screen, and press the "SELECT RESET" button.

■ **If the vehicle is moved while settings are being changed on the multi-information display**

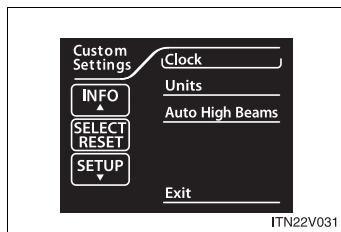

If the vehicle speed exceeds approximately 3 mph (5 km/h) while the settings are being changed, "Please Stop Vehicle to Change Settings" will be displayed on the multi-information display, and setting mode will exit after several seconds. If the "SETUP" button is pressed at a speed in excess of 3 mph (5 km/h), only some of the settings can be changed. To change the other settings, press the "SETUP" button after bringing the vehicle to a complete stop.

■ **System check display**

▶ **Vehicles with smart key system**

After switching the "ENGINE START STOP" switch to IGNITION ON mode, "VENZA" is displayed while system operation is checked. When the system check is complete, the normal screen will return.

▶ **Vehicles without smart key system**

After switching the engine switch to the "ON" position, "VENZA" is displayed while system operation is checked. When the system check is complete, the normal screen will return.

■ **When "--", "E" or "F" is displayed on the outside temperature display**

The system may be malfunctioning. Take your vehicle to your Toyota dealer.

■ **Outside temperature display**

In the following situations, the correct outside temperature may not be displayed, or the display may take longer than normal to change.

- When stopped, or driving at low speeds (less than 12 mph [20 km/h])
- When the outside temperature has changed suddenly (at the entrance/exit of a garage, tunnel, etc.)

 **NOTICE**

■ **The multi-information display at low temperatures**

Allow the interior of the vehicle to warm up before using the liquid crystal information display. At extremely low temperatures, the information display monitor may respond slowly, and display changes may be delayed.

2-2. Instrument cluster

Multi-information display (LCD type)

The multi-information display presents the driver with a variety of driving-related data, including the clock and current outside temperature.

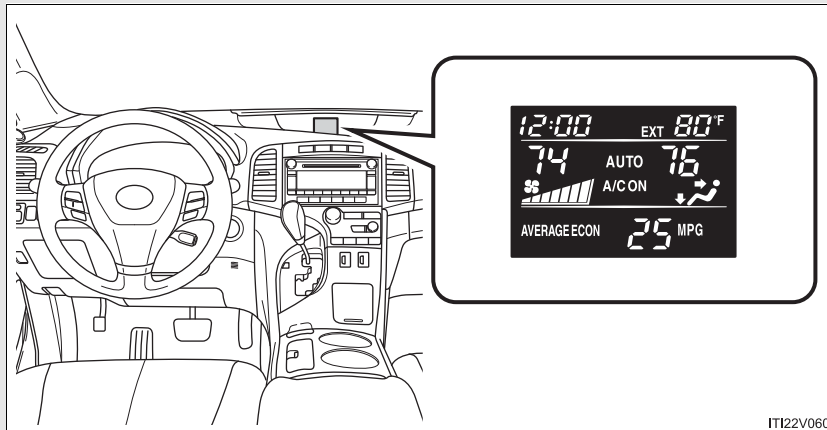

- **Clock** (→P. 208)
Indicates and sets the time.
- **Outside temperature**
Indicates the outside temperature.
The temperature range that can be displayed is from -40°F (-40°C) to 122°F (50°C).
- **Air conditioning system display** (→P. 306)
Automatically displayed when the air conditioning is turned on.
- **Trip information** (→P. 207)
Displays driving range, fuel consumption and other cruising-related information.

Switching the display

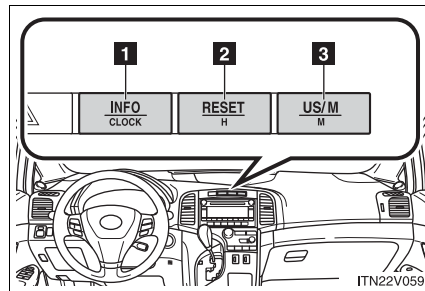

1 “INFO-CLOCK” button

2 “RESET-H” button

To reset the functions below, press the “RESET-H” button.

- Average fuel consumption
- Average vehicle speed

3 “US/M-M” button

2

When driving

Trip information

Display items can be switched by pressing the “INFO-CLOCK” button.

■ Average fuel consumption (AVERAGE ECON)

Displays the average fuel consumption since the function was reset.

- The function can be reset by pressing and holding the “RESET-H” button when the average fuel consumption is displayed.
- Use the displayed average fuel consumption as a reference.

■ Current fuel consumption (CURRENT ECON)

Displays the current rate of fuel consumption.

■ Driving range (RANGE)

Displays the estimated maximum distance that can be driven with the quantity of fuel remaining.

- This distance is computed based on your average fuel consumption. As a result, the actual distance that can be driven may differ from that displayed.
- When only a small amount of fuel is added to the tank, the display may not be updated.
When refueling, turn the “ENGINE START STOP” switch off. If the vehicle is refueled without turning the “ENGINE START STOP” switch off, the display may not be updated.

■ Average vehicle speed (AVERAGE SPEED)

Displays the average vehicle speed since the function was reset.

The function can be reset by pressing and holding the “RESET-H” button when the average vehicle speed is displayed.

Setting the clock

- STEP 1** Press and hold the “INFO-CLOCK” button until part of the display begins to flash.
- STEP 2** Press and hold the “RESET-H” button to adjust the hours and the “US/M-M” button to adjust the minutes.
- STEP 3** Press the “INFO-CLOCK” button to complete the setting.

Selecting the units

Press the “US/M-M” button.

The unit changes each time the button is pressed.

■ **Liquid crystal display**

Small spots or light spots may appear on the display. This phenomenon is characteristic of liquid crystal displays, and there is no problem to continue using the display.

■ **When "--", "E" or "F" is displayed on the outside temperature display**

The system may be malfunctioning. Take your vehicle to your Toyota dealer.

■ **Outside temperature display**

In the following situations, the correct outside temperature may not be displayed, or the display may take longer than normal to change.

- When stopped, or driving at low speeds (less than 12 mph [20 km/h])
- When the outside temperature has changed suddenly (at the entrance/exit of a garage, tunnel, etc.)

2-2. Instrument cluster

Fuel consumption information

The fuel consumption information can be displayed on Entune Premium Audio with Navigation, Entune Audio Plus and Entune Audio screen.

- ▶ Vehicles with Entune Premium Audio with Navigation and Entune Audio Plus
Press the “APPS” button, and then select “Eco” on the screen.
- ▶ Vehicles with Entune Audio
Press the “CAR” button.

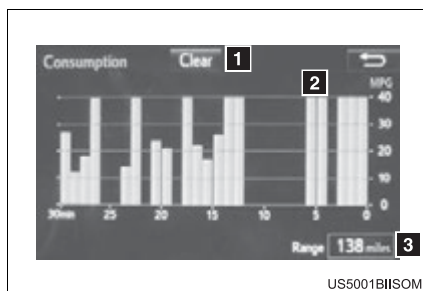

- 1 Reset the trip information data
- 2 Previous fuel consumption per minute
- 3 Cruising range

Average fuel consumption for the past 30 minutes is divided by color into past averages and averages attained since the engine switch was last turned to the “ON” position (vehicles without a smart key system) or IGNITION ON mode (vehicles with a smart key system). Use the displayed average fuel consumption as a reference.

These images are examples only, and may vary slightly from actual conditions.

■ **Resetting the data**

Selecting "Clear" will reset the trip information data.

■ **Cruising range**

Displays the estimated maximum distance that can be driven with the quantity of fuel remaining.

This distance is computed based on your average fuel consumption. As a result, the actual distance that can be driven may differ from that displayed.

2

When driving

2-3. Operating the lights and wipers Headlight switch

The headlights can be operated manually or automatically.

Turning the end of the lever turns on the lights as follows.

► Type A

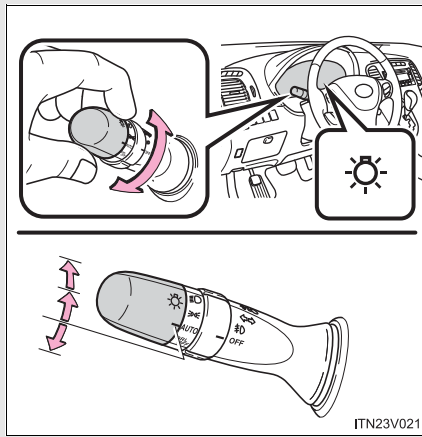

ITN23V021

► Type B

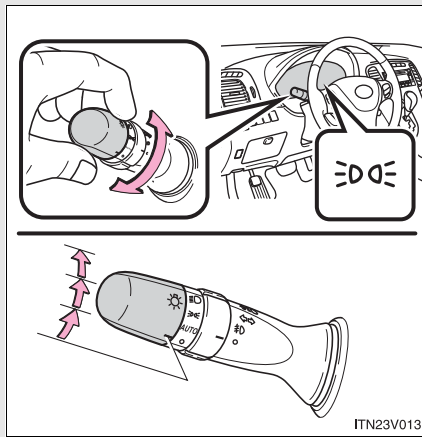

ITN23V013

 The daytime running lights turn on.

(Type B only)

AUTO The headlights, parking lights, daytime running lights and so on turn on and off automatically.

(When the “ENGINE START STOP” switch is in IGNITION ON mode [vehicles with smart key system] or the engine switch is in the “ON” position [vehicles without smart key system].)

 The side marker, parking, tail, license plate, daytime running lights and instrument panel lights turn on.

 The headlights and all lights listed above (except daytime running lights) turn on.

DRL OFF The daytime running lights turn off.

(Type A only)

Turning on the high beam headlights

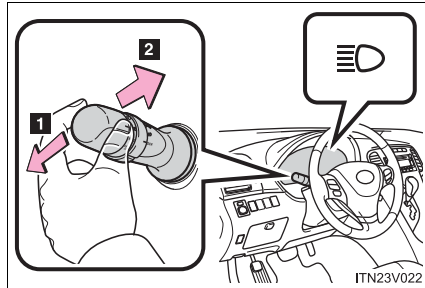

- 1 With the headlights on, push the lever forward to turn on the high beams.

Vehicles with Automatic High Beam: When the light switch is in **AUTO** position, the Automatic High Beam system will be activated. (→P. 216)

Pull the lever back to the center position to turn the high beams off.

- 2 Pull the lever toward you to turn on the high beams.

Release the lever to turn them off. You can flash the high beams with the headlights on or off.

2

When driving

■ Daytime running light system

- To make your vehicle more visible to others, the high beam headlights turn on automatically at a reduced intensity (vehicles with halogen headlights) or the LED daytime running lights turn on automatically (vehicles with discharge headlights) whenever the engine is started and the parking brake is released. Daytime running lights are not designed for use at night.

Type A: Daytime running lights can be turned off by operating the switch.

- Compared to turning on the headlights, the daytime running light system offers greater durability and consumes less electricity, so it can help improve fuel economy.

■ Headlight control sensor

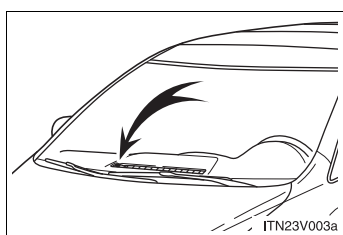

The sensor may not function properly if an object is placed on the sensor, or anything that blocks the sensor is affixed to the windshield.

Doing so interferes with the sensor detecting the level of ambient light and may cause the automatic headlight system to malfunction.

■ Automatic light off system

▶ Vehicles with smart key system



- When the headlights are on: The headlights and tail lights turn off 30 seconds after a door is opened and closed if the "ENGINE START STOP" switch has been switched to ACCESSORY or OFF mode.
- When only the tail lights are on: The tail lights turn off automatically if the "ENGINE START STOP" switch is switched to ACCESSORY or OFF mode and driver's door is opened.

To turn the lights on again, turn the "ENGINE START STOP" switch to IGNITION ON mode, or turn the light switch off once and then back to the

 or  position.

▶ Vehicles without smart key system

- When the headlights are on: The headlights and tail lights turn off 30 seconds after a door is opened and closed if the engine switch has been switched to "ACC" or "LOCK" position.
- When only the tail lights are on: The tail lights turn off automatically if the engine switch is switched to "ACC" or "LOCK" position and driver's door is opened.

To turn the lights on again, turn the engine switch to the "ON" position, or turn the light switch off once and then back to the  or  position.

■ **Automatic headlight leveling system (Vehicles with discharge headlights)**

The level of the headlights is automatically adjusted according to the number of passengers and the loading condition of the vehicle to ensure that the headlights do not interfere with other road users.

■ **Customization**

Settings (e.g. light sensor sensitivity) can be changed.
(Customizable features →P. 645)

2

When driving

 NOTICE

■ **To prevent battery discharge**

Do not leave the lights on longer than necessary when the engine is not running.

2-3. Operating the lights and wipers Automatic High Beam*

The Automatic High Beam uses an in-vehicle camera sensor to assess the brightness of streetlights, the lights of oncoming and preceding vehicles, etc., and automatically turns high beam on or off as necessary.

■ Activating the Automatic High Beam system

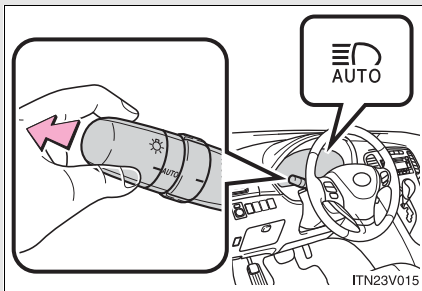

Push the lever away from you with the headlight switch in **AUTO** position when the “ENGINE START STOP” switch is in IGNITION ON mode (vehicles with smart key system) or the engine switch is in the “ON” position (vehicles without smart key system).

The Automatic High Beam indicator will come on when the headlights are turned on automatically to indicate that the system is active.

*: If equipped

■ **Turning the high beam on/off manually**

▶ **Switching to low beam**

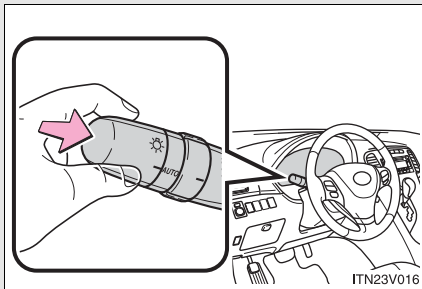

Pull the lever to original position.

▶ **Switching to high beam**

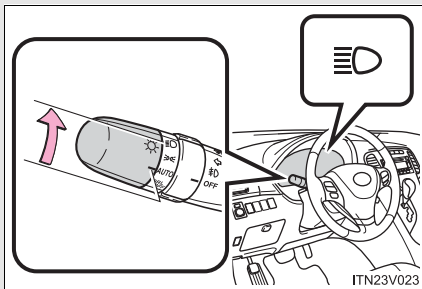

Turn the light switch to  position.

■ **High beam automatic turning on or off conditions**

When all of the following conditions are fulfilled, high beam will be automatically turned on (after approximately 1 second):

- Vehicle speed is above approximately 20 mph (32 km/h).
- The area ahead of the vehicle is dark.
- There are no oncoming or preceding vehicles with headlights or tail lights turned on.

If any of the following conditions are fulfilled, high beam will be automatically turned off:

- Vehicle speed drops below approximately 20 mph (32 km/h).
- The area ahead of the vehicle is not dark.
- Oncoming or preceding vehicles have headlights or tail lights turned on.

■ **Limitations of the Automatic High Beam**

Do not rely on the Automatic High Beam. Always drive safely, taking care to observe your surroundings and turning high beam on or off manually if necessary.

■ **Camera sensor detection information**

- High beam may not be automatically turned off in the following situations:
 - When oncoming vehicles suddenly appear from a curve.
 - When the vehicle is cut in front of by another.
- High beam may be turned off if an oncoming vehicle that is using fog lights without using the headlights is detected.
- Houselights, streetlights, red traffic signals, and illuminated billboards or signs may cause the high beam to turn off.
- The following factors may affect the amount of time taken to turn high beam on or off:
 - The brightness of headlights, fog lights, and tail lights of oncoming and preceding vehicles
 - Road conditions (wetness, ice, snow etc.)
 - The number of passengers and amount of baggage
- High beam may be turned on or off when unexpected by the driver.

2-3. Operating the lights and wipers

- In the situations below, the system may not be able to correctly detect the surrounding brightness levels, and may flash or expose nearby pedestrians to the high beam. Therefore, you should consider turning the high beam on or off manually rather than relying on the Automatic High Beam system.
 - In bad weather (rain, snow, fog, sandstorms etc.)
 - The windshield is obscured by fog, mist, ice, dirt etc.
 - The windshield is cracked or damaged.
 - The inside rear view mirror or camera sensor is deformed or dirty.
 - Surrounding brightness levels are equal to those of headlights, tail lights or fog lights.
 - Vehicles ahead have headlights that are either switched off, dirty, are changing color, or are not aimed properly.
 - When driving through an area of intermittently changing brightness and darkness
 - When frequently and repeatedly driving ascending/descending roads, or roads with rough, bumpy or uneven surfaces (such as stone-paved roads, gravel tracks etc.)
 - When frequently and repeatedly taking curves or driving on a winding road
 - There is a highly reflective object ahead of the vehicle, such as a sign or a mirror.
 - The vehicle's headlights are damaged or dirty.
 - The vehicle is listing or tilting, due to a flat tire, a trailer being towed etc.
 - The Automatic High Beam indicator is flashing.
 - The high beam and low beam are repeatedly being switched between in an abnormal manner.
 - The driver believes that the high beam may be causing problems or distress to other drivers or pedestrians nearby.

■ **If the Automatic High Beam indicator flashes...**

It may indicate a malfunction in the system. Contact your Toyota dealer.

■ **Customization**

The Automatic High Beam can be turned off.
(Customizable features →P. 645)

■ **Temporary lowering sensor sensitivity**

The sensitivity of the sensor can be temporarily lowered.

To lower the sensitivity, push and hold the “AUTO” button on the inside rear view mirror for 15 to 20 seconds, and release. The indicator light on the inside rear view mirror will flash to indicate that the sensitivity has been lowered.

Vehicles with smart key system:

When the “ENGINE START STOP” switch is turned off, the sensitivity will be returned to its normal level.

Vehicles without smart key system:

When the engine switch is turned to the “LOCK” position, the sensitivity will be returned to its normal level.

2

When driving

 NOTICE

■ Camera sensor

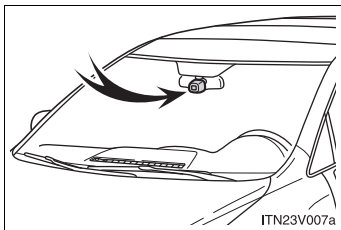

Observe the following to ensure that the Automatic High Beam functions correctly.

- Do not touch the camera sensor.
- Do not subject the inside rear view mirror or the camera sensor to a strong impact.
- Do not disassemble the camera sensor.
- Do not spill liquid onto the inside rear view mirror or the camera sensor.
- Do not apply window tinting or stickers to the camera sensor or the area of windshield near the camera sensor.
- Do not place items on the dashboard. There is a possibility that the camera sensor will mistake items reflected in the windshield for streetlights, the headlights of other vehicles, etc.
- Do not install a parking tag or any other accessories near or around the inside rear view mirror and the camera sensor.
- Do not overload the vehicle.
- Do not modify the vehicle.
- Do not replace windshield with a non-genuine windshield. Contact your Toyota dealer.

2-3. Operating the lights and wipers Fog light switch

The fog lights improve visibility in difficult driving conditions, such as in rain or fog. The fog lights can be used when the headlights are on low beam.

► Type A

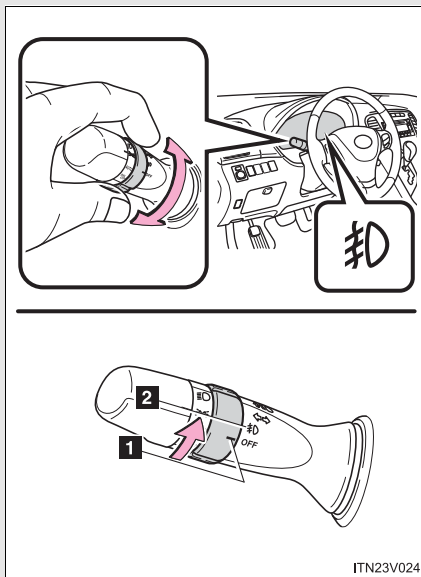

1 OFF Off

2  On

2

When driving

2-3. Operating the lights and wipers

► Type B

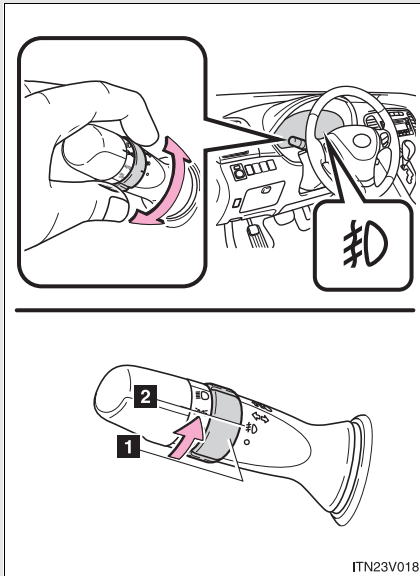

- 1 ○ Off
- 2 卐 On

ITN23V018

2-3. Operating the lights and wipers Windshield wipers and washer

Wiper intervals can be adjusted for intermittent operation (when

INT or  is selected).

► Type A

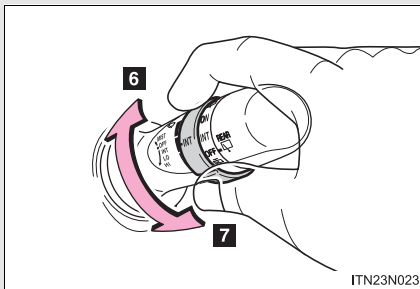
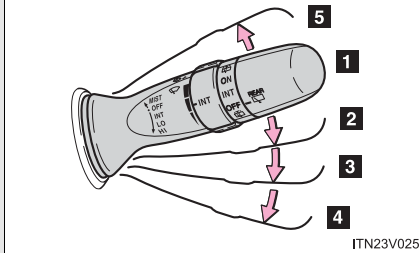
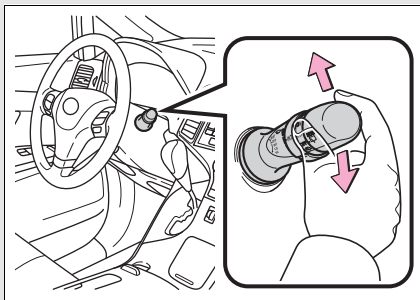

- 1** OFF Off
- 2** INT Intermittent wiper operation
- 3** LO Low speed wiper operation
- 4** HI High speed wiper operation
- 5** MIST Temporary operation

- 6** Increases the intermittent windshield wiper frequency
- 7** Decreases the intermittent windshield wiper frequency

2

When driving

2-3. Operating the lights and wipers

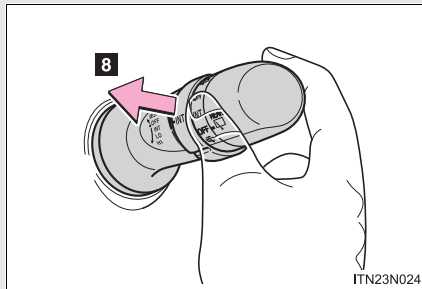



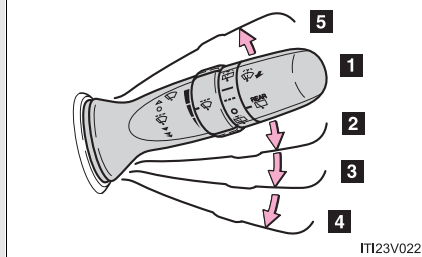
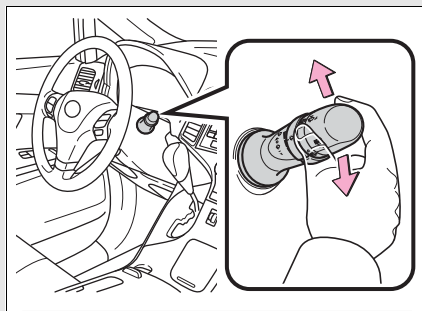

8 Wash/wipe operation

Wipers operate automatically.

► Type B



- 1  Off
- 2  Intermittent wiper operation
- 3  Low speed wiper operation
- 4  High speed wiper operation
- 5  Temporary operation

2-3. Operating the lights and wipers

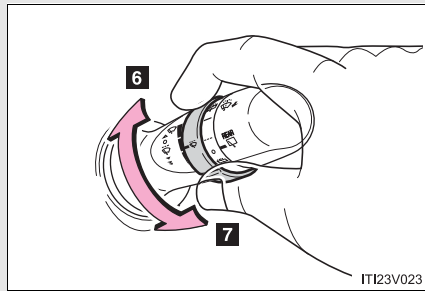

6 Increases the intermittent windshield wiper frequency

7 Decreases the intermittent windshield wiper frequency

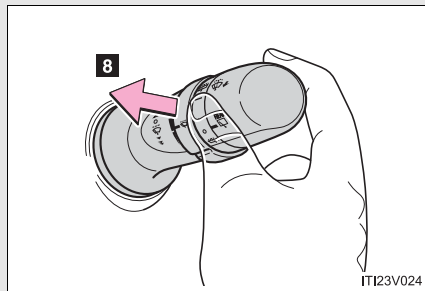

8 Wash/wipe operation

Wipers operate automatically.

2

When driving

■ **The windshield wiper and washer can be operated when**

- ▶ Vehicles with smart key system
The “ENGINE START STOP” switch is in IGNITION ON mode.
- ▶ Vehicles without smart key system
The engine switch is in the “ON” position.

■ **If no windshield washer fluid sprays**

Check that the washer nozzles are not blocked if there is washer fluid in the windshield washer fluid reservoir.

 **CAUTION**

■ **Caution regarding the use of washer fluid**

When it is cold, do not use the washer fluid until the windshield becomes warm. The fluid may freeze on the windshield and cause low visibility. This may lead to an accident, resulting in death or serious injury.

 **NOTICE**

■ **When the windshield is dry**

Do not use the wipers, as they may damage the windshield.

■ **When there is no washer fluid spray from the nozzle**

Damage to the washer fluid pump may be caused if the lever is pulled toward you and held continually.

■ **When a nozzle becomes blocked**



Do not try to clear it with a pin or other object. The nozzle will be damaged.

2-3. Operating the lights and wipers Rear window wiper and washer

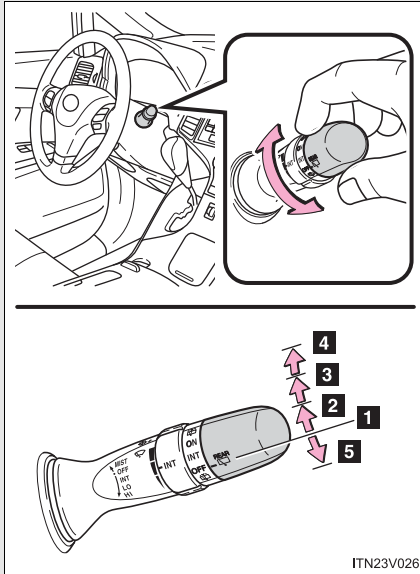
► Type A



ITN23V026

- 1** OFF Off
- 2** INT Intermittent window wiper operation
- 3** ON Normal window wiper operation
- 4**  Washer/wiper dual operation
- 5**  Washer/wiper dual operation





2

When driving

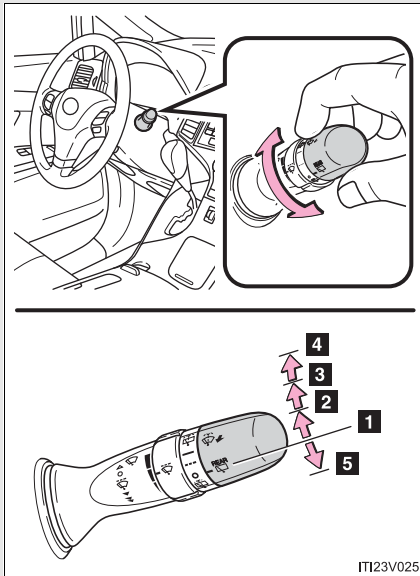
2-3. Operating the lights and wipers

► Type B



- 1  Off
- 2  Intermittent window wiper operation
- 3  Normal window wiper operation
- 4  Washer/wiper dual operation
- 5  Washer/wiper dual operation

■ The rear window wiper and washer can be operated when

- Vehicles with smart key system
The “ENGINE START STOP” switch is in IGNITION ON mode.
- Vehicles without smart key system
The engine switch is in the “ON” position.

NOTICE

■ When the rear window is dry

Do not use the wipers, as they may damage the rear window.

2-4. Using other driving systems Cruise control

Use the cruise control to maintain a set speed without depressing the accelerator pedal.

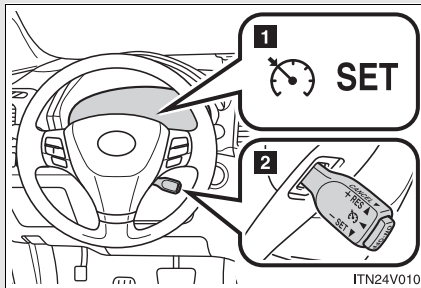

- 1 Indicators
- 2 Cruise control switch

■ Set the vehicle speed

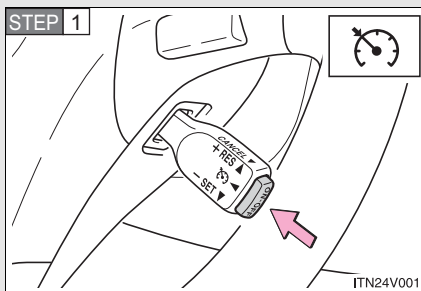

Press the “ON-OFF” button to activate the cruise control.

Cruise control indicator will come on.

Press the button again to deactivate the cruise control.

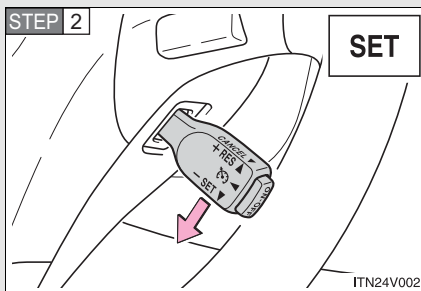

Accelerate or decelerate the vehicle to the desired speed, and push the lever down to set the speed.

Cruise control “SET” indicator will come on.

The vehicle speed at the moment the lever is released becomes the set speed.

■ Adjusting the speed setting

To change the set speed, operate the lever until the desired set speed is obtained.

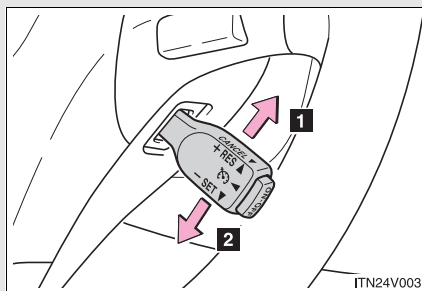

1 Increases speed

2 Decreases speed

Fine adjustment: Momentarily move the lever in the desired direction.

Large adjustment: Hold the lever in the desired direction.

The set speed will be increased or decreased as follows:

Fine adjustment: By approximately 1 mph (1.6 km/h) each time the lever is operated.

Large adjustment: The set speed can be increased or decreased continually until the lever is released.

■ **Canceling and resuming the constant speed control**

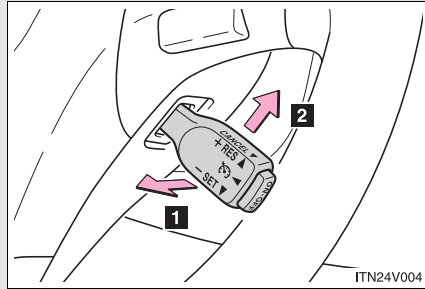

1 Pulling the lever toward you cancels the constant speed control.

The speed setting is also canceled when the brakes are applied.

2 Pushing the lever up resumes the constant speed control.

Resuming is available when the vehicle speed is more than approximately 25 mph (40 km/h).

2

When driving

■ **Cruise control can be set when**

- The shift lever is in D or range 4 or higher of S has been selected.
- Vehicle speed is above approximately 25 mph (40 km/h).

■ **Accelerating after setting the vehicle speed**

- The vehicle can be accelerated normally. After acceleration, the set speed resumes.
- Even without canceling the cruise control, the set speed can be increased by first accelerating the vehicle to the desired speed and then pushing the lever down to set the new speed.

2-4. Using other driving systems

■ Automatic cruise control cancelation

Cruise control will stop maintaining the vehicle speed in any of the following situations.

- Actual vehicle speed falls more than approximately 10 mph (16 km/h) below the preset vehicle speed.
At this time, the memorized set speed is not retained.
- Actual vehicle speed is below approximately 25 mph (40 km/h).
- VSC is activated.

■ If the cruise control indicator light flashes

Press the “ON-OFF” button once to deactivate the system, and then press the button again to reactivate the system.

If the cruise control speed cannot be set or if the cruise control cancels immediately after being activated, there may be a malfunction in the cruise control system. Have the vehicle inspected by your Toyota dealer.

CAUTION

■ To avoid operating the cruise control by mistake

Switch the cruise control off using the “ON-OFF” button when not in use.

■ Situations unsuitable for cruise control

Do not use cruise control in any of the following situations.

Doing so may result in loss of control and could cause an accident resulting in death or serious injury.

- In heavy traffic
- On roads with sharp bends
- On winding roads
- On slippery roads, such as those covered with rain, ice or snow
- On steep hills
Vehicle speed may exceed the set speed when driving down a steep hill.
- When your vehicle is towing a trailer or during emergency towing

2-4. Using other driving systems Intuitive parking assist*

The distance from your vehicle to nearby obstacles when parallel parking or maneuvering into a garage is measured by the sensors and communicated via the multi-information display, the audio system screen and a buzzer. Always check the surrounding area when using this system.

■ Types of sensors

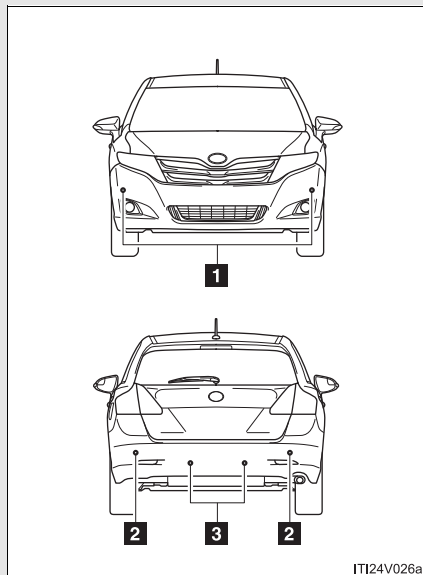

1 Front corner sensors

2 Rear corner sensors

3 Back sensors

■ Intuitive parking assist switch

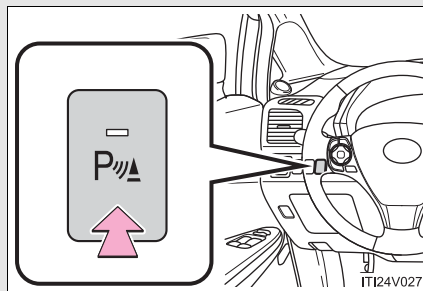

Turns intuitive parking assist on/off

When on, the indicator light comes on to inform the driver that the system is operational.

*: If equipped

Display

When the sensors detect an obstacle, the following displays inform the driver of the position and distance to the obstacle.

► Multi-information display

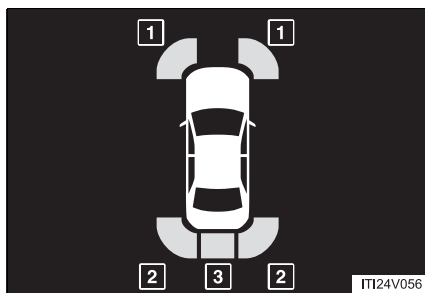

- 1 Front corner sensor operation
- 2 Rear corner sensor operation
- 3 Back sensor operation

► Audio system screen (vehicles with an Entune Premium Audio with Navigation)



When the rear view monitor system is not displayed.

A graphic is automatically displayed when an obstacle is detected. The screen can be set so that the graphic is not displayed. (→P. 240)

The distance display and buzzer

When a sensor detects an obstacle, the direction of and the approximate distance to the obstacle are displayed and the buzzer sounds.

■ **Corner sensor operation and distance to an obstacle**

The system operates when the vehicle approaches within the following distances to an obstacle. The indicator flashes and the buzzer sounds when the system is operating.

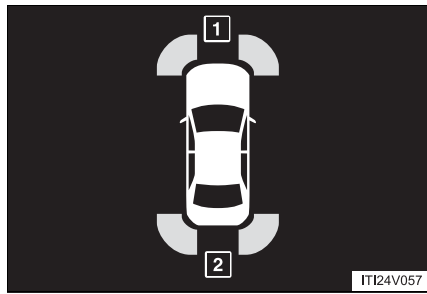

1 Front

Approximate distance to obstacle	Indicator and buzzer / Color
1.6 to 1.3 ft. (50 to 40 cm)	Intermittent / yellow
1.3 to 1.0 ft. (40 to 30 cm)	Fast intermittent / yellow
1.0 ft. (30 cm) or less	Continuous / red

2 Rear

Approximate distance to obstacle	Indicator and buzzer / Color
2.0 to 1.5 ft. (60 to 45 cm)	Intermittent / yellow
1.5 to 1.0 ft. (45 to 30 cm)	Fast intermittent / yellow
1.0 ft. (30 cm) or less	Continuous / red

2

When driving

2-4. Using other driving systems

■ Back sensor operation and distance to an obstacle

The system operates when the vehicle approaches within the following distances to an obstacle. The indicator flashes and the buzzer sounds when the system is operating.

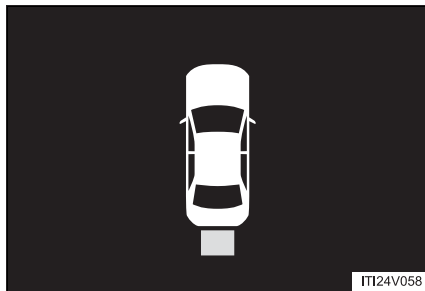

Approximate distance to obstacle	Indicator and buzzer / Color
4.9 to 2.0 ft. (150 to 60 cm)	Slow intermittent / yellow
2.0 to 1.5 ft. (60 to 45 cm)	Intermittent / yellow
1.5 to 1.1 ft. (45 to 35 cm)	Fast intermittent / yellow
1.1 ft. (35 cm) or less	Continuous / red

Detection range of the sensors

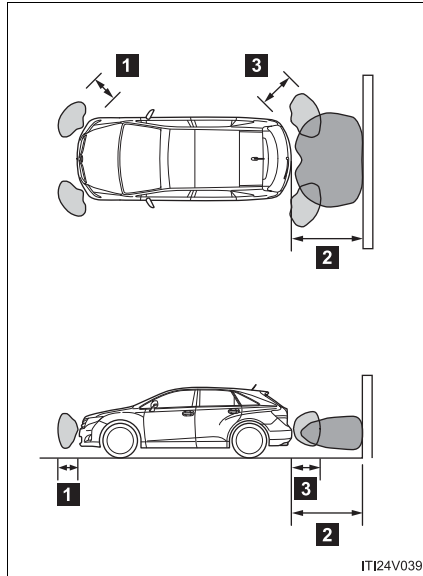

- 1** Approximately 1.6 ft. (50 cm)
- 2** Approximately 4.9 ft. (150 cm)
- 3** Approximately 2.0 ft. (60 cm)

The diagram shows the detection range of the sensors. Note that the sensors cannot detect obstacles that are extremely close to the vehicle.

The range of the sensors may change depending on the shape of the object etc.

2

When driving

Setting up intuitive parking assist (vehicles with an Entune Premium Audio with Navigation)

You can change the buzzer sound volume and the screen operating conditions.

STEP 1 Press the “APPS” button.

STEP 2 Select “Setup” on the screen.

STEP 3 Select “Vehicle” on the screen.

STEP 4 Select “TOYOTA Park Assist Settings” on the screen.

STEP 5 Select the desired item.



1 The buzzer sound volume can be adjusted.

2 On or off can be selected for intuitive parking assist display.

■ Sensor detection information

- Certain vehicle conditions and the surrounding environment may affect the ability of the sensor to correctly detect obstacles. Particular instances where this may occur are listed below.
 - There is dirt, snow or ice on the sensor.
 - A sensor is frozen.
 - A sensor is covered in any way.
 - The vehicle is leaning considerably to one side.
 - On an extremely bumpy road, on an incline, on gravel, or on grass.
 - The vicinity of the vehicle is noisy due to vehicle horns, motorcycle engines, air brakes of large vehicles, or other loud noises producing ultrasonic waves.
 - There is another vehicle equipped with parking assist sensors in the vicinity.
 - The sensor is coated with a sheet of spray or heavy rain.
 - The vehicle is equipped with a fender pole or wireless antenna.
 - The bumper or sensor receives a strong impact.
 - The vehicle is approaching a tall or curved curb.
 - In harsh sunlight or intense cold weather.
 - A non-genuine Toyota suspension (lowered suspension etc.) is installed.

In addition to the examples above, there are instances in which, because of their shapes, signs and other objects may be judged by the sensor to be closer than they are.

- The shape of the obstacle may prevent the sensor from detecting it. Pay particular attention to the following obstacles:
 - Wires, fences, ropes, etc.
 - Cotton, snow and other materials that absorb sound waves
 - Sharply-angled objects
 - Low obstacles
 - Tall obstacles with upper sections projecting outwards in the direction of your vehicle

■ If the display flashes and a message is displayed

→P. 578

2-4. Using other driving systems

■ Certification (Canada only)

This ISM device complies with Canadian ICES-001.

CAUTION

■ When using the intuitive parking assist

Observe the following precautions.

Failing to do so may result in the vehicle being unable to be driven safely and possibly cause an accident.

- Do not use the sensor at speeds in excess of 6 mph (10 km/h).
- Do not attach any accessories within the sensor range.

NOTICE

■ Notes when washing the vehicle

Do not apply intensive bursts of water or steam to the sensor area.
Doing so may result in the sensor malfunctioning.

2-4. Using other driving systems Rear view monitor system*

The rear view monitor system assists the driver by displaying guide lines and an image of the view behind the vehicle while backing up, for example while parking.

The screen illustrations used in this text are intended as examples, and may differ from the image that is actually displayed on the screen.

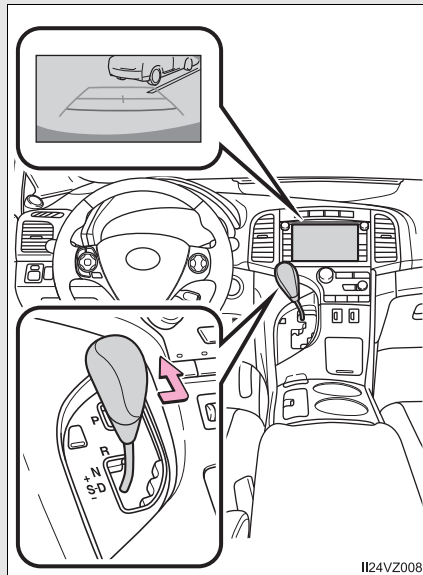

Vehicles with smart key system: The rear view image is displayed when the shift lever is in "R" and the "ENGINE START STOP" switch is in IGNITION ON mode.

Vehicles without smart key system: The rear view image is displayed when the shift lever is in "R" and the engine switch is in the "ON" position.

If you move the lever out of "R", the rear view monitor system will be deactivated.

2

When driving

*: If equipped

2-4. Using other driving systems

Screen description

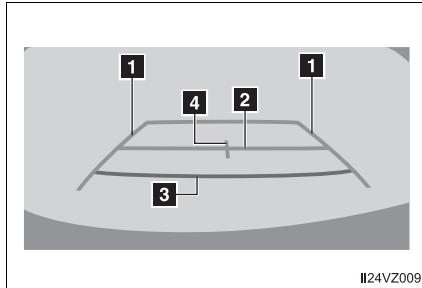

Guide lines are displayed on the screen.

Guide lines shown differ from those shown on the actual screen.

1 Vehicle width extension guide lines (blue)

The line indicates a guide path when the vehicle is being backed straight up.

The displayed width is wider than the actual vehicle width.

2 Distance guide line (blue)

This line indicates a position on the ground about 3 ft. (1 m) behind on the ground of the rear bumper of your vehicle.

3 Distance guide line (red)

This line indicates a position on the ground about 1.5 ft. (0.5 m) behind on the ground of the rear bumper of your vehicle.

4 Vehicle center guide lines (blue)

These lines indicate the estimated vehicle center on the ground.

Rear view monitor system precautions

■ Area displayed on screen

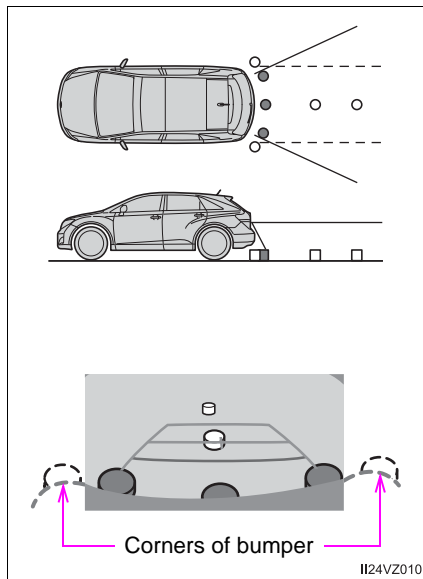

The rear view monitor system displays an image of the view from the bumper of the rear area of the vehicle.

The image on the rear view monitor system can be adjusted: refer to P. 333.

- The area displayed on the screen may vary according to vehicle orientation conditions.
- Objects which are close to either corner of the bumper or under the bumper cannot be displayed.
- The camera uses a special lens. The distance of the image that appears on the screen differs from the actual distance.
- Items which are located higher than the camera may not be displayed on the monitor.
- If your vehicle is equipped with a backlit license plate, it may interfere with the display.

2

When driving

2-4. Using other driving systems

■ Rear view monitor system camera

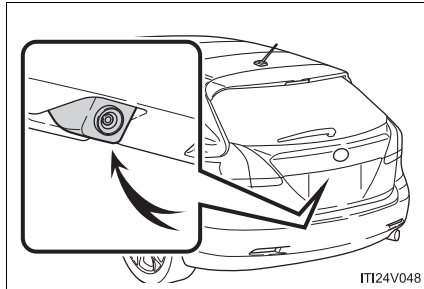

The camera for the rear view monitor system is located above the license plate.

● Using the camera

If dirt or foreign matter (such as water droplets, snow, mud etc.) is adhering to the camera, it cannot transmit a clear image. In this case, flush it with a large quantity of water. After that, rinse the camera lens with water and wipe it clean with a soft and wet cloth.

■ Differences between the screen and the actual road

The distance guide lines and the vehicle width extension guide lines may not actually be parallel with the dividing lines of the parking space, even when they appear to be so. Be sure to check visually.

The distances between the vehicle width extension guide lines and the left and right dividing lines of the parking space may not be equal, even when they appear to be so. Be sure to check visually.

The distance guide lines give a distance guide for flat road surfaces. In any of the following situations, there is a margin of error between the guide lines on the screen and the actual distance/course on the road.

● When the ground behind the vehicle slopes up sharply

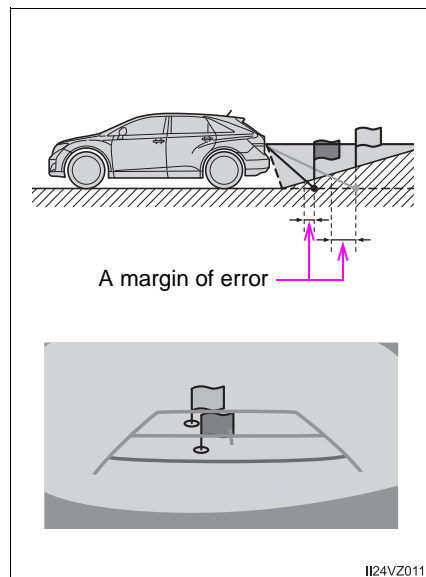

The distance guide lines will appear to be closer to the vehicle than the actual distance. Because of this, objects will appear to be farther away than they actually are. In the same way, there will be a margin of error between the guide lines and the actual distance/course on the road.

2-4. Using other driving systems

● When the ground behind the vehicle slopes down sharply

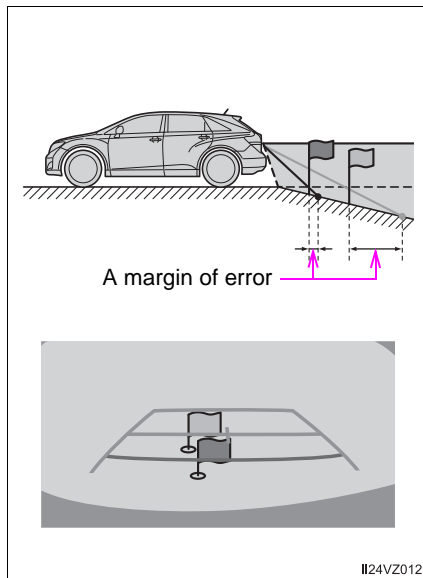

The distance guide lines will appear to be farther from the vehicle than the actual distance. Because of this, objects will appear to be closer than they actually are. In the same way, there will be a margin of error between the guide lines and the actual distance/course on the road.

● When any part of the vehicle sags

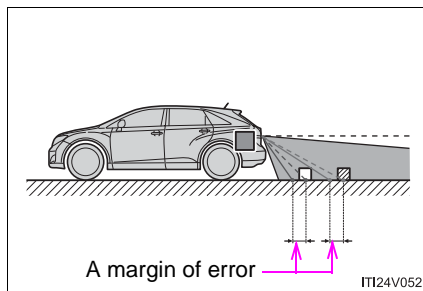

When any part of the vehicle sags due to the number of passengers or the distribution of the load, there is a margin of error between the guide lines on the screen and the actual distance/course on the road.

■ **When approaching three-dimensional objects**

It is not possible to determine the position of three-dimensional objects (such as vehicles) using the vehicle width extension guide lines and distance guide lines. When approaching a three-dimensional object that extends outward (such as the flatbed of a truck), be careful of the following.

● **Vehicle width extension guide lines**

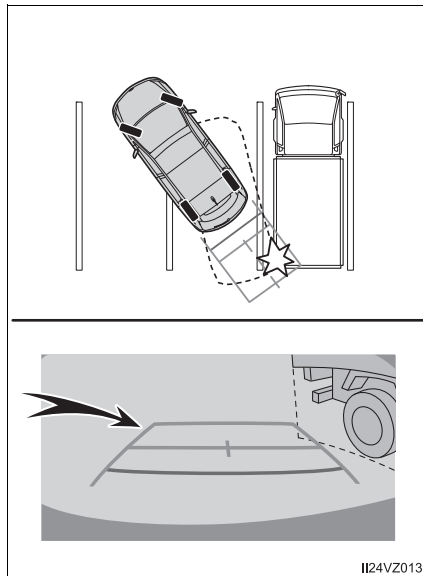

Visually check the surroundings and the area behind the vehicle. In the case shown in the illustration, the truck appears to be outside of the vehicle width extension guide lines and the vehicle does not look as if it hits the truck. However, the rear body of the truck may actually cross over the vehicle width extension guide lines. In reality if you back up as guided by the vehicle width extension guide lines, the vehicle may hit the truck.

2
When driving

2-4. Using other driving systems

● Distance guide lines

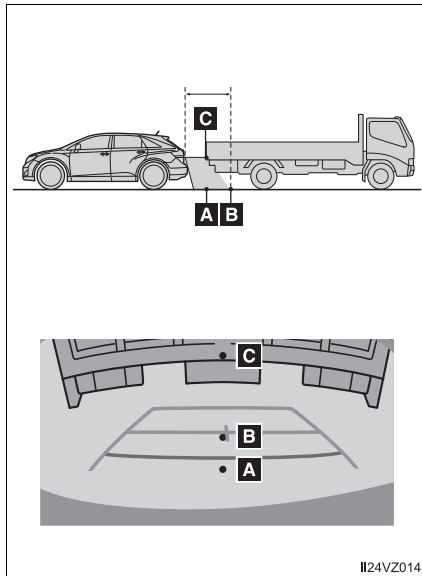

Visually check the surroundings and the area behind the vehicle. On the screen, it appears that a truck is parking at point B. However, in reality if you back up to point A, you will hit the truck. On the screen, it appears that A is closest and C is furthest away. However, in reality, the distance to A and C is the same, and B is farther than A and C.

Things you should know

■ If you notice any symptoms

If you notice any of the following symptoms, refer to the likely cause and the solution, and re-check.

If the symptom is not resolved by the solution, have the vehicle inspected by your Toyota dealer.

Symptom	Likely cause	Solution
The image is difficult to see	<ul style="list-style-type: none"> • The vehicle is in a dark area • The temperature around the lens is either high or low • The outside temperature is low • There are water droplets on the camera • It is raining or humid • Foreign matter (mud etc.) is adhering to the camera • There are scratches on the camera • Sunlight or headlights are shining directly into the camera • The vehicle is under fluorescent lights, sodium lights, mercury lights etc. 	If this happens due to these causes, it does not indicate a malfunction. Back up while visually checking the vehicle's surroundings. (Use the monitor again once conditions have been improved.)
The image is blurry	Dirt or foreign matter (such as water droplets, snow, mud etc.) is adhering to the camera.	Flush the camera with a large quantity of water. After that, rinse the camera lens with water and wipe it clean with a soft and wet cloth.
The image is out of alignment	The camera or surrounding area has received a strong impact.	Have the vehicle inspected by your Toyota dealer.

2-4. Using other driving systems

Symptom	Likely cause	Solution
The guide lines are very far out of alignment	The camera position is out of alignment.	Have the vehicle inspected by your Toyota dealer.
	<ul style="list-style-type: none">• The vehicle is tilted (there is a heavy load on the vehicle, tire pressure is low due to a tire puncture, etc.)• The vehicle is used on an incline.	If this happens due to these causes, it does not indicate a malfunction. Back up while visually checking the vehicle's surroundings.

⚠ CAUTION**■ When using the rear view monitor system**

The rear view monitor system is a supplemental device intended to assist the driver when backing up. When backing up, be sure to check visually behind and all around the vehicle before proceeding.

Observe the following precautions to avoid an accident that could result in death or serious injuries.

- Never depend on the rear view monitor system entirely when backing up. The image and the position of the guide lines displayed on the screen may differ from the actual state. Use caution, just as you would when backing up any vehicle.
- Be sure to back up slowly, depressing the brake pedal to control vehicle speed.
- When and how much to turn the steering wheel will vary according to traffic conditions, road surface conditions, vehicle condition, etc. when parking. It is necessary to be fully aware of this before using the rear view monitor system.
- When parking, be sure to check that the parking space will accommodate your vehicle before maneuvering into it.
- Do not use the rear view monitor system in the following cases:
 - On icy or slick road surfaces, or in snow
 - When using tire chains or the compact spare tire
 - When the back door is not closed completely
 - On roads that are not flat or straight, such as curves or slopes.

2

When driving

2-4. Using other driving systems

CAUTION

- In low temperatures, the screen may darken or the image may become faint. The image could distort when the vehicle is moving, or you may become unable to see the image on the screen. Be sure to check direct visually and with the mirrors all around the vehicle before proceeding.
- If the tire sizes are changed, the position of the guide lines displayed on the screen may change.
- The camera uses a special lens. The distances between objects and pedestrians that appear in the image displayed on the screen will differ from the actual distances. (→P. 247)

 NOTICE

■ **How to use the camera**

- The rear view monitor system may not operate properly in the following cases.
 - If the back of the vehicle is hit, the position and mounting angle of the camera may change.
 - As the camera has a water proof construction, do not detach, disassemble or modify it. This may cause incorrect operation.
 - When cleaning the camera lens, flush the camera with a large quantity of water, rinse the camera lens with water and wipe it with a soft and wet cloth. Failure to do so may cause the camera lens to be scratched and unable to transmit a clear image.
 - Do not allow organic solvent, car wax, window cleaner or glass coat to adhere to the camera. If this happens, wipe it off as soon as possible.
 - If the temperature changes rapidly, such as when hot water is poured on the vehicle in cold weather, the system may not operate normally.
 - When washing the vehicle, do not apply intensive bursts of water to the camera or camera area. Doing so may result in the camera malfunctioning.
- Do not expose the camera to strong impact as this could cause a malfunction. If this happens, have the vehicle inspected by your Toyota dealer as soon as possible.

2-4. Using other driving systems

Driving assist systems

To help enhance driving safety and performance, the following systems operate automatically in response to various driving situations. Be aware, however, that these systems are supplementary and should not be relied upon too heavily when operating the vehicle.

■ **ABS (Anti-lock Brake System)**

Helps to prevent wheel lock when the brakes are applied suddenly, or if the brakes are applied while driving on a slippery road surface.

■ **Brake assist**

Generates an increased level of braking force after the brake pedal is depressed, when the system detects a panic stop situation.

■ **VSC (Vehicle Stability Control)**

Helps the driver to control skidding when swerving suddenly or turning on slippery road surfaces

■ **TRAC (Traction Control)**

Maintains drive power and prevent the front wheels (2WD models) or four wheels (AWD models) from spinning when starting the vehicle or accelerating on slippery roads.

■ **EPS (Electric Power Steering)**

Employs an electric motor to reduce the amount of effort needed to turn the steering wheel.

■ **Enhanced VSC (Enhanced Vehicle Stability Control)**

Provides cooperative control of the ABS, TRAC, VSC and EPS. Helps to maintain directional stability when swerving on slippery road surfaces by controlling steering performance.

■ **Hill-start assist control**

→P. 262

■ **Active Torque Control 4WD (if equipped)**

Automatically switches from front-wheel drive to AWD (All-Wheel Drive) according to driving conditions, helping to ensure reliable handling and stability. Examples of conditions where the system will switch to AWD are when cornering, going uphill, starting off or accelerating, and when the road surface is slippery due to snow or rain etc.

2

When the TRAC/VSC system are operating

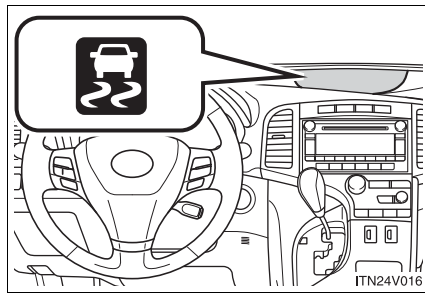

The slip indicator light will flash while the TRAC/VSC systems are operating.

When driving

Disabling the TRAC system

If the vehicle gets stuck in mud, dirt or snow, the TRAC system may reduce power from the engine to the wheels. Pressing  to turn the system off may make it easier for you to rock the vehicle in order to free it.

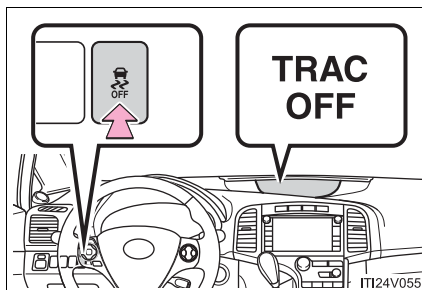



To turn the TRAC system off, quickly press and release

The TRAC OFF indicator light will come on.

Push  again to turn the system back on.

■ Turning off both TRAC and VSC system

To turn the TRAC and VSC systems off, press and hold  for more than 3 seconds while the vehicle is stopped.

- The TRAC OFF indicator light and VSC OFF indicator light will come on.
- Press  again to turn the systems back on.

■ **When the “TRAC OFF” indicator light comes on even if the VSC OFF switch has not been pressed**

TRAC and hill-start assist control cannot be operated. Contact your Toyota dealer.

■ **Automatic reactivation of TRAC and VSC**

After turning the TRAC and VSC systems off, the systems will be automatically re-enabled in the following situations:

- When the “ENGINE START STOP” switch is turned off (vehicles with smart key system)
- When the engine switch is turned to the “LOCK” position (vehicles without smart key system)
- If only the TRAC system is turned off, the TRAC will turn on when vehicle speed increases
If both the TRAC and VSC systems are turned off, automatic re-enabling will not occur when vehicle speed increases.

■ **Sounds and vibrations caused by the ABS, brake assist, TRAC and VSC**

- A sound may be heard from the engine compartment when the engine is started or just after the vehicle begins to move. This sound does not indicate that a malfunction has occurred in any of these systems.
- Any of the following conditions may occur when the above systems are operating. None of these indicates that a malfunction has occurred.
 - Vibrations may be felt through the vehicle body and steering.
 - A motor sound may be heard after the vehicle comes to a stop.
 - The brake pedal may pulsate slightly after the ABS is activated.
 - The brake pedal may move down slightly after the ABS is activated.

2-4. Using other driving systems

■ EPS operation sound

When the steering wheel is operated, a motor sound (whirring sound) may be heard.

This does not indicate a malfunction.

■ Reduced effectiveness of EPS system

The effectiveness of EPS system is reduced to prevent the system from overheating when there is frequent steering input over an extended period of time. The steering wheel may feel heavy as a result. Should this occur, refrain from excessive steering input or stop the vehicle and turn the engine off. The EPS system should return to normal within 10 minutes.

CAUTION

■ The ABS does not operate effectively when

- The limits of tire gripping performance have been exceeded.
- The vehicle hydroplanes while driving at high speed on the wet or slick road.

■ Stopping distance when the ABS is operating may exceed that of normal conditions

The ABS is not designed to shorten the vehicle's stopping distance. Always maintain a safe distance from the vehicle in front of you in the following situations.

- When driving on dirt, gravel or snow-covered roads
- When driving with tire chains
- When driving over bumps in the road
- When driving over roads with potholes or roads with uneven roads

■ TRAC may not operate effectively when

Directional control and power may not be achievable while driving on slippery road surfaces, even if the TRAC is operating.

Drive the vehicle carefully in conditions where stability and power may be lost.

⚠ CAUTION**■ When TRAC and VSC are off**

Be especially careful and drive at a speed appropriate to the road conditions. As there are systems to help ensure vehicle stability and driving force, do not turn off TRAC and VSC unless necessary.

■ When the VSC is activated

The slip indicator light flashes. Always drive carefully.

Reckless driving may cause an accident. Exercise particular care when the indicator light flashes.

■ Replacing tires

Make sure that all tires are of the same size, brand, tread pattern and total load capacity. In addition, make sure that the tires are inflated to the specified tire pressure level.

The ABS and VSC will not function correctly if different tires are fitted on the vehicle.

Contact your Toyota dealer for further information when replacing tires or wheels.

■ Handling of tires and suspension

Using tires with any kind of problem or modifying the suspension will affect the driving assist systems, and may cause the system to malfunction.

■ Active Torque Control 4WD system

- The AWD system of this vehicle is intended to ensure driving stability on normal roads. It is not designed for use in demanding situations such as rally driving.

- Take care when driving on slippery road surfaces.

2-4. Using other driving systems Hill-start assist control

Hill-start assist control helps to prevent the vehicle from rolling backwards when starting on incline or slippery slope.

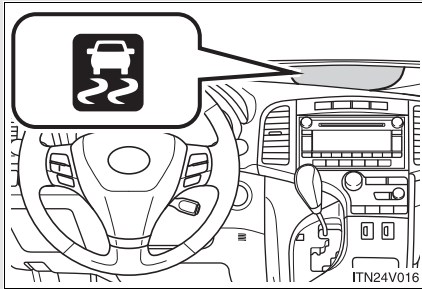

To engage hill-start assist control, further depress the brake pedal when the vehicle is stopped completely.

A buzzer will sound once to indicate the system is activated. The slip indicator will also start flashing.

■ Hill-start assist control operating conditions

The system operates in the following situations:

- The shift lever is in a position other than "P".
- The parking brake is not applied.
- The accelerator pedal is not depressed.

■ Hill-start assist control

- While hill-start assist control is operating, the brakes remain automatically applied after the driver releases the brake pedal. The stop lights and the high mounted stoplight turn on.
- Hill-start assist control operates for about 2 seconds after the brake pedal is released.
- If the slip indicator does not flash and the buzzer does not sound when the brake pedal is further depressed, slightly reduce the pressure on the brake pedal (do not allow the vehicle to roll backward) and then firmly depress it again. If the system still does not operate, check that the operating conditions explained above have been met.

■ **Hill-start assist control buzzer**

- When hill-start assist control is activated, the buzzer will sound once.
- In the following situations, hill-start assist control will be canceled and the buzzer will sound twice.
 - No attempt is made to drive the vehicle within approximately 2 seconds of releasing the brake pedal.
 - The shift lever is moved to “P”.
 - The parking brake is applied.
 - The brake pedal is depressed again.

■ **If the slip indicator comes on...**

It may indicate a malfunction in the system. Contact your Toyota dealer.

 **CAUTION**

■ **Hill-start assist control**

- Do not overly rely on hill-start assist control. Hill-start assist control may not operate effectively on extremely steep inclines or roads covered in ice.
- Unlike the parking brake, hill-start assist control is not intended to hold the vehicle stationary for an extended period of time. Do not attempt to use hill-start assist control to hold the vehicle on an incline for an extended period of time, as doing so may lead to an accident.

2-5. Driving information

Utility vehicle precautions

This vehicle belongs to the utility vehicle class, which has higher ground clearance and narrower tread in relation to the height of its center of gravity.

Utility vehicle feature

- Specific design characteristics give it a higher center of gravity than ordinary passenger cars. This vehicle design feature causes this type of vehicle to be more likely to rollover. And, utility vehicles have a significantly higher rollover rate than other types of vehicles.
- It is not designed for cornering at the same speeds as ordinary passenger cars any more than low-slung sports cars are designed to perform satisfactorily under off-road conditions. Therefore, sharp turns at excessive speeds may cause rollover.

 CAUTION**Utility vehicle precautions**

Always observe the following precautions to help minimize the risk of serious personal injury or damage to your vehicle:

- In a rollover crash, an unbelted person is significantly more likely to die than a person wearing a seat belt. Therefore, the driver and all passengers should fasten their seat belts whenever the vehicle is moving.
- Avoid sharp turns or abrupt maneuvers, if at all possible.
Failure to operate this vehicle correctly may result in loss of control or vehicle rollover causing death or serious injury.
- Loading cargo on the roof luggage carrier will make the center of the vehicle gravity higher. Avoid high speeds, sudden starts, sharp turns, sudden braking or abrupt maneuvers, otherwise it may result in loss of control or vehicle rollover due to failure to operate this vehicle correctly and result in death or serious injury.
- Always slow down in gusty crosswinds. Because of its profile and higher center of gravity, your vehicle is more sensitive to side winds than an ordinary passenger car. Slowing down will allow you to have better control.
- Do not drive horizontally across steep slopes. Driving straight up or straight down is preferred. Your vehicle (or any similar off-road vehicle) can tip over sideways much more easily than forward or backward.

Off-road driving

Your vehicle is not designed to be driven off-road. However, in the event that off-road driving cannot be avoided, please observe the following precautions to help avoid the areas prohibited to vehicles.

- Drive your vehicle only in areas where off-road vehicles are permitted to travel.
- Respect private property. Get owner's permission before entering private property.
- Do not enter areas that are closed. Honor gates, barriers and signs that restrict travel.
- Stay on established roads. When conditions are wet, driving techniques should be changed or travel delayed to prevent damage to roads.

■ Additional information for off-road driving

- ▶ For owners in U.S. mainland, Hawaii and Puerto Rico:

To obtain additional information pertaining to driving your vehicle off-road, consult the following organizations.

- State and Local Parks and Recreation Departments
- State Motor Vehicle Bureau
- Recreational Vehicle Clubs
- U.S. Forest Service and Bureau of Land Management

⚠ CAUTION**■ Off-road driving precautions**

Always observe the following precautions to help minimize the risk of serious personal injury or damage to your vehicle:

- Drive carefully when off the road. Do not take unnecessary risks by driving in dangerous places.
- Do not grip the steering wheel spokes when driving off-road. A bad bump could jerk the wheel and injure your hands. Keep both hands and especially your thumbs on the outside of the rim.
- Always check your brakes for effectiveness immediately after driving in sand, mud, water or snow.
- After driving through tall grass, mud, rock, sand, rivers, etc., check that there is no grass, bush, paper, rags, stone, sand, etc. adhering or trapped on the underbody. Clear off any such matter from the underbody. If the vehicle is used with these materials trapped or adhering to the underbody, a breakdown or fire could occur.
- When driving off-road or in rugged terrain, do not drive at excessive speeds, jump, make sharp turns, strike objects, etc. This may cause loss of control or vehicle rollover causing death or serious injury. You are also risking expensive damage to your vehicle's suspension and chassis.

2

When driving

 NOTICE

■ **To prevent the water damage**

Take all necessary safety measures to ensure that water damage to the engine or other components does not occur.

- Water entering the engine air intake will cause severe engine damage.
- Water entering the automatic transmission will cause deterioration in shift quality, locking up of your transmission accompanied by vibration, and ultimately damage.
- Water can wash the grease from wheel bearings, causing rusting and premature failure, and may also enter the differentials, transmission and transfer case, reducing the gear oil's lubricating qualities.

■ **When you drive through water**

If driving through water, such as when crossing shallow streams, first check the depth of the water and the bottom of the river bed for firmness. Drive slowly and avoid deep water.

■ **Inspection after off-road driving**

- Sand and mud that has accumulated in brake drums and around brake discs may affect braking efficiency and may damage brake system components.
- Always perform a maintenance inspection after each day of off-road driving that has taken you through rough terrain, sand, mud, or water. For scheduled maintenance information, refer to the "Scheduled Maintenance Guide" or "Owner's Manual Supplement".

2-5. Driving information

Cargo and luggage

Take notice of the following information about storage precautions, cargo capacity and load.

- Stow cargo and luggage in the luggage compartment whenever possible. Be sure all items are secured in place.
- Be careful to keep the vehicle level. Placing the weight as far forward as possible helps maintain vehicle balance.
- For better fuel economy, do not carry unnecessary weight.

2

When driving

Capacity and distribution

Cargo capacity depends on the total weight of the occupants.

(Cargo capacity) = (Total load capacity) — (Total weight of occupants)

Steps for Determining Correct Load Limit—

- (1) Locate the statement “The combined weight of occupants and cargo should never exceed XXX kg or XXX lbs.” on your vehicle’s placard.
- (2) Determine the combined weight of the driver and passengers that will be riding in your vehicle.
- (3) Subtract the combined weight of the driver and passengers from XXX kg or XXX lbs.
- (4) The resulting figure equals the available amount of cargo and luggage load capacity.

For example, if the “XXX” amount equals 1400 lbs. and there will be five 150 lb passengers in your vehicle, the amount of available cargo and luggage load capacity is 650 lbs. (1400 - 750 (5 × 150) = 650 lbs.)

- (5) Determine the combined weight of luggage and cargo being loaded on the vehicle.

That weight may not safely exceed the available cargo and luggage load capacity calculated in Step 4.

- (6) If your vehicle will be towing a trailer, load from your trailer will be transferred to your vehicle. Consult this manual to determine how this reduces the available cargo and luggage load capacity of your vehicle. (→P. 274)

Calculation formula for your vehicle

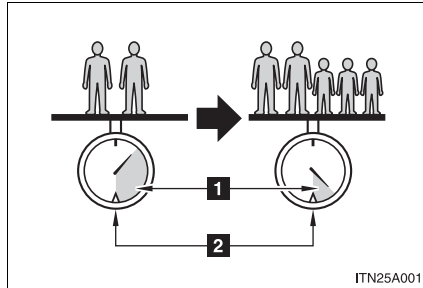

- 1** Cargo capacity
- 2** Total load capacity (vehicle capacity weight) (→P. 612)

2

When driving

When 2 people with the combined weight of A lb. (kg) are riding in your vehicle, which has a total load capacity (vehicle capacity weight) of B lb. (kg), the available amount of cargo and luggage load capacity will be C lb. (kg) as follows:

$$B^{*2} \text{ lb. (kg)} - A^{*1} \text{ lb. (kg)} = C^{*3} \text{ lb. (kg)}$$

*1: A = Weight of people

*2: B = Total load capacity

*3: C = Available cargo and luggage load

In this condition, if 3 more passengers with the combined weight of D lb. (kg) get on, the available cargo and luggage load will be reduced E lb. (kg) as follows:

$$C \text{ lb. (kg)} - D^{*4} \text{ lb. (kg)} = E^{*5} \text{ lb. (kg)}$$

*4: D = Additional weight of people

*5: E = Available cargo and luggage load

As shown in the example above, if the number of occupants increases, the cargo and luggage load will be reduced by an amount that equals the increased weight due to the additional occupants. In other words, if an increase in the number of occupants causes an excess of the total load capacity (combined weight of occupants plus cargo and luggage load), you must reduce the cargo and luggage on your vehicle.

 CAUTION

■ **Things that must not be carried in the luggage compartment**

The following things may cause a fire if loaded in the luggage compartment.

- Receptacles containing gasoline
- Aerosol cans

■ **Storage precautions**

Observe the following precautions.

Failing to do so may result in death or serious injury.

- Do not place cargo or luggage in or on the following locations as the item may get under the brake or accelerator pedal and prevent the pedals from being depressed properly, block the driver's vision, or hit the driver or passengers, causing an accident.
 - Driver's feet
 - Front passenger or rear seats (when stacking items)
 - Luggage cover
 - Instrument panel
 - Dashboard
 - Auxiliary box or tray that has no lid
- Secure all items in the occupant compartment, as they may shift and injure someone during sudden braking, sudden swerving or an accident.
- Never allow anyone to ride in the luggage compartment. It is not designed for passengers. They should ride in their seats with their seat belts properly fastened. Otherwise, they are much more likely to suffer death or serious injury, in the event of sudden braking, sudden swerving or an accident.

 CAUTION

■ **Weight of the load**

- Do not exceed the maximum axle weight rating or the total vehicle weight rating.
- Even if the total load of occupant's weight and the cargo load is less than the total load capacity, do not apply the load unevenly. Improper loading may cause deterioration of steering or braking control which may cause death or serious injury.

2

When driving

2-5. Driving information

Vehicle load limits

Vehicle load limits include total load capacity, seating capacity, Trailer Weight Rating (TWR) and cargo capacity.

■ **Total load capacity (vehicle capacity weight): →P. 612**

Total load capacity means the combined weight of occupants, cargo and luggage.

■ **Seating capacity: 5 occupants (Front 2, Rear 3)**

Seating capacity means the maximum number of occupants whose estimated average weight is 150 lb. (68 kg) per person. Even if the number of occupants is within the seating capacity, do not exceed the total load capacity.

■ **Trailer Weight Rating (TWR): →P. 288, 612**

Trailer Weight Rating (TWR) means the maximum gross trailer weight (trailer weight plus its cargo weight) that your vehicle is able to tow.

■ **Cargo capacity**

Cargo capacity may increase or decrease depending on the weight and the number of occupants.

■ **Total load capacity and seating capacity**

These details are also described on the tire and loading information label. (→P. 513)

 **CAUTION**

■ **Overloading the vehicle**

Do not overload the vehicle.
It may not only cause damage to the tires, but also degrade steering and braking ability, resulting in an accident.

2

When driving

2-5. Driving information

Winter driving tips

Carry out the necessary preparations and inspections before driving the vehicle in winter. Always drive the vehicle in a manner appropriate to the prevailing weather conditions.

■ Pre-winter preparations

- Use fluids that are appropriate to the prevailing outside temperatures.
 - Engine oil
 - Engine coolant
 - Washer fluid
- Have a service technician inspect the condition of the battery.
- Have the vehicle fitted with four snow tires or purchase a set of tire chains for the front tires (do not fit tire chains on to the rear tires).

Ensure that all tires are the same size and brand, and that chains match the size of the tires.

■ **Before driving the vehicle**

Perform the following according to the driving conditions.

- Do not try to forcibly open a window or move a wiper that is frozen. Pour warm water over the frozen area to melt the ice. Wipe away the water immediately to prevent it from freezing.
- To ensure proper operation of the climate control system fan, remove any snow that has accumulated on the air inlet vents in front of the windshield.
- Check for and remove any excess ice or snow that may have accumulated on the exterior lights, vehicle's roof, chassis, around the tires or on the brakes.
- Remove any snow or mud from the bottom of your shoes before getting in the vehicle.

■ **When driving the vehicle**

Accelerate the vehicle slowly, keep a safe distance between you and the vehicle ahead, and drive at a reduced speed suitable to road conditions.

■ **When parking the vehicle**

Park the vehicle and move the shift lever to "P" without setting the parking brake. The parking brake may freeze up, preventing it from being released. If necessary block the wheels to prevent inadvertent sliding or creeping.

Selection tire chains

Use the correct tire chain size when mounting the tire chains.
Chain size is regulated for each tire size.

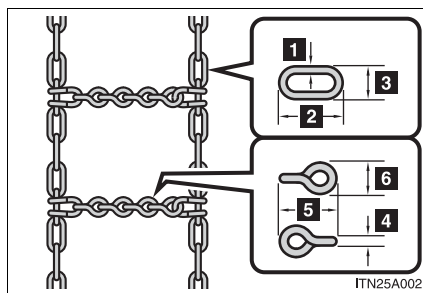

Side chain:

- 1 0.12 in. (3.0 mm)
- 2 1.18 in. (30.0 mm)
- 3 0.39 in. (10.0 mm)

Cross chain:

- 4 0.16 in. (4.0 mm)
- 5 0.98 in. (25.0 mm)
- 6 0.55 in. (14.0 mm)

Regulations on the use of tire chains

- Regulations regarding the use of tire chains vary according to location and type of road. Always check local regulations before installing chains.
- Retighten the chains after driving 1/4 - 1/2 mile (0.5 - 1.0 km).

■ Tire chains

Observe the following precautions when installing and removing chains.

- Install and remove tire chains in a safe location.
- Install tire chains on the front tires only. Do not install tire chains on the rear tires.
- Install tire chains following the instructions provided in the accompanying manual.

⚠ CAUTION**■ Driving with snow tires**

Observe the following precautions to reduce the risk of accidents. Failing to do so may result in a loss of vehicle control and cause death or serious injury.

- Use tires of the size specified for your vehicle.
- Maintain the recommended level of tire inflation pressure.
- Do not drive in excess of 75 mph (120 km/h), regardless of the type of snow tires being used.
- Snow tires should be installed on all wheels.

■ Driving with tire chains

Observe the following precautions to reduce the risk of accidents. Failing to do so may result in the vehicle being unable to be driven safely, and may cause death or serious injury.

- Do not drive in excess of the speed limit specified for the tire chains being used, or 30 mph (50 km/h), whichever is lower.
- Avoid driving on bumpy road surfaces or over potholes.
- Avoid sudden acceleration, abrupt steering, sudden braking and shifting operations that cause sudden engine braking.
- Slow down sufficiently before entering a curve to ensure that vehicle control is maintained.

 NOTICE

■ **Repairing or replacing snow tires**

Request repairs of and obtain replacement snow tires from Toyota dealers or legitimate tire retailers.

This is because the removal and attachment of snow tires affects the operation of the tire pressure warning valves and transmitters.

■ **Fitting tire chains**

The tire pressure warning valves and transmitters may not function correctly when tire chains are fitted.

2-5. Driving information

Trailer towing

Your vehicle is designed primarily as a passenger-and-load-carrying vehicle. Towing a trailer can have an adverse impact on handling, performance, braking, durability, and fuel consumption. For your safety and the safety of others, you must not overload your vehicle or trailer. You must also ensure that you are using appropriate towing equipment, that the towing equipment has been installed correctly and used properly, and that you employ the requisite driving habits.

Vehicle-trailer stability and braking performance are affected by trailer stability, brake performance and setting, trailer brakes, the hitch and hitch systems (if equipped).

To tow a trailer safely, use extreme care and drive the vehicle in accordance with your trailer's characteristics and operating conditions.

Toyota warranties do not apply to damage or malfunction caused by towing a trailer for commercial purposes.

Contact your Toyota dealer for further information about additional requirements such as a towing kit, etc.

2

When driving

Towing related terms

■ GCWR (Gross Combination Weight Rating)

- ▶ 2GR-FE engine (Without towing package) and 1AR-FE engine

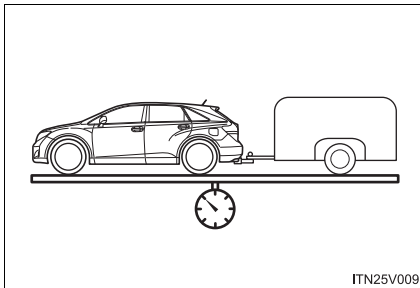

The maximum allowable gross combination weight. The gross combination weight is the sum of the total vehicle weight (including the occupants, cargo and any optional equipment installed on the vehicle) and the weight of the trailer being towed (including the cargo in the trailer).

- ▶ 2GR-FE engine (With towing package)

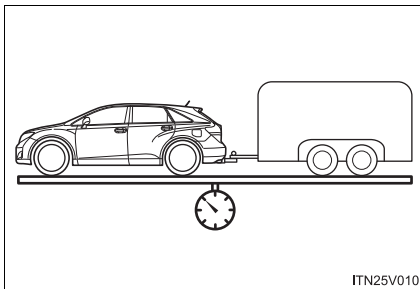

■ **GVWR (Gross Vehicle Weight Rating)**

- ▶ 2GR-FE engine (Without towing package) and 1AR-FE engine

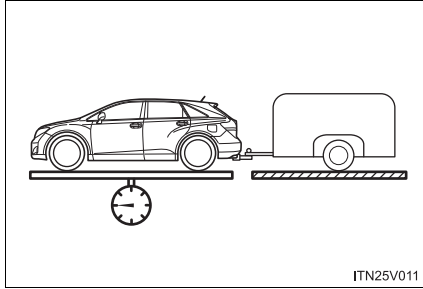

The maximum allowable gross vehicle weight. The gross vehicle weight is the total weight of the vehicle. When towing a trailer, it is the sum of the vehicle weight (including the occupants, cargo and any optional equipment installed on the vehicle) and the tongue weight.

- ▶ 2GR-FE engine (With towing package)

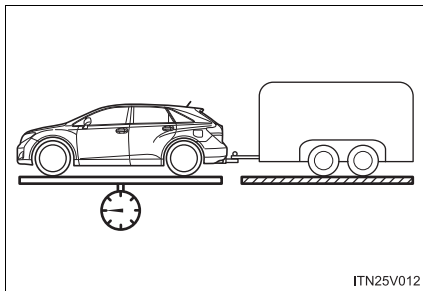

■ **GAWR (Gross Axle Weight Rating)**

- ▶ 2GR-FE engine (Without towing package) and 1AR-FE engine

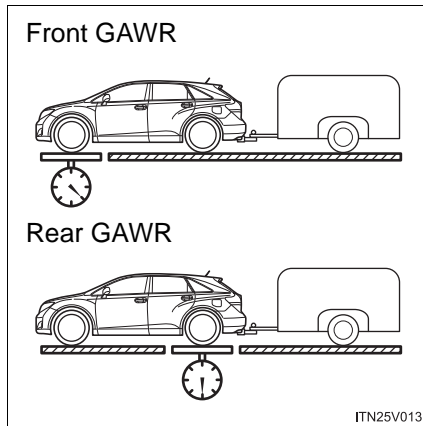

The maximum allowable gross axle weight. The gross axle weight is the load placed on each axle (front and rear).

- ▶ 2GR-FE engine (With towing package)

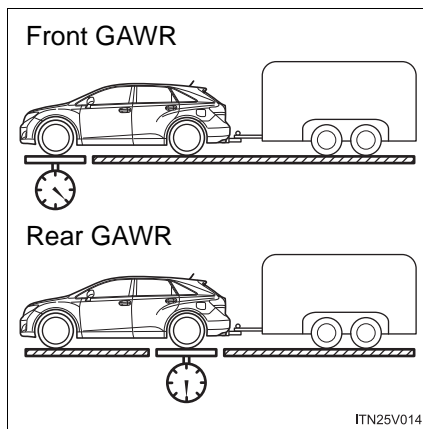

■ **TWR (Trailer Weight Rating)**

- ▶ 2GR-FE engine (Without towing package) and 1AR-FE engine

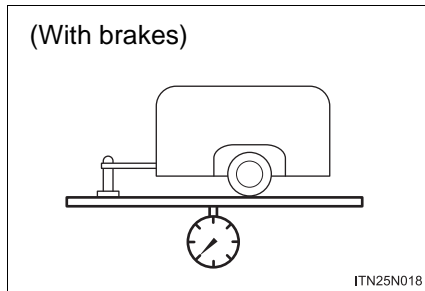

The maximum allowable gross trailer weight. The gross trailer weight is the sum of the trailer weight and the weight of the cargo in the trailer.

TWR is calculated assuming base vehicle with one driver, one front passenger, towing package (if available), hitch and hitch systems (if required).

Additional optional equipment, passengers and cargo in the vehicle will reduce the trailer weight rating so as not to exceed GCWR, GVWR and GAWR.

2GR-FE engine (With towing package): If the gross trailer weight exceeds 3000 lb. (1360 kg), it is recommended to use a trailer with 2 or more axles.

- ▶ 2GR-FE engine (With towing package)

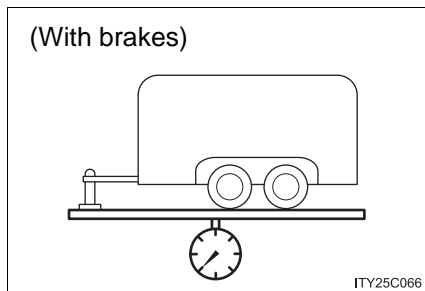

■ **Unbraked TWR (Unbraked Trailer Weight Rating)**

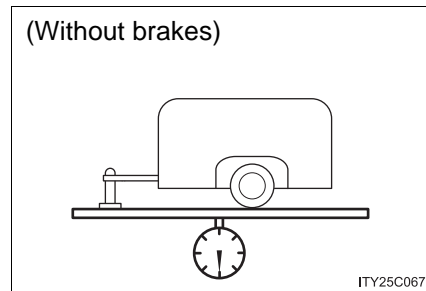

The trailer weight rating for towing a trailer without a trailer service brake system.

■ **Tongue Weight**

- ▶ 2GR-FE engine (Without towing package) and 1AR-FE engine

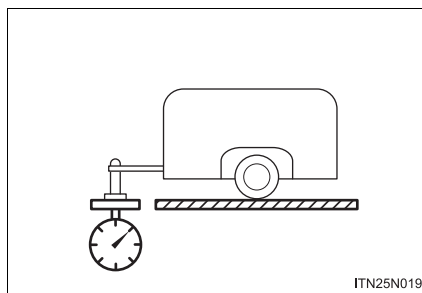

The load placed on the trailer hitch ball. (→P. 289)

- ▶ 2GR-FE engine (With towing package)

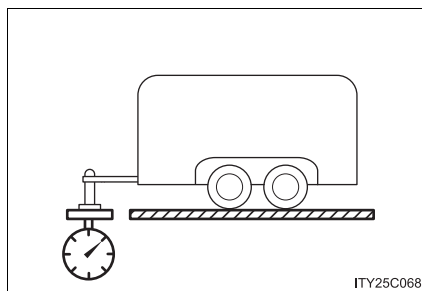

Weight limits

- The gross trailer weight must never exceed TWR described in the table. (→P. 288)
- The gross combination weight must never exceed the GCWR described in the table. (→P. 288)

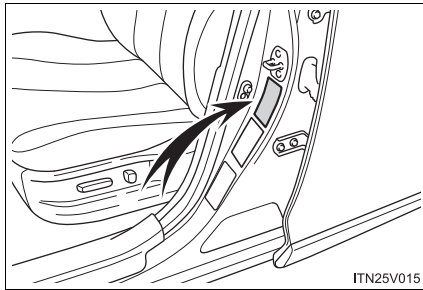

- The gross vehicle weight must never exceed the GVWR indicated on the Certification Label.
- The gross axle weight on each axle must never exceed the GAWR indicated on the Certification Label.

- If the gross trailer weight is over the unbraked TWR, trailer service brakes are required.
- Vehicles with a towing package: If the gross trailer weight is over 2000 lbs. (907 kg), a sway control device with sufficient capacity is required.

2

When driving

GCWR, TWR and Unbraked TWR

Confirm that the gross trailer weight, gross combination weight, gross vehicle weight, gross axle weight and tongue weight are all within the limits.

■ **GCWR* and TWR***

▶ Vehicles without towing package

Engine	Driving system	GCWR	TWR
1AR-FE engine	2WD	5960 lb. (2700 kg)	1000 lb. (450 kg)
	AWD	6160 lb. (2790 kg)	
2GR-FE engine	2WD	6095 lb. (2760 kg)	
	AWD	6270 lb. (2840 kg)	

▶ Vehicles with towing package

Engine	Driving system	GCWR	TWR
1AR-FE engine	2WD	7460 lb. (3385 kg)	2500 lb. (1135 kg)
	AWD	7660 lb. (3475 kg)	
2GR-FE engine	2WD	8595 lb. (3895 kg)	3500 lb. (1585 kg)
	AWD	8770 lb. (3975 kg)	

■ **Unbraked TWR***

1000 lb. (450kg)

*: These models meet the tow-vehicle trailering requirement of SAE International per SAE J2807.

Trailer Tongue Weight

- A recommended tongue weight varies in accordance with the types of trailers or towing as described below.
- To ensure the recommended values shown below, the trailer must be loaded by referring to the following instructions.

- Tongue Weight

The gross trailer weight should be distributed so that the tongue weight is 9 to 11%.

(Tongue weight / Gross trailer weight × 100 = 9 to 11%)

- ▶ 2GR-FE engine (Without towing package) and 1AR-FE engine

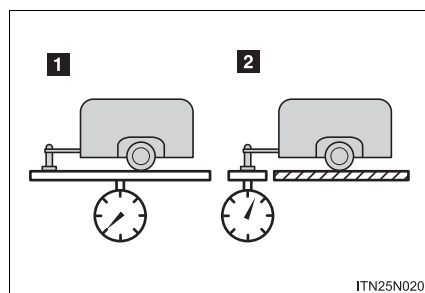

- 1** Gross trailer weight
- 2** Tongue weight

- ▶ 2GR-FE engine (With towing package)

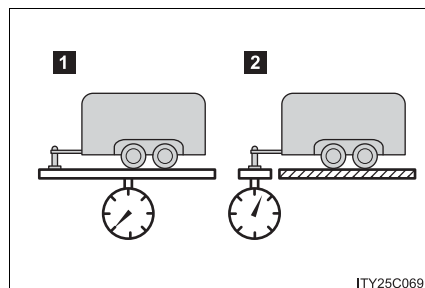

2-5. Driving information

If using a weight distributing hitch when towing, return the front axle to the same weight as before the trailer connection.

If front axle weight cannot be measured directly, measure the front fender height above the front axle before connection. Adjust weight distributing hitch torque until front fender is returned to the same height as before connection.

The gross trailer weight, gross axle weight and tongue weight can be measured with platform scales found at a highway weighing station, building supply company, trucking company, junk yard, etc.

Hitch

Trailer hitch assemblies have different weight capacities. Toyota recommends the use of Toyota hitch/bracket for your vehicle. For details, contact your Toyota dealer.

- If you wish to install a trailer hitch, contact your Toyota dealer.
- Use only a hitch that conforms to the gross trailer weight requirement of your vehicle.
- Follow the directions supplied by the hitch manufacturer.
- Lubricate the hitch ball with a light coating of grease.
- Remove the trailer hitch whenever you are not towing a trailer. After removing the hitch, seal any mounting hole in the vehicle body to prevent entry of any substances into the vehicle.

Selecting trailer ball

Use the correct trailer ball for your application.

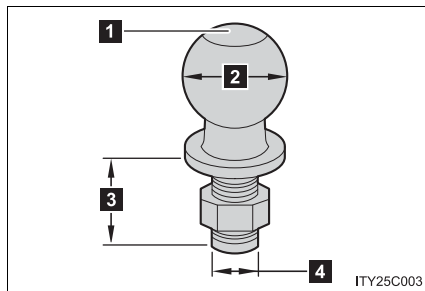

1 Trailer ball load rating

Matches or exceeds the gross trailer weight rating of the trailer.

2 Ball diameter

Matches the size of the trailer coupler. Most couplers are stamped with the required trailer ball size.

2

When driving

Trailer class	Typical trailer ball size
IV	2 5/16 in.
II and III	2 in.
I	1 7/8 in.

3 Shank length

Protrudes beyond the bottom of the lock washer and nut at least 2 threads.

4 Shank diameter

Matches the ball mount hole diameter size.

Positions for towing hitch receiver and hitch ball

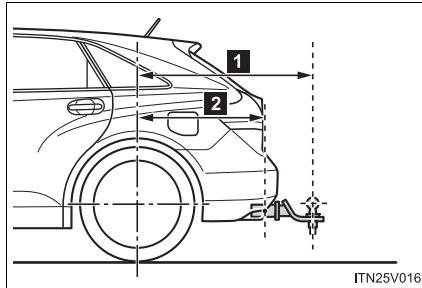

- 1** Weight carrying ball position:
46.5 in. (1180 mm)
- 2** Hitch receiver pin hole position:
39.2 in. (996.5 mm)

Connecting trailer lights

Please consult your dealer when installing trailer lights, as incorrect installation may cause damage to the vehicle's lights. Please take care to comply with your state's laws when installing trailer lights.

Trailer towing tips

Your vehicle will handle differently when towing a trailer. Help to avoid an accident, death or serious injury, keep the following in mind when towing:

- Speed limits for towing a trailer vary by state or province. Do not exceed the posted towing speed limit.
- Toyota recommends that the vehicle-trailer speed limit is 65 mph (104 km/h) on a flat, straight, dry road. Do not exceed this limit, the posted towing speed limit or the speed limit for your trailer as set forth in your trailer owner's manual, whichever is lowest. Instability of the towing vehicle-trailer combination (trailer sway) increases as speed increases. Exceeding speed limits may cause loss of control.
- Before starting out, check the trailer lights, tires and the vehicle-trailer connections. Recheck after driving a short distance.
- Practice turning, stopping and reversing with the trailer attached in an area away from traffic until you become accustomed to the feel of the vehicle-trailer combination.
- Reversing with a trailer attached is difficult and requires practice. Grip the bottom of the steering wheel and move your hand to the left to move the trailer to the left. Move your hand to the right to move the trailer to the right. (This is generally opposite to reversing without a trailer attached.) Avoid sharp or prolonged turning. Have someone guide you when reversing to reduce the risk of an accident.

2

When driving

2-5. Driving information

- As stopping distance is increased when towing a trailer, vehicle-to-vehicle distance should be increased. For each 10 mph (16 km/h) of speed, allow at least one vehicle and trailer length.
- Avoid sudden braking as you may skid, resulting in the trailer jackknifing and a loss of vehicle control. This is especially true on wet or slippery surfaces.
- Avoid jerky starts or sudden acceleration.
- Avoid jerky steering and sharp turns, and slow down before making a turn.
- Note that when making a turn, the trailer wheels will be closer than the vehicle wheels to the inside of the turn. Compensate by making a wider than normal turning radius.
- Slow down before making a turn, in crosswinds, on wet or slippery surfaces, etc.
Increasing vehicle speed can destabilize the trailer.
- Take care when passing other vehicles. Passing requires considerable distance. After passing a vehicle, do not forget the length of your trailer, and be sure you have plenty of room before changing lanes.
- To maintain engine braking efficiency and charging system performance when using engine braking, do not put the transmission in D.
Transmission shift range position must be in 4 in the S mode.
- Instability happens more frequently when descending steep or long downhill grades. Before descending, slow down and downshift. Do not make sudden downshifts while descending steep or long downhill grades.

- Avoid holding the brake pedal down too long or applying the brakes too frequently. This could cause the brakes to overheat and result in reduced braking efficiency.
- Due to the added load of the trailer, your vehicle's engine may overheat on hot days (at temperatures over 85°F [30°C]) when driving up a long or steep grade. If the Engine coolant temperature gauge indicates overheating, immediately turn off the air conditioning (if in use), pull your vehicle off the road and stop in a safe spot. (→P. 603)
- Always place wheel blocks under both the vehicle's and the trailer's wheels when parking. Apply the parking brake firmly, and put the transmission in P. Avoid parking on a slope, but if unavoidable, do so only after performing the following:
 - STEP 1** Apply the brakes and keep them applied.
 - STEP 2** Have someone place wheel blocks under both the vehicle's and trailer's wheels.
 - STEP 3** When the wheel blocks are in place, release the brakes slowly until the blocks absorb the load.
 - STEP 4** Apply the parking brake firmly.
 - STEP 5** Shift into P and turn off the engine.

2-5. Driving information

● When restarting after parking on a slope:

STEP 1 With the transmission in P, start the engine. Be sure to keep the brake pedal pressed.

STEP 2 Shift into a forward gear. If reversing, shift into R.

STEP 3 Release the parking brake and brake pedal, and slowly pull or back away from the wheel blocks. Stop and apply the brakes.

STEP 4 Have someone retrieve the blocks.

■ Matching trailer ball height to trailer coupler height

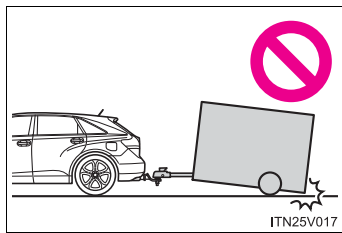

No matter which class of tow hitch applies, for a more safe trailer hookup, the trailer ball setup must be proper height for the coupler on the trailer.

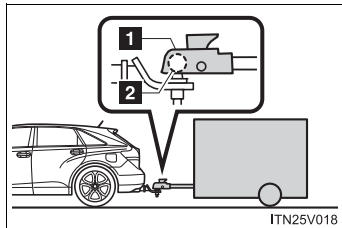

- 1** Coupler
- 2** Trailer ball

■ Before towing

Check that the following conditions are met:

- Ensure that your vehicle's tires are properly inflated. (→P. 622)
- Trailer tires are inflated according to the trailer manufacturer's recommendation.
- All trailer lights work as required by law.
- All lights work each time you connect them.
- The trailer ball is set at the proper height for the coupler on the trailer.
- The trailer is level when it is hitched.
Do not drive if the trailer is not level, and check for improper tongue weight, overloading, worn suspension, or other possible causes.
- The trailer cargo is securely loaded.
- The rear view mirrors conform to all applicable federal, state/provincial or local regulations. If they do not, install rear view mirrors appropriate for towing purposes.

■ Break-in schedule

If your vehicle is new or equipped with any new power train components (such as an engine, transmission, differential or wheel bearing), Toyota recommends that you do not tow a trailer until the vehicle has been driven for over 500 miles (800 km).

After the vehicle has been driven for over 500 miles (800 km), you can start towing. However, for the next 500 miles (800 km), drive the vehicle at a speed of less than 50 mph (80 km/h) when towing a trailer, and avoid full throttle acceleration.

2-5. Driving information

■ Maintenance

- If you tow a trailer, your vehicle will require more frequent maintenance due to the additional load. (See “Scheduled Maintenance Guide” or “Owner’s Manual Supplement”.)
- Retighten the fixing bolts of the towing ball and bracket after approximately 600 miles (1000 km) of trailer towing.

■ If trailer sway occurs

One or more factors (crosswinds, passing vehicles, rough roads, etc.) can adversely affect handling of your vehicle and trailer, causing instability.

- If trailer swaying occurs:

- Firmly grip the steering wheel. Steer straight ahead.
Do not try to control trailer swaying by turning the steering wheel.
- Begin releasing the accelerator pedal immediately but very gradually to reduce speed.
Do not increase speed. Do not apply vehicle brakes.

If you make no extreme correction with the steering or brakes, your vehicle and trailer should stabilize.

- After the trailer swaying has stopped:

- Stop in a safe place. Get all occupants out of the vehicle.
- Check the tires of the vehicle and the trailer.
- Check the load in the trailer.
Make sure the load has not shifted.
Make sure the tongue weight is appropriate, if possible.
- Check the load in the vehicle.
Make sure the vehicle is not overloaded after occupants get in.

If you cannot find any problems, the speed at which trailer swaying occurred is beyond the limit of your particular vehicle-trailer combination.

Drive at a lower speed to prevent instability. Remember that swaying of the towing vehicle-trailer increases as speed increases.

⚠ CAUTION**■ Trailer towing precautions**

To tow a trailer safely, use extreme care and drive the vehicle in accordance with the trailer's characteristics and operating conditions. Failure to do so could cause an accident resulting in death or serious injury. Vehicle stability and braking performance are affected by trailer stability, brake setting and performance, and the hitch. Your vehicle will handle differently when towing a trailer.

■ To avoid accident or injury

- Do not exceed the TWR, unbraked TWR, GCWR, GVWR or GAWR.
- Vehicles with a towing package: If the gross trailer weight is over 2000 lb. (907 kg), a sway control device with sufficient capacity is required.
- Adjust the tongue weight within the appropriate range. Place heavier loads as close to the trailer axle as possible.
- Do not exceed 65 mph (104 km/h), the posted towing speed limit or the speed limit for your trailer as set forth in your trailer owner's manual, whichever is lowest. Slow down sufficiently before making a turn, in crosswinds, on wet or slippery surface, etc. to help avoid an accident. If you experience a vehicle-trailer instability from reducing a certain speed, slow down and make sure you keep your vehicle speed under the speed of which you experience the instability.
- Do not make jerky, abrupt or sharp turns.
- Do not apply the brakes suddenly as you may skid, resulting in jackknifing and loss of vehicle control. This is especially true on wet or slippery surfaces.
- Do not exceed the trailer hitch assembly weight, gross vehicle weight, gross axle weight and trailer tongue weight capacities.

 CAUTION

■ **To avoid accident or injury**

- Do not use cruise control when towing.
- Slow down and downshift before descending steep or long downhill grades. Do not make sudden downshifts while descending steep or long downhill grades.
- Vehicle-trailer instability is more likely on steep long downhills. Before descending steep or long downhill grades, slow down and downshift. Do not make sudden downshifts when descending steep or long downhill grades. Avoid holding the brake pedal down too long or applying the brakes too frequently. This could cause the brakes to overheat and result in reduced braking efficiency.
- Do not tow a trailer when the compact spare tire is installed on your vehicle.

■ **Hitch**

Trailer hitch assemblies have different weight capacities established by the hitch manufacturer. Even though the vehicle may be physically capable of towing a higher weight, the operator must determine the maximum weight rating of the particular hitch assembly and never exceed the maximum weight rating specified for the trailer-hitch. Exceeding the maximum weight rating set by the trailer-hitch manufacturer can cause an accident resulting in death or serious personal injuries.

⚠ CAUTION**■ When towing a trailer**

Toyota recommends trailers with brakes that conform to any applicable federal and state/provincial regulations.

- If the gross trailer weight exceeds unbraked TWR, trailer brakes are required. Toyota recommends trailers with brakes that conform to all applicable federal and state/provincial regulations.
- Never tap into your vehicle's hydraulic system, as this will lower the vehicle's braking effectiveness.
- Never tow a trailer without using a safety chain securely attached to both the trailer and the vehicle. If damage occurs to the coupling unit or hitch ball, there is danger of the trailer wandering into another lane.

⚠ NOTICE**■ When installing a trailer hitch**

Use only the position recommended by your Toyota dealer. Do not install the trailer hitch on the bumper; this may cause body damage.

■ Do not directly splice trailer lights

Do not directly splice trailer lights. Directly splicing trailer lights may damage your vehicle's electrical system and cause a malfunction.

2-5. Driving information

Dinghy towing

Your vehicle is not designed to be dinghy towed (with four wheels on the ground) behind a motor home.

NOTICE

■ To avoid serious damage to your vehicle

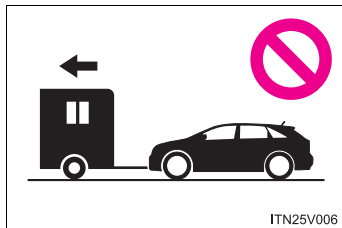

Do not tow your vehicle with four wheels on the ground.

■ To prevent causing serious damage to the transmission and Active Torque Control 4WD system (AWD models)

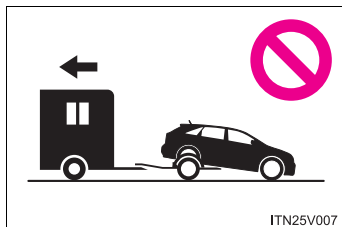

2WD models: Never tow this vehicle from the rear with the front wheels on the ground. This may cause serious damage to the transmission.

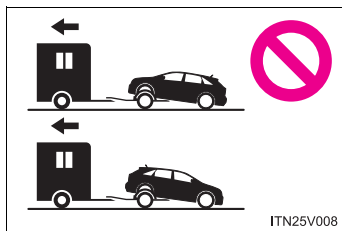

AWD models: Never tow this vehicle with any of the wheels on the ground. This may cause serious damage to the transmission and Active Torque Control 4WD system.

2-5. Driving information

2

When driving

3-1. Using the air conditioning system and defogger

Automatic air conditioning system 306
 Rear window defogger 316

3-2. Using the audio system (Entune Audio)

Audio system types 318
 Audio system 320
 Steering wheel audio switches 323
 USB Port/AUX Port 325
 Basic Audio Operations 326
 Setup menu 329
 General settings 330
 Audio settings 332
 Display settings 333
 Voice settings 335

Selecting the audio source 336
 List screen operation 337
 Optimal use of the audio system 339
 Radio operation 340
 CD player operation 343
 Listening to an iPod 350
 Listening to a USB memory device 356
 Using the AUX port 362
 Preparations to use wireless communication 363
 Registering a Bluetooth® audio player for the first time 366
 Registering a Bluetooth® phone for the first time 367
 Registering a Bluetooth® device 368
 Connecting a Bluetooth® device 370

Interior features

3

Displaying a Bluetooth® device details	373
Detailed Bluetooth® system settings	375
Listening to Bluetooth® Audio.....	377
Using a Bluetooth® Phone	379
Making a call	382
Receiving a call.....	386
Speaking on the phone	387
Bluetooth® phone message function.....	391
Using the steering wheel switches	396
Bluetooth® phone settings	397
Contact/Call History Settings.....	399
What to do if... (Troubleshooting).....	411
Bluetooth®	419
Voice command system	426

3-3. Using the interior lights

Interior lights list	430
• Personal/interior light main switch	431
• Personal/interior lights and luggage compartment light	432

3-4. Using the storage features

List of storage features	434
• Glove box.....	435
• Console boxes	436
• Overhead console.....	438
• Cup holders	439
• Bottle holders	441
• Auxiliary boxes.....	442

3-5. Other interior features

Sun visors	445
Vanity mirror.....	446
Power outlets	447
Seat heaters.....	449
Armrest	451
Assist grips (folding type)	452
Floor mats	453
Luggage compartment features	455
Garage door opener.....	457
Compass.....	464

3-1. Using the air conditioning system and defogger Automatic air conditioning system

Airflow and outlets are automatically adjusted according to the temperature setting.

► Control panel

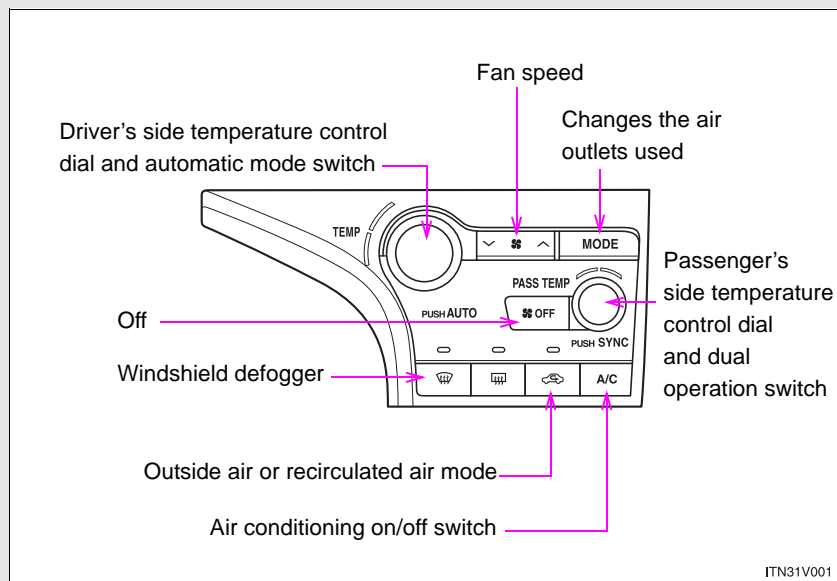

3-1. Using the air conditioning system and defogger

► Multi-information display (TFT type)

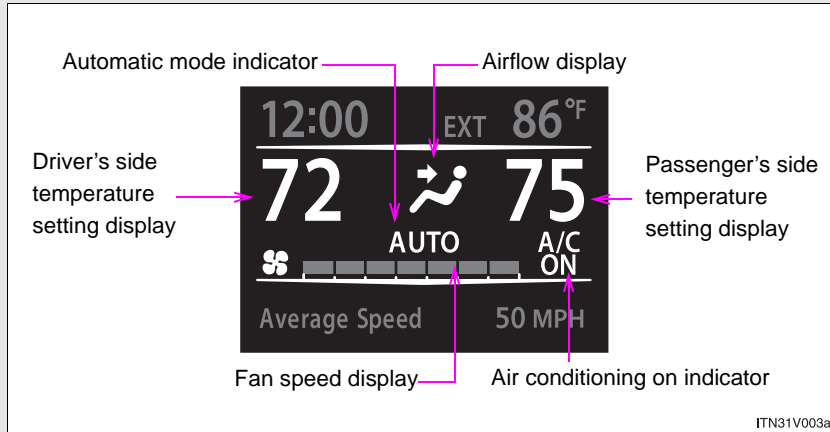

The settings display will differ according to the situation. If  is pressed while in automatic mode, the status of all settings will be displayed for a number of seconds.

► Multi-information display (LCD type)

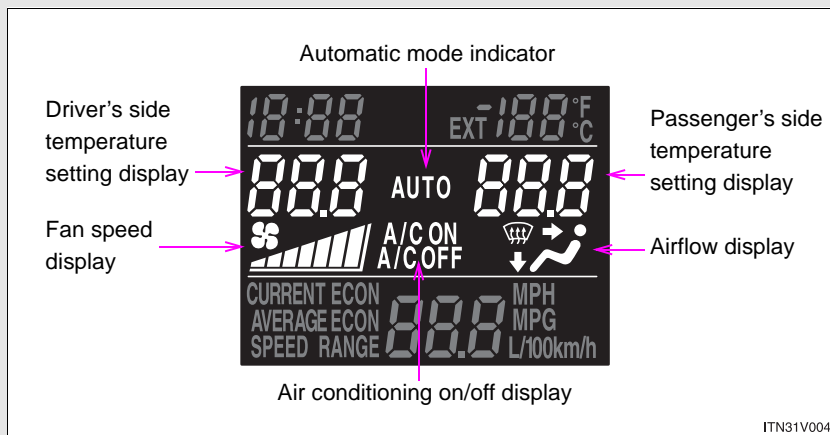

Using the automatic mode

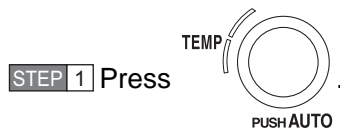

The air conditioning system will begin to operate. In outside air or recirculated air mode, air outlets, fan speed and air conditioning on/off are automatically adjusted according to the temperature setting.

“AUTO” will be displayed on the multi-information display, along with the temperature setting. The settings that are automatically adjusted by the system are not displayed. When only “AUTO” and the temper-

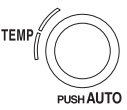
ature settings are displayed,  may be pressed a second time to temporarily display all system settings.

STEP 2 Turn the temperature control dial clockwise (warm) or counterclockwise (cool).

The temperature for the driver’s and front passenger’s seats can be set separately.

■ Automatic mode indicator

If the fan speed setting or air flow modes are operated, the automatic mode indicator goes off. However, automatic mode for functions other than that operated are maintained.

Adjusting the settings

■ Adjusting the temperature setting

Turn the temperature control dial clockwise (warm) or counter-clockwise (cool).

The air conditioning system switches between dual and simultaneous modes each time  is pressed.

Each temperature setting will be displayed on the multi-information display.

Dual mode: The temperature for the driver's seat and front passenger's seats can be set separately.

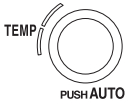
SYNC mode: Only  (driver's side) can be used to adjust the temperature for all seats.

In SYNC mode, only one temperature setting will be displayed on the multi-information display.

3-1. Using the air conditioning system and defogger

■ Adjusting the fan speed

Press “^” (increase) or “v” (decrease) on .

The fan speed is shown on the display. (7 levels)
Pressing the button while in automatic mode will place the fan speed into manual mode. “AUTO” will turn off, and the fan speed setting will be displayed. The air outlet setting will remain in automatic mode.

Press  to turn the fan off.

The air conditioning system display will go blank to indicate that the system is off. If the system is in outside air mode, some outlet airflow may still exist.

■ Changing the air outlets

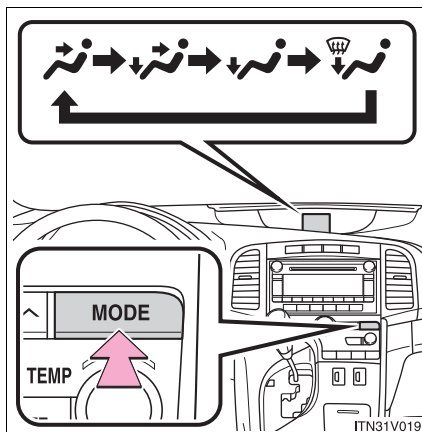

Press .

The air outlets switch each time the button is pressed.

Pressing the button while in automatic mode will place the air outlets into manual mode. “AUTO” will turn off, and the air outlet setting will be displayed. The fan speed setting will remain in automatic mode.

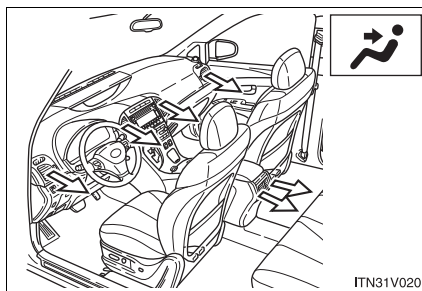

Air flows to the upper body.

3-1. Using the air conditioning system and defogger

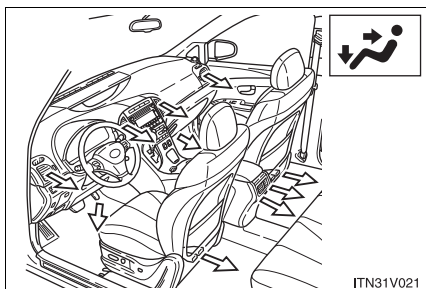

Air flows to the upper body and feet.

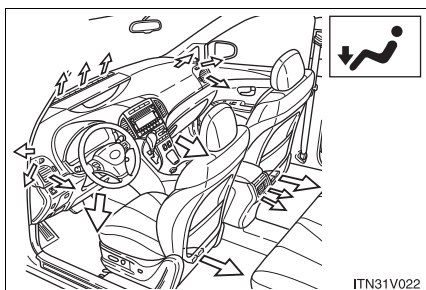

Mainly air flows to the feet.

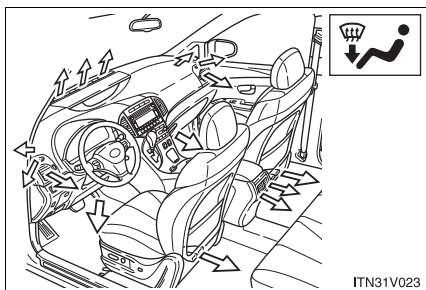

Air flows to the feet and the windshield defogger operates.

■ Switching between outside air and recirculated air modes

Press  .

The mode switches between outside air mode (indicator off) and recirculated air mode (indicator on) each time the button is pressed.

3-1. Using the air conditioning system and defogger

Defogging the windshield

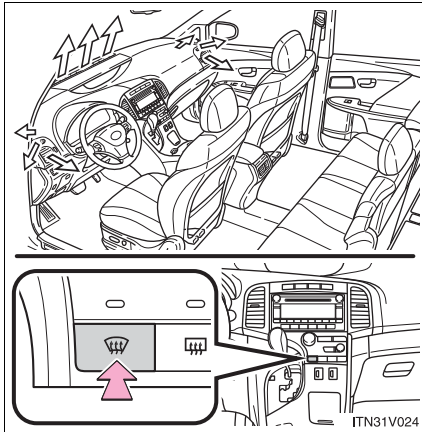

Press .

The air conditioning system control operates automatically.

Recirculated air mode will automatically switch to outside air mode. It is not possible to return to recirculated air mode when the switch is on.

Pressing  again will revert to the previous air outlet mode.

Adjusting the position and opening and closing the air outlets

► Front center outlets

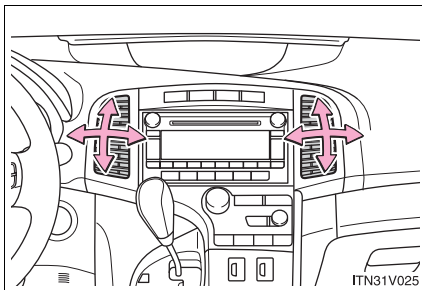

Direct air flow to the left or right, up or down.

3-1. Using the air conditioning system and defogger

► Front side outlets

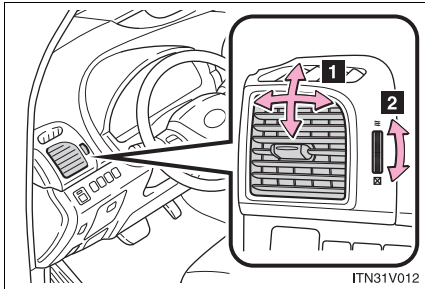

- 1 Direct air flow to the left or right, up or down.
- 2 Turn the knob to open or close the vent.

► Rear center outlets

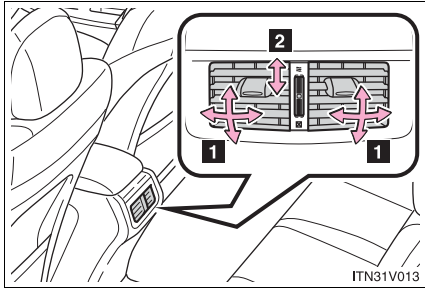

- 1 Direct air flow to the left or right, up or down.
- 2 Turn the knob to open or close the vent.

3 Interior features

3-1. Using the air conditioning system and defogger

■ Using the automatic mode

Fan speed is adjusted automatically in accordance with the temperature setting and ambient conditions. As a result, the following may occur.

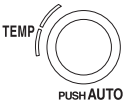
- Immediately after  is pressed, the fan may stop for a while until warm or cool air is ready to flow.
- Cool air may flow to the area around the upper body when the heater is on.

■ Using the system in recirculated air mode

The windows will fog up more easily if the recirculated air mode is used for an extended period.

■ Switching between outside air and recirculated air modes

Recirculated air mode or outside air mode may be automatically switched in accordance with the temperature setting and the inside temperature.

■ When the outside temperature exceeds 75°F (24°C) and the air conditioning system is on

- In order to reduce the air conditioning power consumption, the air conditioning system may switch to recirculated air mode automatically. This may help to improve fuel consumption.
- Vehicles with smart key system:
Recirculated air mode is selected as a default mode when the “ENGINE START STOP” switch is turned to IGNITION ON mode.
- Vehicles without smart key system:
Recirculated air mode is selected as a default mode when the engine switch is turned to the “ON” position.

- It is possible to switch to outside air mode at any time by pressing .

■ Window defogger feature

Recirculated air mode may automatically switch to outside air mode in situations where the windows need to be defogged.

3-1. Using the air conditioning system and defogger

■ When outside temperature reaches approximately 32°F (0°C)

The air conditioning system may not operate even when  is pressed.

■ Ventilation and air conditioning odors

- To let fresh air in, set the air conditioning system to the outside air mode.
- During use, various odors from inside and outside the vehicle may enter into and accumulate in the air conditioning system. This may then cause odor to be emitted from the vents.
- To reduce potential odors from occurring:
 - It is recommended that the air conditioning system be set to outside air mode prior to turning the vehicle off.
 - The start timing of the blower may be delayed for a short period of time immediately after the air conditioning system is started in the automatic mode. Air flows to the feet for a certain period of time when the air starts to flow.

CAUTION

■ To prevent the windshield from fogging up

Do not use  during cool air operation in extremely humid weather. The difference between the temperature of the outside air and that of the windshield can cause the outer surface of the windshield to fog up, blocking your vision.

NOTICE

■ To prevent battery discharge

Do not leave the air conditioning system on longer than necessary when the engine is stopped.

3-1. Using the air conditioning system and defogger Rear window defogger

Clear the rear window using the defogger.

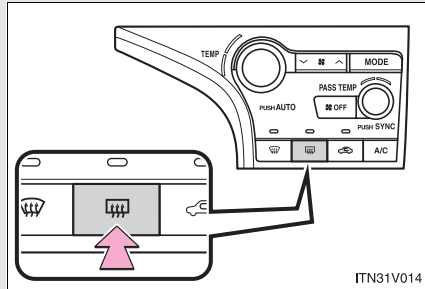

On/off

The defogger will automatically turn off after 15 or 60 minutes. This operation time changes according to the ambient temperature and vehicle speed. Pressing the switch again also turns the defogger off.

■ The rear window defogger can be operated when

- ▶ Vehicles with smart key system
The "ENGINE START STOP" switch is in IGNITION ON mode.
- ▶ Vehicles without smart key system
The engine switch is in the "ON" position.

■ Outside rear view mirror defoggers and windshield wiper de-icer

Turning the rear window defogger on will turn the outside rear view mirror defoggers and the windshield wiper de-icer on.

The outside rear view mirror is used to remove raindrops, dew and frost from the outside rear view mirrors.

The windshield wiper de-icer is used to prevent ice from building up on the windshield and wiper blades.

3-1. Using the air conditioning system and defogger

CAUTION

■ **Outside rear view mirror defoggers and windshield wiper de-icer**

Do not touch the rear view mirror surfaces, the glass at the lower part of the windshield or to the side of the front pillars, as they can become very hot and burn you.

NOTICE

■ **To prevent battery discharge**

Turn the defoggers off when the engine is not running.

3-2. Using the audio system (Entune Audio) Audio system types*

Refer to each type models depending on your system type.

- ▶ Vehicles with an Entune Premium Audio with Navigation
Refer to the “NAVIGATION AND MULTIMEDIA SYSTEM OWNER’S MANUAL”.
- ▶ Vehicles with an Entune Audio Plus
Refer to the “NAVIGATION AND MULTIMEDIA SYSTEM OWNER’S MANUAL”.

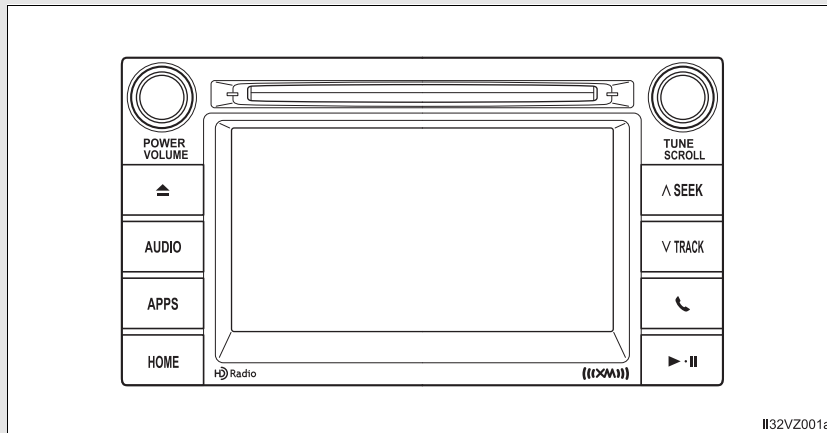

*: If equipped

3-2. Using the audio system (Entune Audio)

► Vehicles with an Entune Audio

→P. 320

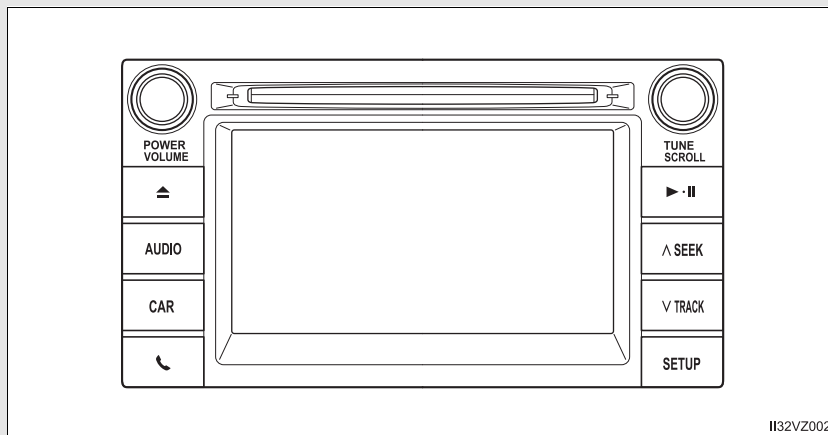

3

Interior features

3-2. Using the audio system (Entune Audio) Audio system*

Operations such as listening to audio, using the hands-free phone, confirming vehicle information and changing audio system settings are started by using the following buttons.

■ Audio system operation buttons

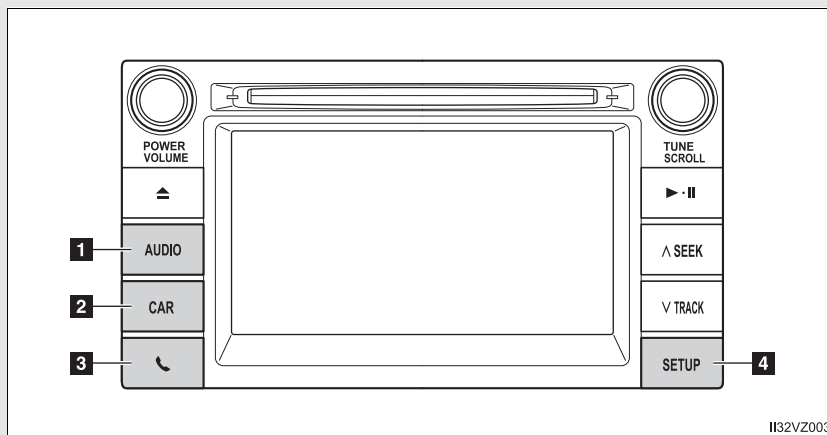

1 "AUDIO" button

Display the "Select Audio Source" screen or audio top screen.
(→P. 336)

2 "CAR" button

Press this button to access the vehicle information system.
(→P. 210)

3 button

Press this button to access the Bluetooth® hands-free system.
(→P. 379)

4 "SETUP" button

Press this button to customize the function settings. (→P. 329)

*: If equipped

Operating the touch screen

By touching the screen with your finger, you can control the audio system, etc.

■ Touch

Quickly touch and release once.

- Changing and selecting various settings

■ Drag*

Touch the screen with your finger, and move the screen to the desired position.

- Scrolling the lists

■ Flick*

Touch the screen with your finger and quickly move the screen by flicking your finger.

- Moving the list screen (list screen limit)

*: The above operations may not be performed on all screens.

■ When using the touch screen

- If the screen is cold, the display may be dark, or the system may seem to be operating slightly slower than normal.
- The screen may seem dark and hard to see when viewed through sunglasses. Change your angle of viewing, adjust the display on the "Display Settings" screen (→P. 333) or remove your sunglasses.

3-2. Using the audio system (Entune Audio)

 NOTICE

■ **To avoid damaging the touch screen**

- To prevent damaging the screen, lightly touch the screen buttons with your finger.
- Do not use objects other than your finger to touch the screen.
- Wipe off fingerprints using a glass cleaning cloth. Do not use chemical cleaners to clean the screen, as they may damage the touch screen.

3-2. Using the audio system (Entune Audio) Steering wheel audio switches*

Some audio features can be controlled using the switches on the steering wheel.

Operation may differ depending on the type of audio system or navigation system. For details, refer to the manual provided with the audio system or navigation system.

Operating the audio system using the steering wheel switches

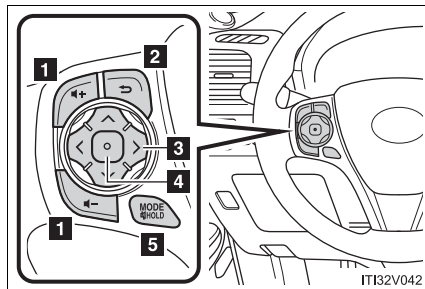

1 Volume switch

- Increases/decreases volume
- Press and hold: Continuously increases/decreases volume

2 Back switch

- Returns to the previous screen (Only when “Back button” is displayed)

3 Cursor switch

“^” and “v” button

- Selects (radio stations/tracks/files/songs/videos)
- Moves cursor
- Press and hold:
 - Fast preset/station up/down
 - Fast track up/down (tracks/files/songs)

3

Interior features

*: If equipped

3-2. Using the audio system (Entune Audio)

“>” and “<” button

- Tab change
- Press and hold:
 - Seek up/down (radio stations)
 - Fast up/down (tracks/files/videos)

4 Enter switch

- Displays the audio screen (Except when audio screen is displayed)
- Displays the preset/list screen (When audio screen is displayed)
- Selects items (When audio list screen is displayed)

5 “MODE/HOLD” switch

- Changes audio source
- Press and hold this switch to mute or pause the current operation
 - To cancel the mute or pause, press and hold.

 CAUTION

■ To reduce the risk of an accident

Exercise care when operating the audio switches on the steering wheel.

3-2. Using the audio system (Entune Audio) USB Port/AUX Port

Connect an iPod, USB memory device or portable audio player to the USB/AUX port as indicated below. Select “iPod”, “USB” or “AUX” on the audio source selection screen and the device can be operated via audio system.

Connecting using the USB/AUX port

■ iPod

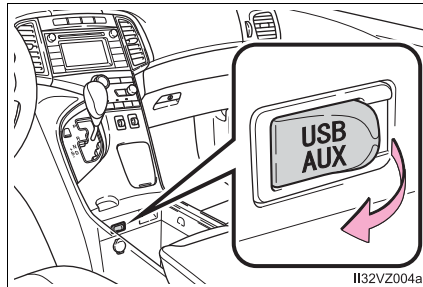

Open the cover and connect an iPod using an iPod cable.

Turn on the power of the iPod if it is not turned on.

■ USB memory

Open the cover and connect the USB memory device.

Turn on the power of the USB memory device if it is not turned on.

■ Portable audio player

Open the cover and connect the portable audio player.

Turn on the power of the portable audio player if it is not turned on.

⚠ CAUTION

■ While driving

Do not connect a device or operate the device controls.

3-2. Using the audio system (Entune Audio) Basic Audio Operations

Basic audio operations and functions common to each mode are explained in this section.

■ Operating the audio system

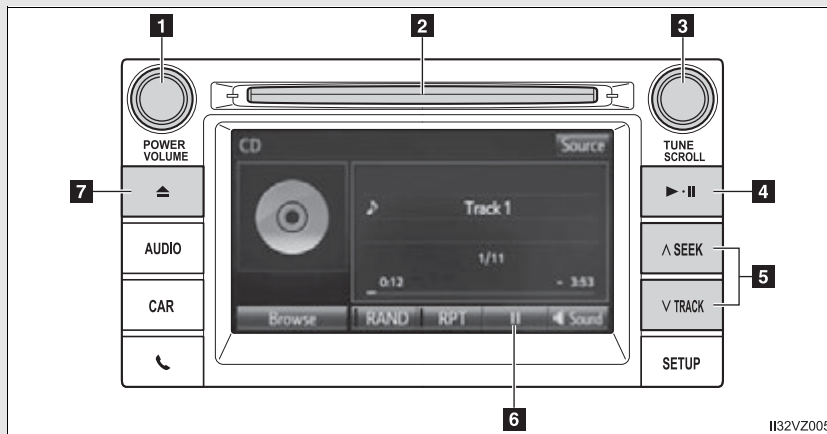

- 1** Press this knob to turn the audio system on and off, and turn it to adjust the volume.
- 2** Insert a disc into the disc slot
- 3** Turn this knob to select radio station bands, tracks and files. Also the knob can be used to select items in the list display.
- 4** Press this button to mute or pause the current operation. To cancel the mute or pause, press.
- 5** Press the button to seek up or down for a radio station, or to access a desired track or file.
- 6** : Select to pause music.
 : Select to resume playing music.
- 7** Press this button to eject a disc

Random playback

Select **RAND** to change on/off.

Repeat play

Select **RPT** to change on/off.

■ **Using cellular phones**

Interference may be heard through the audio system's speakers if a cellular phone is being used inside or close to the vehicle while the audio system is operating.

CAUTION

■ **Laser product**

For vehicles sold in the U.S.A., Hawaii, Guam, Puerto Rico and Canada

CAUTION:
THIS PRODUCT IS A CLASS 1 LASER
PRODUCT. USE OF CONTROLS OR
ADJUSTMENTS OR PERFORMANCE OF
PROCEDURES OTHER THAN THOSE
SPECIFIED HEREIN MAY RESULT IN
HAZARDOUS RADIATION EXPOSURE.
DO NOT OPEN COVERS AND DO NOT REPAIR
BY YOURSELF. REFER SERVICING TO
QUALIFIED PERSONNEL.

3-2. Using the audio system (Entune Audio)

 NOTICE

■ **To prevent battery discharge**

Do not leave the audio system on longer than necessary when the engine is off.

■ **To avoid damaging the audio system**

Take care not to spill drinks or other fluids on the audio system.

3-2. Using the audio system (Entune Audio) Setup menu

You can adjust the audio system to your desired settings.

Display “Setup” screen

Press the “SETUP” button to display the “Setup” screen.

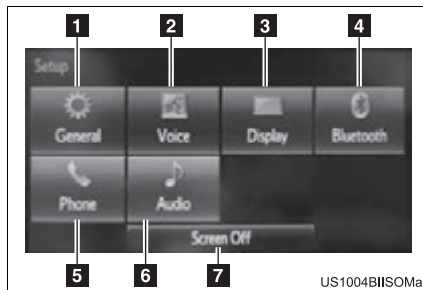

- 1** Select to adjust the settings for operation sounds, screen animation, etc. (→P. 330)
- 2** Select to display the voice settings screen. (→P. 335)
- 3** Select to adjust the settings for contrast and brightness of the screen. (→P. 333)
- 4** Select to adjust the settings for registering, removing, connecting and disconnecting Bluetooth® devices. (→P. 375)
- 5** Select to adjust the settings for contact, message settings, etc. (→P. 399)
- 6** Select to set audio settings. (→P. 332)
- 7** Select to turn the screen off.

3

Interior features

3-2. Using the audio system (Entune Audio) General settings

Settings are available for adjusting the operation sounds, screen animation, etc.

Screen for general settings

STEP 1 Press the “SETUP” button.

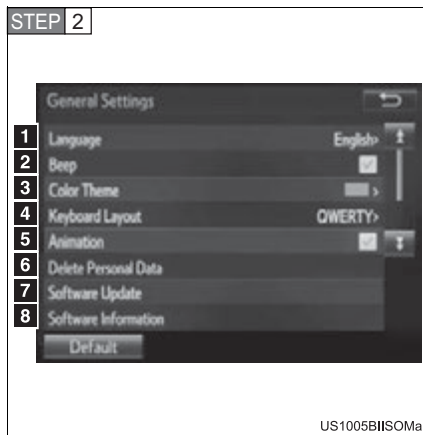

Select “General” on the “Setup” screen.

- 1** “English”, “Français” or “Español” can be selected.
- 2** On/off can be selected to sound beeps.
- 3** Select to change the screen color.
- 4** Select to change the keyboard layout.
- 5** The animation effect for the screen can be set to on/off.
- 6** Select to delete personal data (→P. 331)
- 7** Select to update program versions. For details, contact your Toyota dealer.
- 8** Select to display the software information. Notices related to third party software used in this product are enlisted. (This includes instructions for obtaining such software, where applicable.)

■ **To return to the default settings**

Select "Default", and then "Yes".

Delete personal data

STEP 1 Select "Delete Personal Data" on the "General Settings" screen.

STEP 2 Select "Delete".

Check carefully beforehand, as data cannot be retrieved once deleted.

STEP 3 A confirmation screen will be displayed. Select "Yes".

The following personal data will be deleted or changed to its default settings.

- General settings
- Audio settings
- Phone settings

3-2. Using the audio system (Entune Audio) Audio settings

Settings are available for adjusting the radio operation, cover art, etc.

Screen for audio settings

STEP 1 Press the “SETUP” button.

STEP 2 Select “Audio” on the “Setup” screen.

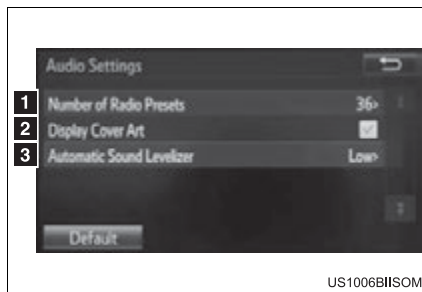

- 1** Number of Radio Presets
Select the number of radio preset stations.
- 2** Display Cover Art on/off
- 3** Automatic Sound Levelizer

Automatic sound leveliser (ASL)

STEP 1 Select “Automatic Sound Levelizer”.

STEP 2 Select “High”, “Mid”, “Low” or “Off”.

■ The sound quality level is adjusted individually

The treble, mid and bass levels can be adjusted for each audio mode separately.

■ About Automatic Sound Leveliser (ASL)

ASL automatically adjusts the volume and tone quality according to the vehicle speed.

3-2. Using the audio system (Entune Audio) Display settings

Settings are available for adjusting the contrast and brightness of the screen.

Screen for display settings

STEP 1 Press the “SETUP” button.

STEP 2 Select “Display” on the “Setup” screen.

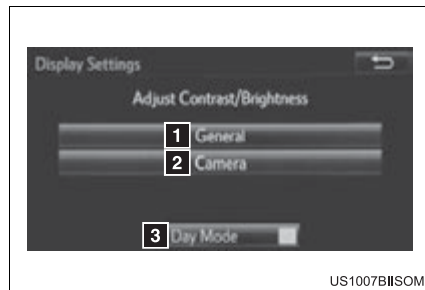

- 1** Adjust the screen display
- 2** Adjust the camera display*
- 3** Changes to day mode.

*: If equipped

Day mode

When the headlights are turned on, the screen dims. However, the screen can be switched to day mode by selecting “Day Mode”.

The screen will stay in day mode when the headlights are turned on until “Day Mode” is selected again.

3

Interior features

3-2. Using the audio system (Entune Audio)

Brightness, contrast, tone and color adjustment

STEP 1 Select “General” or “Camera” on the “Display Settings” screen.

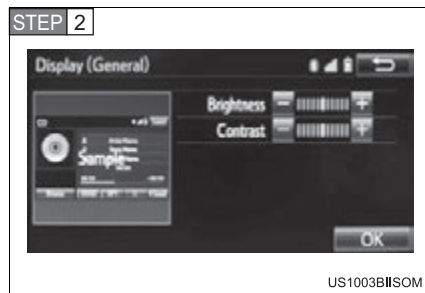

Select the desired item.

	“_”	“+”
“Brightness”	Darker	Brighter
“Contrast”	Weaker	Stronger

3-2. Using the audio system (Entune Audio) Voice settings

This screen is used for setting the voice command guidance system.

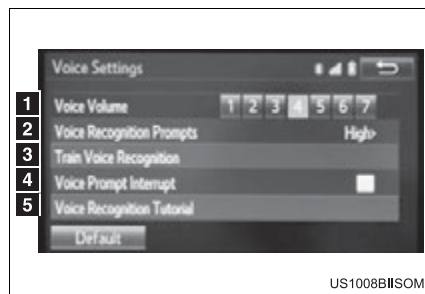

- 1 Adjust the voice guidance volume setting.
- 2 Set the voice recognition prompts "High", "Low" or "Off".
- 3 Train voice recognition
- 4 Set the voice prompt interrupt on/off.
- 5 Voice recognition tutorial

■ To return to the default settings

Select "Default", and then "Yes".

3

Interior features

3-2. Using the audio system (Entune Audio) Selecting the audio source

Switching between audio sources such as radio and CD are explained in this section.

Changing audio source

STEP 1 Press the “AUDIO” button to display the audio source selection screen.

If the audio source selection screen is not displayed, press the “AUDIO” button again.



Select the desired audio source.

1 Select the desired audio source then ◀ or ▶ to reorder.

Using the steering wheel switches to change audio source



The audio source changes as follows each time the “MODE/HOLD” switch is pressed.



3-2. Using the audio system (Entune Audio) List screen operation

When a list screen is displayed, use the appropriate buttons to scroll through the list.

How to scroll



 : Select to scroll to the next or previous page.

: If  appears to the right of titles, the complete titles are too long for the display. Select this button to scroll the title.

Turn the “TUNE•SCROLL” knob to move the cursor box to select a desired item from the list, and press the knob to play it. The track that is being played is highlighted.

To return to the top screen, select “Now Playing” on the list screen.

3

Interior features

Selecting, fast-forwarding and reversing tracks/files/songs

■ **Selecting a track/file/song**

Press the “SEEK >” button or “< TRACK” button, or turn the “TUNE•SCROLL” knob to select the desired track/file/song number.

To fast-forward or reverse, press and hold the “SEEK >” button or “< TRACK” button.

■ **Selecting a track/file/song from the track/file/song list**

STEP 1 Select “Browse” or cover art.

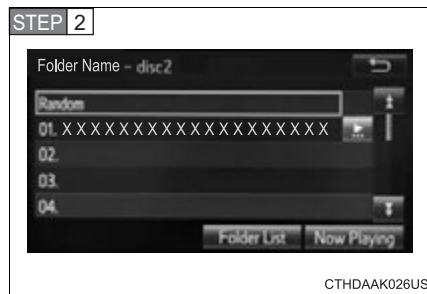

Select the desired track/file/song.

When an MP3/WMA/AAC disc or USB memory device is being used, the folder can be selected. When a Bluetooth® device or iPod is being used, the album can be selected.

According to the audio device, the following is displayed.

Audio source	List name
Audio CD	Track
MP3/WMA/AAC disc, USB	Folder, Album, Artist, Song, Composer, Genre, File
Bluetooth®	Album, Track
iPod	Playlist, Artist, Album, Genre, Audiobook, Composer, Song, Video, Podcast

3-2. Using the audio system (Entune Audio) Optimal use of the audio system

On the “Sound Settings” screen, sound quality (Treble/Mid/Bass), volume balance can be adjusted.

How to adjust the sound settings and sound quality

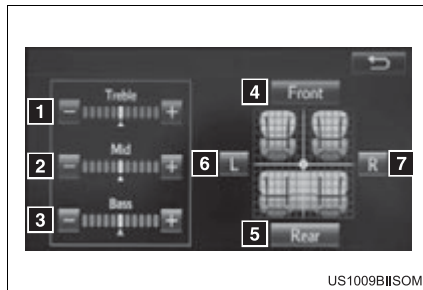

- 1 2 3** Select “-” or “+” to adjust the treble, mid or bass to a level between -5 and 5.
- 4 5** Select “Front” or “Rear” to adjust the front/rear audio balance.
- 6 7** Select “L” or “R” to adjust the left/right audio balance.

3

Interior features

3-2. Using the audio system (Entune Audio) Radio operation

Select “AM” or “FM” on the audio source selection screen to begin listening to the radio.

Audio control screen

Pressing the “AUDIO” button displays the audio control screen from any screens of the selected source.

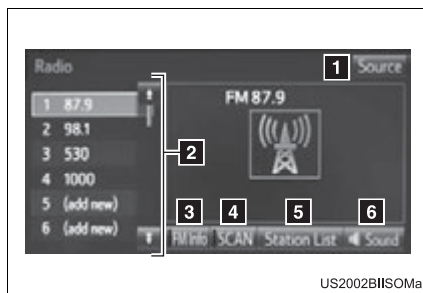

- 1 Audio source selection screen appears
- 2 Preset stations
- 3 FM only: Select to display RBDS text messages.
- 4 Scanning for receivable station
- 5 Select to display a list of receivable stations
- 6 Setting the sound (→P. 339)

Selecting a station

Tune in to the desired station using one of the following methods.

■ Seek tuning

Press the “SEEK >” button or “< TRACK” button.

The radio will begin seeking up or down for a station of the nearest frequency and will stop when a station is found.

■ Manual tuning

Turn the “TUNE•SCROLL” knob.

■ Preset stations

Select the desired preset station.

Setting station presets

STEP 1 Search for desired stations by turning the “TUNE•SCROLL” knob or pressing the “SEEK >” button or “< TRACK” button.

STEP 2 Select “(add new)”.

To change the preset station to a different one, select and hold the preset station.

STEP 3 Select “Yes”.

STEP 4 Select “OK” after setting the new preset station.

■ Refreshing the station list

STEP 1 Select “Refresh” on the “Station List” screen.

To cancel the refresh, select “Cancel Refresh”.

Radio Broadcast Data System

This audio system is equipped with Radio Broadcast Data Systems (RBDS). RBDS mode allows text messages to be received from radio stations that utilize RBDS transmitters.

When RBDS is on, the radio can

- only select stations of a particular program type,
- display messages from radio stations.

RBDS features are available only when listening to an FM station that broadcasts RBDS information and the “FM Info” indicator is on.

3-2. Using the audio system (Entune Audio)

■ Selecting a desired genre

STEP 1 Select "Station List".

STEP 2 FM radio only: Select a desired genre of station and select a desired station.

● The genre list is in the following order:

- Classical
- Country
- EasyLis (Easy Listening)
- Inform (Information)
- Jazz
- News
- Oldies
- Other
- Pop Music
- Religion
- Rock
- R&B (Rhythm and Blues)
- Sports
- Talk
- Alert (Emergency Alert)

■ Reception sensitivity

- Maintaining perfect radio reception at all times is difficult due to the continually changing position of the antenna, differences in signal strength and surrounding objects, such as trains, transmitters, etc.
- The radio antenna is mounted on the roof. The antenna can be removed from the base by turning it.

3-2. Using the audio system (Entune Audio) CD player operation

Insert disc or select “CD” on the audio source selection screen with a disc inserted to begin listening to a CD.

Audio control screen

Pressing the “AUDIO” button displays the audio control screen from any screens of the selected source.

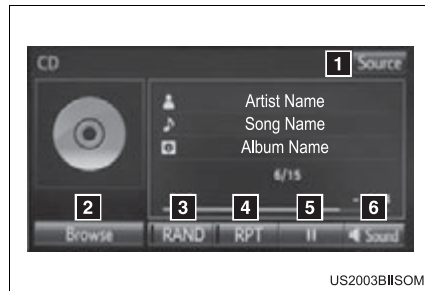

- 1 Audio source selection screen appears
- 2 Displaying the track/file list
- 3 Random playback (→P. 327)
- 4 Repeat play (→P. 327)
- 5 Pause
Select  to resume play
- 6 Setting the sound (→P. 339)

3

Interior features

■ Displaying the title and artist name

If a CD-TEXT disc is inserted, the title of the disc and track will be displayed.

3-2. Using the audio system (Entune Audio)

■ Error messages

If the following error messages appear on the screen, refer to the table and take the appropriate measures. If the problem is not rectified, take the vehicle to your Toyota dealer.

Message	Cause	Correction procedures
"Check DISC"	<ul style="list-style-type: none">• The disc is dirty or damaged.• The disc is inserted upside down.• The disc is not playable with the player.	<ul style="list-style-type: none">• Clean the disc.• Insert the disc correctly.• Confirm the disc is playable with the player.
"Disc Error"	There is a malfunction within the system.	Eject the disc.
"No music files found."	No playable data is included on the disc.	Eject the disc.

■ Discs that can be used

Discs with the marks shown below can be used. Playback may not be possible depending on recording format or disc features, or due to scratches, dirt or deterioration.



CDs with copy-protection features may not play correctly.

■ CD player protection feature

To protect the internal components, playback is automatically stopped when a problem is detected.

■ If a disc is left inside the CD player or in the ejected position for extended periods

Disc may be damaged and may not play properly.

■ **Lens cleaners**

Do not use lens cleaners. Doing so may damage the CD player.

■ **MP3, WMA and AAC files**

MP3 (MPEG Audio LAYER3) is a standard audio compression format.

Files can be compressed to approximately 1/10 of their original size by using MP3 compression.

WMA (Windows Media Audio) is a Microsoft audio compression format.

This format compresses audio data to a size smaller than that of the MP3 format.

This product is protected by certain intellectual property rights of Microsoft Corporation and third parties. Use or distribution of such technology outside of this product is prohibited without a license from Microsoft or an authorized Microsoft subsidiary and third parties.

AAC is short for Advanced Audio Coding and refers to an audio compression technology standard used with MPEG2 and MPEG4.

MP3, WMA and AAC file and media/formats compatibility are limited.

● **MP3 file compatibility**

- Compatible standards
MP3 (MPEG1 LAYER3, MPEG2 LSF LAYER3)
- Compatible sampling frequencies
MPEG1 LAYER3: 32, 44.1, 48 (kHz)
MPEG2 LSF LAYER3: 16, 22.05, 24 (kHz)
- Compatible bit rates (compatible with VBR)
MPEG1 LAYER3: 32-320 (kbps)
MPEG2 LSF LAYER3: 8-160 (kbps)
- Compatible channel modes: stereo, joint stereo, dual channel and monaural

● **WMA file compatibility**

- Compatible standards
WMA Ver. 7, 8, 9
- Compatible sampling frequencies
32, 44.1, 48 (kHz)
- Compatible bit rates (only compatible with 2-channel playback)
Ver. 7, 8: CBR 48-192 (kbps)
Ver. 9: CBR 48-320 (kbps)

3-2. Using the audio system (Entune Audio)

- AAC file compatibility

- Compatible standards
MPEG4/AAC-LC
- Compatible sampling frequencies
11.025/12/16/22.05/24/32/44.1/48 (kHz)
- Compatible bit rates
16-320 (kbps)
- This system can play back AAC files encoded by iTunes.

- Compatible media

Media that can be used for MP3, WMA and AAC playback are CD-Rs and CD-RWs.

Playback in some instances may not be possible if the CD-R or CD-RW is not finalized. Playback may not be possible or the audio may jump if the disc is scratched or marked with fingerprints.

- Compatible disc formats

The following disc formats can be used.

- Disc formats: CD-ROM Mode 1 and Mode 2
CD-ROM XA Mode 2, Form 1 and Form 2
- File formats: ISO9660 Level 1, Level 2, (Romeo, Joliet)
UDF (2.01 or lower)

MP3, WMA and AAC files written in any format other than those listed above may not play correctly, and their file names and folder names may not be displayed correctly.

Items related to standards and limitations are as follows.

- Maximum directory hierarchy: 8 levels (including the root)
- Maximum length of folder names/file names: 32 characters
- Maximum number of folders: 192 (including the root)
- Maximum number of files per disc: 255

- File names

The only files that can be recognized as MP3/WMA/AAC and played are those with the extension .mp3, .wma or .m4a.

- Discs containing multi-session recordings

As the audio system is compatible with multi session discs, it is possible to play discs that contain MP3, WMA and AAC files. However, only the first session can be played.

- ID3, WMA and AAC tags

ID3 tags can be added to MP3 files, making it possible to record the track title, artist name, etc.

The system is compatible with ID3 Ver. 1.0, 1.1, and Ver. 2.2, 2.3 ID3 tags. (The number of characters is based on ID3 Ver. 1.0 and 1.1.)

WMA tags can be added to WMA files, making it possible to record the track title and artist name in the same way as with ID3 tags.

AAC tags can be added to AAC files, making it possible to record the track title and artist name in the same way as with ID3 tags.

- MP3, WMA and AAC playback

When a disc containing MP3, WMA or AAC files is inserted, all files on the disc are first checked. Once the file check is finished, the first MP3, WMA or AAC file is played. To make the file check finish more quickly, we recommend you do not write any files to the disc other than MP3, WMA or AAC files or create any unnecessary folders.

Discs that contain a mixture of music data and MP3, WMA or AAC format data cannot be played.

- Extensions

If the file extensions .mp3, .wma and .m4a are used for files other than MP3, WMA and AAC files, they may be mistakenly recognized and played as MP3, WMA and AAC files. This may result in large amounts of interference and damage to the speakers.

3-2. Using the audio system (Entune Audio)

● Playback

- To play MP3 files with steady sound quality, we recommend a fixed bit rate of at least 128 kbps and a sampling frequency of 44.1 kHz.
- CD-R or CD-RW playback may not be possible in some instances, depending on the characteristics of the disc.
- There is a wide variety of freeware and other encoding software for MP3, WMA and AAC files on the market, and depending on the status of the encoding and the file format, poor sound quality or noise at the start of playback may result. In some cases, playback may not be possible at all.
- When files other than MP3, WMA or AAC files are recorded on a disc, it may take more time to recognize the disc and in some cases, playback may not be possible at all.
- Microsoft, Windows, and Windows Media are the registered trademarks of Microsoft Corporation in the U.S.A. and other countries.

 NOTICE

■ **Discs and adapters that cannot be used**

Do not use the following types of CDs.

Also, do not use 3 in. (8 cm) CD adapters, DualDiscs or printable discs.

Doing so may damage the CD player and/or the CD insert/eject function.

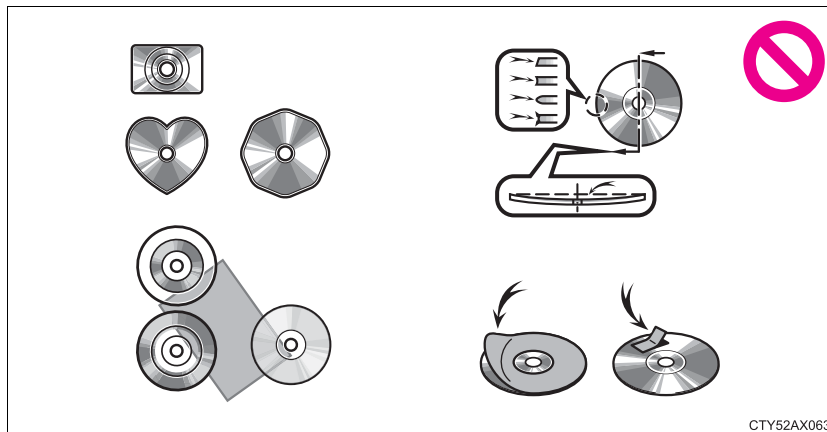

- Discs that have a diameter that is not 4.7 in. (12 cm).
- Low-quality or deformed discs.
- Discs with a transparent or translucent recording area.
- Discs that have tape, stickers or CD-R labels attached to them, or that have had the label peeled off.

■ **Player precautions**

Failure to follow the precautions below may result in damage to the discs or the player itself.

- Do not insert anything other than discs into the disc slot.
- Do not apply oil to the player.
- Store discs away from direct sunlight.
- Never try to disassemble any part of the player.

3-2. Using the audio system (Entune Audio) Listening to an iPod

Connecting an iPod enables you to enjoy music from the vehicle speakers.

Select “iPod” on the audio source selection screen.

When the iPod connected to the system includes iPod video, the system can only output the sound by selecting the browse screen.

Connecting an iPod

→P. 325

Audio control screen

Pressing the “AUDIO” button displays the audio control screen from any screens of the selected source.

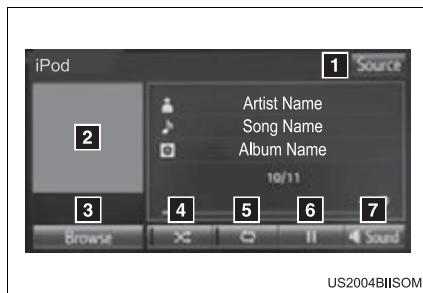

- 1 Audio source selection screen appears
- 2 Displays cover art
- 3 Selecting the play mode (→P. 351)
- 4 Shuffle play (→P. 351)
- 5 Repeat play (→P. 351)
- 6 Pause
Select  to resume playback
- 7 Setting the sound (→P. 339)

Selecting a play mode

STEP 1 Select “Browse” on the screen.

STEP 2 Select the desired play mode by selecting the “Playlists”, “Artists”, “Albums”, “Songs”, “Podcasts”, “Audio books”, “Genres”, “Composers” or “Videos” tab. Then select a song to begin using the selected play mode.

Shuffle play

Select  to change on/off.

Repeat play

Select  to change on/off.

■ About iPod



- “Made for iPod” and “Made for iPhone” mean that an electronic accessory has been designed to connect specifically to iPod or iPhone, respectively, and has been certified by the developer to meet Apple performance standards.
- Apple is not responsible for the operation of this device or its compliance with safety and regulatory standards. Please note that the use of this accessory with iPod or iPhone may affect wireless performance.
- iPhone, iPod, iPod classic, iPod nano, and iPod touch are trademarks of Apple Inc., registered in the U.S. and other countries. Lightning is a trademark of Apple Inc.

3-2. Using the audio system (Entune Audio)

■ iPod cover art

- Depending on the iPod and songs in the iPod, iPod cover art may be displayed.
- This function can be changed to on/off. (→P. 332)
- It may take time to display iPod cover art, and the iPod may not be operated while the cover art display is in process.
- Only iPod cover art that is saved in JPEG format can be displayed.

■ iPod functions

- When an iPod is connected and the audio source is changed to iPod mode, the iPod will resume play from the same point in which it was last used.
- Depending on the iPod that is connected to the system, certain functions may not be available. If a function is unavailable due to a malfunction (as opposed to a system specification), disconnecting the device and reconnecting it may resolve the problem.
- While connected to the system, the iPod cannot be operated with its own controls. It is necessary to use the controls of the vehicle's audio system instead.
- When the battery level of an iPod is very low, the iPod may not operate. If so, charge the iPod before use.
- Compatible models (→P. 354)

■ iPod problems

To resolve most problems encountered when using your iPod, disconnect your iPod from the vehicle iPod connection and reset it. For instructions on how to reset your iPod, refer to your iPod Owner's Manual.

■ Error messages

If the following error messages appear on the screen, refer to the table and take the appropriate measures. If the problem is not rectified, take the vehicle to your Toyota dealer.

Message	Cause/Correction procedures
“Connection error. Please consult your Owner’s Manual for instructions on how to connect the iPod.”	This indicates a problem in the iPod or its connection.
“There are no songs available for playback. Please add compatible files to your iPod.”	This indicates that there is no music data in the iPod.
“No videos found.”	This indicates that no video files are included in the iPod.
“iPod authorization unsuccessful.”	This indicates that the audio system failed to authorize the iPod. Please check your iPod.

3-2. Using the audio system (Entune Audio)

■ Compatible models

The following iPod®, iPod nano®, iPod classic®, iPod touch® and iPhone® devices can be used with this system.

● Made for

- iPod touch (5th generation)
- iPod touch (4th generation)
- iPod touch (3rd generation)
- iPod touch (2nd generation)
- iPod touch (1st generation)
- iPod classic
- iPod with video
- iPod nano (7th generation)
- iPod nano (6th generation)
- iPod nano (5th generation)
- iPod nano (4th generation)
- iPod nano (3rd generation)
- iPod nano (2nd generation)
- iPod nano (1st generation)
- iPhone 5
- iPhone 4S
- iPhone 4
- iPhone 3GS
- iPhone 3G
- iPhone

Depending on differences between models or software versions etc., some models might be incompatible with this system.

CAUTION

■ While driving

Do not connect an iPod or operate the controls.

 NOTICE

■ **To prevent damage to the iPod or its terminals**

- Do not leave the iPod in the vehicle. The temperature inside the vehicle may become high.
- Do not push down on or apply unnecessary pressure to the iPod while it is connected.
- Do not insert foreign objects into the port.

3-2. Using the audio system (Entune Audio) Listening to a USB memory device

Connecting a USB memory device enables you to enjoy music from the vehicle speakers.

Touch “USB” on the audio source selection screen.

Connecting a USB memory device

→P. 325

Audio control screen

Pressing the “AUDIO” button displays the audio control screen from any screens of the selected source.

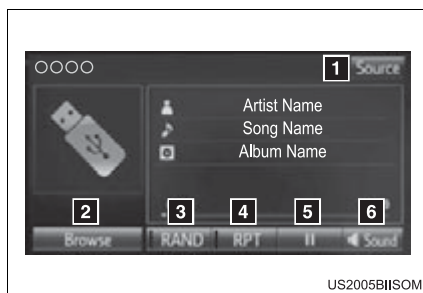

- 1** Audio source selection screen appears
- 2** Displaying the album list
- 3** Random playback (→P. 327)
- 4** Repeat play (→P. 327)
- 5** Pause
Select  to resume playback
- 6** Setting the sound (→P. 339)

■ **USB memory functions**

- Depending on the USB memory device that is connected to the system, the device itself may not be operable and certain functions may not be available. If the device is inoperable or a function is unavailable due to a malfunction (as opposed to a system specification), disconnecting the device and reconnecting it may resolve the problem.
- If the USB memory device still does not begin operation after being disconnected and reconnected, format the memory.

■ **Error messages for USB memory**

If the following error messages appear on the screen, refer to the table and take the appropriate measures. If the problem is not rectified, take the vehicle to your Toyota dealer.

Message	Cause/Correction procedures
“Connection error. Please consult your Owner’s Manual for instructions on how to connect the USB device.”	This indicates a problem with the USB memory device or its connection.
“There are no files available for playback. Please add compatible files to your USB device.”	This indicates that no MP3/WMA/AAC files are included on the USB memory device.

3-2. Using the audio system (Entune Audio)

■ USB memory

● Compatible devices

USB memory device that can be used for MP3, WMA and AAC playback.

● Compatible device formats

The following device format can be used:

- USB communication format: USB2.0 FS (12 Mbps) and USB2.0 HS (480 Mbps)
 - File system format: FAT16/32 (Windows)
 - Correspondence class: Mass storage class
- MP3, WMA and AAC files written to a device with any format other than those listed above may not play correctly, and their file names and folder names may not be displayed correctly.

Items related to standards and limitations are as follows:

- Maximum directory hierarchy: 8 levels
- Maximum number of folders in a device: 3000 (including the root)
- Maximum number of files in a device: 9999
- Maximum number of files per folder: 255

● MP3, WMA and AAC files

MP3 (MPEG Audio LAYER 3) is a standard audio compression format.

Files can be compressed to approximately 1/10 of their original size using MP3 compression.

WMA (Windows Media Audio) is a Microsoft audio compression format. This format compresses audio data to a size smaller than that of the MP3 format.

This product is protected by certain intellectual property rights of Microsoft Corporation and third parties. Use or distribution of such technology outside of this product is prohibited without a license from Microsoft or an authorized Microsoft subsidiary and third parties.

AAC is short for Advanced Audio Coding and refers to an audio compression technology standard used with MPEG2 and MPEG4.

MP3, WMA and AAC file and media/formats compatibility are limited.

- MP3 file compatibility
 - Compatible standards
MP3 (MPEG1 AUDIO LAYERII, III, MPEG2 AUDIO LAYERII, III, MPEG2.5)
 - Compatible sampling frequencies
MPEG1 AUDIO LAYERII, III: 32, 44.1, 48 (kHz)
MPEG2 AUDIO LAYERII, III: 16, 22.05, 24 (kHz)
 - Compatible bit rates (compatible with VBR)
MPEG1 AUDIO LAYERII, III: 32-320 (kbps)
MPEG2 AUDIO LAYERII, III: 8-160 (kbps)
 - Compatible channel modes: stereo, joint stereo, dual channel and monaural
- WMA file compatibility
 - Compatible standards
WMA Ver. 7, 8, 9
 - Compatible sampling frequencies
HIGH PROFILE 32, 44.1, 48 (kHz)
 - Compatible bit rates
HIGH PROFILE 48-320 (kbps, VBR)
- AAC file compatibility
 - Compatible standards
MPEG4/AAC-LC
 - Compatible sampling frequencies
11.025/12/16/22.05/24/32/44.1/48 (kHz)
 - Compatible bit rates
16-320 (kbps)
 - Compatible channel modes: 1 ch and 2 ch
 - This system can play back AAC files encoded by iTunes.
- File names

The only files that can be recognized as MP3/WMA/AAC and played are those with the extension .mp3 or .wma.

3-2. Using the audio system (Entune Audio)

- ID3, WMA and AAC tags

ID3 tags can be added to MP3 files, making it possible to record the track title, artist name, etc.

The system is compatible with ID3 Ver. 1.0, 1.1, and Ver. 2.2, 2.3 ID3 tags. (The number of characters is based on ID3 Ver. 1.0 and 1.1.)

WMA tags can be added to WMA files, making it possible to record the track title and artist name in the same way as with ID3 tags.

AAC tags can be added to AAC files, making it possible to record the track title and artist name in the same way as with ID3 tags.

- MP3, WMA and AAC playback

- When a device containing MP3, WMA and AAC files is connected, all files in the USB memory device are checked. Once the file check is finished, the first MP3, WMA and AAC file is played. To make the file check finish more quickly, we recommend that you do not include any files other than MP3, WMA and AAC files or create any unnecessary folders.
- When a USB memory device is connected and the audio source is changed to USB memory mode, the USB memory device will start playing the first file in the first folder. If the same device is removed and reconnected (and the contents have not been changed), the USB memory device will resume play from the same point in which it was last used.

- Extensions

If the file extensions .mp3, .wma and .m4a are used for files other than MP3, WMA and AAC files, they will be skipped (not played).

- Playback

- To play MP3 files with steady sound quality, we recommend a fixed bit rate of at least 128 kbps and a sampling frequency of 44.1 kHz.
- There is a wide variety of freeware and other encoding software for MP3, WMA and AAC files on the market, and depending on the status of the encoding and the file format, poor sound quality or noise at the start of playback may result. In some cases, playback may not be possible at all.
- Microsoft, Windows, and Windows Media are the registered trademarks of Microsoft Corporation in the U.S.A. and other countries.

3-2. Using the audio system (Entune Audio)

CAUTION

■ While driving

Do not connect a USB memory device or operate the device controls.

NOTICE

■ To prevent damage to the USB memory device or its terminals

- Do not leave the USB memory device in the vehicle. The temperature inside the vehicle may become high.
- Do not push down on or apply unnecessary pressure to the USB memory device while it is connected.
- Do not insert foreign objects into the port.

3-2. Using the audio system (Entune Audio) Using the AUX port

To use the AUX port, connect a portable player, press the “AUDIO” button, then select “AUX” to display the audio control screen.

Connecting a portable audio player

→P. 325

■ Operating portable audio players connected to the audio system

The volume can be adjusted using the vehicle’s audio controls. All other adjustments must be made on the portable audio player itself.

■ When using a portable audio player connected to the power outlet

Noise may occur during playback. Use the power source of the portable audio player.

CAUTION

■ While driving

Do not connect a portable audio player or operate the device controls.

3-2. Using the audio system (Entune Audio) Preparations to use wireless communication

The following can be performed using Bluetooth® wireless communication:

- A portable audio player can be operated and listened to via audio system

- Hands-free phone calls can be made via a cellular phone

In order to use wireless communication, register and connect a Bluetooth® device by performing the following procedures.

3-2. Using the audio system (Entune Audio)

Device registration/connection flow

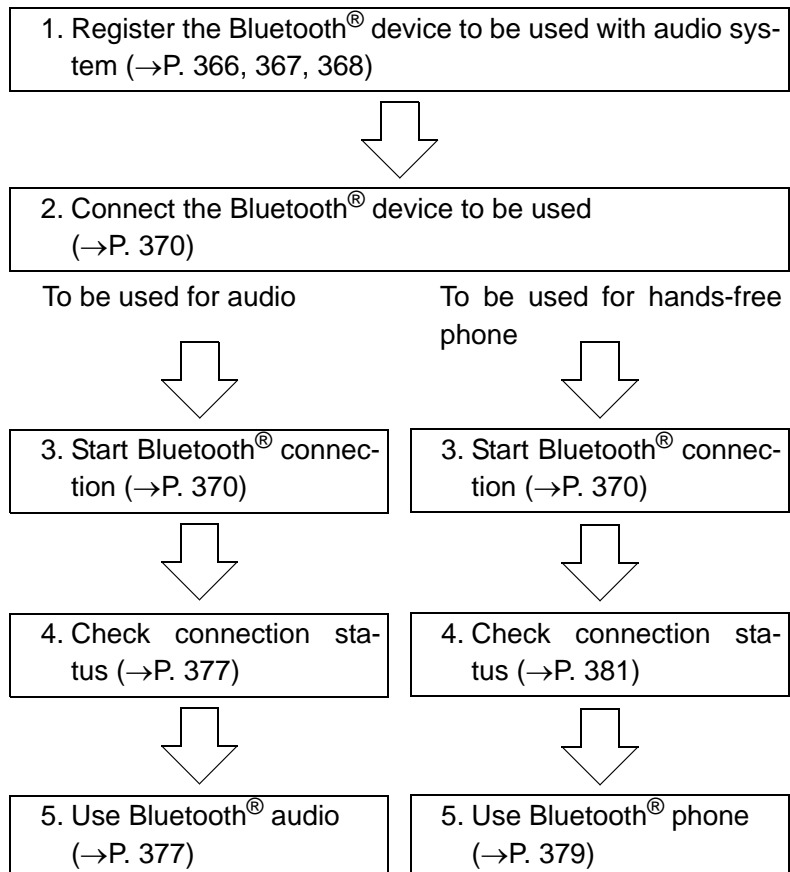

Registering and connecting from the “Bluetooth* Setup” screen

To display the screen shown below, press the “SETUP” button and select “Bluetooth*” on the “Setup” screen.

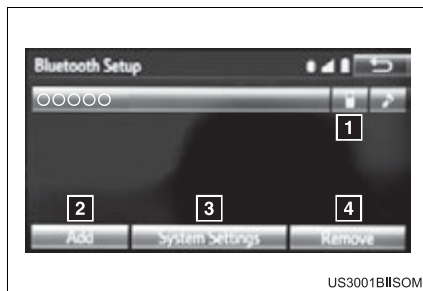

- 1** Select to connect the device to be used with audio system. (→P. 370)
- 2** Select to register a Bluetooth® device to be used with audio system. (→P. 368)
- 3** Select to set detailed Bluetooth® system settings. (→P. 375)
- 4** Select to delete registered devices. (→P. 369)

*: Bluetooth is a registered trademark of Bluetooth SIG, Inc.

3-2. Using the audio system (Entune Audio) Registering a Bluetooth® audio player for the first time

To use the Bluetooth® Audio, it is necessary to register an audio player with the system.

Once the player has been registered, it is possible to use the Bluetooth® Audio.

For details about registering a Bluetooth® device (→P. 368)

- STEP 1** Turn the Bluetooth® connection setting of your audio player on.
- STEP 2** Press the “AUDIO” button.
- STEP 3** Select “ Audio”.
- STEP 4** Select “Select Device”.
- STEP 5** Follow the steps in “How to registering a Bluetooth® device” from **STEP 2**. (→P. 368)

3-2. Using the audio system (Entune Audio) Registering a Bluetooth® phone for the first time

To use the hands-free system, it is necessary to register a Bluetooth® phone with the system.

Once the phone has been registered, it is possible to use the hands-free system.

For details about registering a Bluetooth® device (→P. 368)

- STEP 1** Turn the Bluetooth® connection setting of your cellular phone on.
- STEP 2** Press the “☎” button.
- STEP 3** Select “OK” to register a phone.
- STEP 4** Follow the steps in “How to registering a Bluetooth® device” from **STEP 3**. (→P. 368)

3

Interior features

3-2. Using the audio system (Entune Audio) Registering a Bluetooth® device

Bluetooth® compatible phones (HFP) and portable audio players (AVP) can be registered simultaneously. You can register up to 5 Bluetooth® devices.

How to register a Bluetooth® device

STEP 1 Display the “Bluetooth* Setup” screen. (→P. 365)

*: Bluetooth is a registered trademark of Bluetooth SIG, Inc.

STEP 2 Select “Add”.

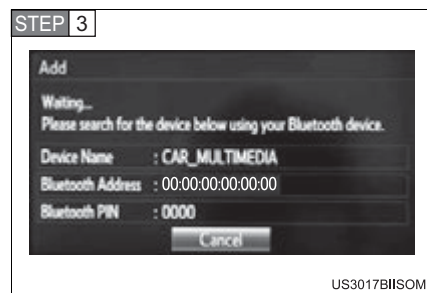

When this screen is displayed, search for the device name displayed on this screen on the screen of your Bluetooth® device.

For details about operating the Bluetooth® device, see the manual that comes with it.

To cancel the registration, select “Cancel”.

STEP 4 Register the Bluetooth® device using your Bluetooth® device.

A PIN-code is not required for SSP (Secure Simple Pairing) compatible Bluetooth® devices. Depending on the type of Bluetooth® device being connected, a message confirming registration may be displayed on the Bluetooth® device's screen. Respond and operate the Bluetooth® device according to the confirmation message.



Check that this screen is displayed when registration is complete.

STEP 6 Select "OK" when the connection status changes from "Connecting..." to "Connected".

If an error message is displayed, follow the guidance on the screen to try again.

Registration can be performed from screens other than the "Bluetooth* Setup" screen.

■ **When registering from the "Bluetooth* Audio" screen**

STEP 1 Display the "Bluetooth* Audio" screen. (→P. 336)

STEP 2 Select "Select Device".

STEP 3 Follow the steps in "How to registering a Bluetooth® device" from **STEP 2**. (→P. 368)

*: Bluetooth is a registered trademark of Bluetooth SIG, Inc.

Deleting a Bluetooth® device

STEP 1 Display the "Bluetooth* Setup" screen. (→P. 365)

*: Bluetooth is a registered trademark of Bluetooth SIG, Inc.

STEP 2 Select "Remove".

STEP 3 Select the desired device.

STEP 4 A confirmation message will be displayed, select "Yes" to delete the device.

STEP 5 Check that a confirmation screen is displayed when the operation is complete.

3-2. Using the audio system (Entune Audio) Connecting a Bluetooth® device

Up to 5 Bluetooth® devices (Phones (HFP) and audio players (AVP)) can be registered.

If more than 1 Bluetooth® device has been registered, select which device to connect to.

STEP 1 Press the “SETUP” button.

STEP 2 Select “Bluetooth*”.

*: Bluetooth is a registered trademark of Bluetooth SIG, Inc.

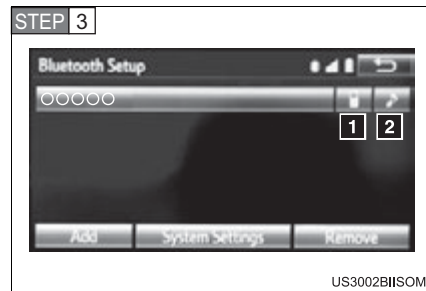

Select the device to be connected.

Supported profile icons will be displayed.

1 Phone

2 Audio player

Supported profile icons for currently connected devices will illuminate.

Dimmed icons can be selected to connect to the function directly.

Auto connection

To turn auto connection mode on, set “Bluetooth* Power” to on.
(→P. 375)

When you register a phone, auto connection will be activated. Always set it to this mode and leave the Bluetooth® phone in a place where a connection can be established.

When the engine switch is turned to the “ACC” or “ON” position (vehicles without a smart key system) or ACCESSORY or IGNITION ON mode (vehicles with a smart key system), the system will search for a nearby cellular phone you have registered.

Next, the system automatically connects with the most recent of the phones connected to in the past. Then, the connection result is displayed.

Manual connection

When auto connection has failed or “Bluetooth* Power” is turned off, you must connect the Bluetooth® device manually.

*: Bluetooth is a registered trademark of Bluetooth SIG, Inc.

STEP 1 Follow the steps in “Connecting a Bluetooth® device” from **STEP 1**. (→P. 370)

Connecting a Bluetooth® audio player

▶ Registering an additional device

STEP 1 Select “Select Device” on the Bluetooth® audio control screen.

STEP 2 For more information: →P. 368

▶ Selecting a registered device

STEP 1 Select “Select Device” on the Bluetooth® audio control screen.

STEP 2 For more information: →P. 370

3-2. Using the audio system (Entune Audio)

■ Reconnecting a Bluetooth® phone

If the system cannot connect due to poor signal strength with the engine switch in the “ACC” or “ON” position (vehicles without a smart key system) or ACCESSORY or IGNITION ON mode (vehicles with a smart key system), the system will automatically attempt to reconnect.

If the phone is turned off, the system will not attempt to reconnect. In this case, the connection must be made manually, or the phone must be reselected.

3-2. Using the audio system (Entune Audio) Displaying a Bluetooth® device details

You can confirm and change the registered device details.

Bluetooth® device registration status

STEP 1 Display the “Bluetooth* Setup” screen. (→P. 365)

*: Bluetooth is a registered trademark of Bluetooth SIG, Inc.

STEP 2 Select the device.

STEP 3 Select “Device Info”.

STEP 4 Following screen is displayed:

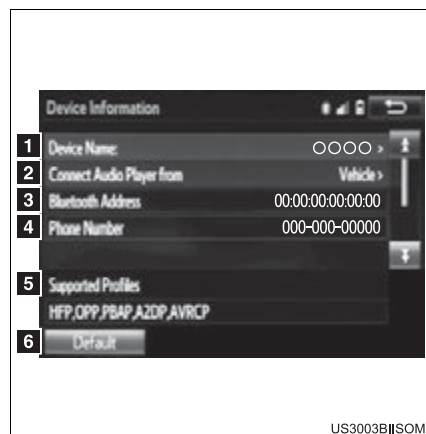

1 Device Name

2 Change connection method (→P. 374)

3 Bluetooth® Address

4 Display your telephone number

The number may not be displayed depending on the model of phone.

5 Compatibility profile of the device

6 Restore default settings

3

Interior features

3-2. Using the audio system (Entune Audio)

Changing connection method

STEP 1 Select "Connect Audio Player from".

STEP 2 Select "Vehicle" or "Device".

"Vehicle": Connect the audio system to the portable audio player.

"Device": Connect the portable audio player to the audio system

3-2. Using the audio system (Entune Audio) Detailed Bluetooth® system settings

You can confirm and change the detailed Bluetooth® settings.

How to check and change detailed Bluetooth® settings

STEP 1 Display the “Bluetooth* Setup” screen. (→P. 365)

STEP 2 Select “System Settings”.

STEP 3 The following screen is displayed:

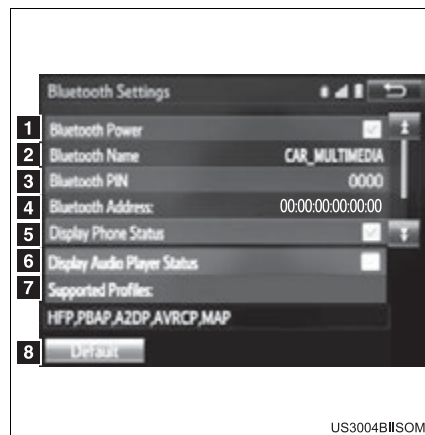

1 Bluetooth® Power on/off

You can change Bluetooth® function on/off

2 Bluetooth® Name

3 Change PIN-code (→P. 376)

4 Bluetooth® Address

5 Display Phone Status

You can set the system to show the status confirmation display when connecting a telephone

6 Display Audio Player Status

You can set the system to show the status confirmation display when connecting an audio player

7 Compatibility profile of the system

8 Restore default settings

*: Bluetooth is a registered trademark of Bluetooth SIG, Inc.

3

Interior features

3-2. Using the audio system (Entune Audio)

Editing the Bluetooth* PIN

You can change the PIN-code that is used to register your Bluetooth® devices in the system.

STEP 1 Select “Bluetooth* PIN”.

STEP 2 Input a PIN-code, and select “OK”.

*: Bluetooth is a registered trademark of Bluetooth SIG, Inc.

3-2. Using the audio system (Entune Audio) Listening to Bluetooth® Audio

The Bluetooth® audio system enables the user to enjoy music played on a portable player from the vehicle speakers via wireless communication.

When a Bluetooth® device cannot be connected, check the connection status on the “Bluetooth* Audio” screen. If the device is not connected, either register or reconnect the device. (→P. 370)

*: Bluetooth is a registered trademark of Bluetooth SIG, Inc.

Status display







You can check such indicators as signal strength and battery charge on the screen.



1 Battery charge

The battery charge indicator may not be displayed depending on the connected device.

2 Connection status

Indicators	Conditions
Battery charge	Full ←————→ Empty   
Connection status	Good ←————→ Not connected   

3

Interior features

3-2. Using the audio system (Entune Audio)

Playing Bluetooth® audio

Select  or  to Play/Pause.

For details on “Bluetooth* Audio” screen operation methods, refer to Basic Audio Operations. (→P. 326)

For details on how to select a track or album, refer to selecting, fast-forwarding and reversing tracks/files/songs. (→P. 338)

*: Bluetooth is a registered trademark of Bluetooth SIG, Inc.

3-2. Using the audio system (Entune Audio) Using a Bluetooth® Phone



The hands-free system is a function that allows you to use your cellular phone without touching it.

This system supports Bluetooth®. Bluetooth® is a wireless data system that allows the cellular phone to wirelessly connect to the hands-free system and make/receive calls.

Before making a phone call, check the connection status, battery charge, call area and signal strength. (→P. 381)

If a Bluetooth® device cannot be connected, check the connection status on the phone screen. If the device is not connected, either register or reconnect it. (→P. 370)

Phone screen

To display the screen shown below, press the  switch on the steering wheel or the  button.

Several functions are available to operate on each screen that is displayed by selecting the 4 tabs.

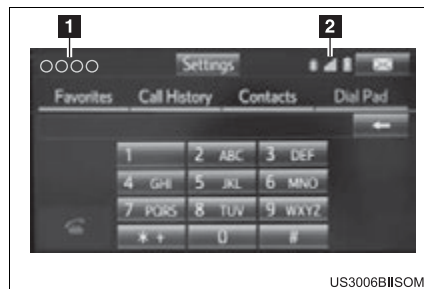

1 Device name

2 Bluetooth® connection status

3-2. Using the audio system (Entune Audio)

■ Telephone switch (→P. 396)

■ Microphone

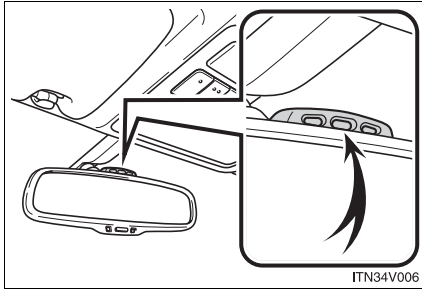

The vehicle's built in microphone is used when talking on the phone.

The person you are speaking to can be heard from the front speakers.

To use the hands-free system, you must register your Bluetooth® phone in the system. (→P. 368)

Status display

You can check indicators such as signal strength and battery charge on the phone screen.



- 1** Connection status
- 2** Signal strength
- 3** Battery charge



Indicators	Conditions
Connection status	Good (Blue) ↔ Poor (Gray) ↔ Not connected
Battery charge	Full ↔ Empty
Signal strength	Excellent ↔ Poor

3-2. Using the audio system (Entune Audio)

Making a call



Once a Bluetooth® phone is registered, you can make a call using the following procedure:

Dialing

- STEP 1** Display the phone screen. (→P. 379)
- STEP 2** Select the “Dial Pad” tab and enter a phone number.
To delete the input phone number, select .
For the first digit, you can enter “+” by selecting “*” for a while.
- STEP 3** Press the  switch on the steering wheel or select .

Dialing from the contacts list

You can dial a number from the contact data imported from your cellular phone. The system has one contact for each registered phone. Up to 2500 contacts may be stored in each contact.

- STEP 1** Display the phone screen. (→P. 379)
- STEP 2** Select “Contacts” tab.
- STEP 3** Choose the desired contact to call from the list.
- STEP 4** Choose the number and then press the  switch on the steering wheel or select .

When the contact is empty

You can transfer the phone numbers in a Bluetooth® phone to the system.

Operation methods differ between PBAP (Phone Book Access Profile) compatible and PBAP incompatible Bluetooth® phones. If the cellular phone does not support either PBAP or OPP (Object Push Profile) service, you cannot transfer contacts.

■ **For PBAP compatible Bluetooth® phones**

▶ When “Automatic Contact/History Transfer” is set to off

STEP 1 Select the desired item.

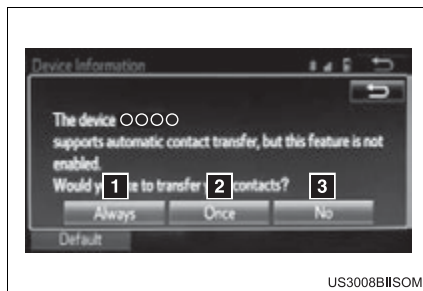

- 1** Select to transfer new contacts from a cellular phone, select “Always” and then enable “Automatic Contact/History Transfer”.
- 2** Select to transfer all the contacts from a connected cellular phone only once.
- 3** Select to cancel transferring.

■ **For PBAP incompatible but OPP compatible Bluetooth® phones**

STEP 1 Select the desired item.



- 1** Select to transfer the contacts from the connected cellular phone.
- 2** Select to add a new contact manually.
- 3** Select to cancel transferring.

▶ When “Transfer” is selected

STEP 2 Follow the steps in “Update contacts from phone” from **STEP 2**. (→P. 402)

▶ When “Add” is selected

STEP 2 Follow the steps in “Registering a new contact to the contacts list” from **STEP 2**. (→P. 403)

3-2. Using the audio system (Entune Audio)

Calling using favorites list

You can make a call using numbers registered in the contact.

STEP 1 Display the phone screen. (→P. 379)

STEP 2 Select “Favorites” tab.

STEP 3 Select the desired number to make a call.

Dialing from call history

You can make a call using the call history, which has the 3 functions below.

 : calls which you missed

 : calls which you received

 : calls which you made

STEP 1 Display the phone screen. (→P. 379)

STEP 2 Select “Call History” tab.

STEP 3 Select  or the desired entry from the list.

▶ When  is selected

STEP 4 Check that the “Call” screen is displayed.

▶ When the desired contact is selected

STEP 4 Select the desired number.

STEP 5 Check that the “Call” screen is displayed.

■ **Call history list**

- If you make a call to or receive a call from a number registered in the contact, the name is displayed in the call history.
- If you make multiple calls to the same number, only the last call made is displayed in the call history.

■ **International calls**



You may not be able to make international calls, depending on the mobile phone in use.

3-2. Using the audio system (Entune Audio) Receiving a call

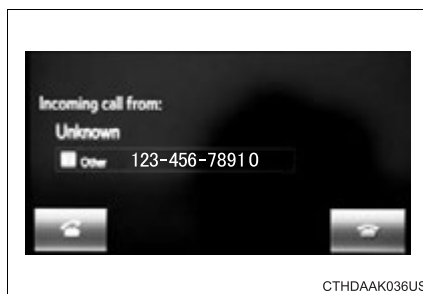

When a call is received, the following screen is displayed together with a sound.

To answer the phone



Press the  switch on the steering wheel or select .

To refuse a call

Press the  switch on the steering wheel or select .

To adjust the incoming call volume

Turn the "PWR VOL" knob. You can also adjust the volume using the steering switches.

■ International calls

Received international calls may not be displayed correctly depending on the cellular phone in use.

3-2. Using the audio system (Entune Audio) Speaking on the phone

The following screen is displayed when speaking on the phone.



To adjust the call volume

Select “-” or “+”. You can also adjust the volume using the steering switches or the volume knob.

To prevent the other party from hearing your voice

Select “Mute”.

Inputting tones

When using phone services such as an answering service or a bank, you can store phone numbers and code numbers in the contact.

STEP 1 Select “0-9”.

STEP 2 Input the number.

■ Release Tones

“Release Tones” appear when a continuous tone signal(s) containing a (w) is registered in the contact list.

STEP 1 Select “Release Tones”.

■ **Release Tones**

- A continuous tone signal is a character string that consists of numbers and the characters p or w. (e.g.056133w0123p#1*)
- When the “p” pause tone is used, the tone data up until the next pause tone will be automatically sent after 2 seconds have elapsed. When the “w” pause tone is used, the tone data up until the next pause tone will be automatically sent after a user operation is performed.
- Release tones can be used when automated operation of a phone based service such as an answering machine or bank phone service is desired. A phone number with continuous tone signals can be registered in the contact list.
- Tone data after a “w” pause tone can be operated on voice command during a call.

To transfer a call

Select “Handset Mode” to on from a hands-free call to a cellular phone call.

Select “Handset Mode” to off from a cellular phone call to a hands-free call.



Transmit volume setting

STEP 1 Select “Transmit Volume”.

STEP 2 Select the desired level for the transmit volume.

STEP 3 Select “OK”.

To hang up



Press the  switch on the steering wheel or select .

Call waiting

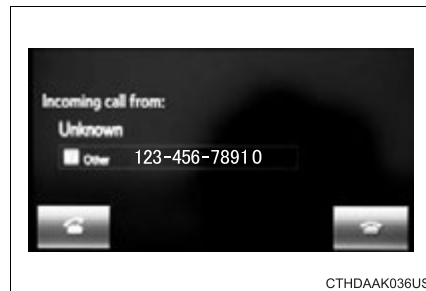

When a call is interrupted by a third party while talking, an incoming call message will be displayed.





To talk with the other party:

- Press the  switch on the steering wheel.
- Select .

To refuse the call:

- Press the  switch on the steering wheel.
- Select .

Every time you press the  switch on the steering wheel or select  during call waiting, you will be switched to the other party.

3-2. Using the audio system (Entune Audio)

■ Transferring calls

- If you transfer from the cellular phone to hands-free, the hands-free screen will be displayed, and you can operate the system using the screen.
- Transfer method and operation may vary according to the cellular phone used.
- For operation of the cellular phone in use, see the phone's manual.

■ Call waiting operation

Call waiting operation may differ depending on your phone company and cellular phone.

3-2. Using the audio system (Entune Audio) Bluetooth® phone message function

Received messages can be forwarded from the connected Bluetooth® phone, enabling checking and replying using the audio system.

Depending on the type of Bluetooth® phone connected, received messages may not be transferred to the message inbox.

If the phone does not support the message function, this function cannot be used.

Displaying “Message Inbox” screen

STEP 1 Press the  button.

STEP 2 Select .

Receiving a message

When an e-mail/SMS/MMS is received, the incoming message screen pops up with sound and is ready to be operated on the screen.



- 1** Select to check the message.
- 2** Select to refuse the message.
- 3** Select to call the message sender.

■ **Receiving a message**

- Depending on the cellular phone used for receiving messages, or its registration status with the navigation system, some information may not be displayed.
- The pop up screen is separately available for incoming e-mail and SMS/MMS messages under the following conditions:
 - E-mail:
 - “Incoming E-mail Display” is set to “Full Screen”. (→P. 408)
 - “E-mail Notification Popup” is set to on. (→P. 408)
 - SMS/MMS:
 - “Incoming SMS/MMS Display” is set to “Full screen”. (→P. 408)
 - “SMS/MMS Notification Popup” is set to on. (→P. 408)

Checking the messages

STEP 1 Display the “Message Inbox” screen. (→P. 391)

STEP 2 Select the desired message from the list.

STEP 3 Check that the message is displayed.

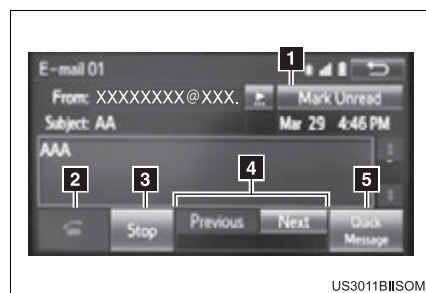

1 E-mails: Select “Mark Unread” or “Mark Read” to mark mail unread or read on the message inbox screen.

This function is available when “Update Read Status on Phone” is set to on (→P. 408)

2 Select to make a call to the sender.

3 Select to have messages read out. To cancel this function, select “Stop”.

4 Select to display the previous or next message.

5 Select to reply the message.

■ Check the messages

- Depending on the type of Bluetooth® phone being connected, it may be necessary to perform additional steps on the phone.
- Messages are displayed in the appropriate connected Bluetooth® phone's registered mail address folder.
Select the tab of the desired folder to be displayed.
- Only received messages on the connected Bluetooth® phone can be displayed.
- The text of the message is not displayed while driving.
- When "Automatic Message Readout" is set to on, messages will be automatically read out. (→P. 408)
- Turn the "PWR VOL" knob, or use the volume switch on the steering wheel to adjust the message read out volume.
- The message read out function is available even while driving.

Replying to a message

STEP 1 Display the "Message Inbox" screen. (→P. 391)

STEP 2 Select the desired message from the list.

STEP 3 Select "Quick Message".

STEP 4 Select the desired message.

STEP 5 Select "Send".

If an error message is displayed, follow the guidance on the screen to try again.

■ Editing quick reply message

STEP 1 Select "Quick Message".

STEP 2 Select  corresponding to the desired message to edit.

STEP 3 Select "OK" when editing is completed.

Calling the message sender

Calls can be made to an e-mail/SMS/MMS message sender's phone number.

STEP 1 Display the "Message Inbox" screen. (→P. 391)

STEP 2 Select the desired message.

STEP 3 Select .

STEP 4 Check that the "Call" screen is displayed.

■ Calling from a number within a message

Calls can be made to a number identified in a message's text area.

This operation cannot be performed while driving.

STEP 1 Display the "Message Inbox" screen. (→P. 391)

STEP 2 Select the desired message.

STEP 3 Select the text area.

STEP 4 Select  corresponding to the desired number.

STEP 5 Check that the "Call" screen is displayed.

■ Calling from the incoming message screen

→P. 389

3-2. Using the audio system (Entune Audio) Using the steering wheel switches

The steering wheel switches can be used to operate a connected cellular phone.

Operating a telephone using the steering wheel switches

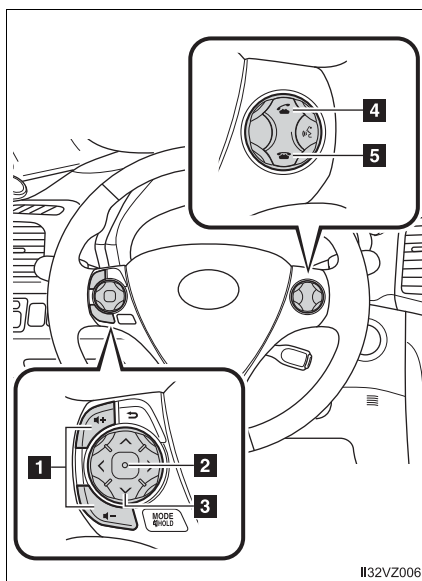

- 1** Volume switch
 - Increase/Decrease the volume
 - Press and hold:
Continuously increase/decrease the volume
- 2** Enter switch
 - Select an item
- 3** Cursor switch
 - Select a list/tab
- 4** Off hook switch
 - Make a call
 - Receive a call
 - Display "Phone" screen
- 5** On hook switch
 - End a call
 - Refuse a call

3-2. Using the audio system (Entune Audio) Bluetooth® phone settings

You can adjust the hands-free system to your desired settings.

“Phone/Message Settings” screen

To display the screen shown below, press the “SETUP” button, and select “Phone” on the “Setup” screen.

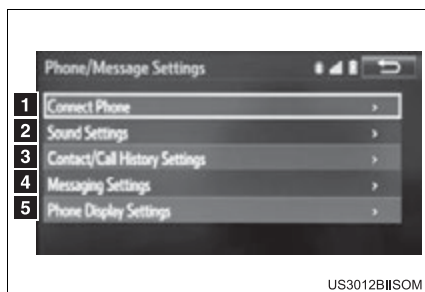

- 1** Set the phone connection (→P. 368)
- 2** Setting the sound (→P. 398)
- 3** Contact/Call History Settings (→P. 399)
- 4** Set the message settings (→P. 408)
- 5** Set the phone display (→P. 410)

3

Interior features

3-2. Using the audio system (Entune Audio)

Sound setting

STEP 1 Display the “Phone/Message Settings” screen. (→P. 397)

STEP 2 Select “Sound Settings” on the “Phone/Message Settings” screen.

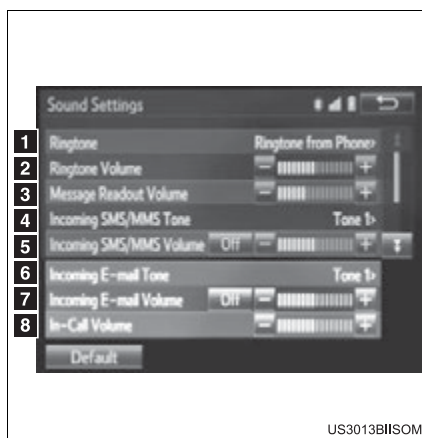

- 1** Set the desired ringtone.
- 2** Adjust the ringtone volume.
- 3** Adjust the message readout volume.
- 4** Set the desired incoming SMS/MMS tone.
- 5** Adjust the incoming SMS/MMS tone volume.
- 6** Set the incoming e-mail tone.
- 7** Adjust the incoming e-mail tone volume.
- 8** Adjust the default volume of the other party's voice.

■ To return to the default settings

Select “Default”, and then “Yes”.

3-2. Using the audio system (Entune Audio) Contact/Call History Settings

The contact can be transferred from a Bluetooth® phone to the system. The contact also can be added, edited and deleted.

The call history can be deleted and contact and favorites can be changed.

STEP 1 Display the “Phone/Message Settings” screen. (→P. 397)

STEP 2 Select “Contact/Call History Settings”.

3-2. Using the audio system (Entune Audio)

STEP 3 Select the desired item to be set.



1 For PBAP compatible Bluetooth® phones, select to set automatic contact/history transfer on/off. When set to on, the phone's contact data and history are automatically transferred.

2 Select to update contacts from the connected phone. (→P. 401)

3 Select to sort contacts by the first name or last name field.

4 Select to add contacts to the favorites list. (→P. 405)

5 Select to delete contacts from the favorites list. (→P. 407)

6 Select to clear contacts from the call history.*

7 Select to add new contacts to the contact list.* (→P. 403)

8 Select to edit contacts in the contact list.* (→P. 404)

9 Select to delete contacts from the contact list.* (→P. 405)

10 Select to reset all setup items.

*: For PBAP compatible Bluetooth® phones only, this function is available when "Automatic Contact/History Transfer" is set to off. (→P. 399)

Update contacts from phone

Operation methods differ between PBAP compatible and PBAP incompatible but OPP compatible Bluetooth® phones.

If your cellular phone is neither PBAP nor OPP compatible, the contacts cannot be transferred.

■ For PBAP compatible Bluetooth® Phones

STEP 1 Select "Update Contacts from Phone".

STEP 2 Check that a confirmation screen is displayed when the operation is complete.

This operation may be unnecessary depending on the type of cellular phone.

Depending on the type of cellular phone, OBEX authentication may be required when transferring contact data. Enter "1234" into the Bluetooth® phone.

If another Bluetooth® device is connected when transferring contact data, depending on the phone, the connected Bluetooth® device may need to be disconnected.

Depending on the type of Bluetooth® phone being connected, it may be necessary to perform additional steps on the phone.

■ **For PBAP incompatible but OPP compatible Bluetooth® Phones**

STEP 1 Select "Update Contacts from Phone".

STEP 2 Transfer the contact data to the system using a Bluetooth® phone.

This operation may be unnecessary depending on the type of cellular phone.

Depending on the type of cellular phone, OBEX authentication may be required when transferring contact data. Enter "1234" into the Bluetooth® phone.

To cancel this function, select "Cancel".

STEP 3 Select "Done" when it appears on the screen.

STEP 4 Check that a confirmation screen is displayed when the operation is complete.

■ **Updating the contacts in a different way (From the "Call History" screen)**

For PBAP compatible Bluetooth® phones, this function is available when "Automatic Contact/History Transfer" is set to off. (→P. 399)

STEP 1 Display the phone screen. (→P. 379)

STEP 2 Select the "Call History" tab and select a contact not yet registered in the contact list.

STEP 3 Select "Update Contact".

STEP 4 Select the desired contact.

STEP 5 Select a phone type for the phone number.

Registering a new contact to the contact list

New contact data can be registered. Up to 4 numbers per person can be registered. For PBAP compatible Bluetooth® phones, this function is available when “Automatic Contact/History Transfer” is set to off. (→P. 399)

STEP 1 Select “New Contact”.

STEP 2 Enter the name and select “OK”.

STEP 3 Enter the phone number and select “OK”.

STEP 4 Select the phone type for the phone number.

STEP 5 To add another number to this contact, select “Yes”.

■ Registering a new contact in a different way (From the “Call History” screen)

STEP 1 Display the phone screen. (→P. 379)

STEP 2 Select the “Call History” tab and select a contact not yet registered in the contact list.

STEP 3 Select “Add to Contacts”.

STEP 4 Follow the steps in “Registering a new contact to the contacts list” from **STEP 3**. (→P. 403)

Editing the contact data

For PBAP compatible Bluetooth® phones, this function is available when “Automatic Contact/History Transfer” is set to off. (→P. 399)

STEP 1 Select “Edit Contact”.

STEP 2 Select the desired contact.

STEP 3 Select  corresponding to the desired name or number.

► For editing the name

STEP 4 Follow the steps in “Registering a new contact to the contacts list” from **STEP 2**. (→P. 403)

► For editing the number

STEP 4 Follow the steps in “Registering a new contact to the contacts list” from **STEP 3**. (→P. 403)

■ Editing the contacts in a different way (From the “Contact Details” screen)

STEP 1 Display the phone screen. (→P. 379)

STEP 2 Select the “Contacts”, “Call History” tab or the “Favorites” tab and select the desired contact.

STEP 3 Select “Edit Contact”.

“E-mail Addresses”: Select to display all registered e-mail addresses for the contact.

STEP 4 Follow the steps in “Editing the contact data” from **STEP 4**. (→P. 404)

Deleting the contact data

For PBAP compatible Bluetooth® phones, this function is available when “Automatic Contact/History Transfer” is set to off. (→P. 399)

STEP 1 Select “Delete Contacts”.

STEP 2 Select the desired contact and select “Delete”.

STEP 3 Select “Yes” when the confirmation screen appears.

■ Deleting the contact in a different way (From the “Contact Details” screen)

STEP 1 Display the phone screen. (→P. 379)

STEP 2 Select the “Contacts”, “Call history” tab or the “Favorites” tab and select the desired contact.

STEP 3 Select “Edit Contact”.

STEP 4 Select “Yes” when the confirmation screen appears.

Favorites list setting

Up to 15 contacts (maximum of 4 numbers per contact) can be registered in the favorites list.

■ Registering the contacts in the favorites list

STEP 1 Select “Add Favorite”.

STEP 2 Select the desired contact to add to the favorites list.

Dimmed contacts are already stored as a favorite.

STEP 3 Check that a confirmation screen is displayed when the operation is complete.

3-2. Using the audio system (Entune Audio)

- ▶ When 15 contacts have already been registered to the favorites list

STEP 1 When 15 contacts have already been registered to the favorites list, a registered contact needs to be replaced.

Select “Yes” when the confirmation screen appears to replace a contact.

STEP 2 Select the contact to be replaced.

STEP 3 Check that a confirmation screen is displayed when the operation is complete.

- ▶ Registering contacts in the favorites list in a different way (from the “Contacts” screen)

STEP 1 Display the phone screen. (→P. 379)

STEP 2 Select the “Contacts” tab.

STEP 3 Select ☆ at the beginning of the desired contact list name to be registered in the favorites list.

When selected, ☆ is changed to ★, and the contact is registered in the favorites list.

- ▶ Registering contacts in the favorites list in a different way (from the “Contact Details” screen)

STEP 1 Display the phone screen. (→P. 379)

STEP 2 Select the “Contacts” tab or the “Call History” tab and select the desired contact.

STEP 3 Select “Add Favorite”.

STEP 4 Check that a confirmation screen is displayed when the operation is complete.

■ **Deleting the contacts in the favorites list**

STEP 1 Select "Remove Favorite".

STEP 2 Select the desired contacts and select "Remove".

STEP 3 Select "Yes" when the confirmation screen appears.

STEP 4 Check that a confirmation screen is displayed when the operation is complete.

▶ Deleting contacts in the favorites list in a different way (from the "Contacts" screen)

STEP 1 Display the phone screen. (→P. 379)

STEP 2 Select the "Contacts" tab.

STEP 3 Select ★ at the beginning of the contact list name to be deleted from the favorites. list.

When selected, ★ is changed to ☆, and the data is deleted from the list.

▶ Deleting contacts in the favorites list in a different way (from the "Contact Details" screen)

STEP 1 Display the phone screen. (→P. 379)

STEP 2 Select the "Contacts", "Call History" tab or the "Favorites" tab and select the desired contact to delete.

STEP 3 Select "Remove Favorite".

STEP 4 Select "Yes" when the confirmation screen appears.

STEP 5 Check that a confirmation screen is displayed when the operation is complete.

3-2. Using the audio system (Entune Audio)

Message Settings

STEP 1 Display the “Phone/Message Settings” screen. (→P. 397)

STEP 2 Select “Messaging Settings”.

STEP 3 Select the desired item to be set.

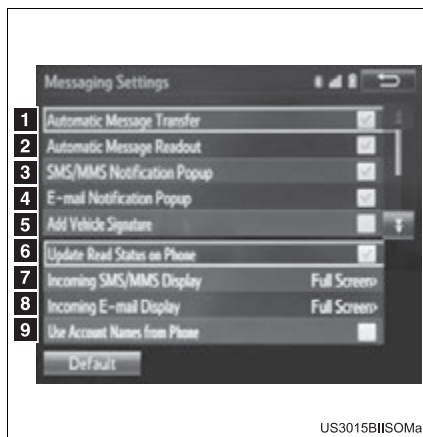

1 Set automatic message transfer on/off.

2 Set automatic message readout on/off.

3 Set the SMS/MMS notification popup on/off.

4 Set the e-mail notification popup on/off.

5 Set adding the vehicle signature to outgoing messages on/off.

6 Set updating message read status on phone on/off.

7 Change the incoming SMS/MMS display.

“Full Screen”: When an SMS/MMS message is received, the incoming SMS/MMS display screen is displayed and can be operated on the screen.

“Drop-Down”: When an SMS/MMS message is received, a message is displayed on the upper side of the screen.

8 Change the incoming e-mail display.

“Full Screen”: When an e-mail is received, the incoming e-mail display screen is the displayed and can be operated on the screen.

“Drop-Down”: When an e-mail is received, a message is displayed on the upper side of the screen.

9 Set display of messaging account names on the inbox tab on/off.

When set to on, messaging account names used on the cellular phone will be displayed.

■ **To return to the default settings**

Select “Default”, and then “Yes”.

3-2. Using the audio system (Entune Audio)

■ Displaying the “Messaging Settings” screen in a different way

STEP 1 Display the phone screen. (→P. 379)

STEP 2 Select .

STEP 3 Select “Settings”.

STEP 4 Select “Message Settings”.

Phone Display Settings

STEP 1 Display the “Phone/Message Settings” screen. (→P. 397)

STEP 2 Select “Phone Display Settings”.

STEP 3 Select the desired item to be set.



1 Change the incoming call display.

“Full Screen”: When a call is received, the hands-free screen is displayed and can be operated on the screen.

“Drop-Down”: A message is displayed on the upper side of the screen.

2 Set display of the contact/ history transfer completion message on/off.

■ To return to the default settings

Select “Default”, and then “Yes”.

3-2. Using the audio system (Entune Audio) What to do if... (Troubleshooting)

If there is a problem with the hands-free system or a Bluetooth® device, first check the table below.

► When using the hands-free system with a Bluetooth® device

Symptom	Likely cause	Solution	Page	
			Cellular phone	This system
The hands-free system or Bluetooth® device does not work.	The connected device may not be a compatible Bluetooth® cellular phone.	For a list of specific devices which operation has been confirmed on this system, check with your Toyota dealer or the web-site.*1	*2	—
	The Bluetooth version of the connected cellular phone may be older than the specified version.	Use a cellular phone with Bluetooth version 1.1 or higher (recommended: Ver.3.0 + EDR or higher).	*2	P. 419

3

Interior features

3-2. Using the audio system (Entune Audio)

► When registering/connecting a cellular phone

Symptom	Likely cause	Solution	Page	
			Cellular phone	This system
A cellular phone cannot be registered.	An incorrect passcode was entered on the cellular phone.	Enter the correct passcode on the cellular phone.	*2	—
	The registration operation has not been completed on the cellular phone side.	Complete the registration operation on the cellular phone (approve registration on the phone).	*2	—
	Old registration information remains on either this system or the cellular phone.	Delete the existing registration information from both this system and the cellular phone, then register the cellular phone you wish to connect to this system.	*2	P. 369

3-2. Using the audio system (Entune Audio)

Symptom	Likely cause	Solution	Page	
			Cellular phone	This system
A Bluetooth® connection cannot be made.	Another Bluetooth® device is already connected.	Manually connect the cellular phone you wish to use to this system.	—	P. 371
	Bluetooth® function is not enabled on the cellular phone.	Enable the Bluetooth® function on the cellular phone.	*2	—
	Automatic Bluetooth® connection on this system is set to off.	Set automatic Bluetooth® connection on this system to on when the engine switch is turned to the “ACC” or “ON” position (vehicles without a smart key system) or ACCESSORY or IGNITION ON mode (vehicles with a smart key system).	—	P. 371

3-2. Using the audio system (Entune Audio)

Symptom	Likely cause	Solution	Page	
			Cellular phone	This system
"Please check your device settings." message is displayed.	Bluetooth® function is not enabled on the cellular phone.	Enable the Bluetooth® function on the cellular phone.	*2	—
	Old registration information remains on either this system or the cellular phone.	Delete the existing registration information from both this system and the cellular phone, then register the cellular phone you wish to connect to this system.	*2	P. 369

► When making/receiving a call

Symptom	Likely cause	Solution	Page	
			Cellular phone	This system
A call cannot be made/received.	Your vehicle is in a "Out of cellular service area. Please try again later." area.	Move to where "Out of cellular service area. Please try again later." no longer appears on the display.	—	—

► When using the contact list

Symptom	Likely cause	Solution	Page	
			Cellular phone	This system
Contact data cannot be transferred manually/automatically.	The profile version of the connected cellular phone may not be compatible with transferring contact data.	For a list of specific devices which operation has been confirmed on this system, check with your Toyota dealer or the website.*1	*2	—
	Automatic contact transfer function on this system is set to off.	Set automatic contact transfer function on this system to on.	—	P. 399
	Passcode has not been entered on the cellular phone.	Enter the passcode on the cellular phone if requested (default passcode: 1234).	*2	—
	Transfer operation on the cellular phone has not completed.	Complete transfer operation on the cellular phone (approve transfer operation on the phone)	*2	—
Contact data cannot be edited.	Automatic contact transfer function on this system is set to on.	Set automatic contact transfer function on this system to off.	—	P. 399

3-2. Using the audio system (Entune Audio)

► When using the Bluetooth® message function (if equipped)

Symptom	Likely cause	Solution	Page	
			Cellular phone	This system
Messages cannot be viewed.	Message transfer is not enabled on the cellular phone.	Enable message transfer on the cellular phone (approve message transfer on the phone).	*2	—
	Automatic transfer function on this system is set to off.	Set automatic transfer function on this system to on.	—	P. 408
New message notifications are not displayed.	Notification of SMS/MMS/e-mail reception on this system is set to off.	Set notification of SMS/MMS/e-mail reception on this system to on.	*2	P. 408
	Automatic message transfer function is not enabled on the cellular phone.	Enable automatic transfer function on the cellular phone.	*2	P. 408

3-2. Using the audio system (Entune Audio)

► In other situations

Symptom	Likely cause	Solution	Page	
			Cellular phone	This system
The Bluetooth® connection status is displayed at the top of the screen each time the engine switch is turned to the “ACC” or “ON” position (vehicles without a smart key system) or ACCESSORY or IGNITION ON mode (vehicles with a smart key system).	Connection confirmation display on this system is set to on.	To turn off the display, set connection confirmation display on this system to off.	—	P. 375

3-2. Using the audio system (Entune Audio)

Symptom	Likely cause	Solution	Page	
			Cellular phone	This system
Even though all conceivable measures have been taken, the symptom status does not change.	The cellular phone is not close enough to this system.	Bring the cellular phone closer to this system.	—	—
	The cellular phone is the most likely cause of the symptom.	Turn the cellular phone off, remove and reinstall the battery pack, and then restart the cellular phone.	*2	—
		Enable the cellular phone's Bluetooth® connection.	*2	—
		Stop the cellular phone's security software and close all applications.	*2	—
		Before using an application installed on the cellular phone, carefully check its source and how its operation might affect this system.	*2	—

*1: <http://www.toyota.com/entune/>

*2: For details, refer to the owner's manual that came with the cellular phone.

3-2. Using the audio system (Entune Audio) Bluetooth®

■ When using the Bluetooth® audio system

- In the following conditions, the system may not function.
 - If the portable audio player is turned off
 - If the portable audio player is not connected
 - If the portable audio player's battery is low
- There may be a delay if a cellular phone connection is made during Bluetooth® audio play.
- Depending on the type of portable audio player that is connected to the system, operation may differ slightly and certain functions may not be available.

■ When using the hands-free system

- The audio system is muted when making a call.
- If both parties speak at the same time, it may be difficult to hear.
- If the received call volume is overly loud, an echo may be heard.
If the Bluetooth® phone is too close to the system, quality of the sound may deteriorate and connection status may deteriorate.
- In the following circumstances, it may be difficult to hear the other party:
 - When driving on unpaved roads
 - When driving at high speeds
 - If a roof or window is open
 - If the air conditioning is blowing directly on the microphone
 - If there is interference from the network of the cellular phone

3-2. Using the audio system (Entune Audio)

■ Conditions under which the system will not operate

- If using a cellular phone that does not support Bluetooth®
- If the cellular phone is turned off
- If you are outside of cellular phone service coverage
- If the cellular phone is not connected
- If the cellular phone's battery is low
- When outgoing calls are controlled, due to heavy traffic on telephone lines, etc.
- When the cellular phone itself cannot be used
- When transferring contact data from the cellular phone

■ Bluetooth® antenna

The antenna is built into the display.

If the portable audio player is behind the seat or in the glove box or console box, or is touching or covered by metal objects, the connection status may deteriorate.

If the cellular phone is behind the seat or in the console box, or touching or covered by metal objects, the connection status may deteriorate.

■ Battery charge/signal status

- This display may not correspond exactly with the portable audio player or cellular phone itself.
- This system does not have a charging function.
- The portable audio player or cellular phone battery will be depleted quickly when the device is connected to Bluetooth®.

■ **When using the Bluetooth® audio and hands-free system at the same time**

The following problems may occur.

- The Bluetooth® audio connection may be interrupted.
- Noise may be heard during Bluetooth® audio playback.

■ **About the contact in this system**

The following data is stored for every registered cellular phone. When another phone is connecting, you cannot read the registered data.

- Contact data
- Call history
- Favorite

When removing a Bluetooth® phone from the system, the above-mentioned data is also deleted.

■ **About Bluetooth®**



Bluetooth is a registered trademark of Bluetooth SIG, Inc.

The Bluetooth word mark and logos are owned by the Bluetooth SIG, Inc. and any use of such marks by Panasonic Corporation is under license.

Other trademarks and trade names are those of their respective owners.

3-2. Using the audio system (Entune Audio)

■ Compatible models

The Bluetooth® audio system supports portable audio players with the following specifications

- Bluetooth® specifications:

- Ver. 1.1, or higher (Recommended: Ver. 3.0+EDR or higher)

- Profiles:

- A2DP (Advanced Audio Distribution Profile) Ver. 1.0, or higher (Recommended: Ver. 1.2 or higher)
This is a profile to transmit stereo audio to the audio system.
 - AVRCP (Audio/Video Remote Control Profile) Ver. 1.0 or higher (Recommended: Ver. 1.4 or higher)
This is a profile to allow remote control the A/V equipment.

However, please note that some functions may be limited depending on the type of portable audio player connected.

The hands-free system supports cellular phones with the following specifications.

- Bluetooth® specification:

- Ver. 1.1 or higher (Recommended: Ver. 3.0+EDR or higher)

- Profiles:

- HFP (Hands Free Profile) Ver. 1.0 or higher (Recommended: Ver. 1.6 or higher)
This is a profile to allow hands-free phone calls using a cellular phone or head set. It has outgoing and incoming call functions.
 - OPP (Object Push Profile) Ver. 1.1 or higher (Recommended: Ver. 1.2)
This is a profile to transfer contact data. When a Bluetooth® compatible cellular phone has both PBAP and OPP, OPP cannot be used.
 - PBAP (Phone Book Access Profile) Ver. 1.0 or higher (Recommended: Ver. 1.1)
This is a profile to transfer contact data.
 - MAP (Message Access Profile) Ver. 1.0 or higher

If the cellular phone does not support HFP, you cannot register it with the hands-free system.

■ Certification

► For vehicles sold in the U.S.A., Hawaii, Guam and Puerto Rico

FCC ID:ACJ932YEAP01A446

This device complies with Part 15 of the FCC Rules. Operation is subject to the following two conditions: (1) this device may not cause harmful interference, and (2) this device must accept any interference received, including interference that may cause undesired operation.

Changes or modifications not expressly approved by the party responsible for compliance could void the user's authority to operate the equipment.

Radiofrequency radiation exposure information:

This equipment complies with FCC radiation exposure limits set forth for an uncontrolled environment.

This equipment should be installed and operated with minimum distance of 20cm between the radiator and your body.

This transmitter must not be co-located or operating in conjunction with any other antenna or transmitter.

FCC Warning :

Any unauthorized changes or modifications to this equipment would void the user's authority to operate this device.

► For vehicles sold in Canada

IC:216J-YEAP01A466

This device complies with Industry Canada licence-exempt RSS standard(s). Operation is subject to the following two conditions: (1) this device may not cause interference, and (2) this device must accept any interference, including interference that may cause undesired operation of the device.

Le présent appareil est conforme aux CNR d'Industrie Canada applicables aux appareils radio exempts de licence. L'exploitation est autorisée aux deux conditions suivantes : (1) l'appareil ne doit pas produire de brouillage, et (2) l'utilisateur de l'appareil doit accepter tout brouillage radioélectrique subi, même si le brouillage est susceptible d'en compromettre le fonctionnement.

This radio transmitter (identify the device by certification number, or model number if Category II) has been approved by Industry Canada to operate with the antenna types listed below with the maximum permissible gain and required antenna impedance for each antenna type indicated. Antenna types not included in this list, having a gain greater than the maximum gain indicated for that type, are strictly prohibited for use with this device.

Le présent émetteur radio (identifier le dispositif par son numéro de certification ou son numéro de modèle s'il fait partie du matériel de catégorie I) a été approuvé par Industrie Canada pour fonctionner avec les types d'antenne énumérés ci-dessous et ayant un gain admissible maximal et l'impédance requise pour chaque type d'antenne. Les types d'antenne non inclus dans cette liste, ou dont le gain est supérieur au gain maximal indiqué, sont strictement interdits pour l'exploitation de l'émetteur.

3-2. Using the audio system (Entune Audio)

■ Reconnecting the portable audio player

If the portable audio player is disconnected due to poor reception when the engine switch is in the "ACC" or "ON" position (vehicles without a smart key system) or ACCESSORY or IGNITION ON mode (vehicles with a smart key system), the system automatically reconnects the portable audio player.

If you have switched off the portable audio player yourself, follow the instructions below to reconnect:

- Select the portable audio player again
- Enter the portable audio player

■ When you sell your car

Be sure to delete your personal data. (→P. 331)

CAUTION

■ While driving

Do not operate the portable audio player, cellular phone or connect a device to the Bluetooth® system.

■ Caution regarding interference with electronic devices

- Your audio unit is fitted with Bluetooth® antennas. People with implantable cardiac pacemakers, cardiac resynchronization therapy-pacemakers or implantable cardioverter defibrillators should maintain a reasonable distance between themselves and the Bluetooth® antennas. The radio waves may affect the operation of such devices.
- Before using Bluetooth® devices, users of any electrical medical device other than implantable cardiac pacemakers, cardiac resynchronization therapy-pacemakers or implantable cardioverter defibrillators should consult the manufacturer of the device for information about its operation under the influence of radio waves. Radio waves could have unexpected effects on the operation of such medical devices.

3-2. Using the audio system (Entune Audio)

 NOTICE

■ **When leaving the vehicle**

Do not leave your portable audio player or cellular phone in the vehicle. The inside of the vehicle may become hot, causing damage to the portable audio player or cellular phone.

3-2. Using the audio system (Entune Audio) Voice command system

The voice command system enables the hands-free system to be operated using voice commands.

Using the voice command system

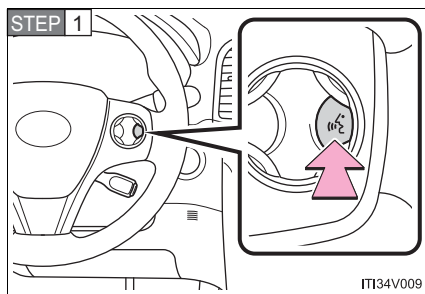

Press the talk switch.

To cancel the voice command system, press and hold the talk switch.

STEP 2 After a beep sounds, say the desired command.

On the list screen, you can select the desired command.

■ **Microphone**

→P. 380

■ **When using the microphone**

- It is unnecessary to speak directly into the microphone when giving a command.
- Voice commands may not be recognized if:
 - They are spoken too quickly.
 - They are spoken at a low or high volume.
 - The roof or windows are open.
 - Passengers are talking while voice commands are spoken.
 - The air conditioning speed is set high.
 - The air conditioning vents are turned towards the microphone.
- In the following conditions, the system may not recognize the command properly and using voice commands may not be possible:
 - The command is incorrect or unclear. Note that certain words, accents or speech patterns may be difficult for the system to recognize.
 - There is excessive background noise, such as wind noise.

Casual speech recognition

Due to natural language speech recognition technology, this system enables recognition of a command when spoken naturally. However, the system cannot recognize every variation of each command.

In some situations, it is possible to omit the command for the procedure and directly state the desired operation.

Not all voice commands are displayed in the shortcut menu.

This function is available in English, Spanish and French.

■ Expression examples for each function

Command	Expression examples
"Call <name> <type>"	Get me <Robert Brown>. Phone <contacts> on his/her <phonetypes> phone.
"Dial <number>"	Get me <3334445555>. Phone <3334445555>.

Command list

Some recognizable voice commands and their actions are shown below as examples.

▶ Basic

Command	Action
"Help"	Prompts voice guidance to offer examples of commands or operation methods
"Go Back"	Returns to the previous screen

▶ Phone

Command	Action
"Redial"	Places a call to the phone number of the latest outgoing call
"Call Back"	Places a call to the phone number of latest incoming call
"Show Recent Calls"	Displays the call history screen
"Dial <phone number>"	Places a call to the said phone number
"Call <contacts> <phonetypes>"	Places a call to the said phone type of the contact from the phone book

3-3. Using the interior lights

Interior lights list

Your Toyota is equipped with the illuminated entry system to assist in entering the vehicle. Due to the function of the system, the lights shown in the following illustration automatically turn on/off according to the presence of the electronic key (vehicles with smart key system), whether the doors are locked/unlocked, whether the doors are opened/closed, and the “ENGINE START STOP” switch mode (vehicles with smart key system) or engine switch position (vehicles without smart key system).

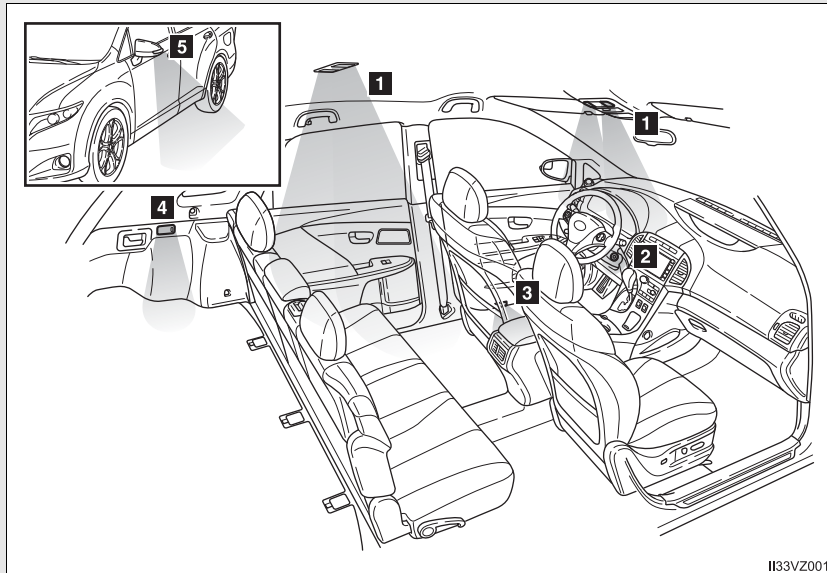

3-3. Using the interior lights

Personal/interior light main switch

- 1** Personal/interior lights
- 2** "ENGINE START STOP" switch light (vehicles with smart key system) or engine switch light (vehicles without smart key system)
- 3** Door courtesy lights
- 4** Luggage compartment light
- 5** Outer foot lights

Personal/interior light main switch

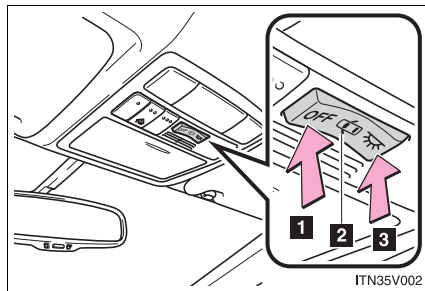

1 "OFF"

The personal/interior lights can be individually turned on or off.

2 Door position

The personal/interior lights come on when a door is opened. They turn off when the doors are closed.

3 On

The personal/interior lights cannot be individually turned off.

3

Interior features

3-3. Using the interior lights

Personal/interior lights and luggage compartment light

Personal/interior lights

► Front

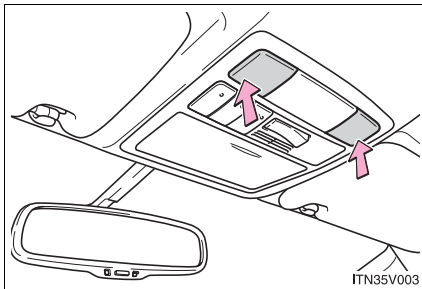

On/off

The illuminated entry system is activated even if the light is turned off when the personal/interior light main switch is in door position.

► Rear

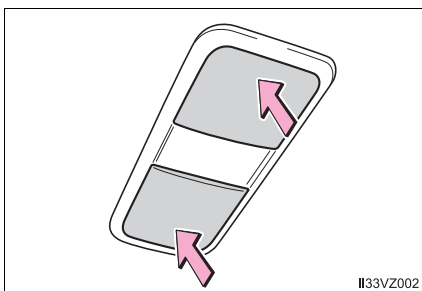

On/off

The illuminated entry system is activated even if the light is turned off when the personal/interior light main switch is in door position.

Luggage compartment light

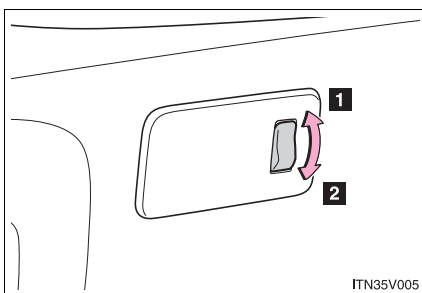

1 Door position

2 Off

■ **To prevent the battery from being discharged**

▶ Vehicles with smart key system

If the personal/interior lights and “ENGINE START STOP” switch light remain on when the door is not fully closed and the personal/interior light main switch is in door position, the lights will go off automatically after 20 minutes.

▶ Vehicles without smart key system

If the personal/interior lights and engine switch light remain on when the door is not fully closed and the personal/interior light main switch is in door position, the lights will go off automatically after 20 minutes.

■ **Customization**

Settings (e.g. The time elapsed before lights turn off) can be changed.
(Customizable features →P. 645)

3-4. Using the storage features
List of storage features

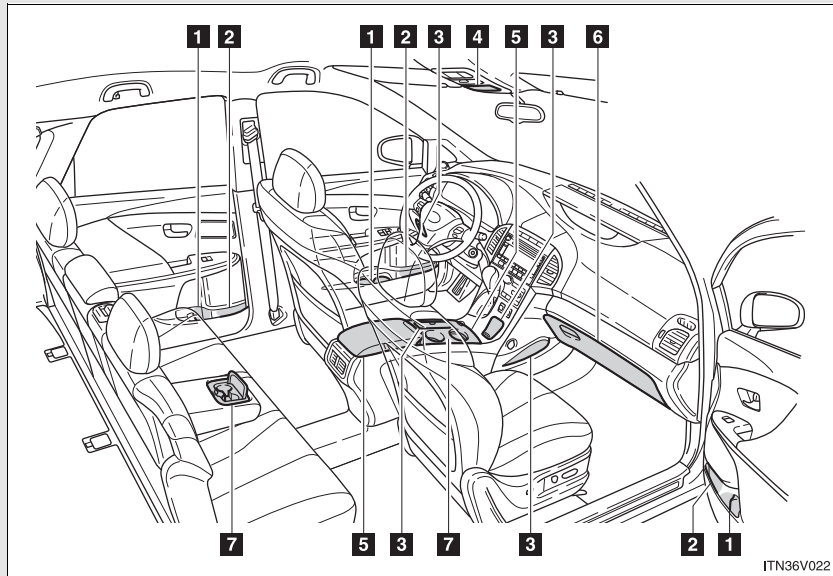

- 1** Bottle holders
- 2** Door pockets
- 3** Auxiliary boxes
- 4** Overhead console
- 5** Console boxes
- 6** Glove box
- 7** Cup holders

⚠ CAUTION**■ Items that should not be left in the storage spaces**

Do not leave glasses, lighters or spray cans in the storage spaces, as this may cause the following when cabin temperature becomes high:

- Glasses may be deformed by heat or cracked if they come into contact with other stored items.
- Lighters or spray cans may explode. If they come into contact with other stored items, the lighter may catch fire or the spray can may release gas, causing a fire hazard.

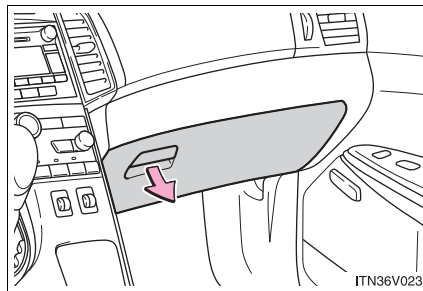
Glove box

Pull up the lever.

3

Interior features

■ Glove box light

The glove box light turns on when the tail lights are on.

⚠ CAUTION**■ While driving**

Keep the glove box closed. In the event of sudden braking or sudden swerving, an accident may occur due to an occupant being struck by the open glove box or the items stored inside.

Console boxes

► Front

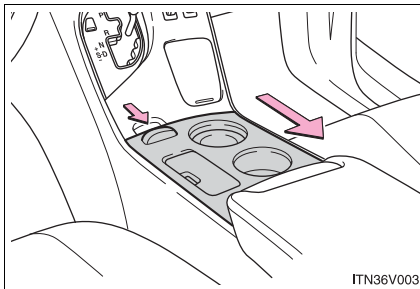

Press the tab and slide to open.

► Rear

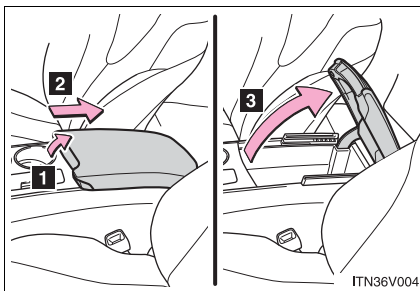

- 1** Pull up the lever to release the lock.
- 2** Slide the armrest fully rearward.
- 3** Lift the armrest to open.

■ **When using the rear console box lid as an armrest**

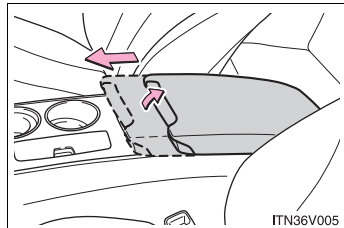

If necessary, the console box lid can slide forward. Pull the lid forward while pulling up the lever.

■ **Tray in the rear console box**

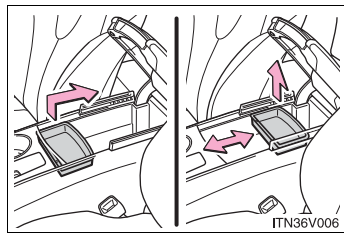

The tray slides forward/backward and can be removed.

⚠ CAUTION

■ **While driving**

Keep the console box closed.
Injuries may result in the event of sudden braking, sudden swerving or an accident.

Overhead console

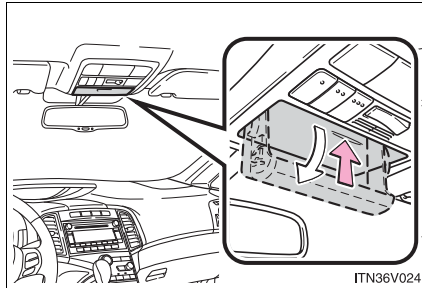

Push the lid.

The overhead console is useful for temporarily storing small items.

⚠ CAUTION

■ While driving

Do not leave the overhead console open. Items may fall out and cause injury.

Cup holders

► Front

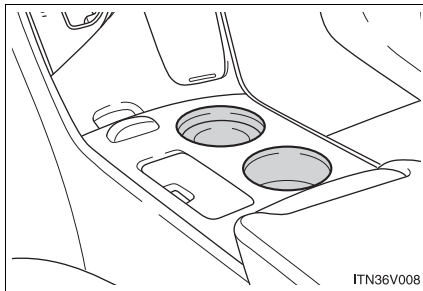

► Rear

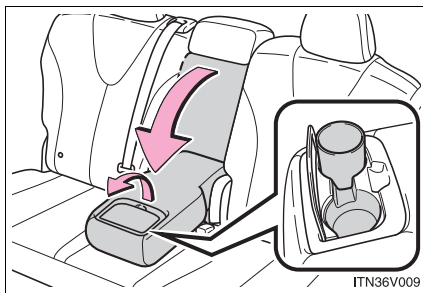

Pull down the armrest and open the lid.

■ **Adjusting size of the front cup holder**

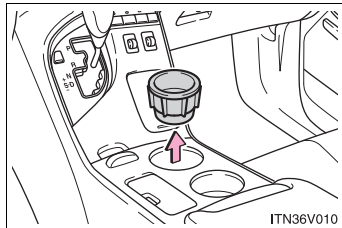

Remove the adapter.

⚠ CAUTION

■ **Items unsuitable for the cup holder**

Do not place anything other than cups or aluminum cans in the cup holders. Other items may be thrown out of the holders in the event of an accident or sudden braking and cause injury. If possible, cover hot drinks to prevent burns.

■ **When not in use**

Keep the rear cup holders closed. Injuries may result in the event of sudden braking, sudden swerving or an accident.

Bottle holders

► For front seats

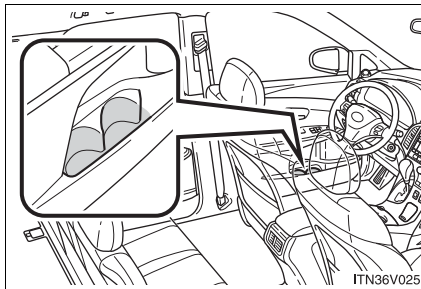

► For rear seats

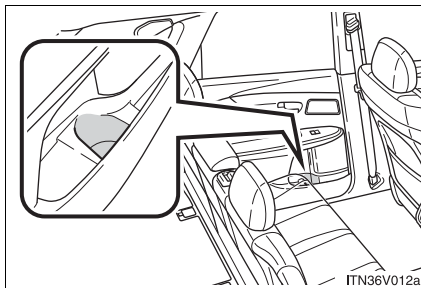

 NOTICE

■ **Items that should not be stowed in the bottle holders**

Put the cap on before stowing a bottle. Do not place open bottles in the bottle holders, or glasses and paper cups containing liquid. The contents may spill and glasses may break.

Auxiliary boxes

▶ Type A (driver's side instrument panel)

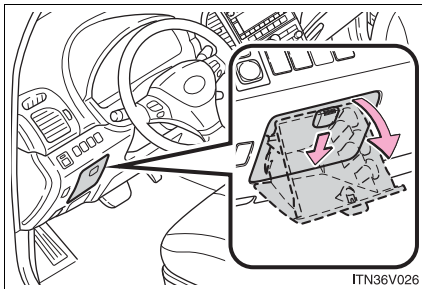

Push down the knob.

▶ Type B (front console)

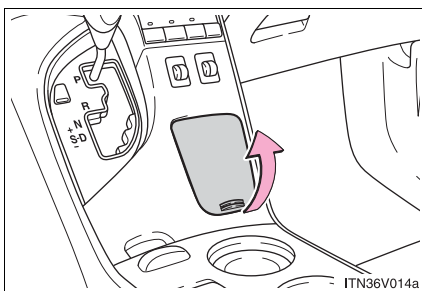

Lift the lid.

▶ Type C (front console)

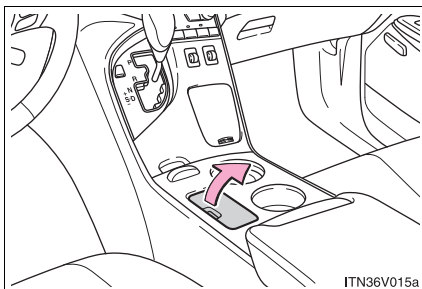

Lift the lid.

3-4. Using the storage features

Auxiliary boxes

► Type D (front passenger's side instrument panel)

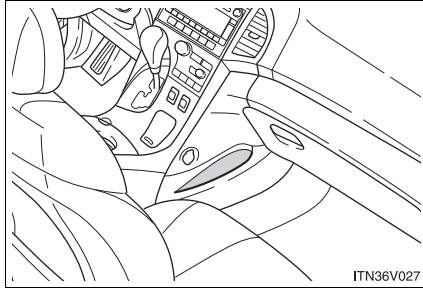

■ Coin holder (type A)

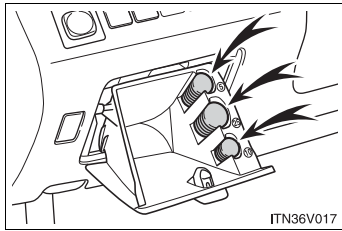

Nickels, quarters and dimes can be stored separately.

3

Interior features

■ Cable pass-through (type B and C)

▶ Type B

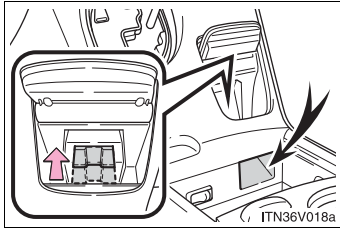

The auxiliary boxes of the front console are provided with a hole that allows cables to be passed from the power outlet and AUX port/USB port.

For type B, push in the push bar before routing the cables. Otherwise the connector end may get stuck.

▶ Type C

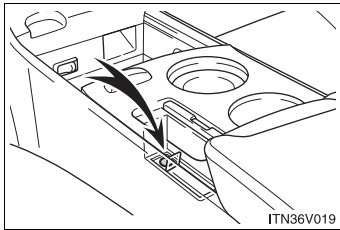

⚠ CAUTION

■ While driving (type A, B and C)

Keep the auxiliary boxes closed.

Injuries may result in the event of sudden braking, sudden swerving or an accident.

3-5. Other interior features

Sun visors

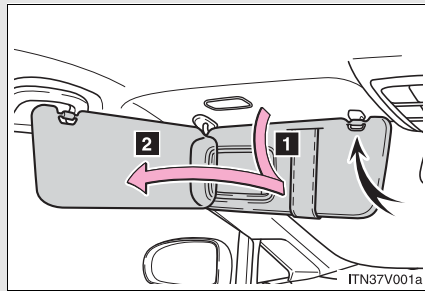

- 1** Forward position:
Flip down.
- 2** Side position:
Flip down, unhook, and swing to the side.

3-5. Other interior features

Vanity mirror

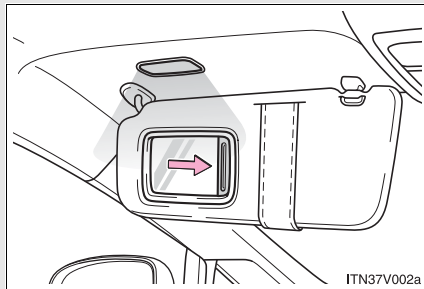

Slide the cover.

The light turns on when the cover is opened.

3-5. Other interior features

Power outlets

The power outlets can be used for 12V accessories that run on less than 10A.

► Console box

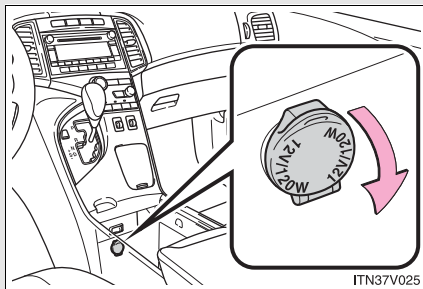

► Front passenger's side instrument panel

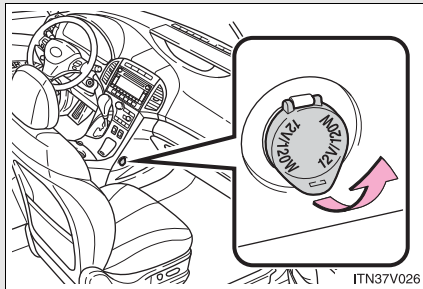

► Luggage compartment

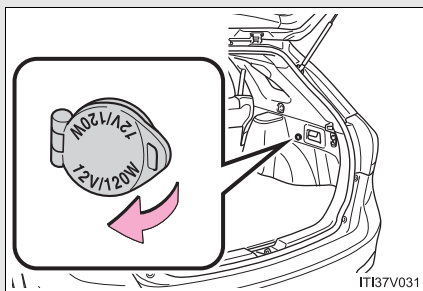

■ **The power outlets can be used when**

- ▶ Vehicles with smart key system

The “ENGINE START STOP” switch is in ACCESSORY or IGNITION ON mode.

- ▶ Vehicles without smart key system

The engine switch is in the “ACC” or “ON” position.

 **NOTICE**

■ **To avoid damaging the power outlets**

Close the power outlet lid when not in use.

Foreign objects or liquids that enter the power outlet may cause a short circuit.

■ **To prevent the fuse from being blown**

Do not use an accessory that uses more than 12 V/10 A.

■ **To prevent the battery from being discharged**

Do not use the power outlet longer than necessary when the engine is not running.

3-5. Other interior features

Seat heaters*

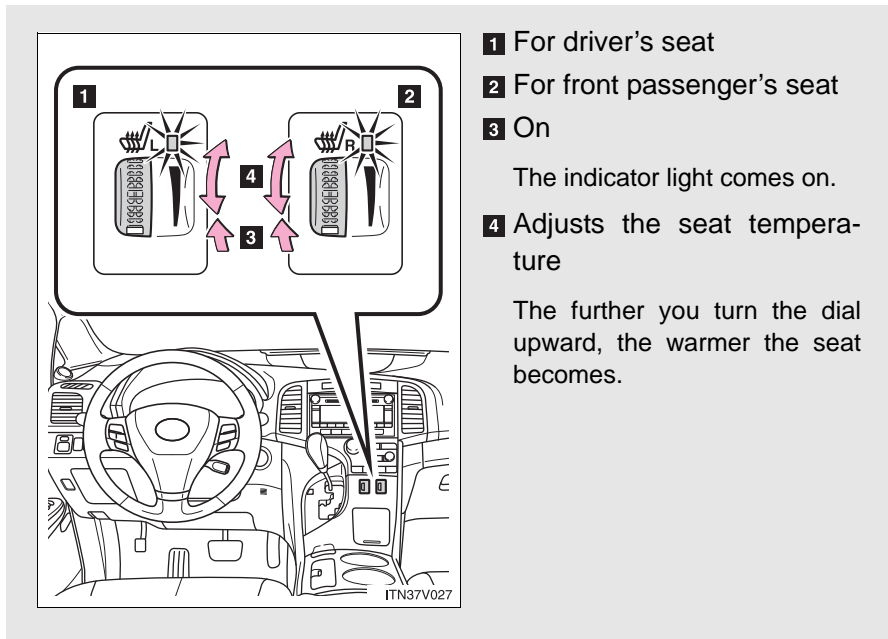

3

Interior features

■ The seat heaters can be used when

- ▶ Vehicles with smart key system
The "ENGINE START STOP" switch is in IGNITION ON mode.
- ▶ Vehicles without smart key system
The engine switch is in the "ON" position.

*: If equipped

449

 CAUTION

■ **Burns**

- Use caution when seating the following persons in a seat with the seat heater on to avoid the possibility of burns:
 - Babies, small children, the elderly, the sick and the disabled
 - Persons with sensitive skin
 - Persons who are fatigued
 - Persons who have taken alcohol or drugs that induce sleep (sleeping drugs, cold remedies, etc.)
- Do not cover the seat with anything when using the seat heater. Using the seat heater with a blanket or cushion increases the temperature of the seat and may lead to overheating.

 NOTICE

■ **To prevent seat heater damage**

Do not put unevenly weighted objects on the seat and do not stick sharp objects (needles, nails, etc.) into the seat.

■ **To prevent battery discharge**

Turn the switches off when the engine is not running.

3-5. Other interior features

Armrest

► Front

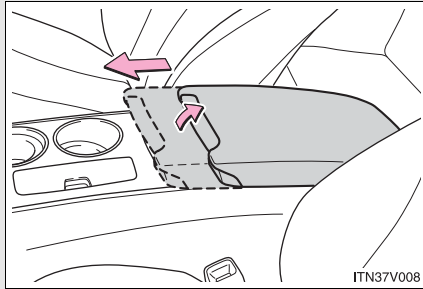

Lift the lever up and slide the armrest.

► Rear

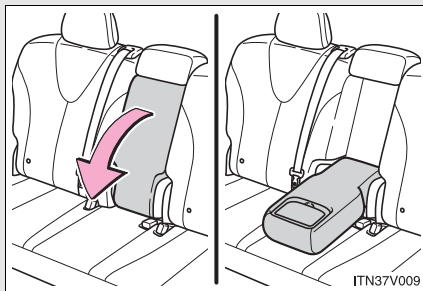

Pull the armrest down for use.

3

Interior features

NOTICE

■ To prevent damage to the armrest

Do not place too much strain on the armrest.

3-5. Other interior features

Assist grips (folding type)

An assist grip installed on the ceiling can be used to support your body while sitting on the seat.

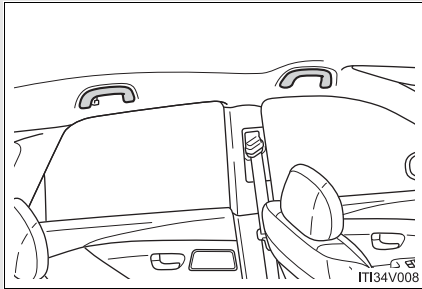

CAUTION

■ Assist grip

Do not use the assist grip when getting in or out of the vehicle or rising from your seat.

NOTICE

■ To prevent damage to the assist grip

Do not hang any heavy object or put a heavy load on the assist grip.

3-5. Other interior features

Floor mats

Use only floor mats designed specifically for vehicles of the same model and model year as your vehicle. Fix them securely in place onto the carpet.

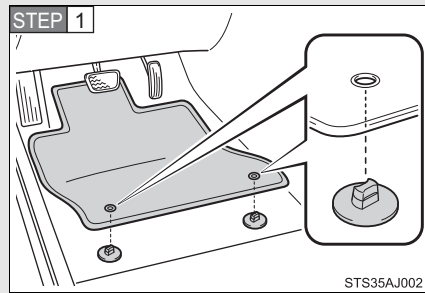

Insert the retaining hooks (clips) into the floor mat eye-lets.

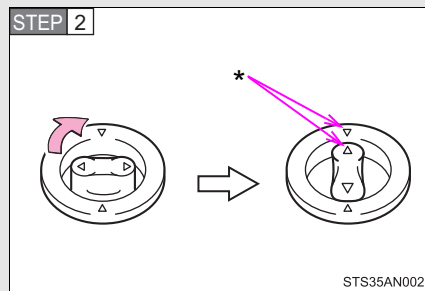

Turn the upper knob of each retaining hook (clip) to secure the floor mats in place.

*: Always align the \triangle marks.

The shape of the retaining hooks (clips) may differ from that shown in the illustration.

3

Interior features

⚠ CAUTION

Observe the following precautions.

Failure to do so may cause the driver's floor mat to slip, possibly interfering with the pedals while driving. An unexpectedly high speed may result or it may become difficult to stop the vehicle, leading to a serious accident.

■ When installing the driver's floor mat

- Do not use floor mats designed for other models or different model year vehicles, even if they are Toyota Genuine floor mats.
- Only use floor mats designed for the driver's seat.
- Always install the floor mat securely using the retaining hooks (clips) provided.
- Do not use two or more floor mats on top of each other.
- Do not place the floor mat bottom-side up or upside-down.

■ Before driving

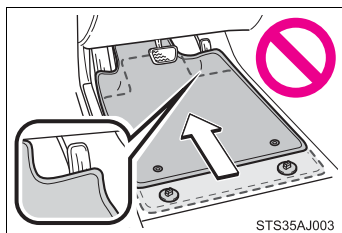

- Check that the floor mat is securely fixed in the correct place with all the provided retaining hooks (clips). Be especially careful to perform this check after cleaning the floor.
- With the engine stopped and the shift lever in P, fully depress each pedal to the floor to make sure it does not interfere with the floor mat.

3-5. Other interior features

Luggage compartment features

■ Cargo hooks

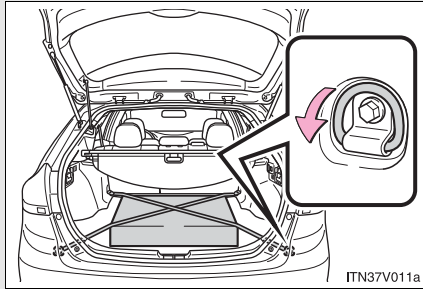

Cargo hooks are provided for securing loose items.

■ Shopping bag hooks

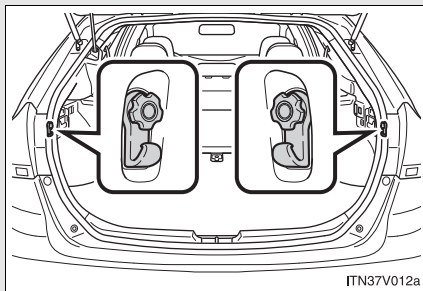

■ Auxiliary box

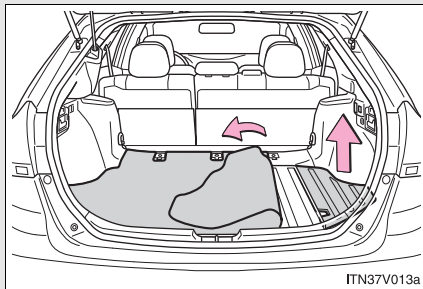

Lift the right side deck board.

3-5. Other interior features

■ Luggage cover

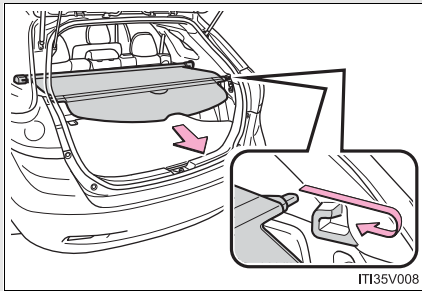

Pull out the luggage cover and hook it on the anchors.

Removing luggage cover

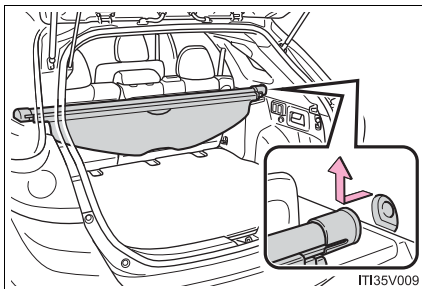

Retract the cover and release both ends, then lift it out.

After removing the luggage cover, place it somewhere other than the passenger compartment.

⚠ CAUTION

■ When the cargo hooks are not in use

To avoid injury, always return the cargo hooks to their positions when they are not in use.

■ While driving

Do not place anything on the luggage cover. Such items may be thrown about and possibly injure people in the vehicle during sudden braking, sudden swerving or an accident.

3-5. Other interior features

Garage door opener

The garage door opener can be programmed to operate garage doors, gates, entry doors, door locks, home lighting systems, security systems, and other devices.

The garage door opener (HomeLink® Universal Transceiver) is manufactured under license from HomeLink®.

Programming HomeLink® (for U.S.A. owners)

To ensure correct programming into the HomeLink®, install a new battery in the hand-held transmitter prior to programming. Failure to install a new battery into the hand-held transmitter will affect both the range and accuracy of the HomeLink® in your vehicle.

The battery side of the hand-held transmitter must be pointed away from the HomeLink® during the programming process.

The HomeLink® compatible transceiver in your vehicle has 3 buttons which can be programmed to operate 3 different devices. Refer to the programming method below appropriate for the device.

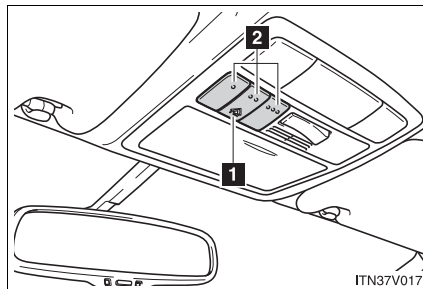

- 1 Indicator
- 2 Buttons

■ Programming HomeLink®

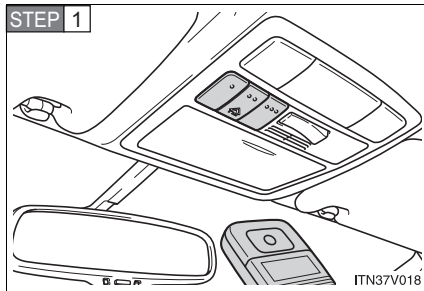

Point the remote control transmitter for the device 1 to 3 in. (25 to 75 mm) from the HomeLink® buttons.

Keep the HomeLink® indicator light in view while programming.

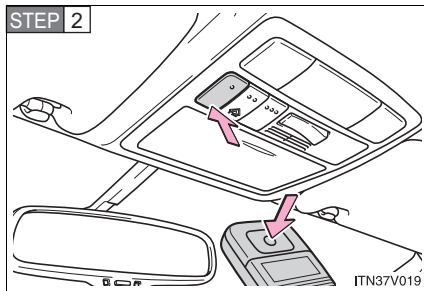

Press and hold one of the HomeLink® buttons and the transmitter button. When the HomeLink® indicator light changes from a slow to a rapid flash within 20 seconds, you can release both buttons.

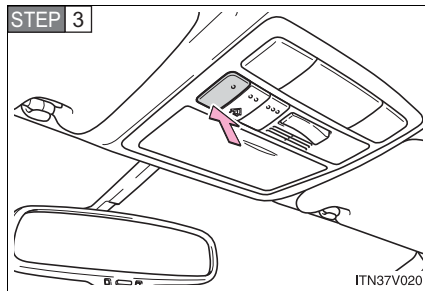

Test the HomeLink[®] operation by pressing the newly programmed button.

If a HomeLink[®] button has been programmed for a garage door, check to see if the garage door opens and closes. If the garage door does not operate, see if your remote control transmitter is of the rolling code type. Press and hold the programmed HomeLink[®] button. The remote control transmitter is of the rolling code type if the HomeLink[®] indicator light flashes rapidly for 2 seconds and then remains lit. If your transmitter is of the rolling code type, proceed to the heading "Programming a rolling code system".

STEP 4 Repeat the steps above to program another device for each of the remaining HomeLink[®] buttons.

■ Programming a rolling code system

If your device is rolling code equipped, follow the steps under the heading “Programming HomeLink[®]” before proceeding with the steps listed below.

STEP 1 Locate the learn button on the ceiling mounted garage door opener motor. The exact location and color of the button may vary by brand of garage door opener motor.

Refer to the operation manual supplied with the garage door opener motor for the location of the learn button.

STEP 2 Press the learn button.

Following this step, you have 30 seconds in which to initiate step 3 below.

STEP 3 Press and hold the vehicle’s programmed HomeLink[®] button for 2 seconds and release it. Repeat this step once again. The garage door may open.

If the garage door opens, the programming process is complete. If the door does not open, press and release the button a third time. This third press and release will complete the programming process by opening the garage door.

The ceiling mounted garage door opener motor should now recognize the HomeLink[®] signal and operate the garage door.

STEP 4 Repeat the steps above to program another rolling code system for any of the remaining HomeLink[®] buttons.

■ Programming an entry gate (for U.S.A. owners)/Programming all devices in the Canadian market

- STEP 1** Place your transmitter 1 to 3 in. (25 to 75 mm) away from the surface of the HomeLink[®].
Keep the HomeLink[®] indicator light in view while programming.
- STEP 2** Press and hold the selected HomeLink[®] button.
- STEP 3** Repeatedly press and release (cycle) the device's remote control button for two seconds each until step 4 is completed.
- STEP 4** When the indicator light on the HomeLink[®] compatible transceiver starts to flash rapidly, release the buttons.
- STEP 5** Test the operation of the HomeLink[®] by pressing the newly programmed button. Check to see if the gate/device operates correctly.
- STEP 6** Repeat the steps above to program another device for each of the remaining HomeLink[®] buttons.

■ Programming other devices

To program other devices such as home security systems, home door locks or lighting, contact your authorized Toyota dealer for assistance.

■ Reprogramming a button

The individual HomeLink[®] buttons cannot be erased but can be reprogrammed. To reprogram a button, follow the "Programming" instructions.

Operating HomeLink®

Press the appropriate HomeLink® button. The HomeLink® indicator light should come on.

The HomeLink® compatible transceiver in your vehicle continues to send a signal for up to 20 seconds as long as the button is pressed.

Erasing the entire HomeLink® memory (all three programs)

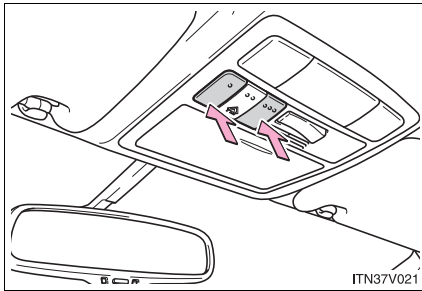

Press and hold the 2 outside buttons for 10 seconds (or 20 seconds depending on the model) until the indicator light flashes.

If you sell your vehicle, be sure to erase the programs stored in the HomeLink® memory.

■ **Before programming**

- Install a new battery in the remote control transmitter.
- The battery side of the remote control transmitter must be pointed away from the HomeLink® button.

■ **Certification for the garage door opener**

FCC ID: CB2300NHL3

FCC ID: CB2281AHL4

NOTE:

This device complies with Part 15 of the FCC Rules.

Operation is subject to the following two conditions: (1) this device may not cause harmful interference, and (2) this device must accept any interference received, including interference that may cause undesired operation.

FCC WARNING:

Changes or modifications not expressly approved by the party responsible for compliance could void the user's authority to operate the equipment.

■ **For additional programming assistance with your HomeLink® Universal Transceiver**

Visit on the web at www.homelink.com or call 1-800-355-3515.

 **CAUTION**

■ **When programming a garage door or other remote control devices**

The garage door or other devices may operate, so ensure people and objects are out of danger to prevent potential harm.

■ **Conforming to federal safety standards**

Do not use the HomeLink® compatible transceiver with any garage door opener or device that lacks safety stop and reverse features as required by federal safety standards.

This includes any garage door that cannot detect an interfering object. A door or device without these features increases the risk of death or serious injury.

3-5. Other interior features

Compass

The compass on the inside rear view mirror indicates the direction in which the vehicle is heading.

■ Operation

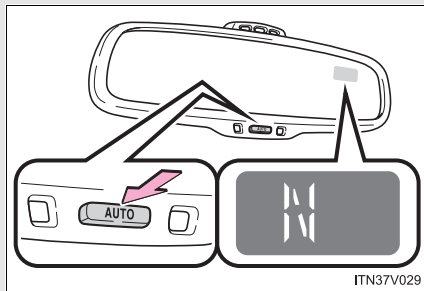

To turn the compass on or off, push and hold "AUTO" for longer than 3 seconds.

■ Displays and directions

Display	Direction
N	North
NE	Northeast
E	East
SE	Southeast
S	South
SW	Southwest
W	West
NW	Northwest

Calibrating the compass

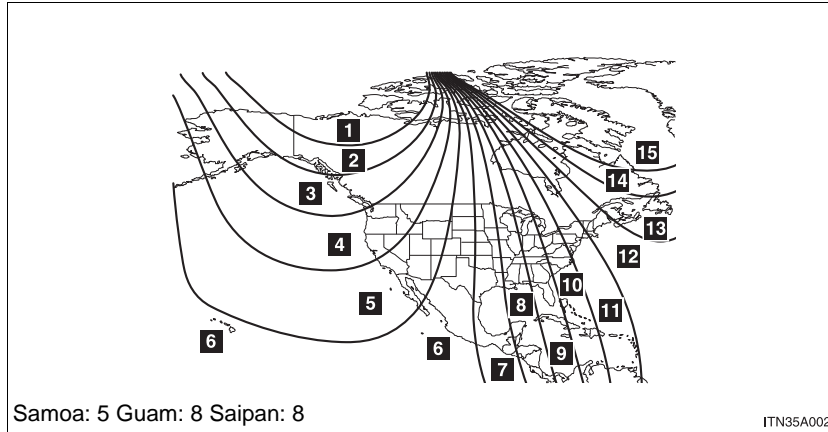

The direction display deviates from the true direction determined by the earth's magnetic field. The amount of deviation varies according to the geographic position of the vehicle.

If you cross over a map boundary shown in illustration, the compass will deviate.

To obtain higher precision or perfect calibration, refer to the following.

■ Deviation calibration

STEP 1 Stop the vehicle where it is safe to drive in a circle.

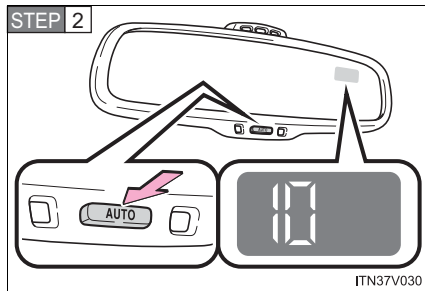

Push and hold "AUTO" until a number (1 to 15) appears on the compass display.

STEP 3 Press "AUTO", and referring to the map above, select the number of the zone where you are.

STEP 4 Wait a few seconds until the compass direction is displayed.
The calibration is complete.

■ Circling calibration

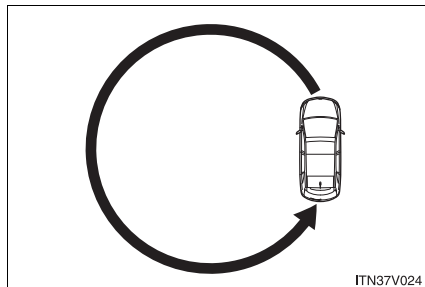

If "C" appears on the display, drive the vehicle at 5 mph (8 km/h) or less in a circle until a direction is displayed.

If there is not enough space to drive in a circle, drive around the block until the direction is displayed.

■ **Conditions unfavorable to correct operation**

The compass may not show the correct direction in the following conditions:

- The vehicle is stopped immediately after turning.
- The vehicle is on an inclined surface.
- The vehicle is in a place where the earth's magnetic field is subject to interference by artificial magnetic fields (underground car park/parking lot, under a steel tower, between buildings, roof car park/parking lot, near an intersection, near a large vehicle, etc.).
- The vehicle has become magnetized.
(There is a magnet or metal object near the inside rear view mirror.)
- The battery has been disconnected.

 **CAUTION**

■ **While driving**

Do not adjust the display.
Be sure to adjust the display only when the vehicle is stopped.

■ **When doing the circling calibration**

Be sure to secure a wide space, and watch out for people and vehicles in the neighborhood. Do not violate any local traffic rules while performing circling calibration.

3-5. Other interior features

 NOTICE

■ **To avoid the compass malfunctions**

Do not place magnets or any metal objects near the inside rear view mirror. Doing this may cause a malfunction of the compass sensor.

■ **To ensure normal operation of the compass**

- Do not perform circling calibration of the compass in a place where the earth's magnetic field is subject to interference by artificial magnetic fields.
- During calibration, do not operate electric systems (moon roof, power windows, etc.) as they may interfere with the calibration.

- 4-1. Maintenance and care**
 - Cleaning and protecting the vehicle exterior..... 470
 - Cleaning and protecting the vehicle interior..... 473

- 4-2. Maintenance**
 - Maintenance requirements..... 476
 - General maintenance..... 479
 - Emission inspection and maintenance (I/M) programs..... 482

- 4-3. Do-it-yourself maintenance**
 - Do-it-yourself service precautions 483
 - Hood 487
 - Positioning a floor jack 489
 - Engine compartment..... 491
 - Tires 506
 - Tire inflation pressure 513
 - Wheels 517
 - Air conditioning filter..... 520
 - Key battery..... 523
 - Checking and replacing fuses..... 527
 - Light bulbs..... 537

4-1. Maintenance and care

Cleaning and protecting the vehicle exterior

Perform the following to protect the vehicle and maintain it in prime condition.

- Working from top to bottom, liberally apply water to the vehicle body, wheel wells and underside of the vehicle to remove any dirt and dust.

Wash the vehicle body using a sponge or soft cloth, such as a chamois.

- For hard-to-remove marks, use car wash soap and rinse thoroughly with water.
- Wipe away any water.
- Wax the vehicle when the waterproof coating deteriorates.

If water does not bead on a clean surface, apply wax when the vehicle body is cool.

■ Automatic car washes

- Before washing the vehicle, do the following.
 - Fold the mirrors back.
 - Turn the power back door system off.
- Brushes used in automatic car washes may scratch the vehicle surface and harm your vehicle's paint.

■ **High pressure car washes**

- Do not allow the nozzles of the car wash to come within close proximity of the windows.
- Before car wash, check that the fuel filler door is closed.

■ **Aluminum wheels**

- Remove any dirt immediately by using a neutral detergent. Do not use hard brushes or abrasive cleaners. Do not use strong or harsh chemical cleaners. Use the same mild detergent and wax as used on the paint.
- Do not use detergent on the wheels when they are hot, for example after driving for long distance in the hot weather.
- Wash detergent from the wheels immediately after use.

■ **Bumpers and side moldings**

Do not scrub with abrasive cleaners.

 **CAUTION**

■ **Caution about the exhaust pipe**

Exhaust gasses cause the exhaust pipe to become quite hot. When washing the vehicle, be careful not to touch the pipe until it has cooled sufficiently, as touching a hot exhaust pipe can cause burns.

 NOTICE

■ **To prevent paint deterioration and corrosion on the body and components (aluminum wheels etc.)**

- Wash the vehicle immediately in the following cases:
 - After driving near the sea coast
 - After driving on salted roads
 - If you see coal tar or tree sap on the paint surface
 - If you see dead insects, insect droppings or bird droppings on the paint
 - After driving in an area contaminated with soot, oily smoke, mine dust, iron powder or chemical substances
 - If the vehicle becomes heavily soiled in dust or mud
 - If liquids such as benzine and gasoline are spilled on the paint surface
- If the paint is chipped or scratched, have it repaired immediately.
- To prevent the wheels from corroding, remove any dirt and store in a place with low humidity when storing the wheels.

■ **If the windshield washer nozzle become blocked**

Contact your Toyota dealer. Do not try to clear it with a pin or other object. This may damage the nozzle.

■ **Cleaning the exterior lights**

- Wash carefully. Do not use organic substances or scrub with a hard brush. This may damage the surfaces of the lights.
- Do not apply wax on the surface of the lights. Wax may cause damage to the lenses.

■ **To prevent damage to the windshield wiper arms**

When lifting the wiper arms away from the windshield, pull the driver side wiper arm upward first, and repeat for the passenger side. When returning the wipers to their original position, do so from the passenger side first.

Cleaning and protecting the vehicle interior

The following procedures will help protect your vehicle's interior and keep it in top condition:

■ **Protecting the vehicle interior**

Remove dirt and dust using a vacuum cleaner. Wipe dirty surfaces with a cloth dampened with lukewarm water.

■ **Cleaning the leather areas**

- Remove dirt and dust using a vacuum cleaner.
- Wipe any excess dirt and dust with a soft cloth dampened with diluted detergent.

Use a diluted water solution of approximately 5% neutral wool detergent.

- Wring out any excess water from the cloth and thoroughly wipe off all remaining traces of detergent.
- Wipe the surface with a dry, soft cloth to remove any remaining moisture. Allow the leather to dry in shaded and ventilated area.

■ **Synthetic leather areas**

- Remove loose dirt using a vacuum cleaner.
- Apply a mild soap solution to the synthetic leather using a sponge or soft cloth.
- Allow the solution to soak in for a few minutes. Remove the dirt and wipe off the solution with a clean, damp cloth.

■ **Caring for leather areas**

Toyota recommends cleaning the interior of the vehicle at least twice a year to maintain the quality of the vehicle's interior.

■ **Shampooing the carpets**

There are several commercial foaming-type cleaners available. Use a sponge or brush to apply the foam. Rub in overlapping circles. Do not apply water. Excellent results are obtained by keeping the carpet as dry as possible.

■ **Seat belts**

Clean with mild soap and lukewarm water using a cloth or sponge. Also check the belts periodically for excessive wear, fraying or cuts.

 **CAUTION**

■ **Water in the vehicle**

- Do not splash or spill liquid in the vehicle.
Doing so may cause electrical components etc. to malfunction or catch fire.
- Do not get any of the SRS components or wiring in the vehicle interior wet.
(→P. 121)
Electrical malfunction may cause the airbags to deploy or not function properly, resulting in death or serious injury.

■ **Cleaning the interior (especially instrument panel)**

Do not use polish wax or polish cleaner. The instrument panel may reflect off the windshield, obstructing the driver's view and leading to an accident, resulting in death or serious injury.

 NOTICE

■ **Cleaning detergents**

- Do not use the following types of detergent, as they may discolor the vehicle interior or cause streaks or damage to painted surfaces.
 - Non-seat portions: Organic substances such as benzene or gasoline, alkaline or acidic solutions, dye, or bleach.
 - Seats: Acidic solutions, such as thinner, benzene, or alcohol.
- Do not use polish wax or polish cleaner. The instrument panel's or other interior part's painted surface may be damaged.

■ **Preventing damage to leather surfaces**

Observe the following precautions to avoid damage to and deterioration of leather surfaces.

- Remove any dust or dirt on leather surfaces immediately.
- Do not expose the vehicle to direct sunlight for extended periods of time. Park the vehicle in the shade, especially during summer.
- Do not place items made of vinyl, plastic, or that contain wax on the upholstery, as they may stick to the leather surface if the vehicle interior heats up significantly.

■ **Water on the floor**

Do not wash the vehicle floor with water.

Vehicle systems such as the audio system may be damaged if water comes into contact with electrical components under the floor of the vehicle, and may also cause the body to rust.

■ **Cleaning the inside of the rear window**

- Be careful not to scratch or damage the heater wires or antenna.
- Do not use glass cleaner to clean the rear window, as this may cause damage to the rear window defogger heater wires or antenna. Use a cloth dampened with lukewarm water to gently wipe the window clean. Wipe the window in strokes running parallel to the heater wires or antenna.

Maintenance requirements

To ensure safe and economical driving, day-to-day care and regular maintenance is essential. It is the owner's responsibility to perform regular checks. Toyota recommends the following maintenance.

■ **General maintenance**

Should be performed on a daily basis. This can be done by yourself or by a Toyota dealer.

■ **Scheduled maintenance**

Should be performed at specified intervals according to the maintenance schedule.

For details about maintenance items and schedules, refer to the "Scheduled Maintenance Guide", "Owner's Manual Supplement".

■ **Do-it-yourself maintenance**

You can perform some maintenance procedures yourself. Please be aware that do-it-yourself maintenance may affect warranty coverage.

The use of Toyota Repair Manuals is recommended.

For details about warranty coverage, see the separate "Owner's Warranty Information Booklet", "Owner's Manual Supplement".

■ **Repair and replacement**

It is recommended that genuine Toyota parts be used for repair to ensure performance of each system. If non-Toyota parts are used in replacement or if a repair shop other than a Toyota dealer performs repairs, confirm the warranty coverage.

■ Resetting the maintenance reminder light (U.S.A. only)

After the required maintenance is performed according to the maintenance schedule, please reset the reminder light.

To reset the data, follow the procedures described below:

STEP 1 Switch the display to the trip meter A when the engine is running.
(→P. 189)

STEP 2 Vehicles with smart key system:
Turn the “ENGINE START STOP” switch off.

Vehicles without smart key system:
Turn the engine switch to the “LOCK” position.

STEP 3 Vehicles with smart key system:
While pressing the trip meter reset button, set the “ENGINE START STOP” switch to IGNITION ON mode (but do not start the engine because otherwise the reset mode will be canceled). Continue to press and hold the trip meter reset button until the trip meter displays “000000”.

Vehicles without smart key system:
While pressing the trip meter reset button, set the engine switch to “ON” position (but do not start the engine because otherwise the reset mode will be canceled). Continue to press and hold the trip meter reset button until the trip meter displays “000000”.

■ Allow inspection and repairs to be performed by a Toyota dealer

- Toyota technicians are well-trained specialists and are kept up to date with the latest service information. They are well informed about the operations of all systems on your vehicle.
- Keep a copy of the repair order. It proves that the maintenance that has been performed is under warranty coverage. If any problem should arise while your vehicle is under warranty, your Toyota dealer will promptly take care of it.

 CAUTION

■ **Warning in handling of battery, oils, fuels, and fluids**

- Engine exhaust, some of its constituents, and a wide variety of automobile components contain or emit chemicals known to the State of California to cause cancer and birth defects and other reproductive harm. Work in a well ventilated area.
- Oils, fuels and fluids contained in vehicles as well as waste produced by component wear contain or emit chemicals known to the State of California to cause cancer and birth defects or other reproductive harm. Avoid exposure and wash any affected area immediately.
- Battery posts, terminals and related accessories contain lead and lead compounds which are known to cause brain damage. Wash your hands after handling. (→P. 502)

4-2. Maintenance

General maintenance

Listed below are the general maintenance items that should be performed at the intervals specified in the “Scheduled Maintenance Guide”, “Owner’s Manual Supplement”. It is recommended that any problem you notice should be brought to the attention of your Toyota dealer or qualified service shop for advice.

Engine compartment

Items	Check points
Battery	• Maintenance-free (→P. 502)
Brake fluid	• At the correct level? (→P. 500)
Engine coolant	• At the correct level? (→P. 497)
Engine oil	• At the correct level? (→P. 493)
Exhaust system	• No fumes or strange sounds?
Radiator/condenser/hoses	• Not blocked with foreign matter? (→P. 499)
Washer fluid	• At the correct level? (→P. 505)

Vehicle interior

Items	Check points
Accelerator pedal	<ul style="list-style-type: none"> • Moves smoothly (without uneven pedal effort or catching)?
Automatic transmission "Park" mechanism	<ul style="list-style-type: none"> • Can the vehicle be held securely on an incline with the shift lever in "P"?
Brake pedal	<ul style="list-style-type: none"> • Moves smoothly? • Does it have appropriate clearance and correct amount of free play?
Brakes	<ul style="list-style-type: none"> • Pulls to one side when applied? • Loss of brake effectiveness? • Spongy feeling brake pedal? • Pedal almost touches floor?
Head restraints	<ul style="list-style-type: none"> • Move smoothly and lock securely?
Indicators/buzzers	<ul style="list-style-type: none"> • Function properly?
Lights	<ul style="list-style-type: none"> • Do all the lights come on? • Headlights aimed correctly?
Parking brake	<ul style="list-style-type: none"> • Moves smoothly? • Can hold the vehicle securely on an incline?
Seat belts	<ul style="list-style-type: none"> • Does the seat belt system operate smoothly? • Are the belts undamaged?
Seats	<ul style="list-style-type: none"> • Do the seat controls operate properly?
Steering wheel	<ul style="list-style-type: none"> • Moves smoothly? • Has correct free play? • No strange noises?

Vehicle exterior

Items	Check points
Doors	<ul style="list-style-type: none"> • Operate smoothly?
Engine hood	<ul style="list-style-type: none"> • The lock system works properly?
Fluid leaks	<ul style="list-style-type: none"> • Is there any leakage after parking?
Tire	<ul style="list-style-type: none"> • Is the tire inflation pressure correct? • The tires should not be damaged or excessively worn. • Have the tires been rotated according to the maintenance schedule? • The wheel nuts should not be loose.
Windshield wipers/rear window wiper	<ul style="list-style-type: none"> • The wiper blades should not show any signs of cracking, splitting, wear, contamination or deformation. • The wiper blades should clear the windshield/rear window without streaking or skipping.

⚠ CAUTION**■ If the engine is running**

Turn off the engine and ensure that there is adequate ventilation before performing maintenance checks.

Some states have vehicle emission inspection programs which include OBD (On Board Diagnostics) checks. The OBD system monitors the operation of the emission control system.

■ **If the malfunction indicator lamp comes on**

The OBD system determines that a problem exists somewhere in the emission control system. Your vehicle may not pass the I/M test and may need to be repaired. Contact your Toyota dealer to service the vehicle.

■ **Your vehicle may not pass the I/M test:**

- When the battery is disconnected or discharged

Readiness codes that are set during ordinary driving are erased.

Also, depending on your driving habits, the readiness codes may not be completely set.

- When the fuel tank cap is loose

The malfunction indicator lamp comes on as a temporary malfunction and your vehicle may not pass the I/M test.

■ **When the malfunction indicator lamp goes off after several driving trips**

The error code in the OBD system will not be cleared unless the vehicle is driven 40 or more times.

■ **If your vehicle does not pass the I/M test**

Contact your Toyota dealer to prepare the vehicle for re-testing.

4-3. Do-it-yourself maintenance

Do-it-yourself service precautions

If you perform maintenance yourself, be sure to follow the correct procedure given in these sections.

Items	Parts and tools
Battery condition (→P. 502)	<ul style="list-style-type: none"> • Warm water • Baking soda • Grease • Conventional wrench (for terminal clamp bolts)
Brake fluid level (→P. 500)	<ul style="list-style-type: none"> • FMVSS No.116 DOT 3 or SAE J1703 brake fluid • Rag or paper towel • Funnel (used only for adding brake fluid)
Engine coolant level (→P. 497)	<ul style="list-style-type: none"> • “Toyota Super Long Life Coolant” or similar high quality ethylene glycol based non-silicate, non-amine, non-nitrite and non-borate coolant with long-life hybrid organic acid technology. For the U.S.A.: “Toyota Super Long Life Coolant” is pre-mixed with 50% coolant and 50% deionized water. For Canada: “Toyota Super Long Life Coolant” is pre-mixed with 55% coolant and 45% deionized water. • Funnel (used only for adding coolant)

4-3. Do-it-yourself maintenance

Items	Parts and tools
Engine oil level (→P. 493)	<ul style="list-style-type: none"> • “Toyota Genuine Motor Oil” or equivalent • Rag or paper towel • Funnel (used only for adding engine oil)
Fuses (→P. 527)	<ul style="list-style-type: none"> • Fuse with same amperage rating as original
Radiator and condenser (→P. 499)	—
Tire inflation pressure (→P. 513)	<ul style="list-style-type: none"> • Tire pressure gauge • Compressed air source
Washer fluid (→P. 505)	<ul style="list-style-type: none"> • Water • Washer fluid containing antifreeze (for winter use) • Funnel (used only for adding washer fluid)

 CAUTION

The engine compartment contains many mechanisms and fluids that may move suddenly, become hot, or become electrically energized. To avoid death or serious injury observe the following precautions.

■ **When working on the engine compartment**

- Keep hands, clothing, and tools away from the moving fan and engine drive belt.
- Be careful not to touch the engine, inverter, radiator, exhaust manifold, etc. right after driving as they may be hot. Oil and other fluids may also be hot.
- Do not leave anything that may burn easily, such as paper or rags, in the engine compartment.
- Do not smoke, cause sparks or expose an open flame to fuel or the battery. Fuel and battery fumes are flammable.
- Be extremely cautious when working on the battery. It contains poisonous and corrosive sulfuric acid.

 CAUTION

■ **When working near the electric cooling fan or radiator grille**

▶ Vehicles with smart key system

Be sure the “ENGINE START STOP” switch is off. With the “ENGINE START STOP” switch in IGNITION ON mode, the electric cooling fan may automatically start to run if the air conditioning is on and/or if the coolant temperature is high. (→P. 499)

▶ Vehicles without smart key system

Be sure the engine switch is in the “LOCK” position. With the engine switch in the “ON” position, the electric cooling fan may automatically start to run if the air conditioning is on and/or if the coolant temperature is high. (→P. 499)

■ **When working on or under the vehicle**

Do not get under the vehicle with just the jack supporting it.
Always use automotive jack stands or other solid supports.

■ **Safety glasses**

Wear safety glasses to prevent flying or falling material, fluid spray, etc. from getting in your eyes.

 NOTICE

■ **If you remove the air cleaner filter**

Driving with the air cleaner filter removed may cause excessive engine wear due to dirt in the air. Also a backfire could cause a fire in the engine compartment.

4-3. Do-it-yourself maintenance Hood

Release the lock from the inside of the vehicle to open the hood.

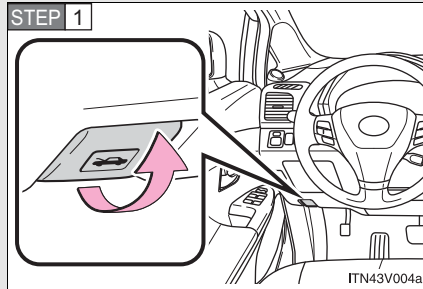

Pull the hood release lever.
The hood will pop up slightly.

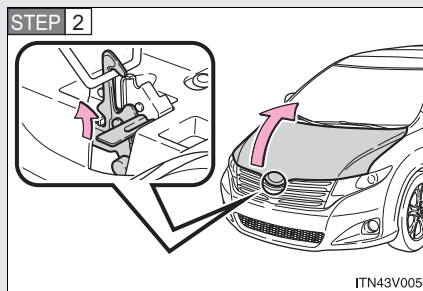

Lift the hood catch and lift the hood.

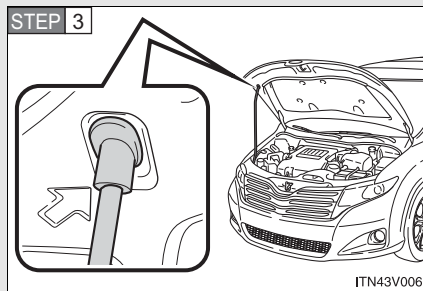

Hold the hood open by inserting the supporting rod into the slot.

4-3. Do-it-yourself maintenance

CAUTION

■ **Pre-driving check**

Check that the hood is fully closed and locked.
If the hood is not locked properly it may open while the vehicle is in motion and cause an accident, which may result in death or serious injury.

■ **After installing the support rod into the slot**

Make sure the rod supports the hood securely from falling down on to your head or body.

NOTICE

■ **When closing the hood**

Be sure to return the support rod to its clip before closing the hood. Closing the hood with the support rod up could cause the hood to bend.

4-3. Do-it-yourself maintenance Positioning a floor jack

When raising your vehicle with a floor jack, position the jack correctly. Improper placement may damage your vehicle or cause injury.

► Front

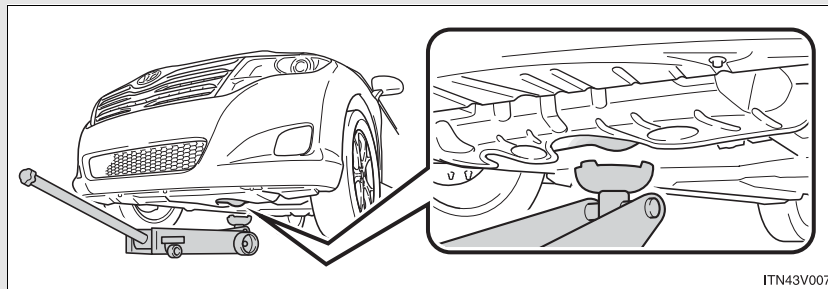

► Rear (2WD models)

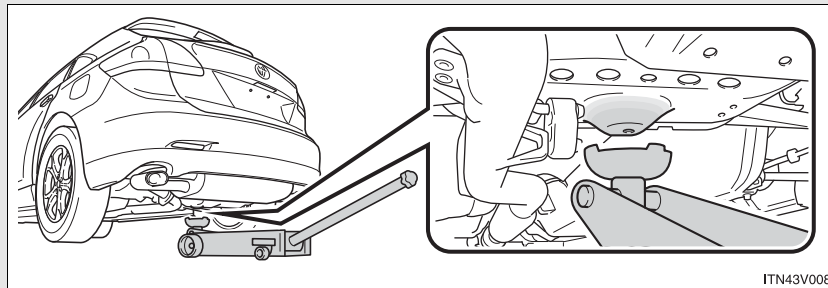

► Rear (AWD models)

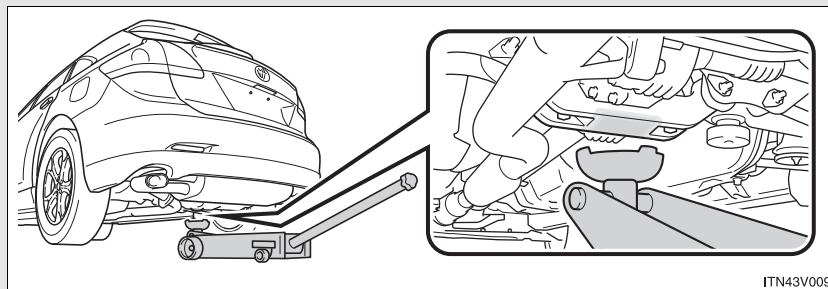

! CAUTION

■ When raising your vehicle

Make sure to observe the following to reduce the possibility of death or serious injury.

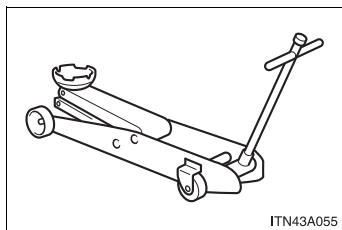

● Lift up the vehicle using a floor jack such as the one shown in the illustration.

- When using a floor jack, follow the instructions of the manual provided with the jack.
- Do not use the jack that was supplied with your vehicle.
- Do not put any part of your body or get underneath the vehicle supported only by the floor jack.
- Always use floor jack and/or automotive jack stands on a solid, flat, level surface.
- Do not start the engine while the vehicle is supported by the floor jack.
- Stop the vehicle on level firm ground, firmly set the parking brake and put the shift lever in "P".
- Make sure to set the floor jack properly at the jack point.
Raising the vehicle with an improperly positioned floor jack will damage the vehicle and may cause the vehicle to fall off the floor jack.
- Do not raise the vehicle while someone is in the vehicle.
- When raising the vehicle, do not place any objects on top of or underneath the floor jack.

4-3. Do-it-yourself maintenance Engine compartment

▶ 2GR-FE engine

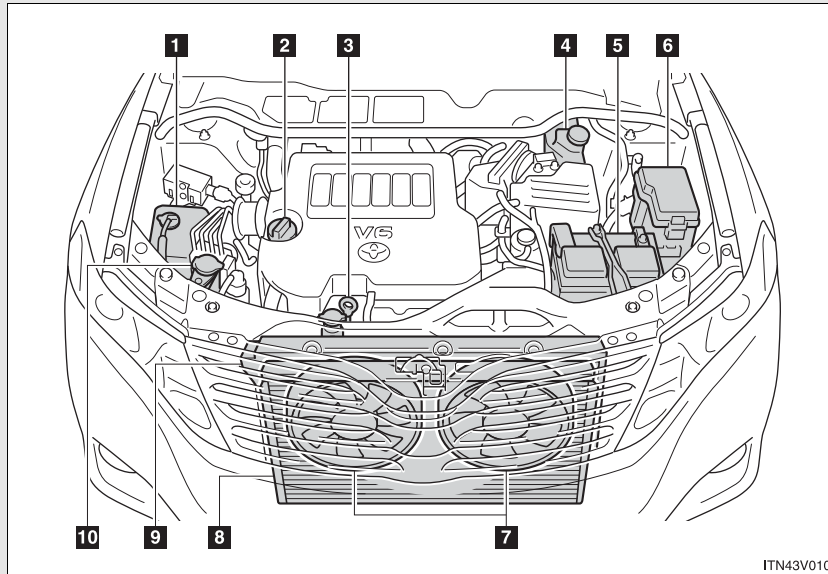

- | | |
|---|--|
| 1 Engine coolant reservoir
(→P. 497) | 5 Battery
(→P. 502) |
| 2 Engine oil filler cap
(→P. 495) | 6 Fuse box
(→P. 527) |
| 3 Engine oil level dipstick
(→P. 493) | 7 Electric cooling fans |
| 4 Brake fluid reservoir
(→P. 500) | 8 Condenser
(→P. 499) |
| | 9 Radiator
(→P. 499) |
| | 10 Washer fluid tank
(→P. 505) |

4-3. Do-it-yourself maintenance

► 1AR-FE engine

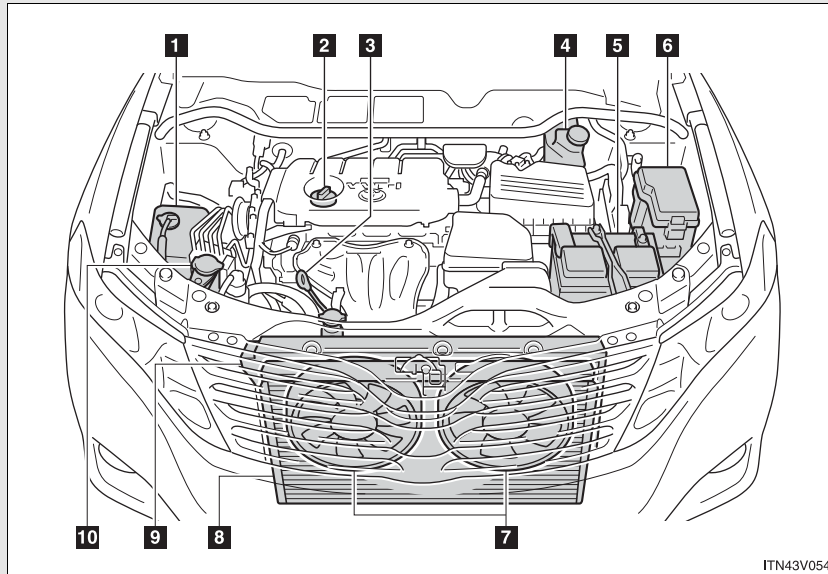

ITN43V054

- | | |
|---|--|
| 1 Engine coolant reservoir
(→P. 497) | 5 Battery
(→P. 502) |
| 2 Engine oil filler cap
(→P. 495) | 6 Fuse box
(→P. 527) |
| 3 Engine oil level dipstick
(→P. 493) | 7 Electric cooling fans |
| 4 Brake fluid reservoir
(→P. 500) | 8 Condenser
(→P. 499) |
| | 9 Radiator
(→P. 499) |
| | 10 Washer fluid tank
(→P. 505) |

Engine oil

With the engine at operating temperature and turned off, check the oil level on the dipstick.

■ Checking the engine oil

STEP 1 Park the vehicle on level ground. After warming up the engine and turning it off, wait more than five minutes for the oil to drain back into the bottom of the engine.

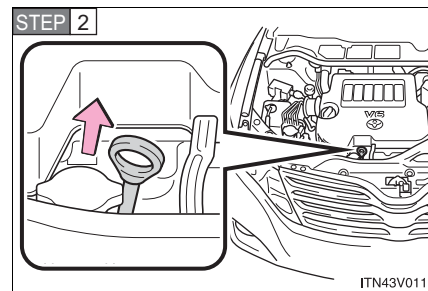

Hold a rag under the end and pull the dipstick out.

STEP 3 Wipe the dipstick clean.

STEP 4 Reinsert the dipstick fully.

4-3. Do-it-yourself maintenance

STEP 5 Holding a rag under the end, pull the dipstick out and check the oil level.

► Flat dipstick

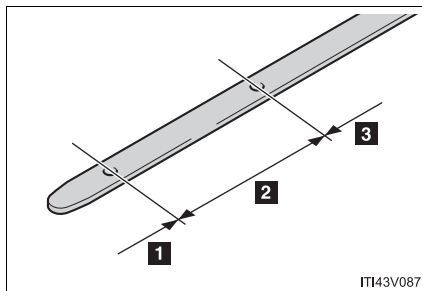

- 1** Low
- 2** Normal
- 3** Excessive

The shape of the dipstick may differ depending on the type of vehicle or engine.

► Non-flat dipstick

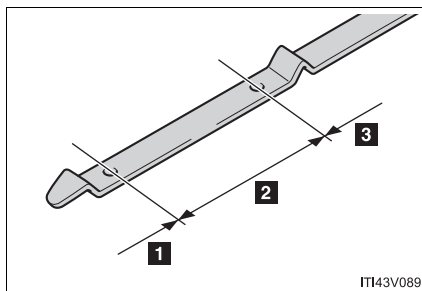

- 1** Low
- 2** Normal
- 3** Excessive

The shape of the dipstick may differ depending on the type of vehicle or engine.

STEP 6 Wipe the dipstick and reinsert it fully.

■ Adding engine oil

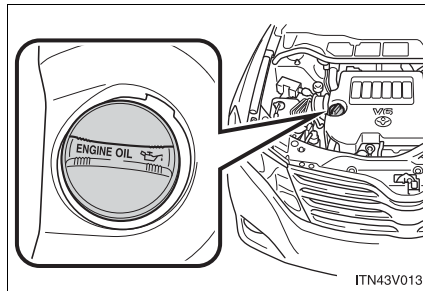

If the oil level is below or near the low level mark, add engine oil of the same type as already in the engine.

Make sure to check the oil type and prepare the items needed before adding oil.

Engine oil selection	→P. 616
Oil quantity (Low → Full)	1.6 qt. (1.5 L, 1.3 Imp. qt.)
Items	Clean funnel

- STEP 1** Remove the oil filler cap.
- STEP 2** Add engine oil slowly, checking the dipstick.
- STEP 3** Install the filler cap, turning it clockwise.

■ Engine oil consumption

A certain amount of engine oil will be consumed while driving. In the following situations, oil consumption may increase, and engine oil may need to be refilled in between oil maintenance intervals.

- When the engine is new, for example directly after purchasing the vehicle or after replacing the engine
- If low quality oil or oil of an inappropriate viscosity is used
- When driving at high engine speeds or with a heavy load, when towing, or when driving while accelerating or decelerating frequently
- When leaving the engine idling for a long time, or when driving frequently through heavy traffic

CAUTION

■ Used engine oil

- Used engine oil contains potentially harmful contaminants which may cause skin disorders such as inflammation or skin cancer, so care should be taken to avoid prolonged and repeated contact. To remove used engine oil from your skin, wash thoroughly with soap and water.
- Dispose of used oil and filters only in a safe and acceptable manner. Do not dispose of used oil and filters in household trash, in sewers or onto the ground.
Call your Toyota dealer, service station or auto parts store for information concerning recycling or disposal.
- Do not leave used engine oil within the reach of children.

 NOTICE

■ **To prevent serious engine damage**

Check the oil level on regular basis.

■ **When replacing the engine oil**

- Be careful not to spill engine oil on the vehicle components.
- Avoid overfilling, or the engine could be damaged.
- Check the oil level on the dipstick every time you refill the vehicle.
- Be sure the engine oil filler cap is properly retightened.

Engine coolant

The coolant level is satisfactory if it is between the “F” and “L” lines on the reservoir when the engine is cold.

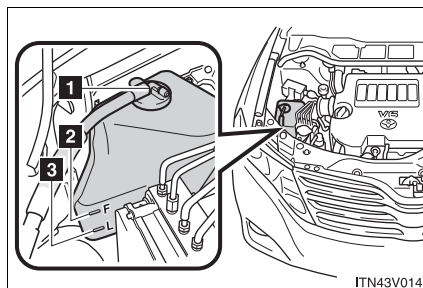

1 Reservoir cap

2 Full

3 Low

If the level is on or below the “L” line, add coolant up to the “F” line.

■ **If the coolant level drops within a short time after replenishing**

Visually check the radiator, hoses, reservoir cap, radiator cap, drain cock and water pump.

If you cannot find a leak, have your Toyota dealer pressure test the cap and check for leaks in the cooling system.

■ **Coolant selection**

Only use "Toyota Super Long Life Coolant" or similar high quality ethylene glycol based non-silicate, non-amine, non-nitrite, and non-borate coolant with long-life hybrid organic acid technology.

U.S.A.: "Toyota Super Long Life Coolant" is a mixture of 50% coolant and 50% deionized water. (Enabled: -31°F [-35°C])

Canada: "Toyota Super Long Life Coolant" is a mixture of 55% coolant and 45% deionized water. (Enabled: -44°F [-42°C])

For more details about engine coolant, contact your Toyota dealer.

 **CAUTION**

■ **When the engine is hot**

Do not remove the radiator cap.

The cooling system may be under pressure and may spray hot coolant if the cap is removed, causing serious injuries, such as burns.

 NOTICE

■ **When adding the engine coolant**

Coolant is neither plain water nor straight antifreeze. The correct mixture of water and antifreeze must be used to provide proper lubrication, corrosion protection and cooling. Be sure to read the antifreeze or coolant label.

■ **If you spill coolant**

Be sure to wash it off with water to prevent damage to parts or paint.

Radiator and condenser

Check the radiator and condenser and clear any foreign objects. If either of the above parts are extremely dirty or you are not sure of their condition, have your vehicle checked by your Toyota dealer.

 CAUTION

■ **When the engine is hot**

Do not touch the radiator or condenser as they may be hot and cause serious injuries, such as burns.

Brake fluid

■ Checking fluid level

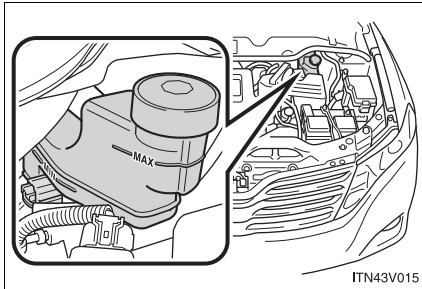

The brake fluid level should be between the “MAX” and “MIN” lines on the tank.

Make sure to check the fluid type and prepare the necessary items.

■ Adding fluid

Fluid type	FMVSS No.116 DOT 3 or SAE J1703 brake fluid
Items	Clean funnel

■ **Brake fluid can absorb moisture from the air**

Excess moisture in the fluid can cause a dangerous loss of braking efficiency. Use only newly opened brake fluid.

 **CAUTION**

■ **When filling the reservoir**

Take care because brake fluid can harm your hands or eyes and damage painted surfaces.

If fluid gets in your eyes, flush your eyes with clean water immediately.

If you still experience discomfort, see a doctor.

 **NOTICE**

■ **If the fluid level is low**

It is normal for the brake fluid level to go down slightly as the brake pads wear or when the fluid level in the accumulator is high.

If the reservoir needs frequent refilling, it may indicate a serious problem.

Battery

■ Battery exterior

Make sure that the battery terminals are not corroded and that there are no loose connections, cracks, or loose clamps.

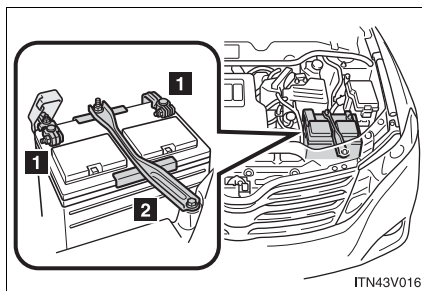

1 Terminals

2 Hold-down clamp

■ Before recharging

When recharging, the battery produces hydrogen gas which is flammable and explosive. Therefore, before recharging:

- If recharging with the battery installed on the vehicle, be sure to disconnect the ground cable.
- Make sure the power switch on the charger is off when connecting and disconnecting the charger cables to the battery.

■ After recharging the battery (vehicles with smart key system)

The engine may not start. Follow the procedure below to initialize the system.

- STEP 1** Depress the brake pedal with the shift lever in "N".
- STEP 2** Open and close any of the doors.
- STEP 3** Restart the engine.

⚠ CAUTION

■ Chemicals in the battery

A battery contains poisonous and corrosive sulfuric acid and may produce hydrogen gas which is flammable and explosive. To reduce the risk of death or serious injury, take the following precautions while working on or near battery:

- Do not cause sparks by touching the battery terminals with tools.
- Do not smoke or light a match near the battery.
- Avoid contact with eyes, skin and clothes.
- Never inhale or swallow electrolyte.
- Wear protective safety glasses when working near the battery.
- Keep children away from the battery.

 **CAUTION**

■ **Where to safely charge the battery**

Always charge the battery in an open area. Do not charge the battery in a garage or closed room where there is not sufficient ventilation.

■ **How to recharge the battery**

Only perform a slow charge (5 A or less). The battery may explode if charged at a quicker rate.

■ **Emergency measures regarding electrolyte**

- If electrolyte gets in your eyes
Flush your eyes with clean water for at least 15 minutes and get immediate medical attention. If possible, continue to apply water with a sponge or cloth while traveling to the nearest medical facility.
- If electrolyte gets on your skin
Wash the affected area thoroughly. If you feel pain or a burning sensation, seek medical attention immediately.
- If electrolyte gets on your clothes
It can soak through clothing on to your skin. Immediately take off the clothing and follow the procedure above if necessary.
- If you accidentally swallow electrolyte
Drink a large quantity of water or milk. Get emergency medical attention immediately.

 **NOTICE**

■ **When recharging the battery**

Never recharge the battery while the engine is running. Also, be sure all accessories are turned off.

Washer fluid

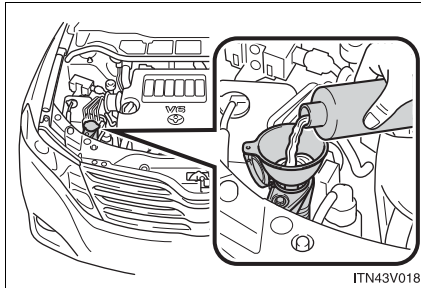

If any washer does not work or the low windshield washer fluid level warning light comes on, the washer tank may be empty. Add washer fluid.

CAUTION

■ When refilling the washer fluid

Do not refill the washer fluid when the engine is hot or running, as the washer fluid contains alcohol and may catch fire if spilled on the engine etc.

NOTICE

■ Do not use any fluid other than washer fluid

Do not use soapy water or engine antifreeze instead of washer fluid. Doing so may cause streaking on the vehicle's painted surfaces.

■ Diluting washer fluid

Dilute washer fluid with water as necessary. Refer to the freezing temperatures listed on the label of the washer fluid bottle.

4-3. Do-it-yourself maintenance Tires

Replace or rotate tires in accordance with maintenance schedules and treadwear.

■ Checking tires

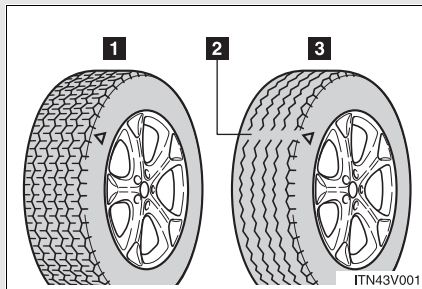

- 1 New tread
- 2 Treadwear indicator
- 3 Worn tread

The location of treadwear indicators is shown by the “TWI” or “Δ” marks, etc., molded on the sidewall of each tire.

Check spare tire condition and pressure if not rotated.

■ Tire rotation

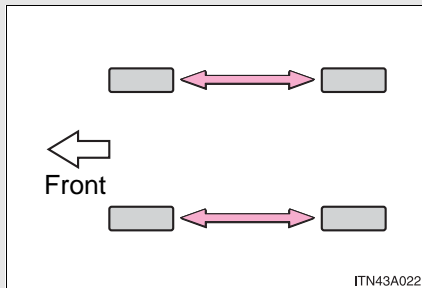

Rotate the tires in the order shown.

To equalize tire wear and extend tire life, Toyota recommends that tire rotation is carried out at the same interval as tire inspection.

■ The tire pressure warning system

Your Toyota is equipped with a tire pressure warning system that uses tire pressure warning valves and transmitters to detect low tire inflation pressure before serious problems arise. (→P. 567)

The compact spare tire is not equipped with a tire pressure warning valve and transmitter.

Installing tire pressure warning valves and transmitters

When replacing tires or wheels, tire pressure warning valves and transmitters must also be installed.

When new tire pressure warning valves and transmitters are installed, new tire pressure warning valve and transmitter ID codes must be registered in the tire pressure warning computer and the tire pressure warning system must be initialized. Have tire pressure warning valve and transmitter ID codes registered by your Toyota dealer.

Registering ID codes

The tire pressure warning valve and transmitter is equipped with a unique ID code. When replacing a tire pressure warning valve and transmitter, it is necessary to register the ID code of tire pressure warning valve and transmitter. Have the ID code registered by your Toyota dealer.

■ When to replace your vehicle's tires

Tires should be replaced if:

- You have tire damage such as cuts, splits, cracks deep enough to expose the fabric or bulges indicating internal damage
- A tire goes flat repeatedly or cannot be properly repaired due to the size or location of a cut or other damage

If you are not sure, consult with your Toyota dealer.

■ Replacing tires and wheels

If the ID code of the tire pressure warning valve and transmitter is not registered, the tire pressure warning system will not work properly. After driving for about 20 minutes, the tire pressure warning light comes on after blinking for 1 minute to indicate a system malfunction.

■ Tire life

Any tire over 6 years old must be checked by a qualified technician even if they have seldom or never been used or damage is not obvious.

■ Routine tire inflation pressure checks

The tire pressure warning system does not replace routine tire inflation pressure checks. Make sure to check tire inflation pressure as part of your routine of daily vehicle checks.

■ If the tread wears down below 0.16 in. (4 mm) on snow tires

The effectiveness of snow tires is lost.

■ Maximum load of tire

Check that the number given by dividing the maximum load by 1.10 of the replacement tire is greater than 1/2 of the Gross Axle Weight Ratings (GAWR) of either the front axle or the rear axle, whichever is greater.

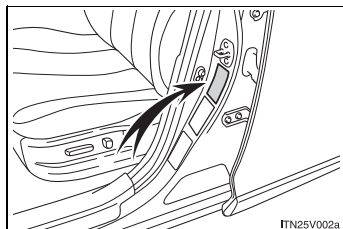

For the GAWR, see the Certification Label. For the maximum load of the tire, see the load limit at maximum cold tire inflation pressure mentioned on the sidewall of the tire. (→P. 630)

■ Tire types

1 Summer tires

Summer tires are high-speed performance tires best suited to highway driving under dry conditions. Since summer tires do not have the same traction performance as snow tires, summer tires are inadequate for driving on snow-covered or icy roads. For driving on snow-covered roads or icy roads, the use of snow tires is recommended. When installing snow tires, be sure to replace all four tires.

2 All season tires

All season tires are designed to provide better traction in snow and to be adequate for driving in most winter conditions, as well as for use year round. All season tires, however, do not have adequate traction performance compared with snow tires in heavy or loose snow. Also, all season tires fall short in acceleration and handling performance compared with summer tires in highway driving.

3 Snow tires

For driving on snow-covered roads or icy roads, we recommend using snow tires. If you need snow tires, select tires of the same size, construction and load capacity as the originally installed tires. Since your vehicle has radial tires as original equipment, make sure your snow tires also have radial construction. Do not install studded tires without first checking local regulations for possible restriction. Snow tires should be installed on all wheels. (→P. 276)

■ **Tire pressure warning system certification**

- ▶ For vehicles sold in the U.S.A., Guam, Saipan, American Samoa and Puerto Rico

FCC ID: PAXPMV107J

NOTE

This device complies with part 15 of the FCC Rules. Operation is subject to the following two conditions: (1) This device may not cause harmful interference, and (2) this device must accept any interference received, including interference that may cause undesired operation.

FCC WARNING

Changes or modifications not expressly approved by the party responsible for compliance could void the user's authority to operate the equipment.

FCC ID: HYQ13BCX

NOTE:

This device complies with part 15 of the FCC Rules. Operation is subject to the following two conditions: (1) This device may not cause harmful interference, and (2) this device must accept any interference received, including interference that may cause undesired operation.

FCC WARNING:

Changes or modifications not expressly approved by the party responsible for compliance could void the user's authority to operate the equipment.

- ▶ For vehicles sold in Canada

NOTE

Operation is subject to the following two conditions: (1) this device may not cause interference, and (2) this device must accept any interference, including interference that may cause undesired operation of the device.

⚠ CAUTION**■ When inspecting or replacing tires**

Observe the following precautions to prevent accidents. Failure to do so may cause damage to parts of the drive train, as well as dangerous handling characteristics, which may lead to an accident resulting in death or serious injury.

- Do not mix tires of different makes, models or tread patterns. Also, do not mix tires of remarkably different treadwear.
- Do not use tire sizes other than those recommended by Toyota.
- Do not mix differently constructed tires (radial, bias-belted, or bias-ply tires).
- Do not mix summer, all season and winter tires.
- Do not use tire that have been used on another vehicle.
Do not use tires if you do not know they were used previously.
- Do not tow the vehicle with the compact spare tire installed.

 NOTICE

■ **Repairing or replacing tires, wheels, tire pressure warning valves, transmitters and tire valve caps**

- When removing or fitting the wheels, tires or the tire pressure warning valve and transmitter, contact your Toyota dealer as the tire pressure warning valve and transmitter may be damaged if not handled correctly.
- When replacing tire valve caps, do not use tire valve caps other than those specified. The cap may become stuck.

■ **To avoid damage to the tire pressure warning valves and transmitters**

When a tire is repaired with liquid sealants, the tire pressure warning valve and transmitter may not operate properly. If a liquid sealant is used, contact your Toyota dealer or other qualified service shop as soon as possible. Make sure to replace the tire pressure warning valve and transmitter when replacing the tire (→P. 507)

■ **Driving on rough roads**

Take particular care when driving on roads with loose surfaces or potholes.

These conditions may cause losses in tire inflation pressure, reducing the cushioning ability of the tires. In addition driving on rough roads may cause damage to the tires themselves, as well as the vehicle's wheels and body.

■ **If tire inflation pressures become low while driving**

Do not continue driving, or your tires and/or wheels may be ruined.

4-3. Do-it-yourself maintenance Tire inflation pressure

■ Tire inflation pressure

The recommended cold tire inflation pressure and tire size is displayed on the tire and loading information label. (→P. 622)

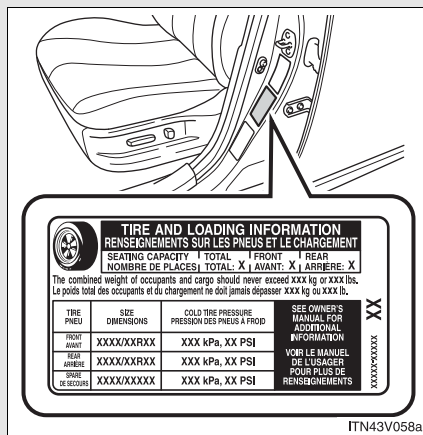

■ Inspection and adjustment procedure

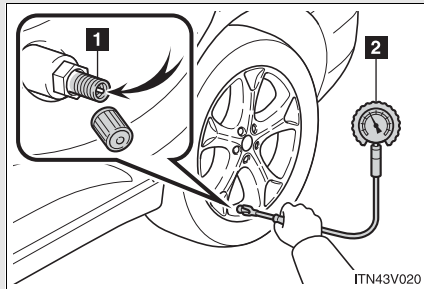

- 1 Tire valve
- 2 Tire pressure gauge

- STEP 1** Remove the tire valve cap.
- STEP 2** Press the tip of the tire pressure gauge onto the tire valve.
- STEP 3** Read the pressure using the gauge gradations.
- STEP 4** If the tire inflation pressure is not at the recommended level, adjust the pressure.
If you add too much air, press the center of the valve to deflate.
- STEP 5** After completing the tire inflation pressure measurement and adjustment, apply soapy water to the valve and check for leakage.
- STEP 6** Put the tire valve cap back on.

■ Tire inflation pressure check interval

You should check tire inflation pressure every 2 weeks, or at least once a month.

Do not forget to check the spare.

■ **Effects of incorrect tire inflation pressure**

Driving with incorrect tire inflation pressure may result in the following:

- Reduced fuel efficiency
- Reduced driving comfort and tire life
- Reduced safety
- Damage to the drive train

If a tire needs frequent refilling, have it checked by your Toyota dealer.

■ **Instructions for checking tire inflation pressure**

When checking tire inflation pressure, observe the following:

- Check only when the tires are cold.
If your vehicle has been parked for at least 3 hours or has not been driven for more than 1 mile or 1.5 km, you will get an accurate cold tire inflation pressure reading.
- Always use a tire pressure gauge.
The appearance of the tire can be misleading. In addition, tire inflation pressures that are even just a few pounds off can degrade ride and handling.
- Do not bleed or reduce tire inflation pressure after driving. It is normal for the tire inflation pressure to be higher after driving.
- Never exceed the vehicle capacity weight.
Passengers and luggage weight should be placed so that the vehicle is balanced.

 CAUTION

■ **Proper inflation is critical to save tire performance**

Keep your tires properly inflated. Otherwise, the following conditions may occur and result in an accident causing death or serious injury:

- Excessive wear
- Uneven wear
- Poor handling
- Possibility of blowouts resulting from overheated tires
- Poor sealing of the tire bead
- Wheel deformation and/or tire separation
- A greater possibility of tire damage from road hazards

 NOTICE

■ **When inspecting and adjusting tire inflation pressure**

Be sure to reinstall the tire valve caps.

Without the valve caps, dirt or moisture could get into the valve and cause air leakage, which could result in an accident. If the caps have been lost, replace them as soon as possible.

If a wheel is bent, cracked or heavily corroded, it should be replaced.

Otherwise, the tire may separate from the wheel or cause loss of handling control.

■ **Wheel selection**

When replacing wheels, care should be taken to ensure that they are equivalent to those removed in load capacity, diameter, rim width, and inset*.

Replacement wheels are available at your Toyota dealer.

*: Conventionally referred to as “offset”.

Toyota does not recommend using:

- Wheels of different sizes or types
- Used wheels
- Bent wheels that have been straightened

■ **Aluminum wheel precautions**

- Use only Toyota wheel nuts and wrenches designed for use with your aluminum wheels.
- When rotating, repairing or changing your tires, check that the wheel nuts are still tight after driving 1000 miles (1600 km).
- Be careful not to damage the aluminum wheels when using tire chains.
- Use only Toyota genuine balance weights or equivalent and a plastic or rubber hammer when balancing your wheels.

■ **When replacing wheels**

The wheels of your Toyota are equipped with tire pressure warning valves and transmitters that allow the tire pressure warning system to provide advanced warning in the event of a loss in tire inflation pressure. Whenever wheels are replaced, the tire pressure warning valves and transmitters must be installed. (→P. 507)

 **CAUTION**

■ **When replacing wheels**

- Do not use wheels that are a different size from those recommended in the Owner's Manual, as this may result in loss of handling control.
- Never use an inner tube in a leaking wheel which is designed for a tubeless tire. Doing so may result in an accident, causing death or serious injury.

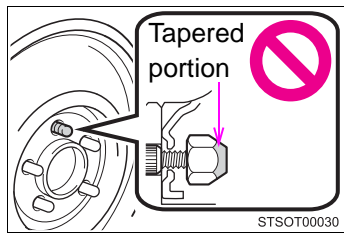
⚠ CAUTION**■ When installing the wheel nuts**

- Be sure to install the wheel nuts with the tapered ends facing inward. Installing the nuts with the tapered ends facing outward can cause the wheel to break and eventually cause the wheel to come off while driving, which could lead to an accident resulting in death or serious injury.

- Never use oil or grease on the wheel bolts or wheel nuts. Oil and grease may cause the wheel nuts to be excessively tightened, leading to bolt or disc wheel damage. In addition, the oil or grease can cause the wheel nuts to loosen and the wheel may fall off, causing an accident and resulting in death or serious injury. Remove any oil or grease from the wheel bolts or wheel nuts.

■ Use of defective wheels prohibited

Do not use cracked or deformed wheels. Doing so could cause the tire to leak air during driving, possibly causing an accident.

⚠ NOTICE**■ Replacing tire pressure warning valves and transmitters**

- Because tire repair or replacement may affect the tire pressure warning valves and transmitters, make sure to have tires serviced by your Toyota dealer or other qualified service shop. In addition, make sure to purchase your tire pressure warning valves and transmitters at your Toyota dealer.
- Ensure that only genuine Toyota wheels are used on your vehicle. Tire pressure warning valves and transmitters may not work properly with non-genuine wheels.

4-3. Do-it-yourself maintenance Air conditioning filter

The air conditioning filter must be changed regularly to maintain air conditioning efficiency.

■ Removal method

STEP 1 Vehicles with smart key system:

Turn the “ENGINE START STOP” switch off.

Vehicles without smart key system:

Turn the engine switch to the “LOCK” position.

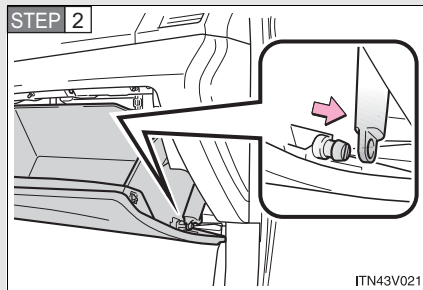

Open the glove box. Slide off the damper.

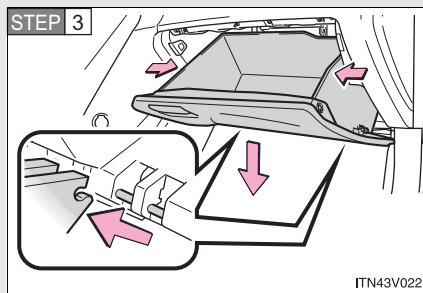

Push each side of the glove box to release the pins. Then disconnect the claws at the bottom and remove the glove box.

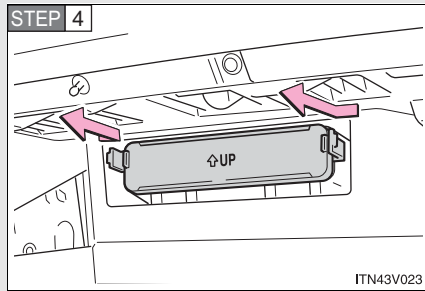

Remove the filter cover.

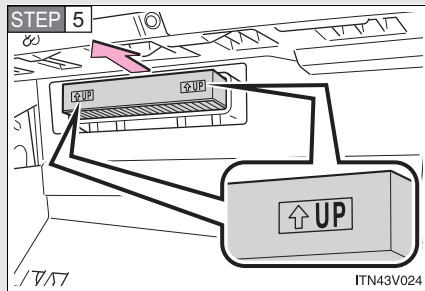

Remove the air conditioning filter and replace it with a new one.

The “↑UP” marks shown on the filter should be pointing up.

4-3. Do-it-yourself maintenance

■ **Checking interval**

Inspect and replace the air conditioning filter according to the maintenance schedule. In dusty areas or areas with heavy traffic flow early replacement may be required. (For scheduled maintenance information, refer to the “Scheduled Maintenance Guide”, “Owner’s Manual Supplement”.)

■ **If air flow from the vents decreases dramatically**

The filter may be clogged. Check the filter and replace if necessary.

 NOTICE

<h4>■ To prevent damage to the system</h4>

<p>When using the air conditioning system, make sure that a filter is always installed.</p>

4-3. Do-it-yourself maintenance

Key battery

Replace the battery with a new one if it is discharged.

■ **You will need the following items:**

- Flathead screwdriver (To prevent damage to the key, cover the tip of the screwdriver with rag.)
- Small Phillips-head screwdriver
- Lithium battery
Vehicles with smart key system: CR1632
Vehicles without smart key system: CR2025

■ **Replacing the battery (vehicles with smart key system)**

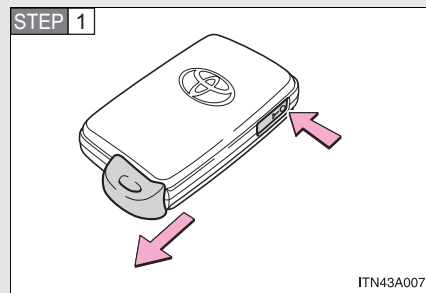

Take out the mechanical key.

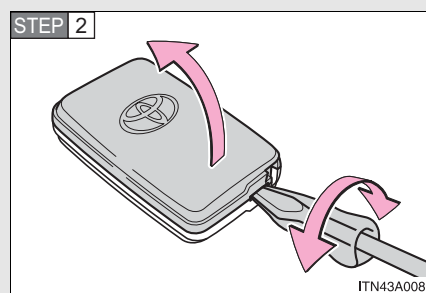

Remove the cover.

4-3. Do-it-yourself maintenance

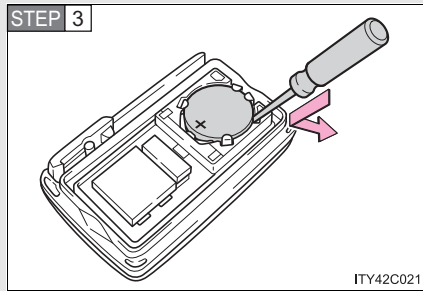

Remove the depleted battery.

Insert a new battery with the "+" terminal facing up.

■ Replacing the battery (vehicles without smart key system)

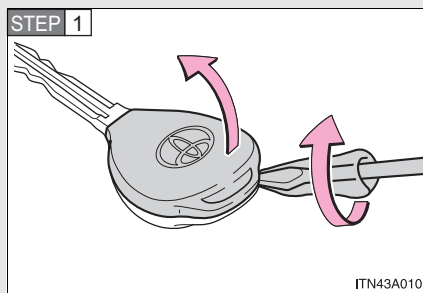

Remove the cover.

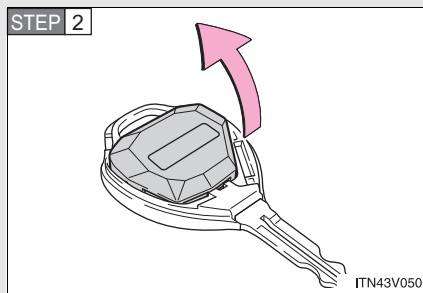

Remove the module.

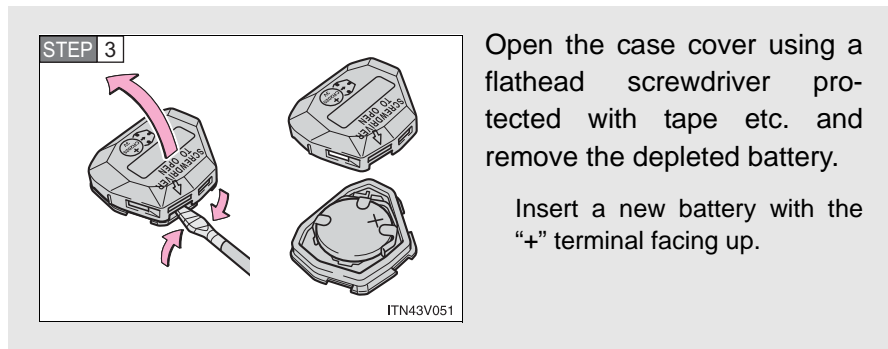

■ **If the electronic key battery is discharged**

The following symptoms may occur.

- The smart key system and wireless remote control will not function properly.
- The operational range is reduced.

■ **Use a CR1632 (vehicles with smart key system), or CR2025 (vehicles without smart key system) lithium battery**

- Batteries can be purchased at your Toyota dealer, jewelers, or camera stores.
- Replace only with the same or equivalent type recommended by a Toyota dealer.
- Dispose of used batteries according to the local laws.

4-3. Do-it-yourself maintenance

CAUTION

■ **Removed battery and other parts**

These parts are small and if swallowed by a child they can cause choking. Keep away from children. Failure to do so could result in death or serious injury.

NOTICE

■ **For normal operation after replacing the battery**

Observe the following precautions to prevent accidents.

- Always work with dry hands.
Moisture may cause the battery to rust.
- Do not touch or move any other components inside the electronic key.
- Do not bend the battery terminals.

4-3. Do-it-yourself maintenance Checking and replacing fuses

If any of the electrical components do not operate, a fuse may have blown. If this happens, check and replace the fuses as necessary.

- STEP 1** Vehicles with smart key system:
Turn the “ENGINE START STOP” switch off.
Vehicles without smart key system:
Turn the engine switch to the “LOCK” position.

STEP 2 Open the fuse box cover.

► Engine compartment

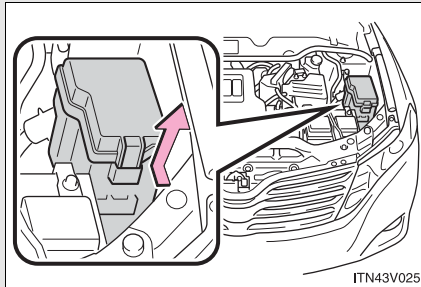

Push the tab in and lift the lid off.

► Driver's side instrument panel

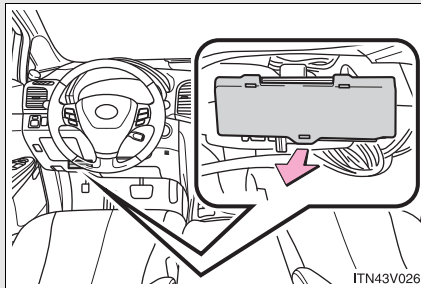

Remove the lid.

4-3. Do-it-yourself maintenance

STEP 3 After a system failure, see “Fuse layout and amperage ratings” (→P. 529) for details about which fuse to check.

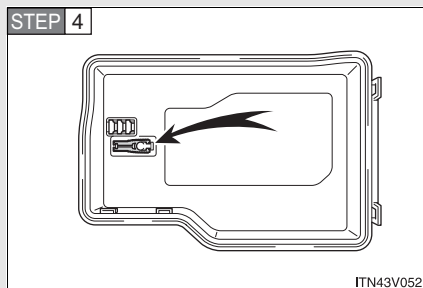

Remove the fuse with the pull-out tool.

STEP 5 Check if the fuse has blown.

► Type A

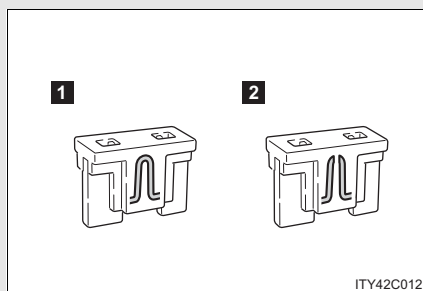

1 Normal fuse

2 Blown fuse

Replace it with one of an appropriate amperage rating. The amperage rating can be found on the fuse box lid.

► Type B

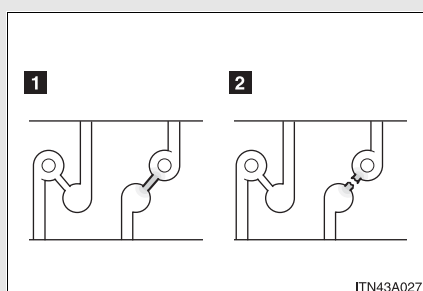

1 Normal fuse

2 Blown fuse

Contact your Toyota dealer.

Fuse layout and amperage ratings

■ Engine compartment

► Fuse block

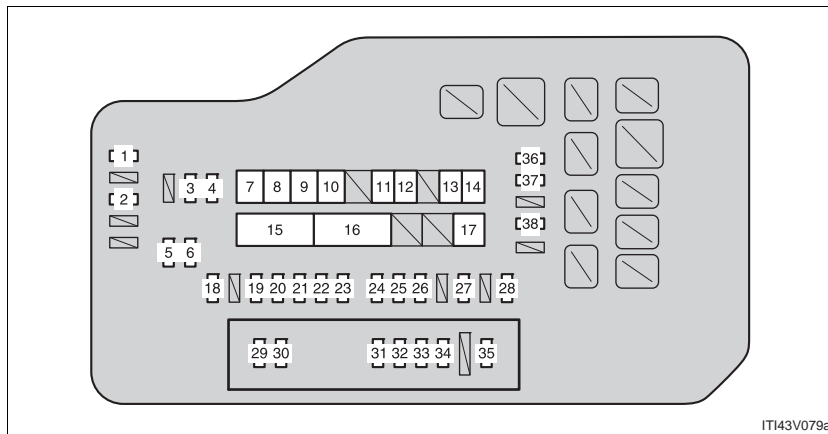

► Back of the cover

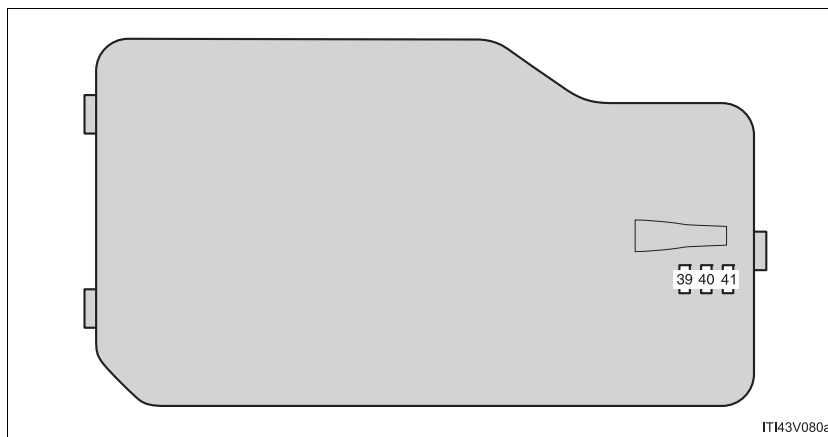

4-3. Do-it-yourself maintenance

Fuse		Ampere	Circuit
1	MIRROR	10 A	Outside rear view mirrors (driving position memory)
2	DEICER	20 A	Windshield wiper de-icer
3	INJ NO.1	15 A	Multiport fuel injection system/ sequential multiport fuel injection system
4	INJ NO.2	15 A	Igniter system
5	EFI NO.2	15 A	Multiport fuel injection system/ sequential multiport fuel injection system
6	EFI NO.3	10 A	Multiport fuel injection system/ sequential multiport fuel injection system
7	HEATER	50 A	Air conditioning system
8	VSC NO.1	50 A	Anti-lock brake system, vehicle stability control system
9	FAN MAIN*1	50 A	Electric cooling fan
10	VSC NO.2	30 A	Anti-lock brake system, vehicle stability control system
11	CDS FAN*2	30 A	Electric cooling fan
12	RDI FAN*2	30 A	Electric cooling fan
13	LG/CLOSER	30 A	Power back door
14	RR DEF	30 A	Rear window defogger
15	ALT	140 A*3 or 120 A*3	Charging system, HEATER, ABS NO.1, FAN MAIN, ABS NO.2, PBD, RR DEF, MIR HTR, DEICER
16	EPS	80 A	Electric power steering
17	ST	30 A	Starting system
18	BI-XENON	10 A	Discharge headlights (high beam control)
19	DOOR NO.1	20 A	Power door lock system
20	STRG LOCK	20 A	Steering lock system
21	SEC HORN	7.5 A	SEC HORN
22	AM2	7.5 A	Multiplex communication system, starting system
23	ALT-S	7.5 A	Charging system

Fuse		Ampere	Circuit
24	EFI NO.1	10 A	Smart key system, multiport fuel injection system/sequential multiport fuel injection system, automatic transmission
25	ETCS	10 A	Multiport fuel injection system/sequential multiport fuel injection system, electronic throttle control system
26	TURN-HAZ	15 A	Turn signal lights
27	IG2	25 A	INJ NO.1, INJ NO.2, SRS airbag system
28	AMP	20 A	Audio system
29	A/F*1	20 A	Air fuel ratio sensor
	EFI MAIN*2	20 A	EFI NO.2, EFI NO.3
30	HORN	10 A	Horn
31	H-LP LO (LH)	15 A	Left-hand headlight (low beam)
32	H-LP LO (RH)	15 A	Right-hand headlight (low beam)
33	H-LP HI (LH)	15 A	Left-hand headlight (high beam)
34	H-LP HI (RH)	15 A	Right-hand headlight (high beam)
35	EFI MAIN*1	25 A	EFI NO.2, EFI NO.3
	EFI NO.4*2	20 A	Air fuel ratio sensor
36	DOME	7.5 A	Personal/interior lights, vanity lights, engine switch light, door courtesy lights, power back door, gauges and meters

4-3. Do-it-yourself maintenance

Fuse		Ampere	Circuit
37	ECU-B	10 A	Gauges and meters, clock, audio system, main body ECU, wireless remote control, smart key system, power back door, front passenger occupant classification system
38	RADIO-B	20 A	Audio system, Entune Premium Audio with Navigation
39	SPARE	7.5 A	Spare fuse
40	SPARE	15 A	Spare fuse
41	SPARE	25 A	Spare fuse

*1: Vehicles with 2GR-FE engine

*2: Vehicles with 1AR-FE engine

*3: Replace the fuse with one of the same ampere rating as the original.

■ Driver's side instrument panel

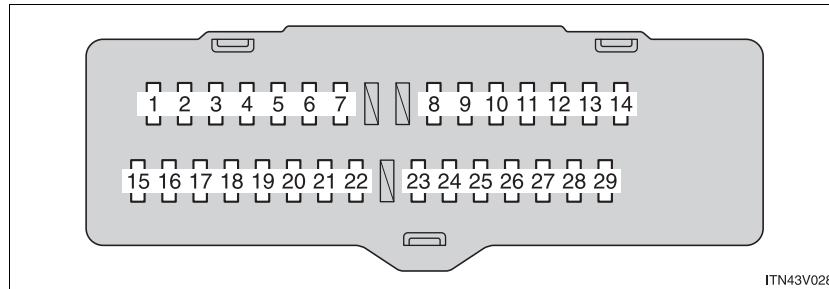

Fuse	Ampere	Circuit
1	20 A	Power windows
2	20 A	Power windows
3	20 A	Power windows
4	15 A	Fog lights
5	7.5 A	On-board diagnosis system
6	20 A	Power windows
7	10 A	Stop lights, vehicle stability control system
8	7.5 A	Starting system
9	7.5 A	Steering sensor, air conditioning system, power windows
10	7.5 A	Active Torque Control 4WD

4-3. Do-it-yourself maintenance

Fuse		Ampere	Circuit
11	SEAT HTR	20 A	Seat heaters
12	S/ROOF	25 A	Electric moon roof
13	TAIL	10 A	Side marker lights, tail lights, license plate light
14	PANEL	5 A	Emergency flashers, audio system, clock, instrument panel light control, glove box light, console box light, steering switches, outside rear view mirror defoggers, seat heaters, vehicle stability control system, shift lever light
15	ECU-IG NO.1	10 A	Multiplex communication system, electric moon roof, power back door, seat heaters, Active Torque Control 4WD, audio system, Automatic High Beam
16	RR WASHER	15 A	Rear window washer
17	A/C NO.2	10 A	Air conditioning system
18	FR WASHER	20 A	Windshield washer
19	ECU-IG NO.2	7.5 A	Vehicle stability control system, automatic headlight leveling system, yaw rate & G sensor, steering sensor, shift lock system, tire pressure warning system, automatic transmission, electric power steering

Fuse		Ampere	Circuit
20	GAUGE NO.1	10 A	Entune Premium Audio with Navigation, back-up lights, charging system, emergency flashers, multi-information display
21	FR WIPER	30 A	Windshield wipers
22	RR WIPER	15 A	Rear window wiper
23	IGN	10 A	Multipoint fuel injection system/ sequential multipoint fuel injection system, steering lock system, smart key system, SRS airbag system, front passenger occupant classification system
24	GAUGE NO.2	7.5 A	Gauges and meters, multi-information display, multiplex communication system
25	ECU-ACC	7.5 A	Power rear view mirrors
26	SHIFT LOCK	7.5 A	Shift lock system
27	PWR OUTLET NO.1	15 A	Power outlets
28	RADIO NO.2	7.5 A	Audio system
29	MIR HTR	10 A	Outside rear view mirror defoggers

■ **After a fuse is replaced**

- If the lights do not turn on even after the fuse has been replaced, a bulb may need replacement. (→P. 537)
- If the replaced fuse blows again, have the vehicle inspected by your Toyota dealer.

■ **If there is an overload in the circuits**

The fuses are designed to blow, protecting the wiring harness from damage.

 **CAUTION**

■ **To prevent system breakdowns and vehicle fire**

Observe the following precautions.

Failing to do so may cause damage to the vehicle, and possibly a fire or injury.

- Never use a fuse of a higher amperage rating than indicated, or use any other object in place of a fuse.
- Always use a genuine Toyota fuse or equivalent.
Never replace a fuse with a wire, even as a temporary fix.
- Do not modify fuses or the fuse box.

 **NOTICE**

■ **Before replacing fuses**

Have the cause of electrical overload determined and repaired by your Toyota dealer.

4-3. Do-it-yourself maintenance

Light bulbs

You may replace the following bulbs yourself. The difficulty level of replacement varies depending on the bulb. If necessary bulb replacement seems difficult to perform, contact your Toyota dealer.

For more information about replacing other light bulbs, contact your Toyota dealer.

■ Prepare a replacement light bulb.

Check the wattage of the light bulb being replaced. (→P. 624)

■ Turn the power back door main switch off. (vehicles with power back door)

→P. 59

■ Front bulb locations

▶ Vehicles with halogen headlights

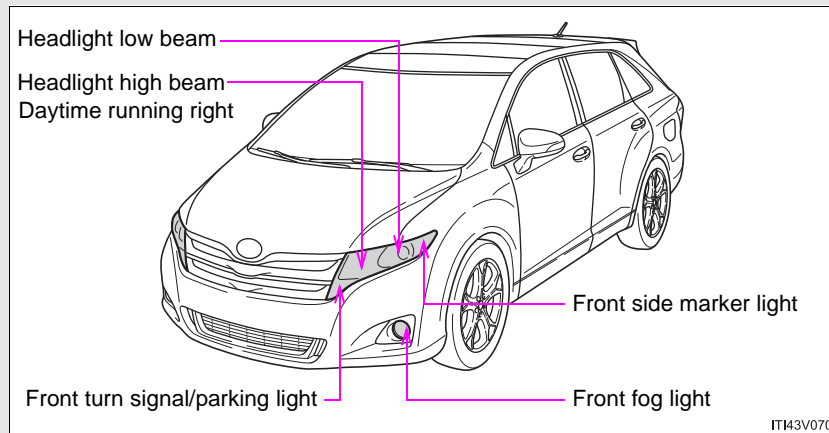

► Vehicles with discharge headlights

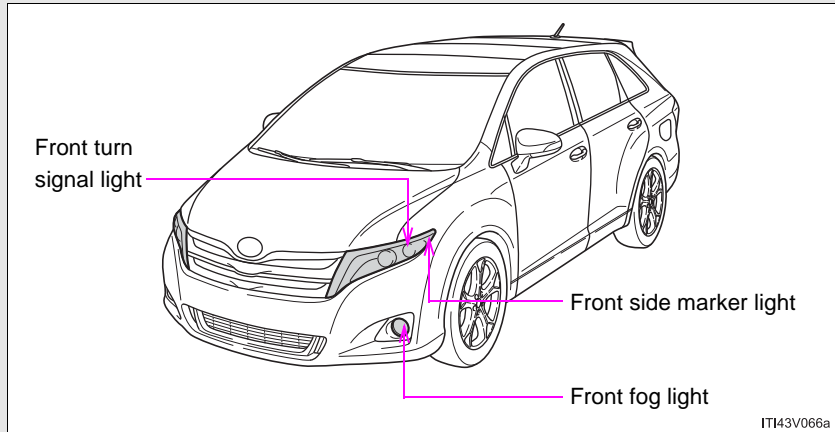

■ Rear bulb locations

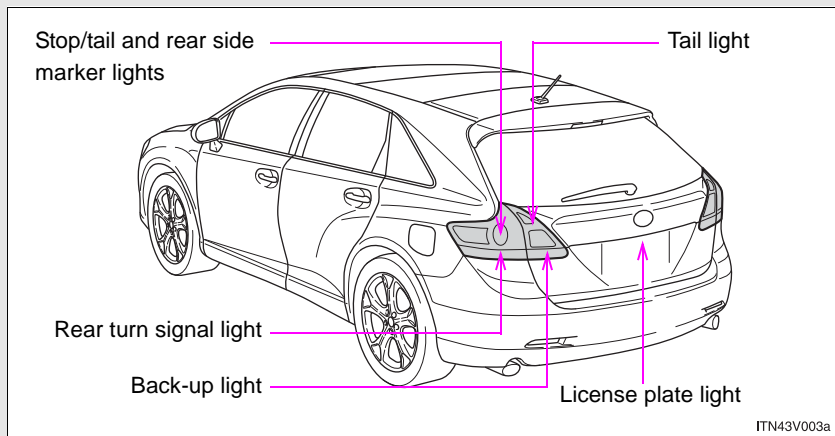

Replacing light bulbs

■ Headlight low beams (vehicles with halogen headlights)

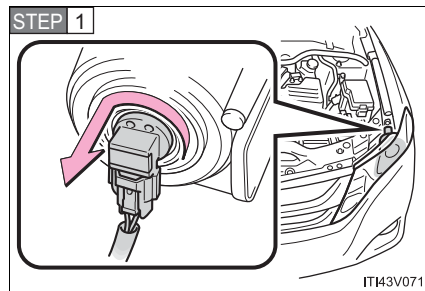

Turn the bulb base counterclockwise.

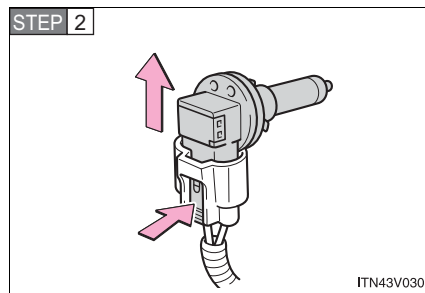

Unplug the connector while pushing the lock release.

4-3. Do-it-yourself maintenance

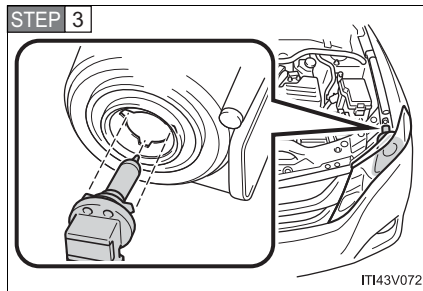

Replace the light bulb, and install the bulb base.

Align the 3 tabs on the light bulb with the mounting, and insert.

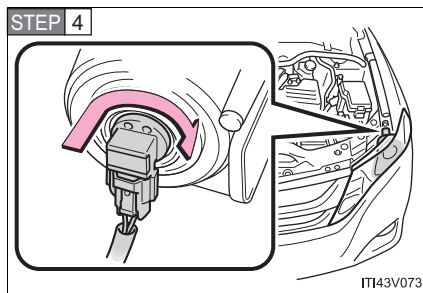

Turn and secure the bulb base.

Shake the bulb base gently to check that it is not loose, turn the headlights on once and visually confirm that no light is leaking through the mounting.

■ **Headlight high beams and daytime running lights (vehicles with halogen headlights)**

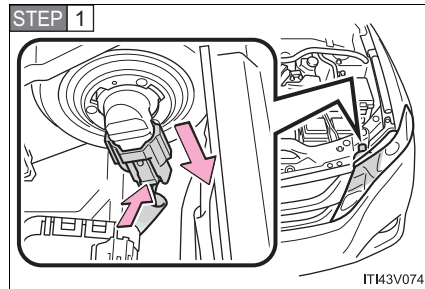

Unplug the connector while pushing the lock release.

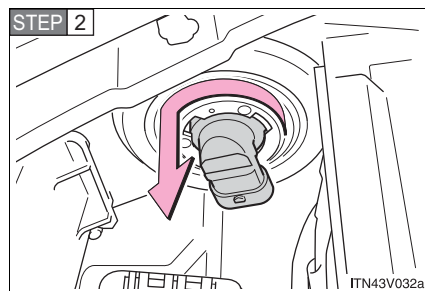

Turn the bulb base counterclockwise.

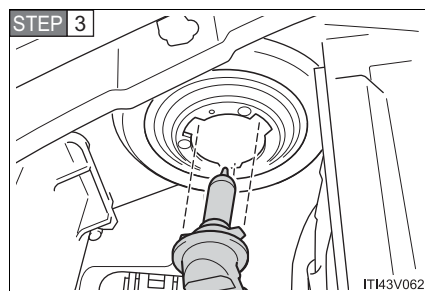

Replace the light bulb, and install the light bulb.

Align the 3 tabs on the light bulb with the mounting, and insert.

4-3. Do-it-yourself maintenance

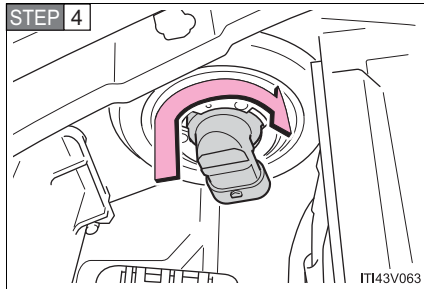

Turn and secure the bulb base.

STEP 5 Install the connector.

Shake the bulb base gently to check that it is not loose, turn the headlights on once and visually confirm that no light is leaking through the mounting.

■ Front fog lights

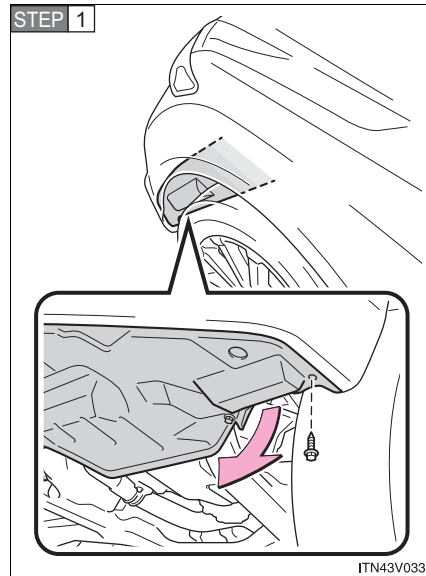

Remove the engine under cover bolt and pull down the engine under cover.

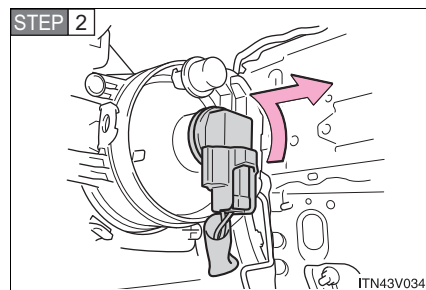

Turn the bulb base counterclockwise.

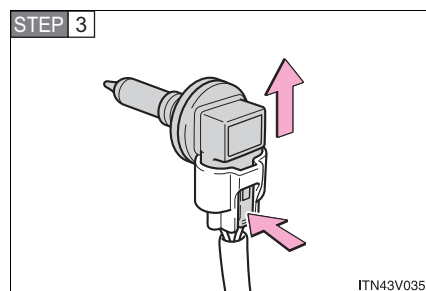

Unplug the connector while pushing the lock release.

4-3. Do-it-yourself maintenance

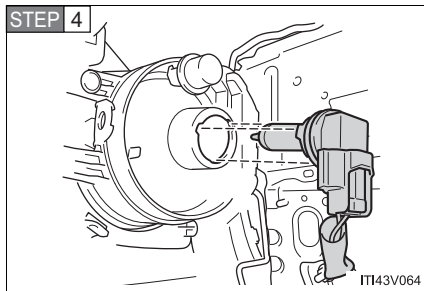

Replace the light bulb, and install the bulb base.

Align the 3 tabs on the light bulb with the mounting, and insert.

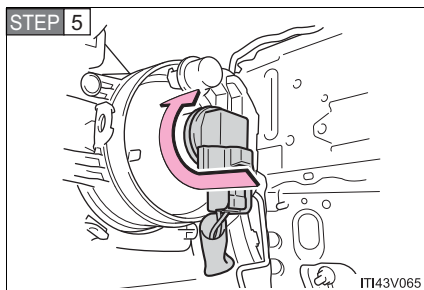

Turn and secure the bulb base.

Shake the bulb base gently to check that it is not loose, turn the front fog lights on once and visually confirm that no light is leaking through the mounting.

■ Front turn signal/parking lights (vehicles with halogen headlights)

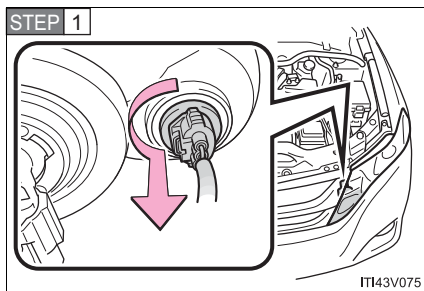

Turn the bulb base counterclockwise.

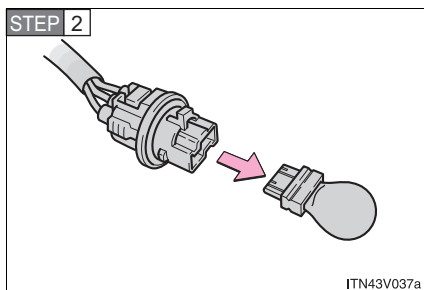

Remove the light bulb.

■ **Front turn signal lights (vehicles with discharge headlights)**

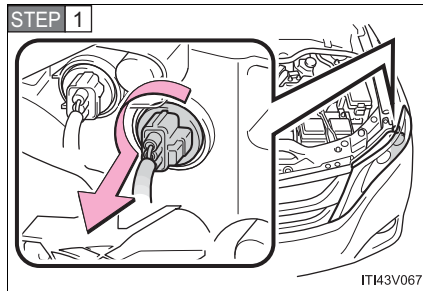

Turn the bulb base counterclockwise.

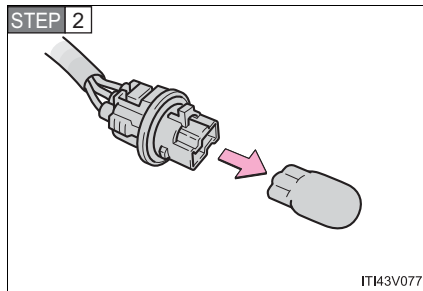

Remove the light bulb.

4-3. Do-it-yourself maintenance

■ Front side marker lights

STEP 1 Turn the bulb base counterclockwise.

▶ Vehicles with halogen headlights

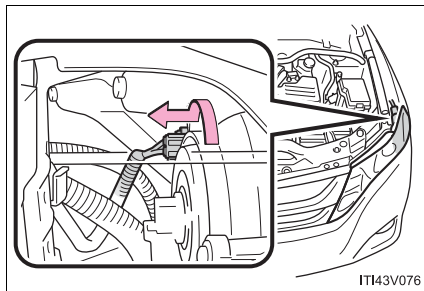

▶ Vehicles with discharge headlights

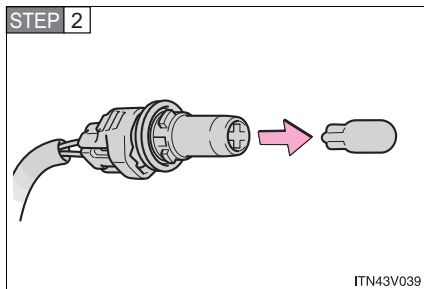
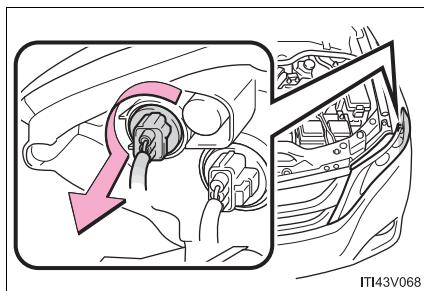

Remove the light bulb.

■ Rear turn signal lights, stop/tail and rear side marker lights

▶ Left side

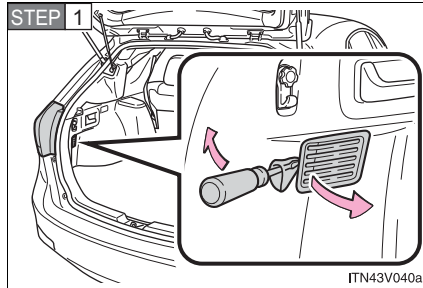

Open the back door and remove the cover.

To protect the cover, place a rag between the flathead screwdriver and cover as shown in the illustrations.

▶ Right side

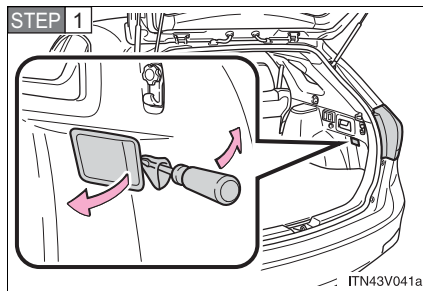

Open the back door and remove the cover.

To protect the cover, place a rag between the flathead screwdriver and cover as shown in the illustrations.

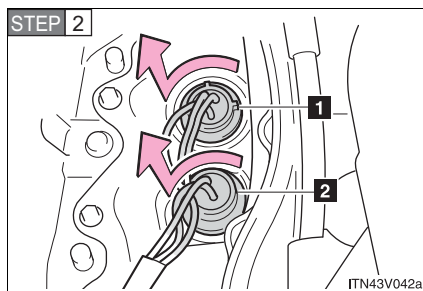

Turn the bulb base counterclockwise.

- 1 Stop/tail and rear side marker lights
- 2 Rear turn signal light

4-3. Do-it-yourself maintenance

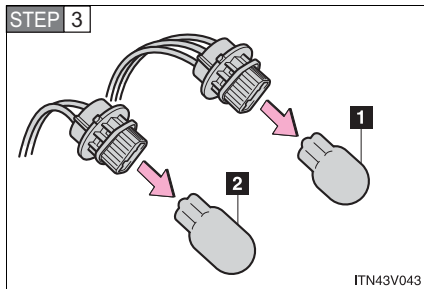

Remove the light bulb.

- 1** Stop/tail and rear side marker lights
- 2** Rear turn signal light

■ Tail and back-up lights

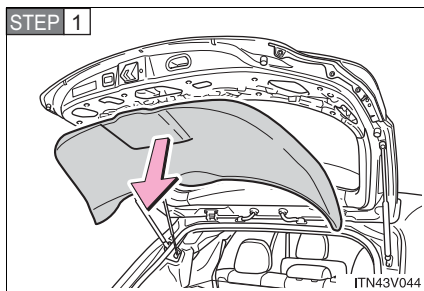

Open the back door and remove the trim board.

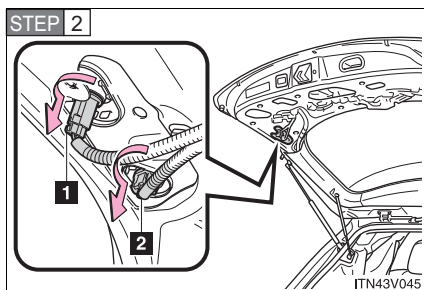

Turn the bulb base counterclockwise.

- 1** Back-up light
- 2** Tail light

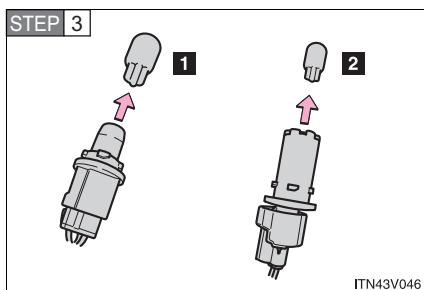

Remove the light bulb.

- 1** Back-up light
- 2** Tail light

■ License plate light

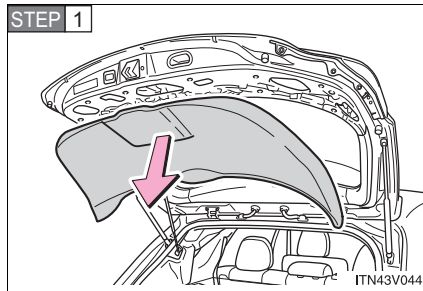

Open the back door and remove the trim board.

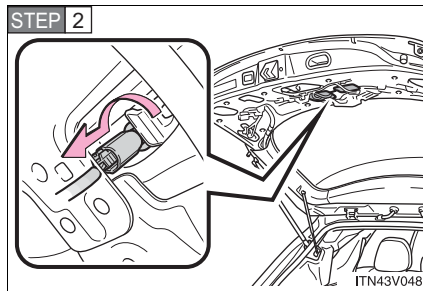

Turn the bulb base counterclockwise.

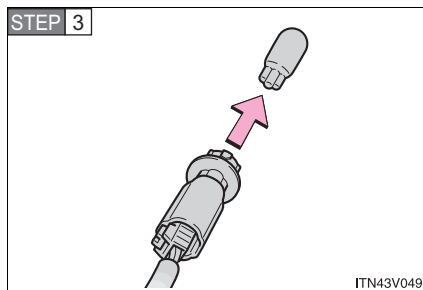

Remove the light bulb.

4-3. Do-it-yourself maintenance

■ Bulbs other than the above

If any of the bulbs listed below has burnt out, have your Toyota dealer replace it.

- Headlight low and high beams (vehicles with discharge headlights)
- Daytime running/parking lights (vehicles with discharge headlights)
- High mounted stoplight
- Foot lights
- Side turn signal lights

■ Condensation build-up on the inside of the lens

Temporary condensation build-up on the inside of the headlight lens does not indicate a malfunction. Contact your Toyota dealer for more information in the following situations:

- Large drops of water are built up on the inside of the lens.
- Water has built up inside the headlight.

■ LED light bulbs

The daytime running/parking lights (vehicles with discharge headlights), high mounted stoplight and foot lights consist of a number of LEDs. If any LEDs burn out, take your vehicle to your Toyota dealer to have the light replaced.

■ High-intensity discharge (HID) headlights (if equipped)

If voltage to the high-intensity discharge bulbs is insufficient, the light may not come on, or may go out temporarily. The high-intensity discharge bulbs will come on when normal power is restored.

⚠ CAUTION**■ Replacing light bulbs**

- Turn off the lights. Do not attempt to replace the bulb immediately after turning off the lights.
The bulbs become very hot and may cause burns.
- Do not touch the glass portion of the light bulb with bare hands. When it is unavoidable to hold the glass portion, use and hold with a clean dry cloth to avoid getting moisture and oils on the bulb.
Also, if the bulb is scratched or dropped, it may blow out or crack.
- Fully install light bulbs and any parts used to secure them. Failure to do so may result in heat damage, fire, or water entering the headlight unit. This may damage the headlights or cause condensation to build up on the lens.

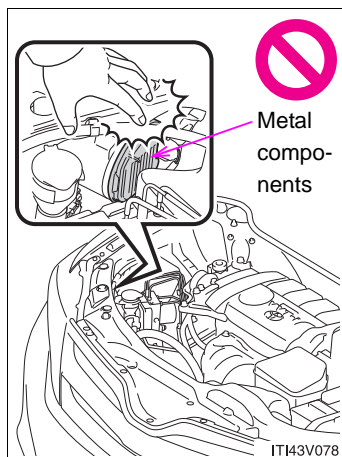

- Vehicles with discharge headlights:
While the headlights are turned on, and for a short time after they have been turned off, metal components at the rear of the headlight assembly will be extremely hot. To prevent burns, do not touch these metal components until you are certain they have cooled down.

 CAUTION

■ **Discharge headlights (if equipped)**

- Contact your Toyota dealer before replacing the discharge headlights (including light bulbs).
- Do not touch the discharge headlight's high voltage socket when the headlights are turned on.
An extremely high voltage of 30000 V will be discharged and could result in serious injury or death by electric shock.
- Do not attempt to take apart or repair the low beam discharge headlight bulbs, connectors, power supply circuits, or related components.
Doing so could result in electric shock and serious injury or death.

■ **To prevent damage or fire**

Make sure bulbs are fully seated and locked.

When trouble arises

5

5-1. Essential information

Emergency flashers	554
If your vehicle needs to be towed	555
If you think something is wrong	561
Fuel pump shut off system	563

5-2. Steps to take in an emergency

If a warning light turns on or a warning buzzer sounds... ..	564
If a warning message is displayed.....	578
If you have a flat tire.....	579
If the engine will not start	590
If the shift lever cannot be shifted from "P"	593
If you lose your keys	594
If the electronic key does not operate properly (vehicles with smart key system).....	595
If the battery is discharged	598
If your vehicle overheats	603
If the vehicle becomes stuck	606
If your vehicle has to be stopped in an emergency	608

5-1. Essential information Emergency flashers

The emergency flashers are used to warn other drivers when the vehicle has to be stopped in the road due to a breakdown, etc.

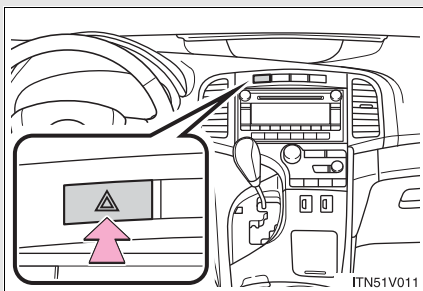

Press the switch.

All the turn signal lights will flash. To turn them off, press the switch once again.

■ Emergency flashers

If the emergency flashers are used for a long time while the engine is not operating, the battery may discharge.

5-1. Essential information

If your vehicle needs to be towed

If towing is necessary, we recommend having your vehicle towed by your Toyota dealer or commercial towing service, using a lift-type truck or a flatbed truck.

Use a safety chain system for all towing, and abide by all state/provincial and local laws.

▶ 2WD models

If towing your vehicle with a wheel-lift type truck from the front, the vehicle's rear wheels and axles must be in good conditions. (→P. 556, 558)

If they are damaged, use a towing dolly or flatbed truck.

▶ AWD models

If towing your vehicle with a wheel-lift type truck, use a towing dolly. (→P. 556, 558)

Situations needs to contact dealers before towing

The following may indicate a problem with your transmission. Contact your Toyota dealer or commercial towing service before towing.

- The engine is running, but the vehicle will not move.
- The vehicle makes an abnormal sound.

Towing with a sling-type truck

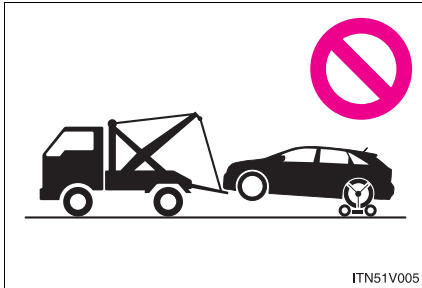

Do not tow with a sling-type truck to prevent body damage.

Towing with a wheel lift-type truck

- ▶ From the front (2WD models)

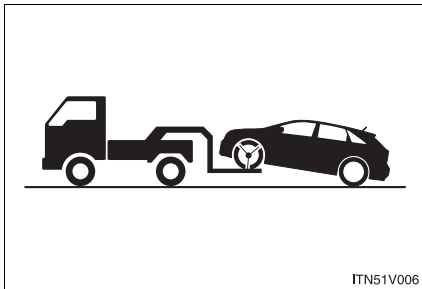

Release the parking brake.

- ▶ From the front (AWD models)

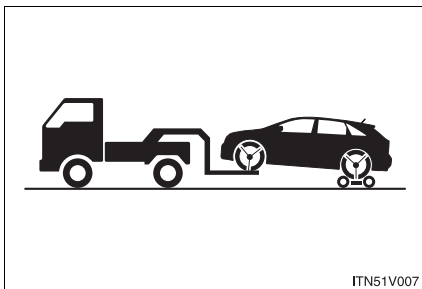

Use a towing dolly under the rear wheels.

► From the rear

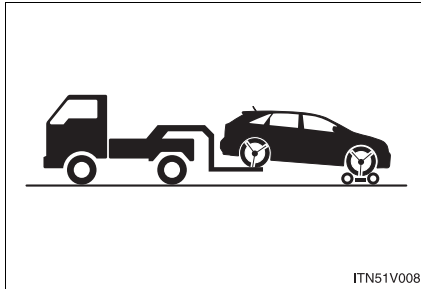

Use a towing dolly under the front wheels.

Using a flatbed truck

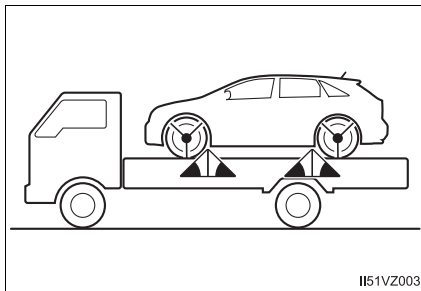

If you use chains or cables to tie down your vehicle, the angles shaded in black must be 45°.

Do not overly tighten the tie downs or the vehicle may be damaged.

■ **While towing**

If the engine is not running, the power assist for the brakes and steering will not function, making steering and braking more difficult.

■ **Wheel nut wrench**

Wheel nut wrench is installed in your luggage compartment. (→P. 579)

⚠ CAUTION

Observe the following precautions.
Failure to do so may result in death or serious injury.

■ When towing the vehicle

▶ 2WD models

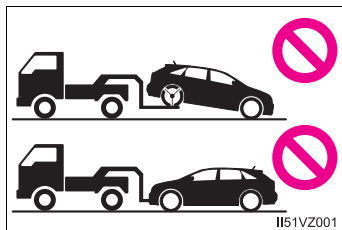

Be sure to transport the vehicle with the front wheels raised or with all four wheels raised off the ground. If the vehicle is towed with the front wheels contacting the ground, the drivetrain and related parts may be damaged.

▶ AWD models

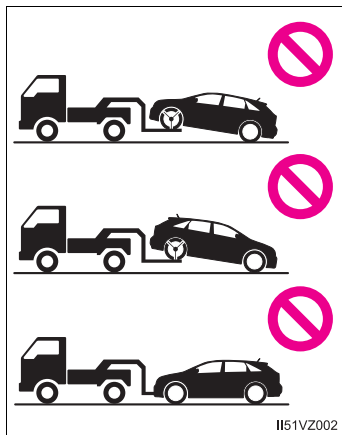

Be sure to transport the vehicle with all four wheels raised off the ground. If the vehicle is towed with the tires contacting the ground, the drivetrain or related parts may be damaged, the vehicle may fly off the truck.

 CAUTION■ **While towing**

- When towing using cables or chains, avoid sudden starts, etc. which place excessive stress on the towing eyelets, cables or chains. The towing eyelets, cables or chains may become damaged, broken debris may hit people and cause serious damage.
- Vehicles with smart key system:
Do not turn the “ENGINE START STOP” switch off.
There is a possibility that the steering wheel is locked and cannot be operated.
- Vehicles without smart key system:
Do not turn the engine switch to the “LOCK” position.
There is a possibility that the steering wheel is locked and cannot be operated.

 NOTICE

■ **To prevent damage to the vehicle when towing using a wheel-lift type truck (2WD models)**

When raising the vehicle from the rear, ensure adequate ground clearance for towing at the opposite end of the raised vehicle. Without adequate clearance, the vehicle could be damaged while being towed from the rear.

■ **To prevent body damage when towing with a sling-type truck**

Do not tow with a sling-type truck, either from the front or rear.

■ **Recreational towing (behind motor home, etc.)**

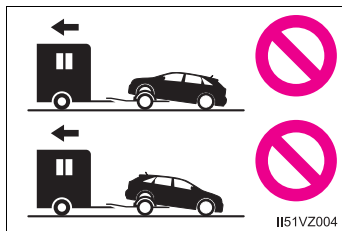

Never dinghy tow your vehicle to prevent causing serious damage to the Active Torque Control 4WD system (AWD models) and transmission. (→P. 302)

5-1. Essential information

If you think something is wrong

If you notice any of the following symptoms, your vehicle probably needs adjustment or repair. Contact your Toyota dealer as soon as possible.

■ Visible symptoms

- Fluid leaks under the vehicle
(Water dripping from the air conditioning after use is normal.)
- Flat-looking tires or uneven tire wear
- Engine coolant temperature gauge needle continually points higher than normal

■ Audible symptoms

- Changes in exhaust sound
- Excessive tire squeal when cornering
- Strange noises related to the suspension system
- Pinging or other noises related to the engine

5-1. Essential information

■ Operational symptoms

- Engine missing, stumbling or running rough
- Appreciable loss of power
- Vehicle pulls heavily to one side when braking
- Vehicle pulls heavily to one side when driving on a level road
- Loss of brake effectiveness, spongy feeling, pedal almost touches the floor

5-1. Essential information

If noise can be heard from under vehicle

Approximately five hours after the engine is turned off, you may hear sound coming from under the vehicle for several minutes. This is the sound of a fuel evaporation leakage check and, it does not indicate a malfunction.

5-1. Essential information

Fuel pump shut off system

To minimize the risk of fuel leakage when the engine stalls or an air-bag inflates upon collision, the fuel pump shut off system stops supplying fuel to the engine.

Follow the procedure below to restart the engine after the system is activated.

▶ Vehicles with smart key system

STEP 1 Turn the “ENGINE START STOP” switch to ACCESSORY mode or off.

STEP 2 Restart the engine.

▶ Vehicles without smart key system

STEP 1 Turn the engine switch to the “ACC” or “LOCK” position.

STEP 2 Restart the engine.

 **NOTICE**

■ **Before starting the engine**

Inspect the ground under the vehicle.

If you find that fuel has leaked on to the ground, the fuel system has been damaged and is in need of repair. Do not restart the engine.



5-2. Steps to take in an emergency

If a warning light turns on or a warning buzzer sounds...

Calmly perform the following actions if any of the warning lights turn on or flash. If a light turns on or flashes, but then turns off, this does not necessarily indicate a malfunction in the system.

Stop the vehicle immediately. Continuing to drive the vehicle may be dangerous.

The following warning indicates a possible problem in the brake system. Immediately stop the vehicle in a safe place and contact your Toyota dealer.



Warning light	Warning light/Details
 (U.S.A.)	Brake system warning light (warning buzzer)* <ul style="list-style-type: none">• Low brake fluid• Malfunction in the brake system This light also comes on when the parking brake is not released. If the light turns off after the parking brake is fully released, the system is operating normally.
 (Canada)	

*: Parking brake engaged warning buzzer:

A buzzer will sound if the vehicle is driven at a speed of approximately 3 mph (5 km/h) or more.

Stop the vehicle immediately.

The following warning indicates the possibility of damage to the vehicle that may lead to an accident. Immediately stop the vehicle in a safe place and contact your Toyota dealer.









Warning light	Warning light/Details
	Charging system warning light Malfunction in the vehicle's charging system.
	Low engine oil pressure warning light Abnormal level of engine oil pressure. This warning light may turn on if the level of engine oil declines. The light should turn off after checking the oil and adding oil if necessary.

Have the vehicle inspected immediately.

Failing to investigate the cause of the following warnings may lead to the system operating abnormally and possibly cause an accident. Have the vehicle inspected by your Toyota dealer immediately.





Warning light	Warning light/Details
	Malfunction indicator lamp Malfunction in: <ul style="list-style-type: none"> • The emission control system; • The electronic engine control system; • The electronic throttle control system; or • The electronic automatic transmission control system.

5-2. Steps to take in an emergency





Warning light	Warning light/Details
	<p>SRS warning light Malfunction in:</p> <ul style="list-style-type: none"> • The SRS airbag system; • The front passenger occupant classification system; or • The seat belt pretensioner system.
<p> (U.S.A.)</p> <p> (Canada)</p>	<p>ABS warning light Malfunction in:</p> <ul style="list-style-type: none"> • The ABS; or • The brake assist system.
	<p>Slip indicator light Indicates a malfunction in:</p> <ul style="list-style-type: none"> • The VSC system; • The TRAC system; or • The hill-start assist control system. <p>The light will flash when the VSC, the TRAC or the hill-start assist control system is operating.</p>
 (if equipped)	<p>Automatic headlight leveling system warning light Malfunction in the automatic headlight leveling system.</p>
	<p>Electric power steering system warning light Indicates a malfunction in the EPS (Electric Power Steering) system.</p>
 (Flashes)	<p>Cruise control indicator Indicates a malfunction in the cruise control system.</p>
 (Flashes)	<p>Automatic High Beam indicator light (if equipped) Indicates a malfunction in the Automatic High Beam system</p>

Follow the correction procedures.

After taking the specified steps to correct the suspected problem, check that the warning light turns off.

Warning light	Warning light/Details	Correction procedure
	Open door warning light (warning buzzer)*1 A door is not fully closed.	Check that all doors are closed.
	Driver's seat belt reminder light (warning buzzer)*2 Warns the driver to fasten his/her seat belt.	Fasten the seat belt.
 (On the center display)	Front passenger's seat belt reminder light (warning buzzer)*2 Warns the front passenger to fasten his/her seat belt.	Fasten the seat belt.
	Tire pressure warning light	
	When the light comes on: Low tire inflation pressure such as • Natural causes (→P. 573) • Flat tire (→P. 579)	Adjust the tire inflation pressure to the specified level. The light will turn off after a few minutes. In case the light does not turn off even if the tire inflation pressure is adjusted, have the system checked by your Toyota dealer.
	When the light comes on after blinking for 1 minute: Malfunction in the tire pressure warning system. (→P. 575)	Have the system checked by your Toyota dealer.

5-2. Steps to take in an emergency

Warning light	Warning light/Details	Correction procedure
	Low fuel level warning light Indicates that remaining fuel is about 4.0 gal. (15.0 L, 3.3 Imp. gal.) or less	Refuel the vehicle.
 (if equipped)	Master warning light A buzzer sounds and the warning light comes on and flashes to indicate that the master warning system has detected a malfunction.	Take appropriate action in accordance with the message displayed on the multi-information display.
	Low windshield washer fluid level warning light Indicates that the windshield washer fluid level is too low.	Add washer fluid.
 (AWD models)	Active Torque Control 4WD system warning light	
	When the light blinks: The system has been overloaded and front-wheel drive has been automatically engaged.	Drop your speed or stop the vehicle until the light stops blinking. (Do not stop the engine.)
	When the light comes on: Malfunction in the Active Torque Control 4WD system.	Have the system checked by your Toyota dealer.

Warning light	Warning light/Details	Correction procedure
	Maintenance required reminder light Indicates that maintenance is required according to the driven distance on the maintenance schedule. *3	
	Illuminates for about 3 seconds and then flashes for about 15 seconds approximately 4500 miles (7200 km) after the reminder light has been reset.	If necessary, perform maintenance.
	Comes on and remains on if the distance driven exceeds 5000 miles (8000 km) after the maintenance data has been reset. (The indicator will not work properly unless the reminder light has been reset.)	Perform the necessary maintenance. Please reset the reminder light is performed. (→P. 477)

*1: Open door warning buzzer:

The open door warning buzzer sounds to alert one or more of the doors is not fully closed (with the vehicle having reached a speed of 3 mph [5 km/h]).

*2: Driver's and front passenger's seat belt reminder buzzer:



The driver's and front passenger's seat belts reminder sounds to alert the driver and front passenger that his/her seat belt is not fastened. The buzzer sounds intermittently for 10 seconds after the vehicle had reached a speed of at least 12 mph (20 km/h). Then, if the seat belt is still unfastened, the buzzer will sound in a different tone for 20 more seconds.

*3: Refer to the separate "Scheduled Maintenance Guide" or "Owner's Manual Supplement" for the maintenance interval applicable to your vehicle.



5-2. Steps to take in an emergency

Follow the correction procedures. (smart key system)

After taking the specified steps to correct the suspected problem, check that the warning light turns off.

Interior buzzer	Exterior buzzer	Warning light	Warning light/Details	Correction procedure
Once	—	 (Comes on for 8 seconds.)	Smart key system warning light Indicates that the electronic key is not present when attempting to start the engine.	Confirm the location of the electronic key*.
Once	3 times		Smart key system warning light Indicates that a door other than the driver's door has been opened or closed with the "ENGINE START STOP" switch in any mode other than off and the electronic key outside of the detection area.	Confirm the location of the electronic key.

5-2. Steps to take in an emergency

Interior buzzer	Exterior buzzer	Warning light	Warning light/Details	Correction procedure
Once	3 times		Smart key system warning light Indicates that the driver's door has been opened or closed with the shift lever in "P", the "ENGINE START STOP" switch in any mode other than off and the electronic key outside of the detection area.	Turn the "ENGINE START STOP" switch off or confirm the location of the electronic key.
Continuous	Continuous		Smart key system warning light Indicates that the driver's door has been opened or closed with the shift lever not in "P", the "ENGINE START STOP" switch in any mode other than off and the electronic key outside of the detection area.	<ul style="list-style-type: none"> • Shift the shift lever to "P". • Confirm the location of the electronic key.

*: If the engine does not start when the electronic key is inside the vehicle, the electronic key battery may be depleted or there may be difficulties receiving the signal from the key. (→P. 596)

■ **If the malfunction indicator lamp comes on while driving**

First check the following:

- Is the fuel empty?
If it is, fill the fuel tank immediately.
- Is the fuel tank cap loose?
If it is, tighten it securely.

The malfunction indicator lamp will go off after taking several driving trips. If the malfunction indicator lamp does not go off even after several trips, contact your Toyota dealer as soon as possible.

■ **Key reminder buzzer (vehicles without smart key system)**

The buzzer indicates that the key has not been removed with the engine off and the driver's door opened.

■ **Open moon roof warning buzzer**

The buzzer indicates that the moon roof is not fully closed with the engine off and the driver's door opened.

■ **Front passenger detection sensor and passenger seat belt reminder**

- If luggage is placed on the front passenger seat, the front passenger detection sensor may cause the warning light to flash, even if a passenger is not sitting in the seat.
- If a cushion is placed on the seat, the sensor may not detect a passenger, and the warning light may not operate properly.

■ **Electric power steering system warning light**

When the battery charge becomes insufficient or the voltage temporarily drops, the electric power steering system warning light may come on.

■ **SRS warning light**

This warning light system monitors the airbag sensor assembly, front airbag sensors, side and curtain shield airbag sensors, curtain shield airbag sensors, driver's seat position sensor, driver's seat belt buckle switch, front passenger occupant classification system (ECU and sensors), "AIR BAG ON" indicator light, "AIR BAG OFF" indicator light, front passenger's seat belt buckle switch, seat belt pretensioner assemblies, airbags, interconnecting wiring and power sources. (→P. 121)

■ **The tire pressure warning light may come on due to natural causes**

The tire pressure warning light may come on due to natural causes such as natural air leaks or tire inflation pressure changes caused by temperature. In this case, adjusting the tire inflation pressure will turn off the warning light (after a few minutes).

■ **When a tire is replaced with a spare tire**

The compact spare tire is not equipped with the tire pressure warning valve and transmitter. If a tire goes flat, the tire pressure warning light will not turn off even though the flat tire is replaced with the spare tire. Replace the spare tire with the repaired tire and adjust the proper tire inflation pressure. The tire pressure warning light will turn off after a few minutes.

5-2. Steps to take in an emergency

■ If the tire pressure warning system is inoperative

The tire pressure warning system will be disabled in the following conditions:

(When the condition becomes normal, the system will work properly.)

- If tires not equipped with tire pressure warning valves and transmitters are used.
- If the ID code on the tire pressure warning valves and transmitters is not registered in the tire pressure warning computer.
- If the tire inflation pressure is 73 psi (500 kPa, 5.1 kgf/cm² or bar) or higher.

The tire pressure warning system may be disabled in the following conditions:

(When the condition becomes normal, the system will work properly.)

- If electronic devices or facilities using similar radio wave frequencies are nearby.
- If a radio set at similar frequencies is in use in the vehicle.
- If a window tint that affects the radio wave signals is installed.
- If there is a lot of snow or ice on the vehicle, in particular around the wheels or wheel housings.
- If non-genuine Toyota wheels are used. (Even if you use Toyota wheels, the tire pressure warning system may not work properly with some types of tires.)
- If tire chains are used.

■ **If the tire pressure warning light frequently comes on after blinking for 1 minute**

▶ Vehicles with smart key system

If the tire pressure warning light frequently comes on after blinking for 1 minute when the “ENGINE START STOP” switch is turned to IGNITION ON mode, have it checked by your Toyota dealer.

▶ Vehicles without smart key system

If the tire pressure warning light comes on after blinking 1 minute frequently when the engine switch is turned to the “ON” position, have it checked by your Toyota dealer.

 CAUTION

■ **When the electric power steering system warning light comes on**

The steering wheel may become extremely heavy. If the steering wheel becomes heavier than usual when operating, hold firmly and operate using more force than usual.

■ **If the tire pressure warning light comes on**

Be sure to observe the following precautions. Failure to do so could cause loss of vehicle control and result in death or serious injury.

- Stop your vehicle in a safe place as soon as possible. Adjust the tire inflation pressure immediately.
- If the tire pressure warning light comes on even after tire inflation pressure adjustment, it is probable that you have a flat tire. Check the tires. If the tire is flat, change to the spare tire and have the flat tire repaired by the nearest Toyota dealer.
- Avoid abrupt maneuvering and braking. If the vehicle tires deteriorate, you could lose control of the steering wheel or the brakes.

 CAUTION

■ **If a blowout or sudden air loss should occur**

The tire pressure warning system may not activate immediately.

■ **Maintenance of the tires**

Each tire, including the spare (if provided), should be checked monthly when cold and inflated to the inflation pressure recommended by the vehicle manufacturer on the vehicle placard or tire inflation pressure label (tire and load information label). (If your vehicle has tires of a different size than the size indicated on the vehicle placard or tire inflation pressure label [tire and load information label], you should determine the proper tire inflation pressure for those tires.)

As an added safety feature, your vehicle has been equipped with a tire pressure monitoring system (TPMS-tire pressure warning system) that illuminates a low tire pressure telltale (tire pressure warning light) when one or more of your tires is significantly under-inflated. Accordingly, when the low tire pressure telltale (tire pressure warning light) illuminates, you should stop and check your tires as soon as possible, and inflate them to the proper pressure. Driving on a significantly under-inflated tire causes the tire to overheat and can lead to tire failure. Under-inflation also reduces fuel efficiency and tire tread life, and may affect the vehicle's handling and stopping ability.

Please note that the TPMS (tire pressure warning system) is not a substitute for proper tire maintenance, and it is the driver's responsibility to maintain correct tire pressure, even if under-inflation has not reached the level to trigger illumination of the TPMS low tire pressure telltale (tire pressure warning light).

 CAUTION

Your vehicle has also been equipped with a TPMS (tire pressure warning system) malfunction indicator to indicate when the system is not operating properly. The TPMS (tire pressure warning system) malfunction indicator is combined with the low tire pressure telltale (tire pressure warning light). When the system detects a malfunction, the telltale will flash for approximately one minute and then remain continuously illuminated. This sequence will continue upon subsequent vehicle start-ups as long as the malfunction exists. When the malfunction indicator is illuminated, the system may not be able to detect or signal low tire pressure as intended.

TPMS (tire pressure warning system) malfunctions may occur for a variety of reasons, including the installation of replacement or alternate tires or wheels on the vehicle that prevent the TPMS (tire pressure warning system) from functioning properly. Always check the TPMS (tire pressure warning system) malfunction telltale after replacing one or more tires or wheels on your vehicle to ensure that the replacement or alternate tires and wheels allow the TPMS (tire pressure warning system) to continue to function properly.

 NOTICE

■ **To ensure the tire pressure warning system operates properly**

Do not install tires with different specifications or makers, as the tire pressure warning system may not operate properly.

5-2. Steps to take in an emergency If a warning message is displayed*

The multi-information display shows warnings of system malfunctions or incorrectly performed operations. When a message is shown, perform corrections as indicated in the message.

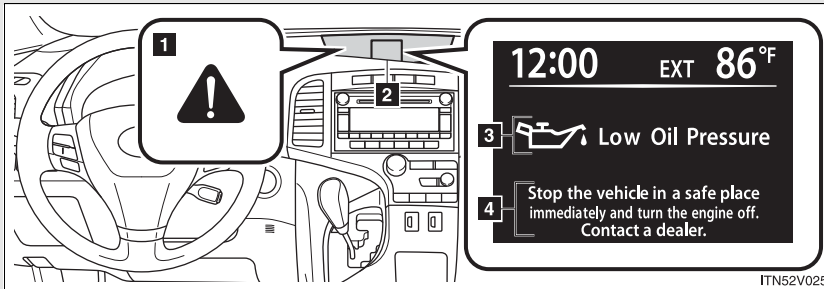

1 Master warning light

The master warning light comes on or flashes when a message is being shown on the multi-information display.

2 Multi-information display

3 Warning message

4 Correction procedure

Warning buzzer

A buzzer may sound when a warning message is shown on the multi-information display.

If the warning message is shown again after its correction procedure has been performed

Contact your Toyota dealer as soon as possible.

*: If equipped

5-2. Steps to take in an emergency If you have a flat tire

Your vehicle is equipped with a spare tire. The flat tire can be replaced with the spare tire.

■ Before jacking up the vehicle

- Stop the vehicle on a hard, flat surface.
- Set the parking brake.
- Shift the shift lever to “P”.
- Stop the engine.
- Turn on the emergency flashers.

■ Location of the spare tire, jack and tools

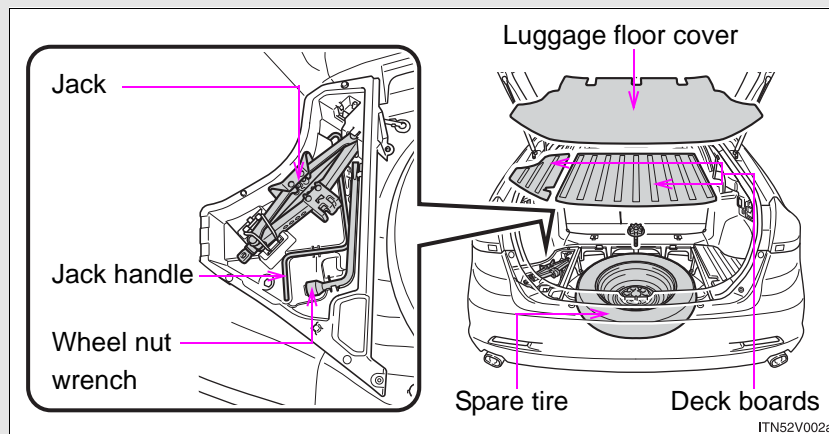

5-2. Steps to take in an emergency

■ Compact spare tire

The compact spare tire saves space in your luggage compartment, and its lighter weight helps to enhance fuel economy and permits easier installation in case of a flat tire.

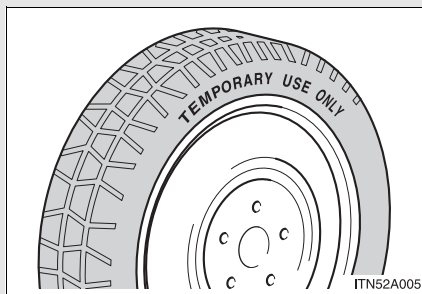

The compact spare tire is designed for temporary emergency use only.

Taking out the jack

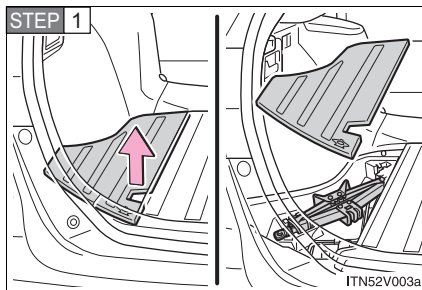

Remove the left side deck board.

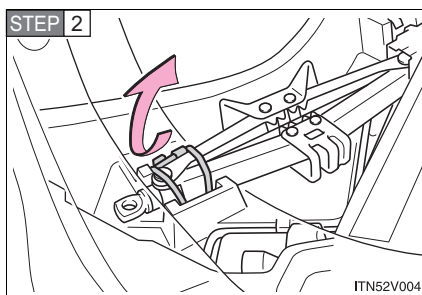

Unlock the tightening strap.

After storing the jack, make sure it is securely held by the tightening strap.

Taking out the spare tire

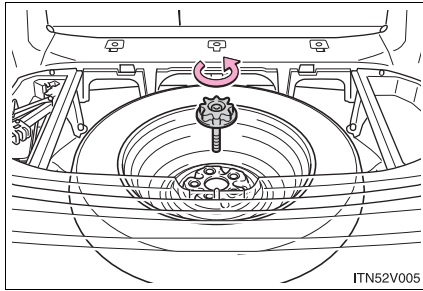

Loosen the center fastener that secures the spare tire.

Replacing a flat tire

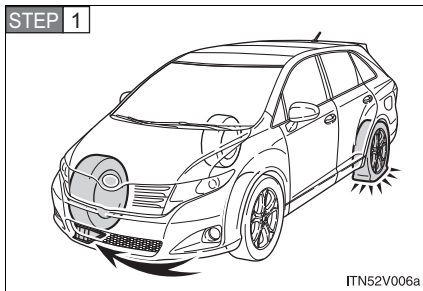

Check the tires.

Flat tire		Wheel chock positions
Front	Left-hand side	Behind the rear right-hand side tire
	Right-hand side	Behind the rear left-hand side tire
Rear	Left-hand side	In front of the front right-hand side tire
	Right-hand side	In front of the front left-hand side tire

5-2. Steps to take in an emergency

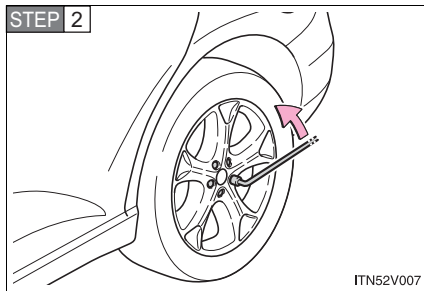

Slightly loosen the wheel nuts (one turn).

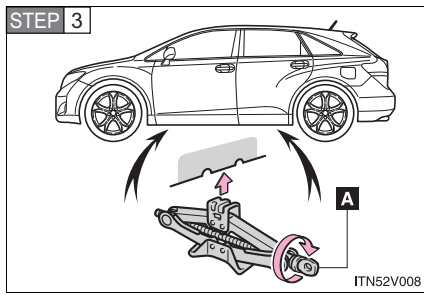

Turn the tire jack portion "A" by hand until the notch of the jack is in contact with the jack point.

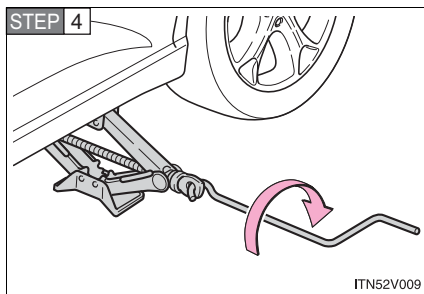

Raise the vehicle until the tire is slightly raised off the ground.

5-2. Steps to take in an emergency

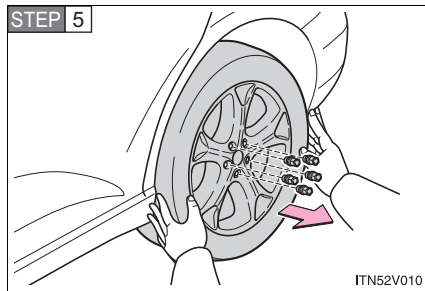

Remove all the wheel nuts and the tire.

When resting the tire on the ground, place the tire so that the wheel design faces up to avoid scratching the wheel surface.

Installing the spare tire

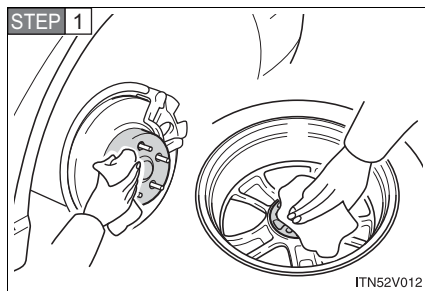

Remove any dirt or foreign matter from the wheel contact surface.

If foreign matter is on the wheel contact surface, the wheel nuts may loosen while the vehicle is in motion, and the tire may come off the vehicle.

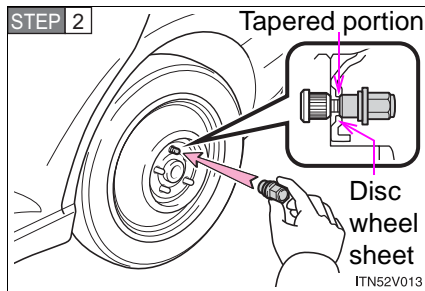

Install the spare tire and loosely tighten each nut by hand to approximately the same amount.

Tighten the wheel nuts until the tapered portion comes into loose contact with the disc wheel sheet.

5

When trouble arises

5-2. Steps to take in an emergency

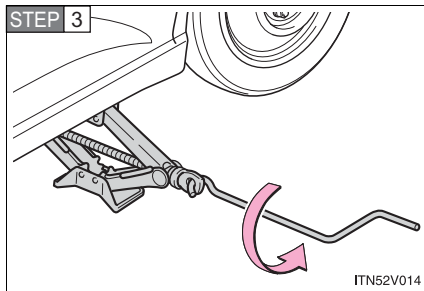

Lower the vehicle.

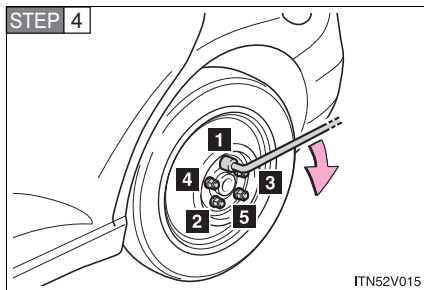

Firmly tighten each nut two or three times in the order shown in the illustration.

Tightening torque:
76 ft•lbf (103 N•m, 10.5 kgf•m)

STEP 5 Stow the flat tire, tire jack and all tools.

■ **The compact spare tire**

- The compact spare tire is identified by the label “TEMPORARY USE ONLY” on the tire sidewall.
Use the compact spare tire temporarily only in an emergency.
- Make sure to check the tire inflation pressure of the compact spare tire. (→P. 623)

■ **When using the compact spare tire**

As the spare tire is not equipped with the tire pressure warning valve and transmitter, low inflation pressure of the spare tire will not be warned. Also, if you replace the compact spare tire after the tire pressure warning light comes on, the light remains on.

■ **If you have a flat front tire on a road covered with snow or ice**

Install the compact spare tire on the rear of the vehicle. Perform the following steps and fit tire chains to the front tires.

STEP 1 Replace a rear tire with the compact spare tire.

STEP 2 Replace the flat front tire with the tire removed from the rear of the vehicle.

STEP 3 Fit tire chains to the front tires.

 CAUTION

■ **Using the tire jack**

Improper use of the tire jack may lead to death or serious injuries due to the vehicle suddenly falling off the jack.

- Do not use the tire jack for any purpose other than replacing tires or installing and removing tire chains.
- Only use the tire jack that comes with this vehicle for replacing a flat tire.
Do not use it on other vehicles, and do not use other tire jacks for replacing tires on this vehicle.
- Always check that the tire jack is securely set to the jack point.
- Do not raise the vehicle while someone is in it.
- When raising the vehicle, do not put an object on or under the jack.
- Do not raise the vehicle to a height greater than that required to replace the tire.
- Use a jack stand if it is necessary to get under the vehicle.
- Do not put any part of your body under the vehicle supported by a jack.
- Do not start or run the engine while your vehicle is supported by the jack.

Take particular care when lowering the vehicle to ensure that no one working on or near the vehicle may be injured.

 CAUTION**■ Replacing a flat tire**

- Do not touch the disc wheels or the area around the brakes immediately after the vehicle has been driven. After the vehicle has been driven the disc wheels and the area around the brakes will be extremely hot. Touching these areas with hands, feet or other body parts while changing a tire, etc. may result in burns.
- Failure to follow these precautions could cause the wheel nuts to loosen and the tire to fall off, resulting in death or serious injury.
 - Have the wheel nuts tightened with a torque wrench to 76 ft•lbf (103 N•m, 10.5 kgf•m) as soon as possible after changing wheels. Failure to follow these precautions could cause the nuts to loosen and the wheels may fall off, which could lead to an accident causing death or serious injury.
 - Do not attach a heavily damaged wheel ornament, as it may fly off the wheel while the vehicle is moving.
 - When installing the wheel nuts, be sure to install them with the tapered ends facing inward. (→P. 519)

■ Replacing a flat tire for vehicles with power back door

In cases such as when replacing tires, make sure to turn off the power back door main switch (→P. 59). Failure to do so may cause the back door to operate unintentionally if the power back door switch is accidentally touched, resulting in hands and fingers being caught and injured.

 CAUTION

■ **When using the compact spare tire**

- Remember that your compact spare tire is specifically designed for use with your vehicle. Do not use your compact spare tire on another vehicle.
- Do not use more than one compact spare tire simultaneously.
- Replace the compact spare tire with a standard tire as soon as possible.
- Avoid sudden acceleration, abrupt steering, sudden braking and shifting operations that cause sudden engine braking.

■ **Speed limit when using the compact spare tire**

Do not drive at speeds in excess of 50 mph (80 km/h) when a compact spare tire is installed on the vehicle.

The compact spare tire is not designed for driving at high speeds. Failing to observe this precaution may lead to an accident causing death or serious injury.

■ **When the compact spare tire is attached**

The vehicle speed may not be correctly detected, and the following systems may not operate correctly:

- ABS & Brake assist
- VSC
- TRAC
- Cruise control system
- Intuitive parking assist
- Rear view monitor system (if equipped)
- Entune Premium Audio with Navigation (if equipped)

Also, not only can the AWD system not be utilized fully, it may actually negatively effect the drive-train components (AWD models only).

 NOTICE**■ Do not drive the vehicle with a flat tire**

Do not continue driving with a flat tire.
Driving even a short distance with a flat tire can damage the tire and the wheel beyond repair.

■ Be careful when driving over bumps with the compact spare tire installed on the vehicle

The vehicle becomes lower when driving with the compact spare tire compared to when driving with standard tires. Be careful when driving over uneven road surfaces.

■ Driving with tire chains and the compact spare tire

Do not fit tire chains to the compact spare tire.
Tire chains may damage the vehicle body and adversely affect driving performance.

■ When replacing the tires

- When removing or fitting the wheels, tires or the tire pressure warning valve and transmitter, contact your Toyota dealer as the tire pressure warning valve and transmitter may be damaged if not handled correctly.
- Replace the grommets for the tire pressure warning valves and transmitters as well.

■ To avoid damage to the tire pressure warning valves and transmitters

When a tire is repaired with liquid sealants, the tire pressure warning valve and transmitter may not operate properly. If a liquid sealant is used, contact your Toyota dealer or other qualified service shop as soon as possible. Make sure to replace the tire pressure warning valve and transmitter when replacing the tire (→P. 507)

5-2. Steps to take in an emergency If the engine will not start

If the engine still does not start after following the correct starting procedure (→P. 173, 177) or releasing the steering lock (→P. 175, 178), confirm the following points.

■ The engine will not start even if you are carrying the correct key.

One of the following may be the cause of the problem.

- There may not be sufficient fuel in the vehicle's tank.
Refuel the vehicle.
- The engine may be flooded.
Try to restart the engine once more following correct starting procedures. (→P. 173, 177)
- There may be a malfunction in the engine immobilizer system.
(→P. 109)

■ The starter motor turn over slowly, the interior lights and headlights are dim, or the horn does not sound or sounds at a low volume.

One of the following may be the cause of the problem.

- The battery may be discharged. (→P. 598)
- The battery terminal connections may be loose or corroded.

■ **The starter motor does not turn over (vehicles with smart key system).**

The engine starting system may be malfunctioning due to an electrical problem such as an open circuit or a blown fuse. However, an interim measure is available to start the engine.
(→P. 592)

■ **The starter motor does not turn over, the interior lights and headlights do not turn on, or the horn does not sound.**

One of the following may be the cause of the problem.

- One or both of the battery terminals may be disconnected.
- The battery may be discharged. (→P. 598)
- There may be a malfunction in the steering lock system (vehicles with smart key system).

Contact your Toyota dealer if the problem cannot be repaired, or if repair procedures are unknown.

Emergency start function (vehicles with smart key system)

When the engine does not start, the following steps can be used as an interim measure to start the engine if the “ENGINE START STOP” switch is functioning normally.

STEP 1 Set the parking brake.

STEP 2 Shift the shift lever to “P”.

STEP 3 Set the “ENGINE START STOP” switch to ACCESSORY mode.

STEP 4 Press and hold the “ENGINE START STOP” switch for about 15 seconds while depressing the brake pedal firmly.

Even if the engine can be started using the above steps, the system may be malfunctioning. Have the vehicle checked by your Toyota dealer.

5-2. Steps to take in an emergency

If the shift lever cannot be shifted from "P"

If the shift lever cannot be shifted with your foot on the brake, there may be a problem with the shift lock system (a system to prevent accidental operation of the shift lever). Have the vehicle inspected by your Toyota dealer immediately.

The following steps may be used as an emergency measure to ensure that the shift lever can be shifted.

STEP 1 Set the parking brake.

STEP 2 Vehicles with smart key system: Turn the "ENGINE START STOP" switch to ACCESSORY mode.

Vehicles without smart key system: Turn the engine switch to the "ACC" position.

STEP 3 Depress the brake pedal.

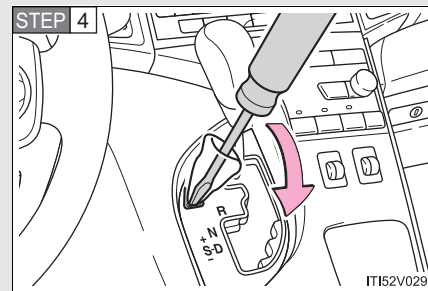

Pry the cover up with a flat-head screwdriver or equivalent.

To prevent damage to the cover, cover the tip of the screwdriver with a rag.

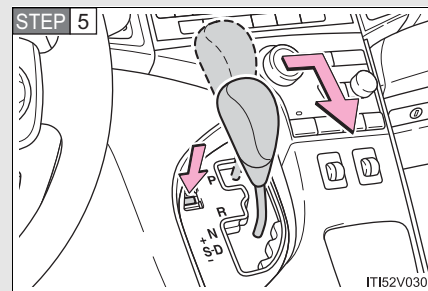

Press the shift lock override button.

The shift lever can be shifted while the button is pressed.

5-2. Steps to take in an emergency
If you lose your keys

New genuine keys can be made by your Toyota dealer. Bring the other key and the key number stamped on the key number plate.

5-2. Steps to take in an emergency

If the electronic key does not operate properly (vehicles with smart key system)

If communication between the electronic key and vehicle is interrupted (→P. 30) or the electronic key cannot be used because the battery is depleted, the smart key system and wireless remote control cannot be used. In such cases, the doors can be opened or the engine can be started by following the procedure below.

Locking and unlocking the doors and key linked functions

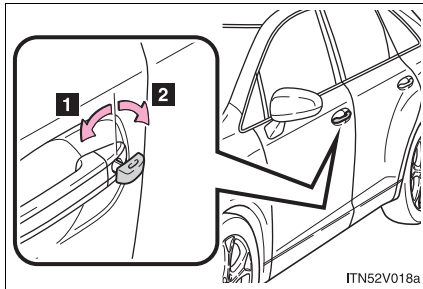

Using the mechanical key (→P. 29) in order to perform the following operations.

- 1** Locks all doors
- 2** Unlocks all doors

Turning the key rearward unlocks the driver's door. Turning the key once again within 3 seconds unlocks the other doors.

Starting the engine

STEP 1 Shift the shift lever to “P” and apply the brakes.

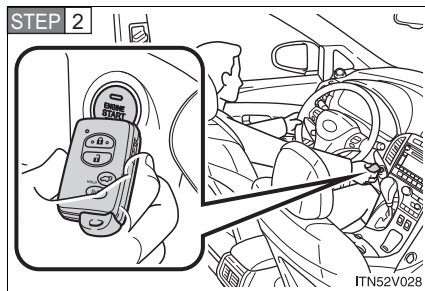

Touch the Toyota emblem side of the electronic key to the “ENGINE START STOP” switch.

An alarm will sound to indicate that the start function cannot detect the electronic key that is touched to the “ENGINE START STOP” switch if any of the doors is opened and closed while the key is touched to the switch.

STEP 3 Press the “ENGINE START STOP” switch within 10 seconds after the buzzer sounds, keeping the brake pedal depressed. In the event that the “ENGINE START STOP” switch cannot be operated, contact your Toyota dealer.

■ **Stopping the engine**

Shift the shift lever to “P” and press the “ENGINE START STOP” switch as you normally do when stopping the engine.

■ **Replacing the key battery**

As this above procedure is a temporary measure, it is recommended that the electronic key battery be replaced immediately when the battery depletes. (→P. 523)

■ **Alarm**

Using the mechanical key to lock the doors will not set the alarm system. If a door is unlocked using the mechanical key when the alarm system is set, the alarm may be triggered. (→P. 112)

■ **Changing “ENGINE START STOP” switch mode**

Release the brake pedal and press the “ENGINE START STOP” switch in **STEP 3** above.

The engine does not start and modes will be changed each time the switch is pressed. (→P. 174)

5-2. Steps to take in an emergency If the battery is discharged

The following procedures may be used to start the engine if the battery is discharged.

You can call your Toyota dealer or qualified repair shop.

If you have a set of jumper (or booster) cables and a second vehicle with a 12 volt battery, you can jump start your Toyota following the steps below.

STEP 1 Connecting the jumper cables.

► 2GR-FE engine

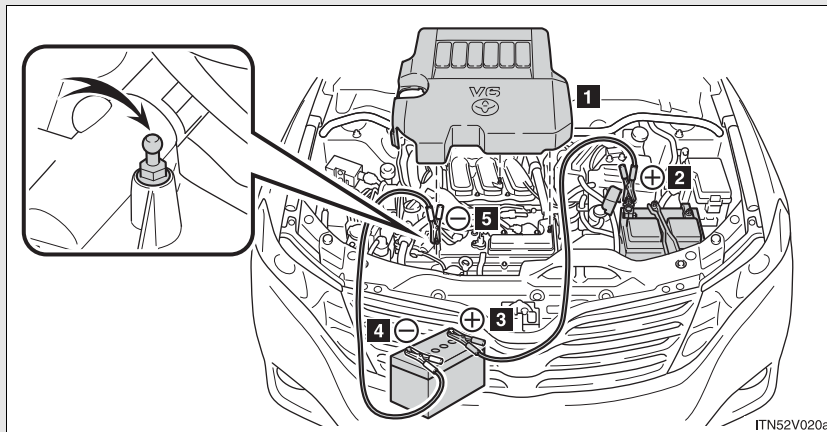

- 1** Remove the engine cover.
- 2** Positive (+) battery terminal on your vehicle
- 3** Positive (+) battery terminal on the second vehicle
- 4** Negative (-) battery terminal on the second vehicle
- 5** Connect the jumper cable to ground on your vehicles as shown in the illustration.

► 1AR-FE engine

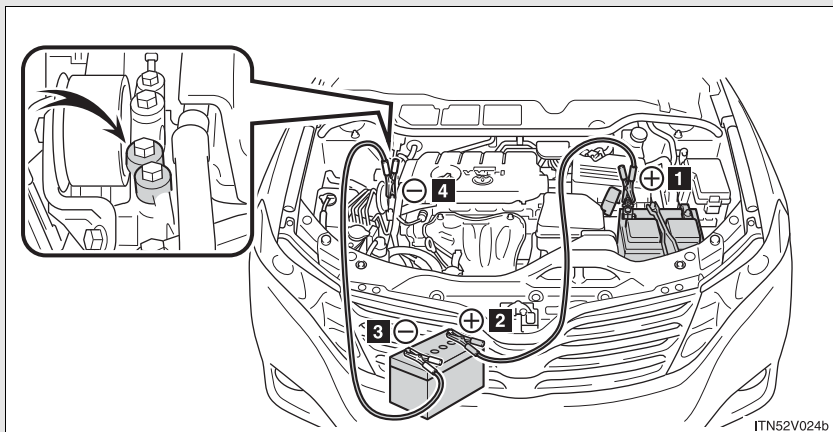

- 1** Positive (+) battery terminal on your vehicle
- 2** Positive (+) battery terminal on the second vehicle
- 3** Negative (-) battery terminal on the second vehicle
- 4** Connect the jumper cable to ground on your vehicles as shown in the illustration.

5-2. Steps to take in an emergency

STEP 2 Start the engine of the second vehicle. Increase the engine speed slightly and maintain at that level for approximately 5 minutes to recharge the battery of your vehicle.

STEP 3 Vehicles with smart key system: Open and close any of the doors with the “ENGINE START STOP” switch off.

STEP 4 Maintain the engine speed of the second vehicle and turn the “ENGINE START STOP” switch to IGNITION ON mode (vehicles with smart key system) or turn the engine switch to the “ON” position (vehicles without smart key system), then start your vehicle’s engine.

STEP 5 Once the vehicle’s engine has started, remove the jumper cables in the exact reverse order in which they were connected.

Once the engine starts, have the vehicle checked at your Toyota dealer as soon as possible.

■ Starting the engine when the battery is discharged

The engine cannot be started by push-starting.

■ Avoiding a discharged battery

- Turn off the headlights and the audio system while the engine is turned off.
- Turn off any unnecessary electrical components when the vehicle is running at a low speed for an extended period, such as in heavy traffic, etc.

■ When the battery is removed or discharged

- The power back door must be initialized. (→P. 60)
- Make sure that the key is not inside the vehicle when recharging or replacing the battery. The key may be locked in the vehicle if the alarm is activated. (→P. 114)

■ **Charging the battery**

The electricity stored in the battery will discharge gradually even when the vehicle is not in use, due to natural discharge and the draining effects of certain electrical appliances. If the vehicle is left for a long time, the battery may discharge, and the engine may be unable to start. (The battery recharges automatically during driving.)

 **CAUTION**

■ **Avoiding battery fires or explosions**

Observe the following precautions to prevent accidentally igniting the flammable gas that may be emitted from the battery.

- Make sure the jumper cable is connected to the correct terminal and that it is not unintentionally in contact with any part other than the intended terminal.
- Do not allow the jumper cables to come into contact with the “+” and “-” terminals.
- Do not allow open flame or use matches, cigarette lighters or smoke near the battery.

5-2. Steps to take in an emergency

CAUTION

■ Battery precautions

The battery contains poisonous and corrosive acidic electrolyte, while related parts contain lead and lead compounds. Observe the following precautions when handling the battery:

- When working with the battery, always wear safety glasses and take care not to allow any battery fluids (acid) to come into contact with skin, clothing or the vehicle body.
- Do not lean over the battery.
- If the battery fluid comes into contact with the skin or eyes, immediately wash the affected area with water and seek medical attention. Place a wet sponge or cloth over the affected area until medical attention can be received.
- Always wash your hands after handling the battery support, terminals, and other battery-related parts.
- Do not allow children near the battery.

NOTICE

■ When handling jumper cables

Be careful that the jumper cables do not become tangled in the cooling fan or any of the belts when connecting or disconnecting them.

5-2. Steps to take in an emergency If your vehicle overheats

The following may indicate that your vehicle is overheating.

- The engine coolant temperature gauge (→P. 188) reaches the maximum, or a loss of engine power is experienced. (For example, the vehicle speed does not increase.)
- Steam comes out from under the hood.

Correction procedures

STEP 1 Stop the vehicle in a safe place and turn off the air conditioning system, and then stop the engine.

STEP 2 If you see steam:

Carefully lift the hood after the steam subsides.

If you do not see steam:

Carefully lift the hood.

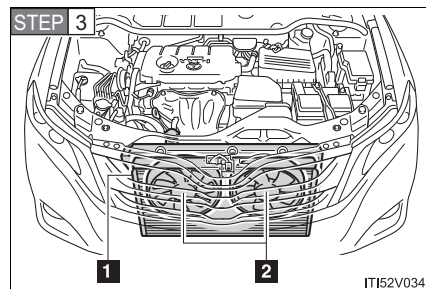

After the engine has cooled down sufficiently, inspect the hoses and radiator core (radiator) for any leaks.

- 1** Radiator
- 2** Cooling fans

If a large amount of coolant leaks, immediately contact your Toyota dealer.

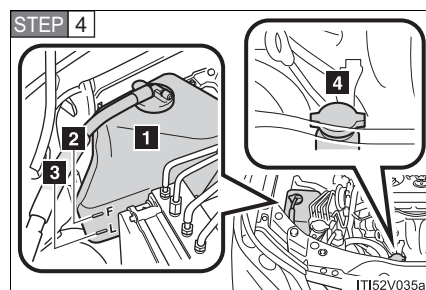

The coolant level is satisfactory if it is between the “F” and “L” lines on the reservoir.

- 1** Reservoir
- 2** “F” line
- 3** “L” line
- 4** Radiator cap

5-2. Steps to take in an emergency

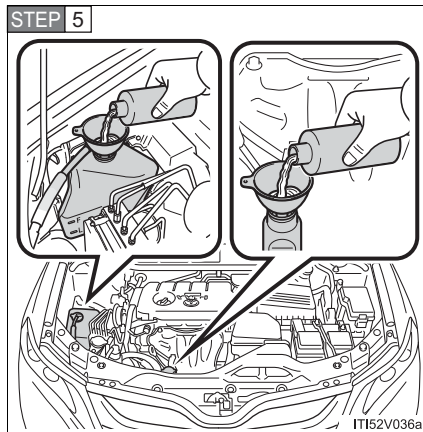

Add coolant if necessary.

Water can be used in an emergency if coolant is unavailable.

STEP 6 Start the engine and turn the air conditioning system on to check that the radiator cooling fans operate and to check for coolant leaks from the radiator or hoses.

The fans operate when the air conditioning system is turned on immediately after a cold start. Confirm that the fans are operating by checking the fan sound and air flow. If it is difficult to check these, turn the air conditioning system on and off repeatedly.

(The fans may not operate in freezing temperatures.)

STEP 7 If the fans are not operating:

Stop the engine immediately and contact your Toyota dealer.

If the fans are operating:

Have the vehicle inspected at the nearest Toyota dealer.

 CAUTION

■ **To prevent an accident or injury when inspecting under the hood of your vehicle**

- If steam is seen coming from under the hood, do not open the hood until the steam has subsided. The engine compartment may be very hot, causing serious injury such as burns.
- Keep hands and clothing (especially a tie, a scarf or a muffler) away from the fans and belts. Failure to do so may cause the hands or clothing to be caught, resulting in serious injury.
- Do not loosen the radiator cap while the engine and radiator are hot. Serious injury, such as burns, may result from hot coolant and steam released under pressure.

 NOTICE

■ **When adding engine coolant**

Wait until the engine has cooled down before adding engine coolant. When adding coolant, do so slowly. Adding cool coolant to a hot engine too quickly can cause damage to the engine.

■ **To prevent damage to the cooling system**

Observe the following precautions:

- Avoid contaminating the coolant with foreign matter (such as sand or dust etc.).
- Do not use any coolant additive.

5-2. Steps to take in an emergency If the vehicle becomes stuck

Carry out the following procedures if the tires spin or the vehicle becomes stuck in mud, dirt, or snow.

- STEP 1** Stop the engine. Set the parking brake and shift the shift lever in "P".
- STEP 2** Remove the mud, snow or sand from around the front wheels.
- STEP 3** Place wood, stones or some other material to help provide traction under the front wheels.
- STEP 4** Restart the engine.
- STEP 5** Shift the shift lever to "D" or "R" position and release the parking brake. Then, while exercising caution, depress the accelerator pedal.

■ When it is difficult to free the vehicle

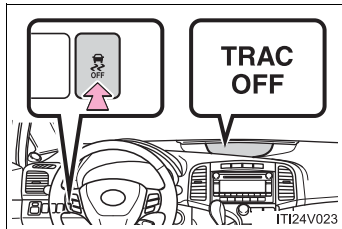

Press  to turn off TRAC.

 CAUTION

■ **When attempting to free a stuck vehicle**

If you choose to rock the vehicle back and forth to free it, make sure the surrounding area is clear, to avoid striking other vehicles, objects or persons. The vehicle may also lunge forward or lunge back suddenly as it becomes free. Use extreme caution.

■ **When shifting the shift lever**

Be careful not to shift the shift lever with the accelerator pedal depressed. This may lead to unexpected rapid acceleration of the vehicle that may cause an accident and result in death or serious injury.

 NOTICE

■ **To avoid damaging the transmission and other components**

- Avoid spinning the front wheels and depressing the accelerator pedal more than necessary.
- If the vehicle remains stuck even after these procedures are performed, the vehicle may require towing to be freed.

5-2. Steps to take in an emergency

If your vehicle has to be stopped in an emergency

Only in an emergency, such as if it becomes impossible to stop the vehicle in the normal way, stop the vehicle using the following procedure:

STEP 1 Steadily step on the brake pedal with both feet and firmly depress it.

Do not pump the brake pedal repeatedly as this will increase the effort required to slow the vehicle.

STEP 2 Shift the shift lever to N.

If the shift lever is shifted to N

STEP 3 After slowing down, stop the vehicle in a safe place by the road.

STEP 4 Stop the engine.

If the shift lever cannot be shifted to N

STEP 3 Keep depressing the brake pedal with both feet to reduce vehicle speed as much as possible.

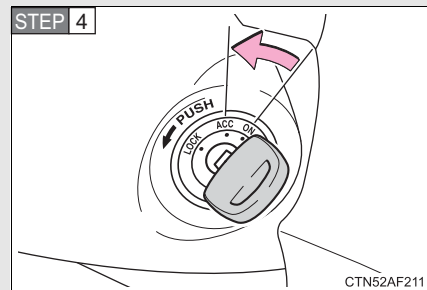

Vehicles without a smart key system: Stop the engine by turning the engine switch to the "ACC" position.

5-2. Steps to take in an emergency

STEP 4

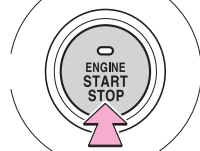

Press and hold for 2 seconds or more,
or press briefly 3 times or more

CTY52AD216

Vehicles with a smart key system: To stop the engine, press and hold the “ENGINE START STOP” switch for 2 consecutive seconds or more, or press it briefly 3 times or more in succession.

STEP 5 Stop the vehicle in a safe place by the road.

CAUTION

■ If the engine has to be turned off while driving

- Power assist for the brake and steering wheel will be lost, making the brake pedal harder to depress and the steering wheel heavier to turn. Decelerate as much as possible before turning off the engine.
- Vehicles without a smart key system: Never attempt to remove the key, as doing so will lock the steering wheel.

5

When trouble arises

5-2. Steps to take in an emergency

610

Vehicle specifications

6

6-1. Specifications

Maintenance data (fuel, oil level, etc.)	612
Fuel information	626
Tire information	630

6-2. Customization

Customizable features	645
--------------------------------	-----

6-3. Initialization

Items to initialize	655
---------------------------	-----

6-1. Specifications

Maintenance data (fuel, oil level, etc.)

Dimensions and weights

Overall length		189.0 in. (4800 mm)
Overall width		75.0 in. (1905 mm)
Overall height* ¹		63.4 in. (1610 mm)
Wheelbase		109.3 in. (2775 mm)
Tread	Front	64.2 in. (1630 mm)
	Rear	64.4 in. (1635 mm) ^{*2} 64.2 in. (1630 mm) ^{*3}
Vehicle capacity weight (Occupants + luggage)		895 lb. (405 kg)
Trailer Weight Rating (TWR)	Without towing package	1000 lb. (450 kg)
	With towing package	3500 lb. (1585 kg) ^{*4} 2500 lb. (1135 kg) ^{*5}

*1: Unladen vehicle

*2: 2WD models

*3: AWD models

*4: 2GR-FE engine

*5: 1AR-FE engine

Vehicle identification

■ Vehicle identification number

The vehicle identification number (VIN) is the legal identifier for your vehicle. This is the primary identification number for your Toyota. It is used in registering the ownership of your vehicle.

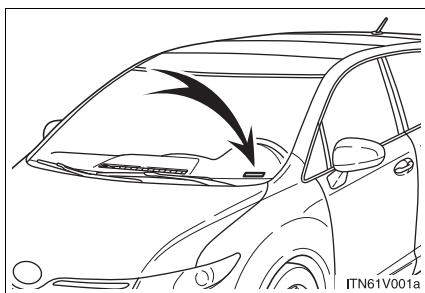

This number is stamped on the top left of the instrument panel.

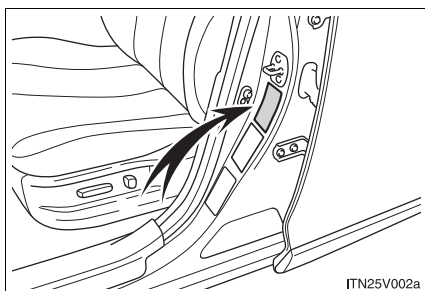

This number is also on the Certification Label.

6-1. Specifications

■ Engine number

▶ 2GR-FE engine

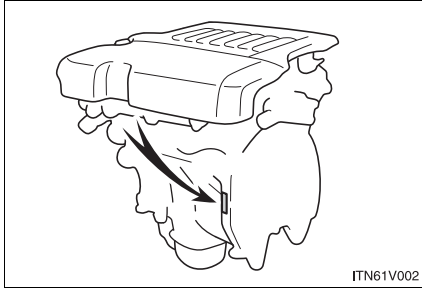

The engine number is stamped on the engine block as shown.

▶ 1AR-FE engine

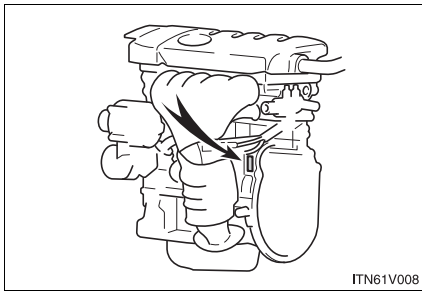

Engine

Model	2GR-FE, 1AR-FE
Type ▶ 2GR-FE engine ▶ 1AR-FE engine	6-cylinder V type, 4-cycle, gasoline 4-cylinder in line, 4-cycle, gasoline
Bore and stroke ▶ 2GR-FE engine ▶ 1AR-FE engine	3.70 × 3.27 in. (94.0 × 83.0 mm) 3.54 × 4.13 in. (90.0 × 105.0 mm)
Displacement ▶ 2GR-FE engine ▶ 1AR-FE engine	210.9 cu.in. (3456 cm ³) 163.1 cu.in. (2672 cm ³)
Valve clearance (engine cold)	Automatic adjustment
Drive belt tension	Automatic adjustment

Fuel

Fuel type	Unleaded gasoline only
Octane rating	87 (Research octane number 91) or higher
Fuel tank capacity (Reference)	17.7 gal. (67 L, 14.7 Imp.gal)

Lubrication system

Oil capacity (Drain and refill — reference*)	
1AR-FE engine	Without filter: 4.2 qt. (4.0 L, 3.5 Imp.qt.) With filter: 4.6 qt. (4.4 L, 3.9 Imp.qt.)
2GR-FE engine	Without filter: 6.0 qt. (5.7 L, 5.0 Imp.qt.) With filter: 6.4 qt. (6.1 L, 5.4 Imp.qt.)

*: The engine oil capacity is a reference quantity to be used when changing the engine oil. Warm up and turn off the engine, wait more than 5 minutes, and check the oil level on the dipstick.

■ **Engine oil selection**

“Toyota Genuine Motor Oil” is used in your Toyota vehicle. Use Toyota approved “Toyota Genuine Motor Oil” or equivalent to satisfy the following grade and viscosity.

Oil grade: ILSAC GF-5 multigrade engine oil

Recommended viscosity: SAE 0W-20

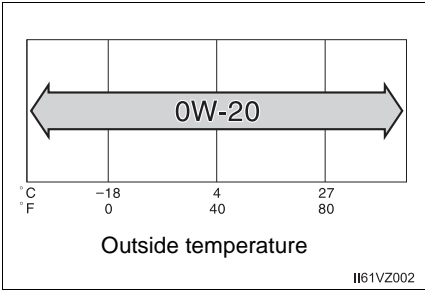

SAE 0W-20 is the best choice for good fuel economy and good starting in cold weather.

If SAE 0W-20 is not available, SAE 5W-20 oil may be used. However, it must be replaced with SAE 0W-20 at the next oil change.

Oil viscosity (0W-20 is explained here as an example):

- The 0W in 0W-20 indicates the characteristic of the oil which allows cold startability. Oils with a lower value before the W allow for easier starting of the engine in cold weather.
- The 20 in 0W-20 indicates the viscosity characteristic of the oil when the oil is at high temperature. An oil with a higher viscosity (one with a higher value) may be better suited if the vehicle is operated at high speeds, or under extreme load conditions.

How to read oil container label:

The International Lubricant Specification Advisory Committee (ILSAC) Certification Mark is added to some oil containers to help you select the oil you should use.



6-1. Specifications

Cooling system

Capacity	
▶ 2GR-FE engine	With towing package: 10.9 qt. (10.3 L, 9.1 Imp.qt.) Without towing package: 10.7 qt. (10.1 L, 8.9 Imp.qt.)
▶ 1AR-FE engine	7.5 qt. (7.1 L, 6.2 Imp.qt.)
Coolant type	Use either of the following: <ul style="list-style-type: none">• “Toyota Super Long Life Coolant”• Similar high-quality ethylene glycol-based non-silicate, non-amine, non-nitrite, and non-borate coolant with long-life hybrid organic acid technology Do not use plain water alone.

Ignition system

Spark plug	
Make	DENSO
▶ 2GR-FE engine	FK20HR11
▶ 1AR-FE engine	SK16HR11
Gap	0.043 in. (1.1 mm)

 **NOTICE****■ Iridium-tipped spark plugs**

Use only iridium-tipped spark plugs. Do not adjust gap when tuning engine.

Electrical system

Battery	
Open voltage at 68°F (20°C):	12.6 — 12.8 V Fully charged 12.2 — 12.4 V Half charged 11.8 — 12.0 V Discharged (Voltage is checked 20 minutes after the engine and all the lights are turned off.)
Charging rates	5 A max.

Rear differential (AWD models)

Oil capacity	0.52 qt. (0.50 L, 0.44 Imp.qt.)
Oil type and viscosity	Toyota Genuine Differential gear oil LT 75W-85 GL-5 or equivalent

6-1. Specifications

Automatic transaxle

Fluid capacity*	
▶ 2GR-FE engine	2WD models: 6.9 qt. (6.5 L, 5.7 Imp.qt.) AWD models: 7.1 qt. (6.7 L, 5.9 Imp.qt.)
▶ 1AR-FE engine	6.9 qt. (6.5 L, 5.7 Imp.qt.)
Fluid type	Toyota Genuine ATF WS

*: The fluid capacity is a reference quantity. If replacement is necessary, contact your Toyota dealer.

NOTICE

■ Automatic transaxle fluid type

Using transaxle fluid other than “Toyota Genuine ATF WS” may cause deterioration in shift quality, locking up of your transaxle accompanied by vibration, and ultimately damage the transaxle of your vehicle.

Transfer (AWD models)

Oil capacity	0.84 qt. (0.80 L, 0.70 Imp.qt.)
Oil type and viscosity	Toyota Genuine Differential gear oil LT 75W-85 GL-5 or equivalent

Brakes

Pedal clearance ^{*1}	1.1 in. (28 mm) Min.
Pedal free play	0.04 — 0.12 in. (1.0 — 3.0 mm)
Brake pad wear limit	0.04 in. (1.0 mm)
Parking brake lining wear limit	0.04 in. (1.0 mm)
Parking brake adjustment ^{*2}	4 — 6 clicks
Fluid type	SAE J1703 or FMVSS No. 116 DOT 3

*1: Minimum pedal clearance when depressed with a force of 112 lbf (500 N, 51 kgf) while the engine is running.

*2: Parking brake pedal travel when depressed with a force of 67.4 lbf (300 N, 30.6 kgf).

Steering

Free play	Less than 1.2 in. (30 mm)
-----------	---------------------------

6-1. Specifications

Tires and wheels

► Type A

Tire size	P245/50R20 102H
Tire inflation pressure (Recommended cold tire inflation pressure)	<p>Driving under normal conditions</p> <p>Front tires: 32 psi (220 kPa, 2.2 kgf/cm² or bar)</p> <p>Rear tires: 32 psi (220 kPa, 2.2 kgf/cm² or bar)</p> <p>Driving at high speeds above 99 mph (160 km/h) (in countries where such speeds are permitted by law)</p> <p>Add 3 psi (20 kPa, 0.2 kgf/cm² or bar) to the front tires and rear tires. Never exceed the maximum cold tire inflation pressure indicated on the tire sidewall.</p>
Wheel size	20 × 7 1/2 J
Wheel nut torque	76 ft•lbf (103 N•m, 10.5 kgf•m)

► Type B

Tire size	P245/55R19 103S
Tire inflation pressure (Recommended cold tire inflation pressure)	Driving under normal conditions Front tires: 32 psi (220 kPa, 2.2 kgf/cm ² or bar) Rear tires: 32 psi (220 kPa, 2.2 kgf/cm ² or bar) Driving at high speeds above 99 mph (160 km/h) (in countries where such speeds are permitted by law) Add 3 psi (20 kPa, 0.2 kgf/cm ² or bar) to the front tires and rear tires. Never exceed the maximum cold tire inflation pressure indicated on the tire sidewall.
Wheel size	19 × 7 1/2 J
Wheel nut torque	76 ft•lbf (103 N•m, 10.5 kgf•m)

► Spare tire

Tire size	T165/90D18 107M
Tire inflation pressure (Recommended cold tire inflation pressure)	60 psi (420 kPa, 4.2 kgf/cm ² or bar)
Wheel size	18 x 4T
Wheel nut torque	76 ft•lbf (103 N•m, 10.5 kgf•m)

6-1. Specifications

Light bulbs

	Light Bulbs	Bulb No.	W	Type
Exterior	Headlights ▶ Vehicles with discharge headlights Low and high beam ▶ Vehicles with halogen headlights Low beam High beam	— — 9005	35 55 60	A B C
	Front turn signal lights (vehicles with discharge headlights)	7444 NA	28	D
	Front turn signal/parking lights (vehicles with halogen headlights)	3457 NAK	30/8	D
	Front side marker lights ▶ Vehicle with discharge headlights ▶ Vehicle with halogen headlights	W5W 168	5 5	E E
	Front fog lights	—	55	B
	Stop/tail and rear side marker lights	7443	21/5	E
	Tail lights	194	3.8	E
	Rear turn signal lights	7440A	21	D
	Back-up lights	921	16	E
	License plate lights	W5W	5	E

	Light Bulbs	Bulb No.	W	Type
Interior	Front interior light	—	5	E
	Front personal lights	—	5	E
	Rear personal/interior lights	—	8	E
	Vanity lights	—	8	E
	Door courtesy lights	—	5	E
	Glove box light	74	1.2	E
	Luggage compartment light	—	5	F

A: D4S discharge bulbs

B: H11 halogen bulbs

C: HB3 halogen bulbs

D: Wedge base bulbs (amber)

E: Wedge base bulbs (clear)

F: Double end bulbs

6-1. Specifications

Fuel information

Your vehicle must use only unleaded gasoline.

Select octane rating 87 (Research Octane Number 91) or higher. Use of unleaded gasoline with an octane rating lower than 87 may result in engine knocking. Persistent knocking can lead to engine damage.

At minimum, the gasoline you use should meet the specifications of ASTM D4814 in the U.S.A..

■ Fuel tank opening for unleaded gasoline

To help prevent incorrect fueling, your Toyota has a fuel tank opening that only accommodates the special nozzle on unleaded fuel pumps.

■ If your engine knocks

- Consult your Toyota dealer.
- You may occasionally notice light knocking for a short time while accelerating or driving uphill. This is normal and there is no need for concern.

■ Gasoline quality

In very few cases, driveability problems may be caused by the brand of gasoline you are using. If driveability problems persist, try changing the brand of gasoline. If this does not correct the problem, consult your Toyota dealer.

■ Gasoline quality standards

- Automotive manufacturers in the US, Europe and Japan have developed a specification for fuel quality called World-Wide Fuel Charter (WWFC) that is expected to be applied worldwide.
- The WWFC consists of four categories that are based on required emission levels. In the US, category 4 has been adopted.
- The WWFC improves air quality by lowering emissions in vehicle fleets, and customer satisfaction through better performance.

■ Toyota recommends the use of gasoline containing detergent additives

- Toyota recommends the use of gasoline that contains detergent additives to avoid build-up of engine deposits.
- All gasoline sold in the US contains minimum detergent additives to clean and/or keep clean intake systems, per EPA's lowest additives concentration program.
- Toyota strongly recommends the use of Top Tier Detergent Gasoline. For more information on Top Tier Detergent Gasoline and a list of marketers, please go to the official website www.toptiergas.com.

■ Toyota recommends the use of cleaner burning gasoline

Cleaner burning gasoline, including reformulated gasoline that contains oxygenates such as ethanol or MTBE (Methyl Tertiary Butyl Ether) is available in many areas.

Toyota recommends the use of cleaner burning gasoline and appropriately blended reformulated gasoline. These types of gasoline provide excellent vehicle performance, reduce vehicle emissions and improve air quality.

■ **Toyota does not recommend blended gasoline**

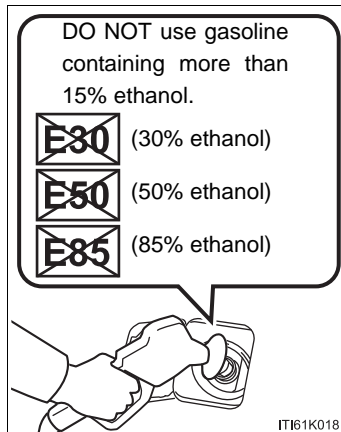

- Use only gasoline containing up to 15% ethanol. DO NOT use any flex-fuel or gasoline that could contain more than 15% ethanol, including from any pump labeled E30, E50, E85 (which are only some examples of fuel containing more than 15% ethanol).

- If you use gasohol in your Toyota, be sure that it has an octane rating no lower than 87.
- Toyota DOES NOT recommend the use of gasoline containing methanol.

■ **Toyota does not recommend gasoline containing MMT**

Some gasoline contains octane enhancing additive called MMT (Methylcyclopentadienyl Manganese Tricarbonyl).

Toyota DOES NOT recommend the use of gasoline that contains MMT. If fuel containing MMT is used, your emission control system may be adversely affected.

The malfunction indicator lamp on the instrument cluster may come on. If this happens, contact your Toyota dealer for service.

 NOTICE**■ Notice on fuel quality**

- Do not use improper fuels. If improper fuels are used the engine will be damaged.
- Do not use leaded gasoline.
Leaded gasoline can cause damage to your vehicle's three-way catalytic converters causing the emission control system to malfunction.
- Do not use gasohol other than that stated here.
Other gasohol may cause fuel system damage or vehicle performance problems.
- Using unleaded gasoline with an octane number or rating lower than that stated here will cause persistent heavy knocking.
At worst, this will lead to engine damage.

■ Fuel-related poor driveability

If after using a different type of fuel, poor driveability is encountered (poor hot starting, vaporization, engine knocking, etc.), discontinue the use of that type of fuel.

■ When refueling with gasohol

Take care not to spill gasohol. It can damage your vehicle's paint.

6-1. Specifications Tire information

Typical tire symbols

► Full-size tire

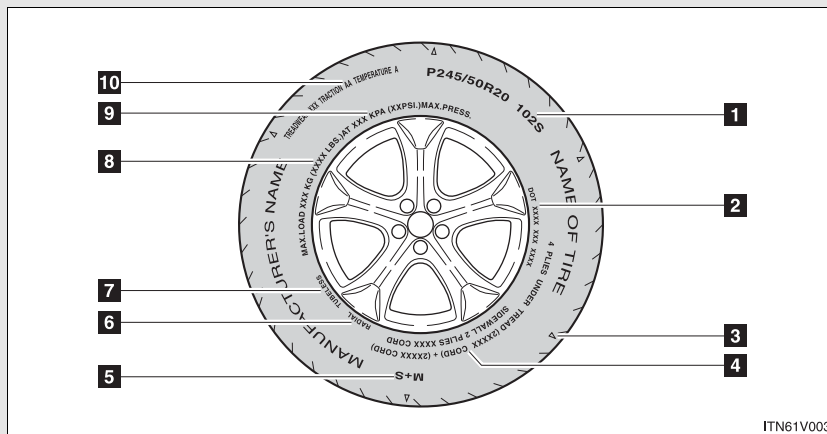

► Compact spare tire

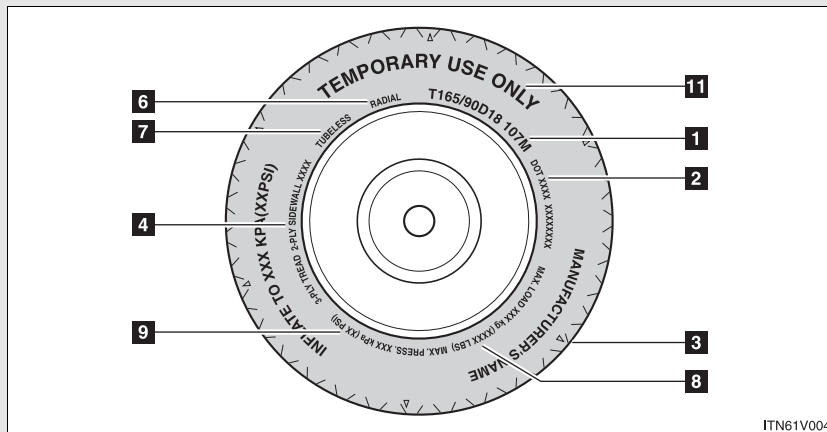

- 1 Tire size (→P. 633)
- 2 DOT and Tire Identification Number (TIN) (→P. 632)

- 3** Location of treadwear indicators (→P. 506)
- 4** Tire ply composition and materials
 Plies are layers of rubber-coated parallel cords. Cords are the strands which form the plies in a tire.
- 5** Summer tires or all season tires (→P. 509)
 An all season tire has "M+S" on the sidewall. A tire not marked "M+S" is a summer tire.
- 6** Radial tires or bias-ply tires
 A radial tire has "RADIAL" on the sidewall. A tire not marked "RADIAL" is a bias-ply tire.
- 7** TUBELESS or TUBE TYPE
 A tubeless tire does not have a tube and air is directly put into the tire. A tube type tire has a tube inside the tire and the tube maintains the air pressure.
- 8** Load limit at maximum cold tire inflation pressure (→P. 637)
- 9** Maximum cold tire inflation pressure (→P. 637)
 This means the pressure to which a tire may be inflated.
- 10** Uniform tire quality grading
 For details, see "Uniform Tire Quality Grading" that follows.
- 11** "TEMPORARY USE ONLY" (→P. 585)
 A compact spare tire is identified by the phrase "TEMPORARY USE ONLY" molded on its sidewall. This tire is designed for temporary emergency use only.

Typical DOT and Tire Identification Number (TIN)

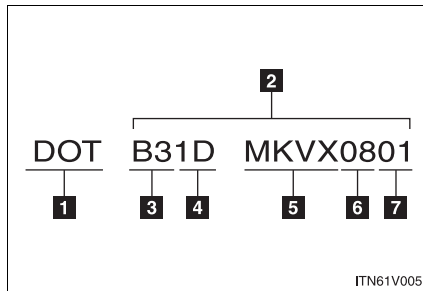

- 1** DOT symbol*
- 2** Tire Identification Number (TIN)
- 3** Tire manufacturer's identification mark
- 4** Tire size code
- 5** Manufacturer's optional tire type code (3 or 4 letters)
- 6** Manufacturing week
- 7** Manufacturing year

*: The DOT symbol certifies that the tire conforms to applicable Federal Motor Vehicle Safety Standards.

Tire size

■ Typical tire size information

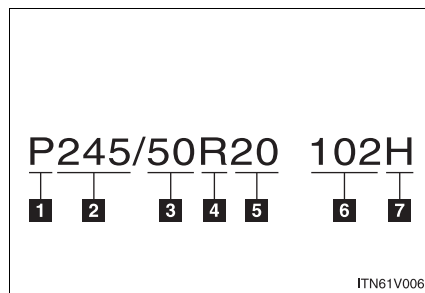

The illustration indicates typical tire size.

- 1** Tire use
(P = Passenger car,
T = Temporary use)
- 2** Section width (millimeters)
- 3** Aspect ratio
(tire height to section width)
- 4** Tire construction code
(R = Radial, D = Diagonal)
- 5** Wheel diameter (inches)
- 6** Load index (2 digits or 3 digits)
- 7** Speed symbol
(alphabet with one letter)

6-1. Specifications

■ Tire dimensions

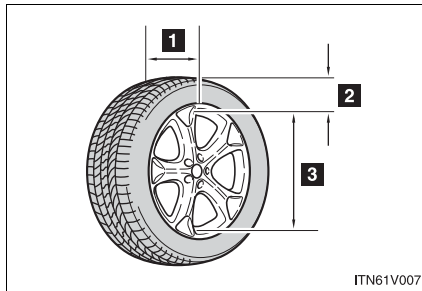

- 1 Section width
- 2 Tire height
- 3 Wheel diameter

Tire section names

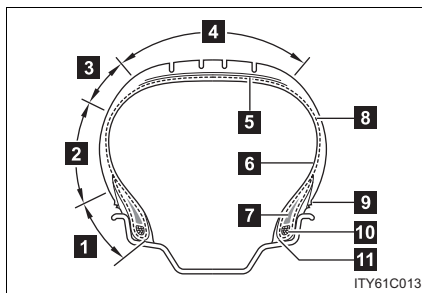

- 1 Bead
- 2 Sidewall
- 3 Shoulder
- 4 Tread
- 5 Belt
- 6 Inner liner
- 7 Reinforcing rubber
- 8 Carcass
- 9 Rim lines
- 10 Bead wires
- 11 Chafer

Uniform Tire Quality Grading

This information has been prepared in accordance with regulations issued by the National Highway Traffic Safety Administration of the U.S. Department of Transportation.

It provides the purchasers and/or prospective purchasers of Toyota vehicles with information on uniform tire quality grading.

Your Toyota dealer will help answer any questions you may have as you read this information.

■ DOT quality grades

All passenger vehicle tires must conform to Federal Safety Requirements in addition to these grades. Quality grades can be found where applicable on the tire sidewall between tread shoulder and maximum section width.

For example: Treadwear 200 Traction AA Temperature A

■ Treadwear

The treadwear grade is a comparative rating based on the wear rate of the tire when tested under controlled conditions on a specified government test course.

For example, a tire graded 150 would wear one and a half (1 - 1/2) times as well on the government course as a tire graded 100.

The relative performance of tires depends upon the actual conditions of their use. Performance may differ significantly from the norm due to variations in driving habits, service practices and differences in road characteristics and climate.

■ **Traction AA, A, B, C**

The traction grades, from highest to lowest, are AA, A, B and C, and they represent the tire's ability to stop on wet pavement as measured under controlled conditions on specified government test surfaces of asphalt and concrete.

A tire marked C may have poor traction performance.

Warning: The traction grade assigned to this tire is based on braking (straight ahead) traction tests and does not include cornering (turning) traction.

■ **Temperature A, B, C**

The temperature grades are A (the highest), B, and C, representing the tire's resistance to the generation of heat and its ability to dissipate heat when tested under controlled conditions on a specified indoor laboratory test wheel.

Sustained high temperature can cause the material of the tire to degenerate and reduce tire life, and excessive temperature can lead to sudden tire failure.

Grade C corresponds to a level of performance which all passenger car tires must meet under the Federal Motor Vehicle Safety Standard No. 109.

Grades B and A represent higher levels of performance on the laboratory test wheel than the minimum required by law.

Warning: The temperature grades of a tire assume that it is properly inflated and not overloaded.

Excessive speed, underinflation, or excessive loading, either separately or in combination, can cause heat buildup and possible tire failure.

Glossary of tire terminology

Tire related term	Meaning
Cold tire inflation pressure	Tire pressure when the vehicle has been parked for three hours or more, or has not been driven more than 1 mile or 1.5 km under that condition
Maximum inflation pressure	The maximum cold inflated pressure to which a tire may be inflated, shown on the sidewall of the tire
Recommended inflation pressure	Cold tire inflation pressure recommended by a manufacturer
Accessory weight	The combined weight (in excess of those standard items which may be replaced) of automatic transmission, power steering, power brakes, power windows, power seats, radio and heater, to the extent that these items are available as factory-installed equipment (whether installed or not)
Curb weight	The weight of a motor vehicle with standard equipment, including the maximum capacity of fuel, oil and coolant, and if so equipped, air conditioning and additional weight optional engine
Maximum loaded vehicle weight	The sum of: (a) Curb weight (b) Accessory weight (c) Vehicle capacity weight (d) Production options weight

6-1. Specifications

Tire related term	Meaning
Normal occupant weight	150 lb. (68 kg) times the number of occupants specified in the second column of Table 1* that follows
Occupant distribution	Distribution of occupants in a vehicle as specified in the third column of Table 1* below
Production options weight	The combined weight of installed regular production options weighing over 5 lb. (2.3 kg) in excess of the standard items which they replace, not previously considered in curb weight or accessory weight, including heavy duty brakes, ride levelers, roof rack, heavy duty battery, and special trim
Rim	A metal support for a tire or a tire and tube assembly upon which the tire beads are seated
Rim diameter (Wheel diameter)	Nominal diameter of the bead seat
Rim size designation	Rim diameter and width
Rim type designation	The industry manufacturer's designation for a rim by style or code
Rim width	Nominal distance between rim flanges
Vehicle capacity weight (Total load capacity)	The rated cargo and luggage load plus 150 lb. (68 kg) times the vehicle's designated seating capacity

Tire related term	Meaning
Vehicle maximum load on the tire	The load on an individual tire that is determined by distributing to each axle its share of the maximum loaded vehicle weight, and dividing by two
Vehicle normal load on the tire	The load on an individual tire that is determined by distributing to each axle its share of curb weight, accessory weight, and normal occupant weight (distributed in accordance with Table 1* below), and dividing by two
Weather side	The surface area of the rim not covered by the inflated tire
Bead	The part of the tire that is made of steel wires, wrapped or reinforced by ply cords and that is shaped to fit the rim
Bead separation	A breakdown of the bond between components in the bead
Bias ply tire	A pneumatic tire in which the ply cords that extend to the beads are laid at alternate angles substantially less than 90 degrees to the centerline of the tread
Carcass	The tire structure, except tread and sidewall rubber which, when inflated, bears the load
Chunking	The breaking away of pieces of the tread or sidewall

6-1. Specifications

Tire related term	Meaning
Cord	The strands forming the plies in the tire
Cord separation	The parting of cords from adjacent rubber compounds
Cracking	Any parting within the tread, sidewall, or innerliner of the tire extending to cord material
CT	A pneumatic tire with an inverted flange tire and rim system in which the rim is designed with rim flanges pointed radially inward and the tire is designed to fit on the underside of the rim in a manner that encloses the rim flanges inside the air cavity of the tire
Extra load tire	A tire designed to operate at higher loads and at higher inflation pressures than the corresponding standard tire
Groove	The space between two adjacent tread ribs
Innerliner	The layer(s) forming the inside surface of a tubeless tire that contains the inflating medium within the tire
Innerliner separation	The parting of the innerliner from cord material in the carcass

Tire related term	Meaning
Intended outboard sidewall	(a)The sidewall that contains a whitewall, bears white lettering, or bears manufacturer, brand, and/or model name molding that is higher or deeper than the same molding on the other sidewall of the tire, or (b)The outward facing sidewall of asymmetrical tire that has a particular side that must always face outward when mounted on a vehicle
Light truck (LT) tire	A tire designated by its manufacturer as primarily intended for use on lightweight trucks or multipurpose passenger vehicles
Load rating	The maximum load that a tire is rated to carry for a given inflation pressure
Maximum load rating	The load rating for a tire at the maximum permissible inflation pressure for that tire
Maximum permissible inflation pressure	The maximum cold inflation pressure to which a tire may be inflated
Measuring rim	The rim on which a tire is fitted for physical dimension requirements
Open splice	Any parting at any junction of tread, sidewall, or innerliner that extends to cord material
Outer diameter	The overall diameter of an inflated new tire
Overall width	The linear distance between the exteriors of the sidewalls of an inflated tire, including elevations due to labeling, decorations, or protective bands or ribs

6-1. Specifications

Tire related term	Meaning
Passenger car tire	A tire intended for use on passenger cars, multipurpose passenger vehicles, and trucks, that have a gross vehicle weight rating (GVWR) of 10,000 lb. or less.
Ply	A layer of rubber-coated parallel cords
Ply separation	A parting of rubber compound between adjacent plies
Pneumatic tire	A mechanical device made of rubber, chemicals, fabric and steel or other materials, that, when mounted on an automotive wheel, provides the traction and contains the gas or fluid that sustains the load
Radial ply tire	A pneumatic tire in which the ply cords that extend to the beads are laid at substantially 90 degrees to the centerline of the tread
Reinforced tire	A tire designed to operate at higher loads and at higher inflation pressures than the corresponding standard tire
Section width	The linear distance between the exteriors of the sidewalls of an inflated tire, excluding elevations due to labeling, decoration, or protective bands
Sidewall	That portion of a tire between the tread and bead
Sidewall separation	The parting of the rubber compound from the cord material in the sidewall

Tire related term	Meaning
Snow tire	A tire that attains a traction index equal to or greater than 110, compared to the ASTM E-1136 Standard Reference Test Tire, when using the snow traction test as described in ASTM F-1805-00, Standard Test Method for Single Wheel Driving Traction in a Straight Line on Snow-and Ice-Covered Surfaces, and which is marked with an Alpine Symbol () on at least one sidewall
Test rim	The rim on which a tire is fitted for testing, and may be any rim listed as appropriate for use with that tire
Tread	That portion of a tire that comes into contact with the road
Tread rib	A tread section running circumferentially around a tire
Tread separation	Pulling away of the tread from the tire carcass
Treadwear indicators (TWI)	The projections within the principal grooves designed to give a visual indication of the degrees of wear of the tread
Wheel-holding fixture	The fixture used to hold the wheel and tire assembly securely during testing

6-1. Specifications

*: Table 1 — Occupant loading and distribution for vehicle normal load for various designated seating capacities

Designated seating capacity, Number of occupants	Vehicle normal load, Number of occupants	Occupant distribution in a normally loaded vehicle
2 through 4	2	2 in front
5 through 10	3	2 in front, 1 in second seat
11 through 15	5	2 in front, 1 in second seat, 1 in third seat, 1 in fourth seat
16 through 20	7	2 in front, 2 in second seat, 2 in third seat, 1 in fourth seat

6-2. Customization

Customizable features

Your vehicle includes a variety of electronic features that can be personalized to your preferences. Programming these preferences requires specialized equipment and may be performed by your Toyota dealer.

Some function settings are changed simultaneously with other functions being customized. Contact your Toyota dealer for further details.

Customizable features

- 1** Vehicles with TFT type multi-information display: Some function settings can be changed by operating the multi-information display. (→P. 652)
- 2** Settings that can be changed by your Toyota dealer
Definition of symbols: O = Available, — = Not available

6-2. Customization

Item	Function	Default setting	Customized setting	1	2
Smart key system (→P. 30)	Smart key system	ON	OFF	—	○
	Select doors to unlock	Driver's door	All doors	—	○
Wireless remote control (→P. 45)	Wireless remote control	ON	OFF	—	○
	Unlocking operation	Driver's door unlocked in one step, all doors unlocked in two step	All doors unlocked in one step	○	○
	Open door warning function (when locking the vehicle)	ON	OFF	—	○
	Panic function	ON	OFF	—	○

Item	Function	Default setting	Customized setting	1	2
Smart key system (→P. 30) and wireless remote control (→P. 45)	Operation signal (Emergency flashers)	ON	OFF	<input type="radio"/>	<input type="radio"/>
	Operation signal (Buzzer)	Level 7	Level 1 to 6	<input type="checkbox"/>	<input type="radio"/>
			OFF	<input type="checkbox"/>	<input type="radio"/>
	Time elapsed before automatic door lock function is activated if door is not opened after being unlocked	60 seconds	OFF	<input type="checkbox"/>	<input type="radio"/>
30 seconds			<input type="radio"/>	<input type="radio"/>	
			120 seconds	<input type="checkbox"/>	<input type="radio"/>
Power easy access system (→P. 75)	Driver's seat movement when exiting the vehicle	ON	OFF	<input type="checkbox"/>	<input type="radio"/>

6-2. Customization

Item	Function	Default setting	Customized setting	1	2
Door lock (→P. 50)	Unlocking using a key	Driver's door unlocked in one step, all doors unlocked in two step	All doors unlocked in one step	—	O
	Speed-detecting automatic door lock function	OFF	ON	O	O
	Shifting the shift lever to position other than "P" locks all doors	ON	OFF	O	O
	Shifting the shift lever to "P" unlocks all doors	ON	OFF	O	O
	Opening driver's door unlocks all doors	OFF	ON	O	O

Item	Function	Default setting	Customized setting	1	2
Automatic light control system (→P. 212)	Light sensor sensitivity	Level 3	Level 1 to 5	—	O
	Daytime running light system (U.S.A. only)	ON	OFF	—	O
	Automatic High Beam (if equipped)	ON	OFF	O	O
	Time elapsed before headlights automatically turn off after doors are closed	30 seconds	0 seconds		
60 seconds			O	O	
90 seconds					
Alarm system (→P. 112)	Time elapsed before the alarm is set	14 seconds	30 seconds	—	O
Multi-information display (TFT type only: →P. 194)	Language selection	English	French		
			Spanish	O	O

6

Vehicle specifications

6-2. Customization

Item	Function	Default setting	Customized setting	1	2
Illumination (→P. 430)	Time period before lights turn off	15 seconds	7.5 seconds	<input type="radio"/>	<input type="radio"/>
			30 seconds	<input type="radio"/>	<input type="radio"/>
	Vehicles with smart key system: Operation after the “ENGINE START STOP” switch is turned off Vehicles without smart key system: Operation after the engine switch is turned to the “LOCK” position	ON	OFF	<input type="checkbox"/>	<input type="radio"/>
	Operation when the doors are unlocked	ON	OFF	<input type="checkbox"/>	<input type="radio"/>
	Operation when you approach the vehicle with the electronic key on your person (When the personal/interior light main switch is door position.) (vehicles with smart key system)	ON	OFF	<input type="checkbox"/>	<input type="radio"/>

Item	Function	Default setting	Customized setting	1	2
Seat belt reminder (→P. 567)	Vehicle speed linked seat belt reminder buzzer	ON	OFF	—	O
Power window (→P. 96)	Rear window Auto Up/Down	ON	OFF	—	O
	Auto Up function	ON	OFF	—	O

**Customizing the features by using the multi-information display
(vehicles with TFT type multi-information display)**

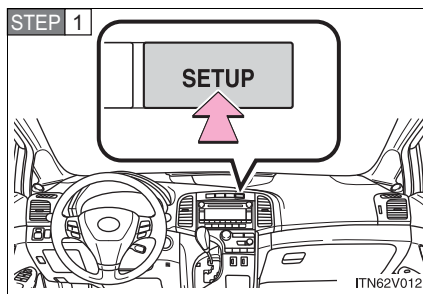

Press the “SETUP” button while the vehicle is stopped.

The “Custom Settings” screen is displayed on the multi-information display.

If left idle for approximately 10 seconds, the display will revert to the previous screen.

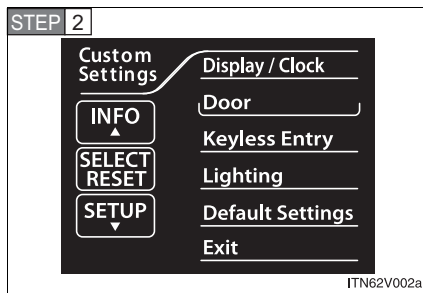

Select the setting you wish to change by pressing the “INFO” or “SETUP” button, and press the “SELECT RESET” button.

If you select “Exit” and press the “SELECT RESET” button, the display will revert to the previous screen.

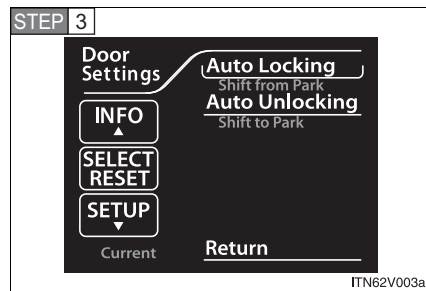

Select the setting you wish to change by pressing the “INFO” or “SETUP” button, and press the “SELECT RESET” button.

The illustration assumes that “Door” was chosen in **STEP 2**.

The current setting is indicated by yellow text.

If you select “Return” and press the “SELECT RESET” button, the display will revert to the “Custom Settings” screen.

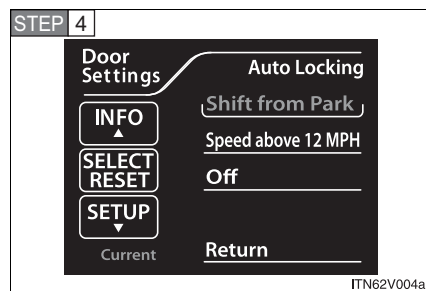

Choose a desired setting by pressing the “INFO” or “SETUP” button, and press the “SELECT RESET” button.

If any settings are changed, the display will revert to the previous screen.

The illustration assumes that “Auto Locking” was chosen in **STEP 3**.

The current setting is indicated by yellow text.

If you select “Return” and press the “SELECT RESET” button, the display will revert to the previous screen.

■ Restoring default settings

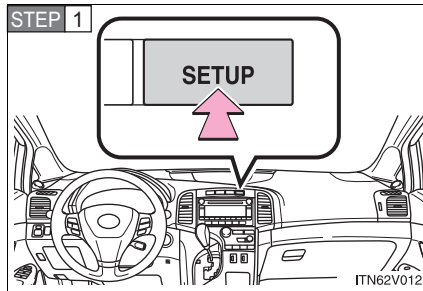

Press the "SETUP" button while the vehicle is stopped.

The "Custom Settings" screen is displayed on the multi-information display.

If left idle for approximately 10 seconds, the display will revert to the previous screen.

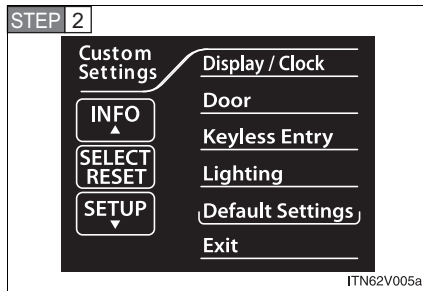

Select "Default Settings" by pressing the "INFO" or "SETUP" button, and press the "SELECT RESET" button.

If you select "Exit" and press the "SELECT RESET" button, the display will revert to the previous screen.

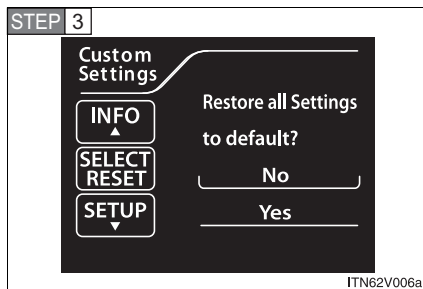

Select "Yes" by pressing the "INFO" or "SETUP" button, and press the "SELECT RESET" button.

"Default Settings Restored" is displayed, and the default settings are restored.

If you select "No" and press the "SELECT RESET" button, the display will revert to the "Custom Settings" screen without restoring the default settings.

■ If the vehicle is moved while settings are being changed on the multi-information display

→P. 204

6-3. Initialization

Items to initialize

The following items must be initialized for normal system operation in cases such as after the battery is reconnected, or maintenance is performed on the vehicle.

Item	When to initialize	Reference
Power back door	<ul style="list-style-type: none">• After reconnecting or changing the battery• After changing a fuse	P. 60
Maintenance required reminder light (U.S.A. only)	After the maintenance is performed	P. 477

6-3. Initialization

For owners

7

Reporting safety defects
for U.S. owners 658

Seat belt instructions
for Canadian owners
(in French) 659

SRS airbag instructions
for Canadian owners
(in French) 661

Reporting safety defects for U.S. owners

If you believe that your vehicle has a defect which could cause a crash or could cause injury or death, you should immediately inform the National Highway Traffic Safety Administration (NHTSA) in addition to notifying Toyota Motor Sales, U.S.A., Inc. (Toll-free: 1-800-331-4331).

If NHTSA receives similar complaints, it may open an investigation, and if it finds that a safety defect exists in a group of vehicles, it may order a recall and remedy campaign. However, NHTSA cannot become involved in individual problems between you, your dealer, or Toyota Motor Sales, U.S.A., Inc.

To contact NHTSA, you may call the Vehicle Safety Hotline toll-free at 1-888-327-4236 (TTY: 1-800-424-9153); go to <http://www.safercar.gov>; or write to: Administrator, NHTSA, 1200 New Jersey Ave, S.E., Washington, DC 20590. You can also obtain other information about motor vehicle safety from <http://www.safercar.gov>.

Seat belt instructions for Canadian owners (in French)

The following is a French explanation of seat belt instructions extracted from the seat belt section in this manual.

See the seat belt section for more detailed seat belt instructions in English.

Utilisation adéquate des ceintures de sécurité

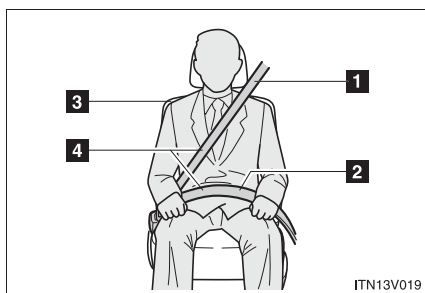

- 1** Tirez sur la ceinture épaulière jusqu'à ce qu'elle recouvre entièrement l'épaule; elle ne doit cependant pas toucher le cou ni glisser de l'épaule.
- 2** Placez la sangle abdominale le plus bas possible sur les hanches.
- 3** Réglez la position du dossier du siège. Tenez-vous assis dans le fond du siège, le dos droit.
- 4** Ne vrillez pas la ceinture de sécurité.

Entretien et soin

■ Ceintures de sécurité

Avec un tissu ou une éponge, nettoyez à l'aide d'un savon doux et de l'eau tiède. Vérifiez aussi les ceintures régulièrement pour vous assurer qu'elles ne présentent pas d'usure excessive, d'effilochage ou de coupures.

ATTENTION

■ Dommages et usure de la ceinture de sécurité

Vérifiez périodiquement le système de ceintures de sécurité. Assurez-vous qu'il n'y a pas de coupures, d'effilochures ni de pièces desserrées. N'utilisez pas une ceinture de sécurité endommagée avant qu'elle soit remplacée. Les ceintures de sécurité endommagées ne peuvent pas protéger les occupants contre les blessures.

SRS airbag instructions for Canadian owners (in French)

The following is a French explanation of SRS airbag instructions extracted from the SRS airbag section in this manual.

See the SRS airbag section for more detailed SRS airbag instructions in English.

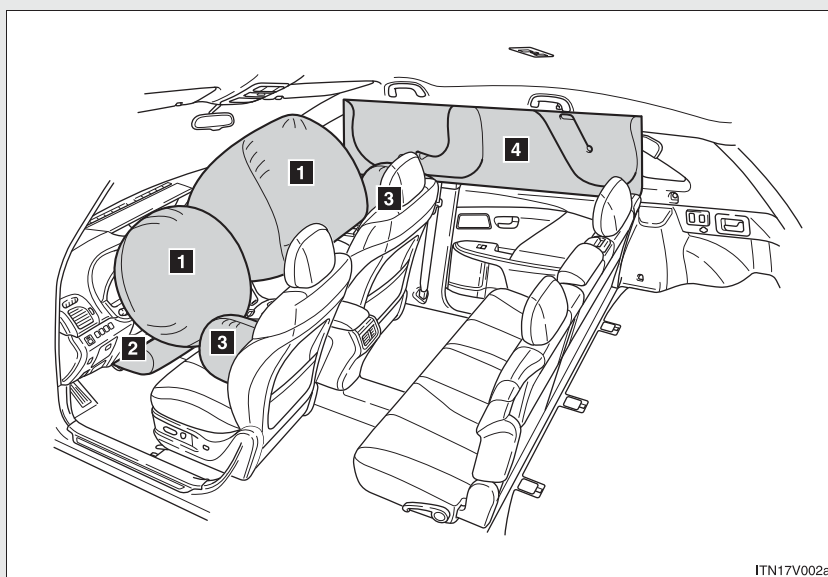

► Coussins gonflables avant

- 1** Coussins gonflables du conducteur/du passager avant
Peuvent protéger la tête et la poitrine du conducteur et du passager avant contre les impacts avec des composants intérieurs.
- 2** Coussin de protection des genoux
Peut protéger le conducteur.



► Coussins gonflables latéraux et en rideau

■ **3** Coussins gonflables latéraux

Peuvent protéger le torse des occupants des sièges avant.

■ **4** Coussins gonflables en rideau

Peuvent surtout protéger la tête des occupants sièges avant et des occupants des sièges latéraux arrière.

Composants du système de coussins gonflables

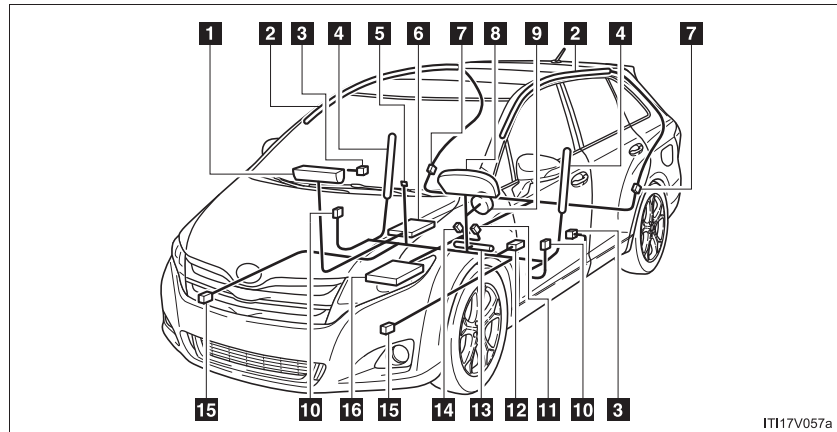

- | | |
|---|--|
| 1 Coussin gonflable du passager avant | 10 Capteurs d'impact latéral (portière avant) |
| 2 Coussin gonflable en rideau | 11 Contacteur de boucle de ceinture de sécurité du conducteur |
| 3 Dispositifs de tension et limiteurs de force des ceintures de sécurité | 12 Capteur de position de siège du conducteur |
| 4 Coussin gonflable latéral | 13 Coussin de protection des genoux |
| 5 Lampe témoin "AIR BAG ON/OFF" | 14 Contacteur de boucle de ceinture de sécurité du passager avant |
| 6 Système de classification de l'occupant du siège du passager avant (ECU et capteurs) | 15 Capteurs d'impact avant |
| 7 Capteurs d'impact latéral (arrière) | 16 Module de capteur de coussin gonflable |
| 8 Lampe témoin SRS | |
| 9 Coussin gonflable du conducteur | |



Votre véhicule est doté de “COUSSINS GONFLABLES ÉVOLUÉS” dont la conception s’appuie sur les normes de sécurité des véhicules à moteur américains (FMVSS208). Le module de capteur de coussin gonflable (ECU) contrôle le déploiement des coussins gonflables en fonction des informations obtenues des capteurs et d’autres éléments affichés dans le diagramme des composants du système ci-dessus. Ces informations comprennent des données relatives à la gravité de l’impact et aux passagers. Au moment du déploiement des coussins gonflables, une réaction chimique se produit dans les gonfleurs et les coussins gonflables se remplissent rapidement d’un gaz non toxique pour limiter le mouvement des occupants.

 ATTENTION

■ **Précautions relatives aux coussins gonflables SRS**

Observez les précautions suivantes en ce qui concerne les coussins gonflables.

Les négliger pourrait occasionner des blessures graves, voire mortelles.

- Le conducteur et tous les passagers du véhicule doivent porter leur ceinture de sécurité de la manière appropriée.

Les coussins gonflables SRS sont des dispositifs supplémentaires qui doivent être utilisés de concert avec les ceintures de sécurité.

- Le coussin gonflable SRS du conducteur se déploie avec une force considérable et peut occasionner des blessures graves, voire mortelles, notamment lorsque le conducteur se trouve très près du coussin gonflable. La National Highway Traffic Safety Administration (“NHTSA”), aux États-Unis, donne les recommandations suivantes:

La zone à risque d'un coussin gonflable côté conducteur couvre 2 à 3 in. (50 à 75 mm) de la zone de déploiement du coussin gonflable. Pour assurer une marge de sécurité suffisante, restez à 10 in. (250 mm) du coussin gonflable. Cette distance est mesurée depuis le centre du volant jusqu'à votre sternum. Si vous vous tenez à moins de 10 in. (250 mm), vous pouvez changer votre position de conduite de plusieurs manières:

- Reculez votre siège à la position maximale vous permettant d'atteindre encore aisément les pédales.
- Inclinez légèrement le dossier du siège.
Même si les véhicules sont conçus différemment, la plupart des conducteurs peuvent maintenir une distance de 10 in. (250 mm), même si le siège se trouve complètement vers l'avant, simplement en inclinant un peu le dossier du siège vers l'arrière. Si la visibilité avant est moindre après avoir incliné le dossier du siège, utilisez un coussin ferme et non glissant pour être assis plus haut ou relevez l'assise du siège si cette option est disponible sur votre véhicule.
- Si votre volant est réglable en hauteur, inclinez-le vers le bas. Cela vous permet d'orienter le coussin gonflable vers votre buste plutôt que vers la tête et le cou.

Le siège doit être réglé de la manière recommandée ci-dessus par la NHTSA, tout en gardant le contrôle des pédales, du volant et la vue des commandes et des instruments.

! ATTENTION

■ Précautions relatives aux coussins gonflables SRS

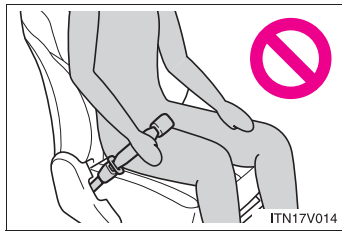

- Si la rallonge de ceinture de sécurité a été reliée à la boucle des ceintures de sécurité des sièges avant sans avoir été attachée à la plaque de blocage des ceintures de sécurité, les coussins gonflables SRS avant considéreront que le conducteur et le passager avant portent tout de même leur ceinture même si elles ne sont pas attachées. Les coussins gonflables SRS avant peuvent alors ne pas s'activer correctement lors d'une collision, ce qui représente un risque de blessures graves, voire mortelles. Bouclez toujours votre ceinture de sécurité lorsque vous utilisez la rallonge.
- Le coussin gonflable SRS du passager avant se déploie également avec une force considérable et peut occasionner des blessures graves, voire mortelles, notamment lorsque le passager avant se trouve très près du coussin gonflable. Le siège du passager avant doit se trouver le plus loin possible du coussin gonflable et le dossier doit être réglé de manière à ce que le passager avant soit assis bien droit.

 **ATTENTION****■ Précautions relatives aux coussins gonflables SRS**

- Le déploiement d'un coussin gonflable risque d'infliger des blessures graves, voire mortelles, aux bébés et aux enfants mal assis et/ou mal attachés. Un bébé ou un enfant trop petit pour utiliser une ceinture de sécurité doit être correctement retenu à l'aide d'un dispositif de retenue pour enfants. Toyota recommande vivement de placer et d'attacher correctement tous les bébés et enfants sur les sièges arrière du véhicule à l'aide de systèmes de retenue adaptés. Les sièges arrière constituent en effet l'endroit le plus sûr pour les bébés et les enfants.
- N'installez jamais un dispositif de retenue pour enfants de type dos à la route sur le siège du passager avant, même si la lampe témoin "AIR BAG OFF" s'allume. En cas d'accident, la force et la vitesse de déploiement du coussin gonflable du passager avant sont telles qu'elles pourraient infliger à l'enfant des blessures graves, voire mortelles, si le dispositif de retenue pour enfants du type dos à la route était installé sur le siège du passager avant.

ATTENTION

■ Précautions relatives aux coussins gonflables SRS

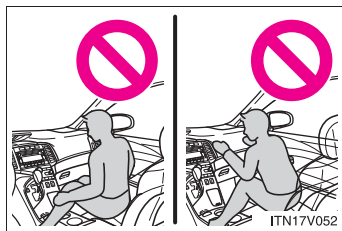

- Ne vous asseyez pas sur le bord du siège et ne vous appuyez pas sur le tableau de bord.

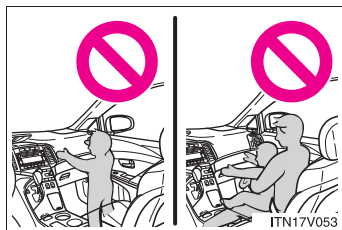

- Ne laissez pas un enfant se tenir face au coussin gonflable SRS du passager avant ou s'asseoir sur les genoux d'un passager avant.
- Ne conduisez pas le véhicule si vous ou le passager avez quelque chose sur les genoux.



- Ne vous appuyez pas sur la portière ou sur le longeron du toit, ni sur les montants avant, centraux ou arrière.



- Ne laissez personne s'agenouiller face à la portière sur le siège du passager ou sortir la tête ou les mains à l'extérieur du véhicule.

ATTENTION

■ Précautions relatives aux coussins gonflables SRS

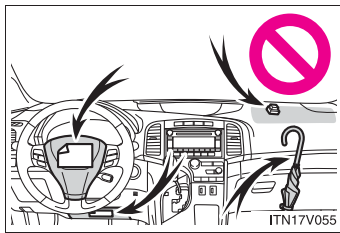

● Ne fixez et n'appuyez rien sur le tableau de bord, le tampon de volant ou la partie inférieure du bloc d'instrumentation. Ces objets peuvent se transformer en projectiles lorsque les coussins gonflables SRS du conducteur, du passager avant ou de protection des genoux se déploient.

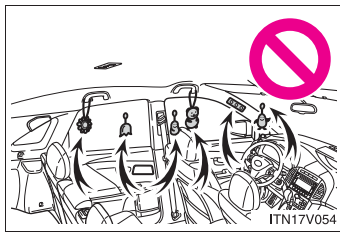

● Ne fixez rien sur les portières, le pare-brise, les glaces latérales, les montants avant, central et arrière, le longeron du toit ou la poignée de maintien.

● N'accrochez pas de cintres ni d'autres objets rigides sur les crochets porte-vêtements. Tous ces objets pourraient se transformer en projectiles et vous occasionner des blessures graves, voire mortelles, en cas de déploiement du coussin gonflable SRS en rideau.

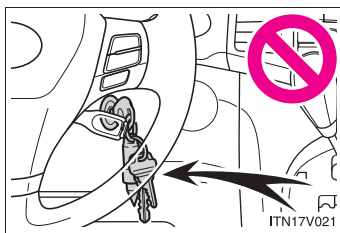

● Véhicules non dotés du système Smart key: N'accrochez pas d'objets lourds, aiguisés ou durs, par exemple des clés ou des accessoires, à la clé. Ces objets pourraient empêcher le déploiement du coussin SRS de protection des genoux ou être projetés dangereusement sur le siège du conducteur par la force du déploiement, et donc vous mettre en danger.

 ATTENTION

■ **Précautions relatives aux coussins gonflables SRS**

- Si le recouvrement de vinyle est placé sur la zone de déploiement du coussin SRS de protection des genoux, veillez à le retirer.
- N'utilisez pas d'accessoires recouvrant les parties du siège où les coussins gonflables SRS latéraux se déploient, car ceux-ci pourraient nuire au déploiement de ces coussins.
- Ne frappez pas et n'appliquez pas une pression importante à l'emplacement des composants de coussins gonflables SRS. Ces actions peuvent entraîner un mauvais fonctionnement des coussins gonflables SRS.
- Ne touchez à aucun composant des coussins gonflables SRS immédiatement après leur déploiement (gonflage), car ils pourraient être chauds.
- Si vous avez de la difficulté à respirer après le déploiement d'un coussin gonflable SRS, ouvrez une portière ou une glace pour laisser entrer l'air, ou quittez le véhicule si vous pouvez le faire en toute sécurité. Dès que possible, nettoyez tous les résidus afin d'éviter les irritations cutanées.
- Si les emplacements de stockage des coussins gonflables SRS, notamment le tampon de volant et les garnitures des montants avant, central et arrière, sont endommagés ou fissurés, faites-les remplacer par votre concessionnaire Toyota.

 **ATTENTION**

■ Modification et mise au rebut des composants du système de coussins gonflables SRS

Ne mettez pas le véhicule à la casse et n'effectuez aucune des modifications suivantes sans d'abord consulter votre concessionnaire Toyota.

Le coussin gonflable SRS pourrait fonctionner de manière incorrecte ou se déployer (gonfler) accidentellement, ce qui serait susceptible d'occasionner des blessures graves, voire mortelles.

- Installation, retrait, démontage et réparation des coussins gonflables SRS
- Réparations, modifications, retrait ou remplacement du volant, du bloc d'instrumentation, du tableau de bord, des sièges ou du capitonnage des sièges, des montants avant, central ou arrière et du longeron du toit
- Réparations ou modifications de l'aile ou du pare-chocs avant, ou du côté de l'habitacle
- Installation de lames de déneigement, de treuils, etc. sur la calandre avant (barre safari, barre kangourou, etc.)
- Modifications du système de suspension du véhicule
- Installation d'appareils électroniques tels qu'un émetteur-récepteur radio ou un lecteur de CD
- Modifications à votre véhicule pour une personne aux capacités physiques réduites



672

VENZA_OM_OM73023U_(U)

Index

Abbreviation list	674
Alphabetical index	676
What to do if...	685

For vehicles with an Entune Premium Audio with Navigation or Entune Audio Plus, refer to the “NAVIGATION AND MULTIMEDIA SYSTEM OWNER’S MANUAL” for information regarding the equipment listed below.

- Navigation system
- Audio system

Abbreviation list

Abbreviation/Acronym list

ABBREVIATIONS	MEANING
2WD	2-Wheel Drive
4WD	4-Wheel Drive
ABS	Anti-lock Brake System
ACC	Accessory
ALR	Automatic Locking Retractor
AUX	Auxiliary
AWD	All-Wheel Drive
A/C	Air Conditioning
CRS	Child Restraint System
ECON	Economy
ECU	Electronic Control Unit
EDR	Event Data Recorder
ELR	Emergency Locking Retractor
EPS	Electric Power Steering
GAWR	Gross Axle Weight Rating
GCWR	Gross Combination Weight Rating
GVWR	Gross Vehicle Weight Rating
INFO	Information
I/M	Emission inspection and maintenance
LATCH	Lower Anchors and Tether for Children
LCD	Liquid Crystal Display
LED	Light Emitting Diode
MMT	Methylcy clopentadienyl Manganese Tricarbonyl
M+S	Mud and Snow
MTBE	Methyl Tertiary Butyl Ether

ABBREVIATIONS	MEANING
OBD	On Board Diagnostics
PASS	Passenger
PWR	Power
P/S	Power Steering
SRS	Supplemental Restraint System
TEMP	Temperature
TFT	Thin Film Transistor
TIN	Tire Identification Number
TPMS	Tire Pressure Warning System
TRAC	Traction Control
VIN	Vehicle Identification Number
VSC	Vehicle Stability Control

Alphabetical index

Alphabetical index

A

A/C	
Air conditioning filter.....	520
Automatic air conditioning system	306
ABS	256
Active head restraint	68
Active Torque Control 4WD system	257
Air conditioning filter.....	520
Air conditioning system	
Air conditioning filter.....	520
Automatic air conditioning system	306
Airbags	
Airbag operating conditions...	123
Airbag precautions for your child	128
Airbag warning light.....	566
Curtain shield airbag operating conditions.....	123
Curtain shield airbag precautions	128
Front passenger occupant classification system	135
General airbag precautions...	128
Locations of airbags.....	119
Modification and disposal of airbags	133
Proper driving posture.....	117
Side airbag operating conditions.....	123
Side airbag precautions	128
SRS airbags	119
Alarm.....	112
Anti-lock brake system.....	256
Armrest	451
Assist grips	452
Audio input	325

Audio system

(Entune Audio).....	318
Basic Audio Operations	326
CD player.....	343
iPod.....	350
Listening to Bluetooth®	
Audio	377
Radio.....	340
Steering wheel audio switches.....	323
USB memory.....	356
USB port/AUX Port	325
Using a Bluetooth®	
Phone	379
Using the AUX port	362
Automatic air conditioning system	306
Automatic headlight leveling system	215
Automatic High Beam	216
Automatic light control system	212
Automatic transmission	
Automatic transmission.....	180
If the shift lever cannot be shifted from "P"	593
S mode.....	182
AUX port/USB port.....	325
Auxiliary box	442

B

Back door	
Back door.....	56
Wireless remote control key....	45
Back-up lights	
Replacing light bulbs.....	548
Wattage.....	624
Battery	
Checking	502
If the vehicle has discharged battery	598

Bluetooth®	419
Wireless communication	363
Bluetooth® audio	377
Bottle holder	441
Brake	
Fluid.....	500
Parking brake	186
Brake assist	256
Break-in tips	164
Brightness control	
Instrument light control	189
C	
Care	
Exterior	470
Interior	473
Seat belts	474
Cargo capacity	269
Cargo hooks	455
CD player	343
Chains	278
Child-protectors	52
Child restraint system	
Booster seats, definition	140
Booster seats, installation	146
Convertible seats,	
definition.....	140
Convertible seats,	
installation	146
Front passenger occupant	
classification system	134
Infant seats, definition	140
Infant seats, installation.....	146
Installing child restraint	
system with lower	
anchorages	147
Installing child restraint	
system with seatbelts.....	150
Installing child restraint	
system with top tether	
strap	155

Child safety

Airbag precautions	128
Back door precautions	61
Battery precautions	504, 526
Child-protectors.....	52
Child restraint system.....	140
How your child should wear	
the seat belt	83
Installing child restraints.....	146
Moon roof precautions	103
Power window lock switch.....	96
Power window precautions	99
Removed key battery	
precautions	526
Seat belt extender	
precautions	87
Seat belt precautions	84
Seat heater precautions	450
Cleaning	
Exterior.....	470
Interior.....	473
Seat belts	474
Clock	194, 206
Compass	464
Condenser	499
Console box	436
Cooling system	
Engine overheating	603
Cruise control	231
Cup holders	439
Curtain shield airbags	119
Customizable features	645

D	Daytime running light system	214
	Defogger	
	Rear window	316
	Dimension	612
	Dinghy towing	302
	Display	
	Fuel consumption information	210
	Shift position and shift range.....	182
	Trip information	194, 206
	Warning messages	578
	Do-it-yourself maintenance	483
	Door courtesy lights	
	Door courtesy lights	430
	Wattage.....	624
	Door lock	
	Back door	56
	Side door.....	50
	Wireless remote control key....	45
	Doors	
	Back door.....	56
	Side door.....	50
	Side mirrors.....	92
	Driver's seat belt reminder light	567
	Driving	
	Break-in tips	164
	Correct posture	117
	Procedures.....	162
	Utility vehicle precautions.....	264
	Winter driving tips.....	276
	Driving position memory	73
E	Electric power steering	256
	Electronic key	
	If your electronic key battery is discharged...	523, 595

Emergency, in case of	
If a warning message is displayed	578
If the electronic key does not operate properly	595
If the engine will not start	590
If the shift lever cannot be shifted from "P"	593
If the vehicle has discharged battery	598
If the warning buzzer sounds	564
If the warning light turns on...	564
If you have a flat tire	579
If you lose your keys	594
If you think something is wrong.....	561
If your vehicle becomes stuck	606
If your vehicle has to be stopped in an emergency ...	608
If your vehicle needs to be towed	555
If your vehicle overheats	603
Emergency flashers	554
Engine	
Compartment	491
Engine switch.....	173, 177
Hood	487
How to start the engine.....	173, 177
Identification number.....	613
If the engine will not start	590
Ignition switch	173, 177
Overheating	603
Engine coolant	
Capacity	618
Checking	497
Preparing and checking before winter	276

Engine coolant temperature gauge	188
Engine immobilizer system	109
Engine oil	
Capacity	616
Checking	493
Preparing and checking before winter	276
Engine switch	173, 177
Entune Audio Plus*	
EPS	256
Event data recorder	23
F	
Floor mat	453
Fluid	
Brake	500
Washer	505
Fog lights	
Replacing light bulbs	543
Switch	223
Wattage	624
Four-wheel drive system	257
Front fog lights	
Replacing light bulbs	543
Switch	223
Wattage	624
Front passenger occupant classification system	134
Front passenger's seat belt reminder light	567
Front seats	
Adjustment	67
Driving position memory	73
Front side marker light	
Replacing light bulbs	546
Wattage	624
Front turn signal lights	
Replacing light bulbs	544
Wattage	624

Fuel	
Capacity	615
Fuel gauge	188
Fuel pump shut off system	564
Information	626
Refueling	105
Type	626
Fuel door	105
Fuel filler door	105
Fuel pump shut off system	564
Fuses	527
G	
Garage door opener	457
Gauges	188
Glove box	435
Glove box light	435
H	
Hands-free system (for cellular phone)	379
HD Radio® system*	
Head restraints	
Adjusting	78
Headlights	
Replacing light bulbs	537
Switch	212
Wattage	624
Heaters	
Seat heaters	449
Side mirror	316
Hill-start assist control	262
Hood	487
Hooks	
Cargo hook.....	455
Shopping bag hooks	455
Horn	187

*: Refer to "NAVIGATION AND MULTIMEDIA SYSTEM OWNER'S MANUAL".

I	I/M test.....482
	Identification
	Engine614
	Vehicle613
	Ignition
	Engine switch173, 177
	Keys28
	Ignition switch.....173, 177
	Ignition switch.....173, 177
	Illuminated entry system.....430
	Indicator lights191
	Initialization
	Items to initialize.....655
	Inside rear view mirror89
	Instrument panel light
	control189
	Interior lights
	Interior lights.....430
	Switch.....431
	Wattage.....624
	Intuitive parking assist235
J	Jack
	Positioning a floor jack489
	Vehicle-equipped jack579
	Jack handle579
K	Keyless entry.....30
	Keys
	Electronic key.....28
	If you lose your keys594
	If your electronic key
	battery is discharged...523, 595
	Ignition switch.....173, 177
	Keyless entry.....30
	Key number.....28
	Keys28
	Mechanical key28
	Wireless remote control key....45
	Knee airbag119

L	Language
	Multi-information
	display194, 645
	Licence plate lights
	Replacing light bulbs.....549
	Wattage.....624
	Light bulbs
	Replacing537
	Wattage.....624
	Lights
	Door courtesy lights430
	Emergency flasher switch554
	Fog light switch223
	Headlights switch212
	Interior light switch431
	Personal light switch432
	Replacing light bulbs.....537
	Turn signal lever185
	Vanity lights.....446
	Wattage.....624
	Load capacity.....274
	Lock steering
	column.....175, 178
	Luggage compartment light
	Switch432
	Wattage.....624
	Luggage cover455

M	Maintenance	
	Do-it-yourself maintenance ..	483
	General maintenance	479
	Maintenance data	612
	Maintenance requirements...	476
	Reset the maintenance data	477
	Meter	
	Instrument panel light control	189
	Meters	188
	Mirrors	
	Inside rear view mirror	89
	Side mirrors	92
	Vanity mirrors	446
	Moon roof	100
	MP3 disc	343
	Multi-information display	194, 206
N	Navigation system*	
	Noise from under vehicle	20
O	Odometer	188
	Oil	
	Engine oil	493
	Opener	
	Back door	56
	Fuel filler door	105
	Hood	487
	Outside rear view mirrors	
	Adjusting and folding	92
	Outside temperature display	194, 206
	Overhead console	438
	Overheating, Engine	603

P	Parking brake	186
	Parking lights	
	Replacing light bulbs	544
	Switch	212
	Wattage	624
	Personal lights	
	Switch	432
	Wattage	624
	Power back door	56
	Power outlet	447
	Power windows	96
R	Radiator	499
	Radio	340
	Radio Broadcast Data System (RBDS)*	341
	Rear seats	
	Adjustment	70
	Folding down rear seatback ...	70
	Rear side marker lights	
	Replacing light bulbs	547
	Wattage	624
	Rear turn signal lights	
	Replacing light bulbs	547
	Wattage	624
	Rear view mirror	
	Inside	89
	Outside	92
	Compass	464
	Rear view monitor system	243
	Rear window defogger	316
	Rear window wiper	229
	Replacing	
	Fuses	527
	Key battery	523
	Light bulbs	537
	Tires	579
	Reporting safety defects for U.S. owners	658
	Resetting the maintenance required reminder light	477

*: Refer to "NAVIGATION AND MULTIMEDIA SYSTEM OWNER'S MANUAL".

S	Seat belts	
	Adjusting the seat belt.....	82
	Automatic Locking	
	Retractor.....	83
	Child restraint system	
	installation.....	146
	Cleaning and maintaining	
	the seat belts.....	474
	Emergency Locking	
	Retractor.....	83
	How to wear your seat belt.....	81
	How your child should wear	
	the seat belt.....	83
	Pregnant women,	
	proper seat belt use.....	85
	Reminder light.....	567
	Seat belt extenders.....	84
	Seat belt instructions for	
	Canadian owners.....	659
	Seat belt pretensioners.....	82
	Seat heaters.....	449
	Seating capacity.....	274
	Seats	
	Adjustment precautions.....	69
	Child seats/child restraint	
	system installation.....	146
	Cleaning.....	473
	Driving position memory.....	73
	Front seat adjustment.....	67
	Head restraint.....	78
	Properly sitting in the seat.....	117
	Rear seat adjustment.....	70
	Seat heaters.....	449
	Service reminder	
	indicators.....	191
	Shift lever	
	Automatic transmission.....	180
	If the shift lever cannot be	
	shifted from P.....	593
	Shift lock system.....	593
	Shopping bag hooks.....	455
	Side airbags.....	119
	Side marker lights	
	Replacing light bulbs.....	546, 547
	Switch.....	212
	Wattage.....	624
	Side mirror	
	Adjusting and folding.....	92
	Smart key system	
	Entry function.....	30
	Starting the engine.....	173
	Spare tire	
	Inflation pressure.....	513
	Storage location.....	579
	Spark plug.....	619
	Specifications.....	612
	Speedometer.....	188
	Steering	
	Adjustment.....	88
	Switches.....	323, 396
	Column lock release.....	175, 178
	Stop lights	
	Replacing light bulbs.....	547
	Wattage.....	624
	Storage feature.....	434
	Storage precautions.....	269
	Stuck	
	If your vehicle becomes	
	stuck.....	606
	Sun visors.....	445
	Sunshade	
	Roof.....	104

Switch

Driving position memory
 switches 73
 Emergency flasher switch 554
 Engine switch 173, 177
 Fog light switch..... 223
 Ignition switch..... 173, 177
 Intuitive parking assist
 switch 235
 Light switches..... 212
 Power back door 56
 Power door lock switch..... 51
 Power window switch 96
 Rear window wiper and
 washer switch 229
 Steering wheel
 switches 323, 396
 Talk switch* 426
 Telephone switches..... 396
 Window lock switch 96
 Wipers and washer switch.... 225

T

Tachometer 188
Tail lights
 Replacing light bulbs 547
 Switch 212
 Wattage 624
Talk switch* 426
Telephone switches 396
Theft deterrent system
 Alarm 112
 Engine immobilizer system... 109
Theft prevention labels..... 116
Tire inflation pressure 513
**Tire pressure warning
 system** 507

Tire information

Glossary637
 Size633
 Tire identification number.....632
 Uniform tire quality grading ...635

Tires

Chains278
 Checking506
 If you have a flat tire.....579
 Inflation pressure.....513
 Information630
 Pressure warning system.....507
 Replacing579
 Rotating tires506
 Size622
 Snow tires276
 Spare tire.....579

Tonneau cover456

Tools579

Total load capacity.....274

Towing

Dinghy towing.....302
 Emergency towing.....555
 Trailer towing.....281

TRAC256

Traction control.....256

Trailer towing281

Trip information

display194, 206

Trip meter 188

Turn signal lights

Replacing light bulbs544, 547
 Switch..... 185
 Wattage.....624

U

USB port325

Utility vehicle precautions264

*: Refer to "NAVIGATION AND MULTIMEDIA SYSTEM OWNER'S MANUAL".

Alphabetical index

- V**
- Vanity lights**
 - Vanity lights 446
 - Wattage 624
 - Vanity mirrors** 446
 - Vehicle identification number** 613
 - Vehicle stability control** 256
 - Voice command system*** 426
 - VSC** 256
- W**
- Warning buzzers**
 - Brake system 564
 - Open door 567
 - Seat belt reminder 567
 - Warning lights**
 - Active Torque Control 4WD system 568
 - Automatic headlight leveling system 566
 - Anti-lock brake system 566
 - Brake system 564
 - Charging system 565
 - Electric power steering 566
 - Engine oil pressure 565
 - Low fuel level 568
 - Maintenance required reminder 569
 - Malfunction indicator lamp 565
 - Master warning 568
 - Open door 567
 - Seat belt reminder 567
 - SRS airbags 566
 - Tire pressure 567
 - Washer fluid 568
 - Warning messages** 578
 - Washer**
 - Checking 505
 - Preparing and checking before winter 276
 - Switch 225, 229
 - Washing and waxing** 470
 - Weight**
 - Cargo capacity 269
 - Load limits 274
 - Weight 612
 - Wheels** 517
 - Window glasses** 96
 - Window lock switch** 96
 - Windows**
 - Power windows 96
 - Rear window defogger 316
 - Washer 225
 - Windshield wiper de-icer** 316
 - Windshield wipers** 225
 - Wireless remote control key**
 - Replacing the battery 523
 - Wireless remote control key 45
 - WMA disc** 343
- X**
- XM® Satellite Radio***

*: Refer to "NAVIGATION AND MULTIMEDIA SYSTEM OWNER'S MANUAL".

What to do if...
 What to do if...

A tire punctures	P. 579	If you have a flat tire
The engine does not start	P. 109	Engine immobilizer system
	P. 590	If the engine will not start
	P. 598	If the battery is discharged
The shift lever cannot be moved out	P. 593	If the shift lever cannot be shifted from "P"
The engine coolant temperature gauge enters the red zone	P. 603	If your vehicle overheats
Steam can be seen coming from under the hood		
The key is lost	P. 594	If you lose your keys
The battery runs out	P. 598	If the battery is discharged
The doors cannot be locked	P. 50	Side doors
	P. 56	Back door
The horn begins to sound	P. 112	Alarm
The vehicle is stuck in mud or sand	P. 606	If the vehicle becomes stuck

What to do if...

The warning light or indicator light comes on

P. 564

If the warning light turns on or a warning buzzer sounds...



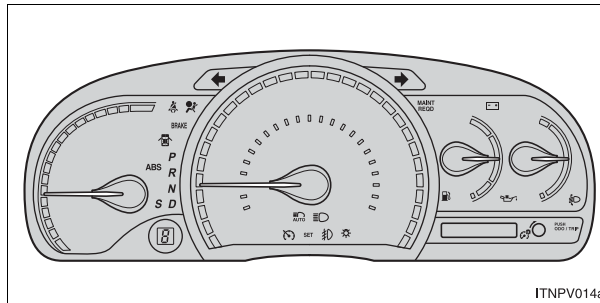



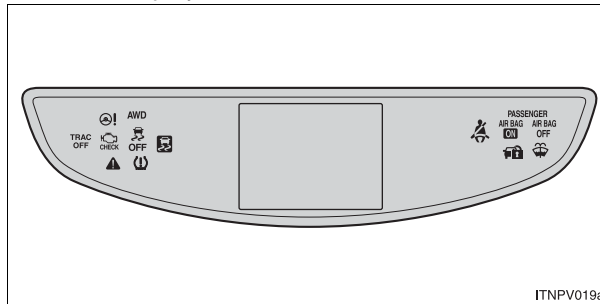











► Instrument cluster



► Center display



■ **Warning lights**

 Master warning light P. 568	 Automatic High Beam indicator light* P. 566
 Low engine oil pressure warning light P. 565	 Open door warning light P. 567
 Charging system warning light P. 565	 Tire pressure warning light P. 567
 Malfunction indicator lamp P. 565	MAINT REQD Maintenance required reminder light P. 569
BRAKE Brake system warning light or  P. 564	 Driver's seat belt reminder light P. 567
 Automatic headlight leveling system warning light P. 566	 Front passenger's seat belt reminder light P. 567
 SRS warning light P. 566	 Low fuel level warning light P. 568
ABS ABS warning light or  P. 566	 Electric power steering system warning light P. 566
 Slip indicator light P. 566	 Low windshield washer fluid level warning light P. 568
 Cruise control indicator light* P. 566	 Smart key system warning light P. 570
	AWD 4WD system warning light P. 568

*: The light flashes to indicate a malfunction.

The warning message is
displayed

P. 578 If a warning message is displayed

GAS STATION INFORMATION

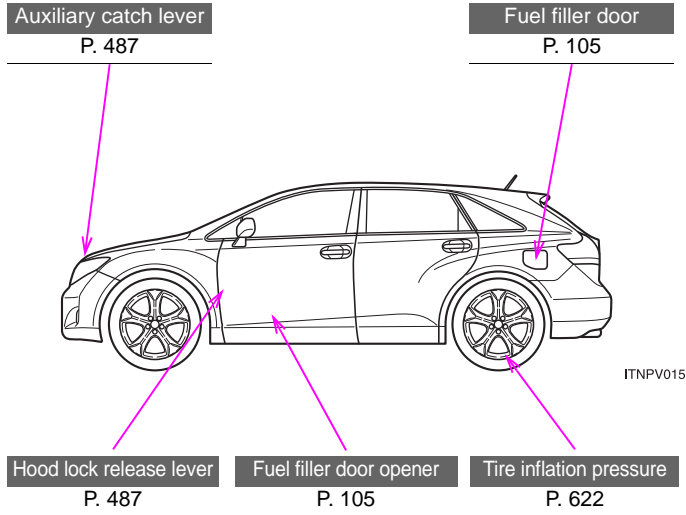

Fuel tank capacity (Reference)	17.7 gal. (67 L, 14.7 Imp.gal.)	
Fuel type	Unleaded gasoline only	P. 615
Cold tire inflation pressure		P. 622
Engine oil capacity (Drain and refill — reference)		qt. (L, Imp.qt.)
	With filter	2GR-FE engine 6.4 (6.1, 5.4) 1AR-FE engine 4.6 (4.4, 3.9)
	Without filter	2GR-FE engine 6.0 (5.7, 5.0) 1AR-FE engine 4.2 (4.0, 3.5)
Engine oil type	"Toyota Genuine Motor Oil" or equivalent Oil grade P. 616 ILSAC GF-5 multigrade engine oil Recommended oil viscosity 0W-20	