

TABLE OF CONTENTS

1	Before driving	Adjusting and operating features such as door locks, mirrors, and steering column.
2	When driving	Driving, stopping, and safe-driving information.
3	Interior features	Air conditioning and multimedia systems, as well as other interior features for a comfortable driving experience.
4	Maintenance and care	Cleaning and protecting your vehicle, performing do-it-yourself maintenance, and maintenance information.
5	When trouble arises	What to do if the vehicle needs to be towed, gets a flat tire, or is involved in an accident.
6	Vehicle specifications	Detailed vehicle information.
7	For owners	Reporting safety defects for U.S. owners, and seat belt and SRS airbag instructions for Canadian owners.
	Index	Alphabetical listing of information contained in this manual.

Refer to “NAVIGATION SYSTEM OWNER’S MANUAL” for information regarding the equipment listed below.

- Multimedia system
- Rear view monitor system

1 Before driving

<p>1-1. Key information</p> <p>Keys 30</p> <p>1-2. Opening, closing and locking the doors</p> <p>Wireless remote control 31</p> <p>Side doors 35</p> <p>Back door 40</p> <p>1-3. Adjustable components (seats, mirrors, steering wheel)</p> <p>Front seats 48</p> <p>Rear seats 51</p> <p>Driving position memory (driver's seat) 62</p> <p>Head restraints 65</p> <p>Seat belts 69</p> <p>Steering wheel (manually adjustable type)..... 79</p> <p>Steering wheel (power-adjustable type)..... 80</p> <p>Anti-glare inside rear view mirror..... 81</p> <p>Outside rear view mirrors 84</p> <p>Roof luggage carrier..... 88</p>	<p>1-4. Opening and closing the windows and moon roof</p> <p>Power windows..... 90</p> <p>Power back window 93</p> <p>Moon roof 96</p> <p>1-5. Refueling</p> <p>Opening the fuel tank cap..... 100</p> <p>1-6. Theft deterrent system</p> <p>Engine immobilizer system 105</p> <p>Alarm 107</p> <p>1-7. Safety information</p> <p>Correct driving posture 110</p> <p>SRS airbags 112</p> <p>Front passenger occupant classification system..... 124</p> <p>Child restraint systems 129</p> <p>Installing child restraints 133</p>
---	---

2 When driving

2-1. Driving procedures

Driving the vehicle.....	148
Engine (ignition) switch	158
Automatic transmission.....	161
Turn signal lever	165
Parking brake.....	166
Horn	167

2-2. Instrument cluster

Gauges and meters	168
Indicators and warning lights	173
Multi-information display	178
Accessory meter	184

2-3. Operating the lights and wipers

Headlight switch.....	187
Fog light switch	193
Windshield wipers and washer	195
Rear window wiper and washer	199
Headlight cleaner switch.....	201

2-4. Using other driving systems

Cruise control.....	202
Dynamic laser cruise control	206
Intuitive parking assist.....	220
BSM (Blind Spot Monitor) ...	227
Electronically modulated air suspension.....	233

AVS (Adaptive Variable Suspension System)	238
Four-wheel drive system	239
AUTO LSD system	244
Driving assist systems.....	246

2-5. Driving information

Off-road precautions.....	254
Cargo and luggage.....	259
Vehicle load limits.....	264
Winter driving tips.....	266
Trailer towing.....	270
Dinghy towing.....	290

3 Interior features

3-1. Using the air conditioning system and defogger

Front air conditioning system.....	294
Rear air conditioning system.....	303
Rear window and outside rear view mirror defoggers.....	307
Windshield wiper de-icer	309

3-2. Using the multimedia system

Multimedia system types	310
USB port/AUX port	311
Using the AUX port.....	312

3-3. Using the interior lights

Interior lights list	313
• Personal/interior light main switch	314

- Personal/interior lights..... 315
- Interior light 316

3-4. Using the storage features

- List of storage features..... 317
- Glove boxes 318
- Coin holder..... 319
- Front console box 320
- Card holder 323
- Map holder 324
- Pen holder..... 326
- Tissue pocket..... 327
- Rear console box 328
- Overhead console 331
- Cup holders..... 333
- Bottle holders 337
- Auxiliary boxes..... 338

3-5. Using the other interior features

- Sun visors 340
- Vanity mirrors 341
- Clock 342
- Outside temperature display..... 343
- Portable ashtray 345
- Cigarette lighter..... 346
- Conversation mirror..... 347
- Power outlets 348
- Seat heaters..... 354
- Seat heaters and ventilators..... 357
- Armrests..... 359
- Rear side sunshades 360
- Assist grips..... 362
- Floor mat 363
- Luggage compartment features 365
- Garage door opener..... 370
- Compass 376

4 Maintenance and care

4-1. Maintenance and care

- Cleaning and protecting the vehicle exterior 382
- Cleaning and protecting the vehicle interior 385

4-2. Maintenance

- Maintenance requirements 388
- General maintenance 391
- Emission inspection and maintenance (I/M) programs..... 394

4-3. Do-it-yourself maintenance

- Do-it-yourself service precautions..... 395
- Hood 399
- Engine compartment 400
- Tires..... 415
- Tire inflation pressure 423
- Wheels..... 427
- Air conditioning filter 430
- Wireless remote control battery 433
- Checking and replacing fuses..... 435
- Light bulbs 447

5 When trouble arises

5-1. Essential information

Emergency flashers	460
If your vehicle needs to be towed	461
If you think something is wrong	467
Fuel pump shut off system	468

5-2. Steps to take in an emergency

If a warning light turns on or a warning buzzer sounds... ..	469
If a warning message is displayed (vehicles with multi-information display)	480
If you have a flat tire.....	486
If the engine will not start	497
If the shift lever cannot be shifted from P.....	499
If you lose your keys	500
If the vehicle battery is discharged	501
If your vehicle overheats	504
If the vehicle becomes stuck	507
If your vehicle has to be stopped in an emergency	509

6 Vehicle specifications

6-1. Specifications

Maintenance data (fuel, oil level, etc.)	512
Fuel information.....	523
Tire information	528

6-2. Customization

Customizable features.....	539
Items to initialize.....	543

7 For owners

Reporting safety defects for U.S. owners	546
Seat belt instructions for Canadian owners (in French).....	547
SRS airbag instructions for Canadian owners (in French).....	550

Index

Abbreviation list.....	560
Alphabetical index	562
What to do if... ..	573

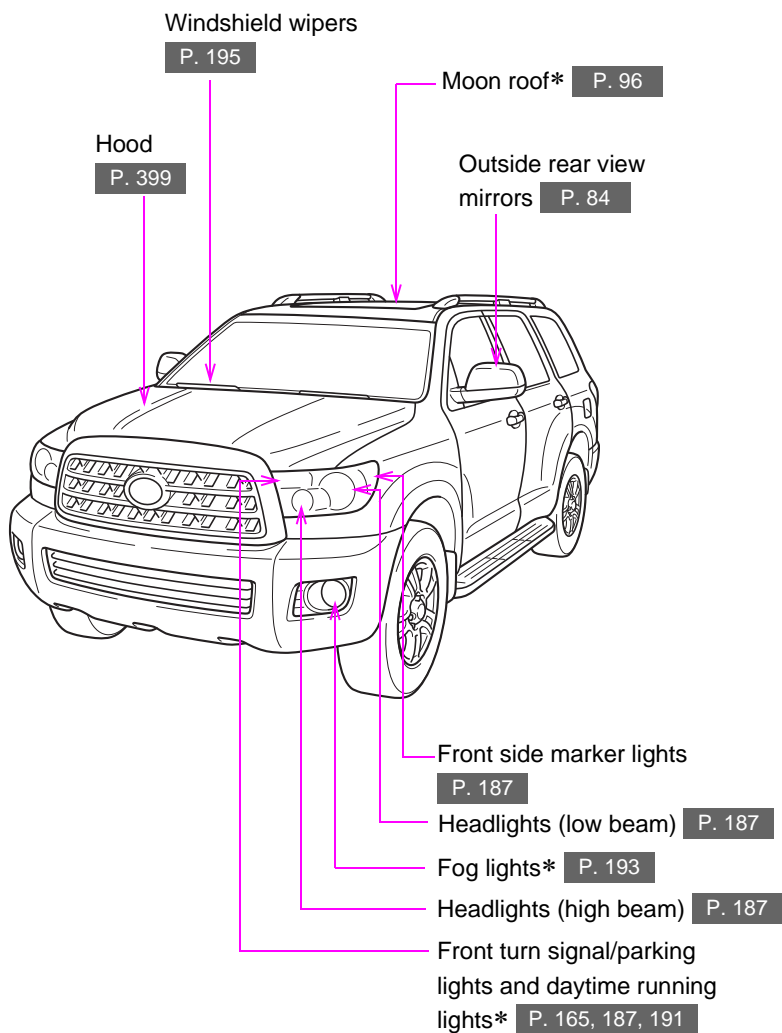

Stop/tail and rear side
marker lights **P. 187**

Roof luggage
carrier **P. 88**

Fuel filler door **P. 100**

Side doors
P. 35

Tail lights **P. 187**

Rear window defogger
P. 307

Back window
P. 93

Rear window
wiper **P. 199**

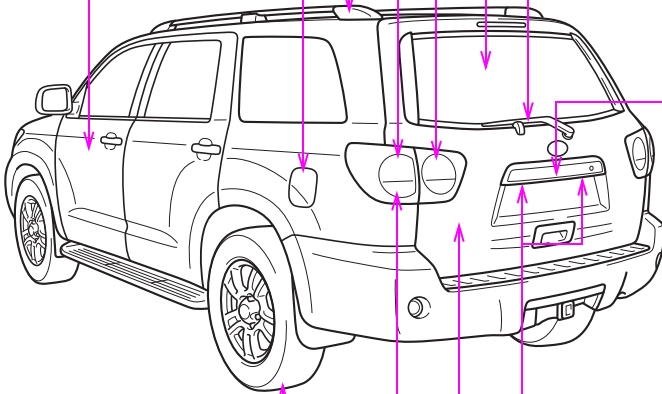

Camera*

Tires

- Rotation **P. 416**
- Replacement **P. 486**
- Inflation pressure **P. 423**
- Information **P. 528**

License plate
lights **P. 187**

Back door **P. 40**

Rear turn signal
lights **P. 165**

*: If equipped

*: Refer to "NAVIGATION SYSTEM OWNER'S MANUAL".

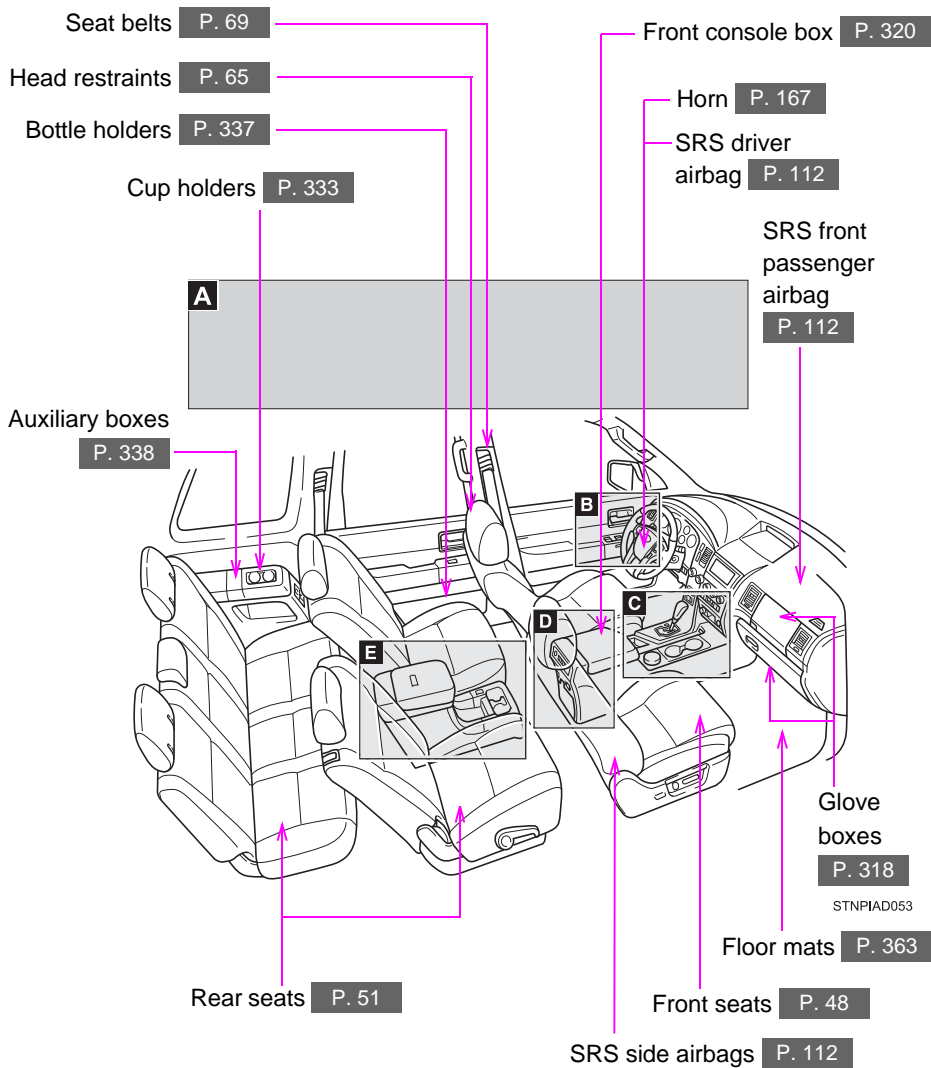

A**► Type A**

Personal/interior lights **P. 315**

Rear seat entertainment system**

SRS curtain shield airbags **P. 112**

Personal/interior lights **P. 315**

Personal/interior lights **P. 315**

Moon roof switches* **P. 96**

Overhead console **P. 331**

Conversation mirror **P. 347**

Assist grips **P. 362**

Vanity mirrors **P. 341**

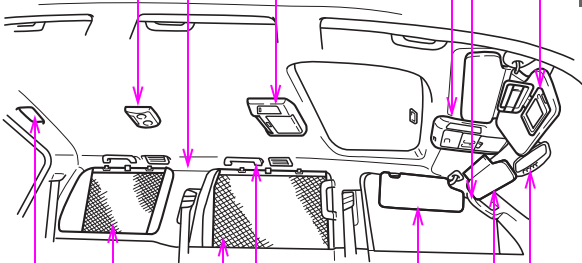

Interior light **P. 316**

Sun visors **P. 340**

Assist grips **P. 362**

Rear side sunshades* **P. 360**

STNPIAD051

Anti-glare inside rear view mirror **P. 81**

Compass* **P. 376**

Garage door opener switches* **P. 370**

*: If equipped

*: Refer to "NAVIGATION SYSTEM OWNER'S MANUAL".

A

► **Type B**

Personal/interior lights

P. 315

Rear seat entertainment system**

SRS curtain shield

airbags P. 112

Personal/interior lights P. 315

Personal/interior lights P. 315

Overhead console P. 331

Conversation mirror P. 347

Assist grips P. 362

Vanity mirrors P. 341

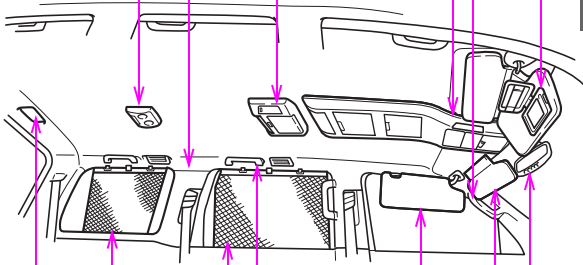

STNPIAD052

Interior light P. 316

Sun visors P. 340

Anti-glare inside rear view mirror P. 81

Compass* P. 376

Garage door opener switches* P. 370

Assist grips P. 362

Rear side sunshades* P. 360

B

Inside door lock
button P. 36

Door lock switch
P. 35

Driving position memory
switches* P. 62

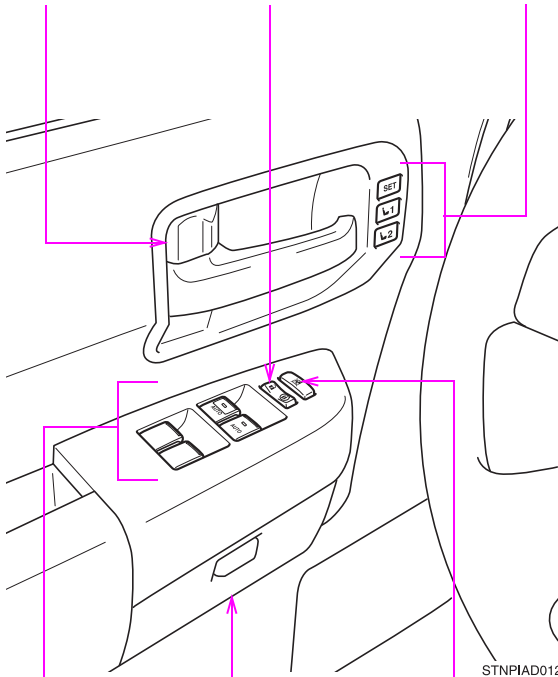

Power window
switches P. 90

Auxiliary box
P. 338

Window lock
switch P. 90

*: If equipped

*: Refer to "NAVIGATION SYSTEM OWNER'S MANUAL".

C

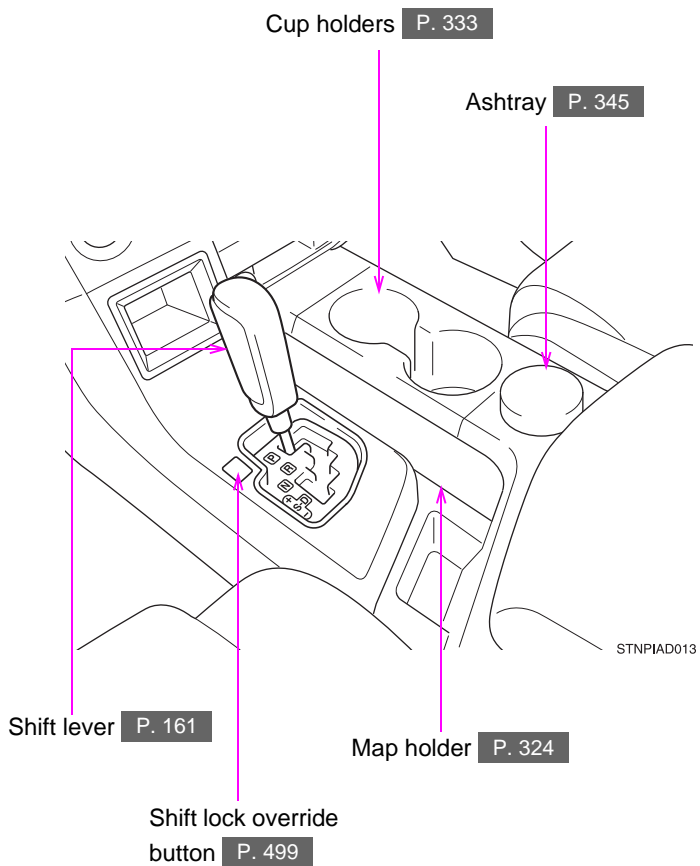

D

► **Vehicles without rear seat entertainment system**

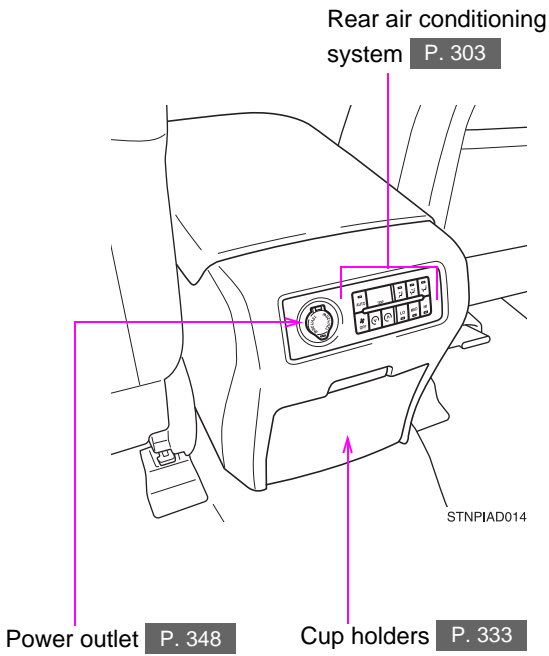

D

► Vehicles with rear seat entertainment system

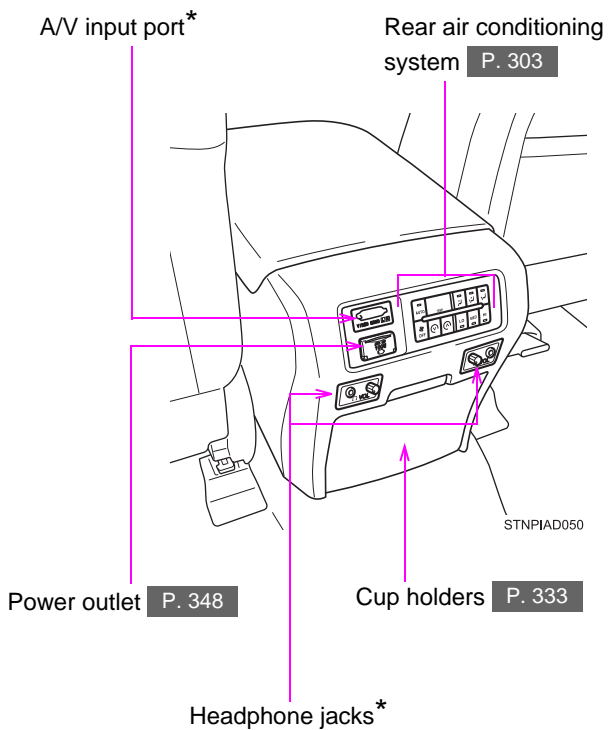

E

► Vehicles with rear console box

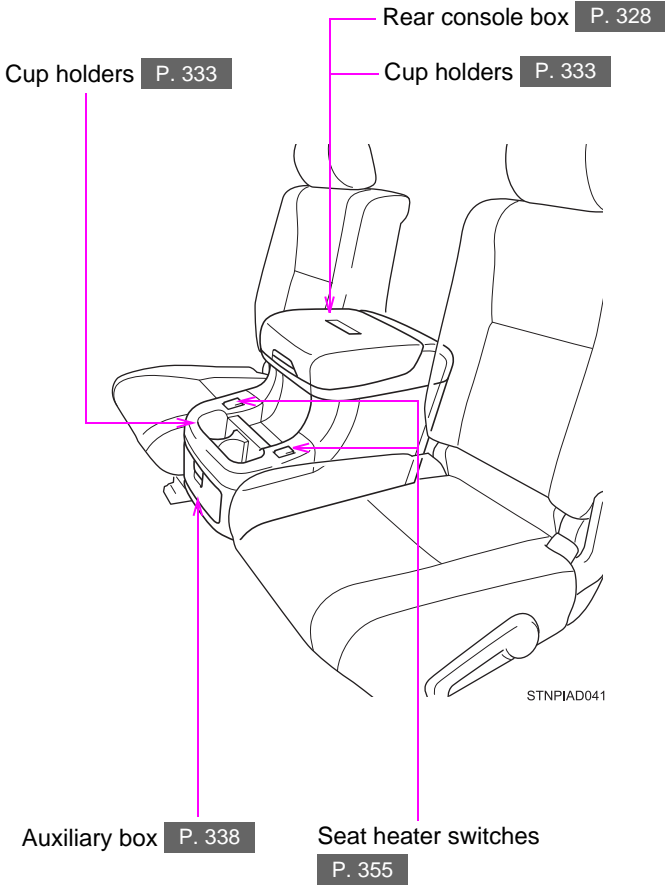

*: Refer to "NAVIGATION SYSTEM OWNER'S MANUAL".

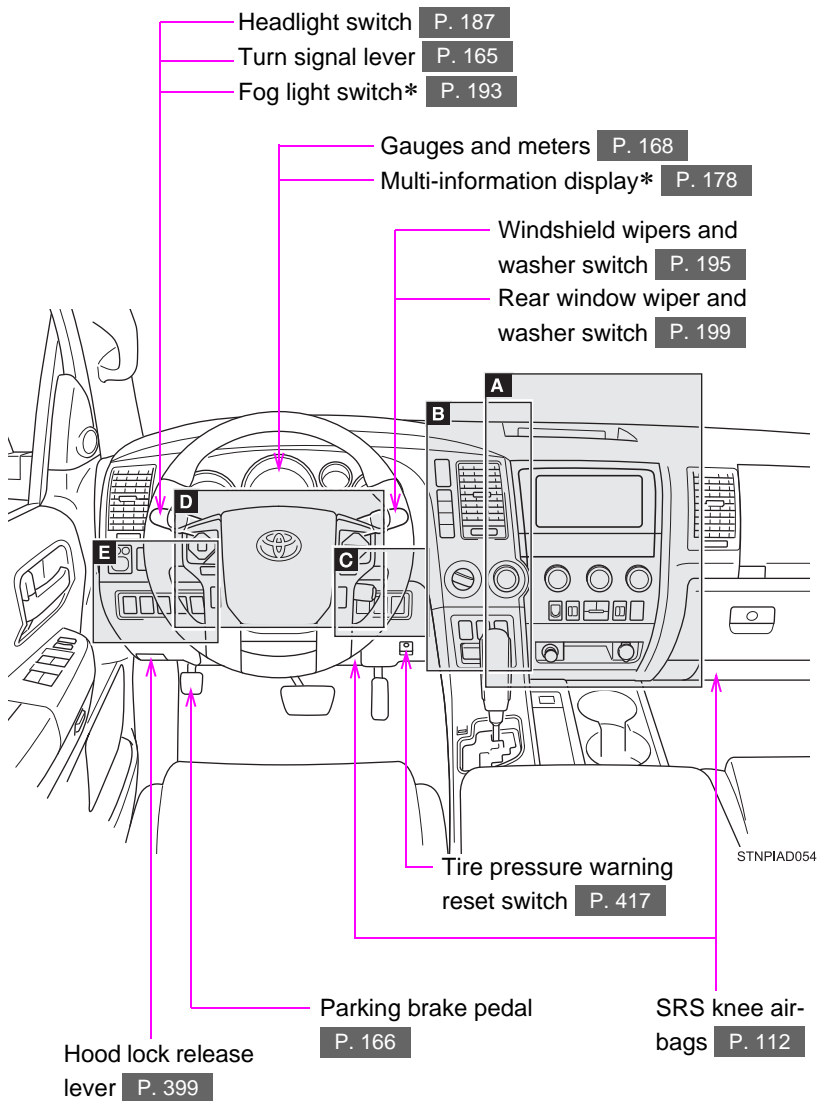

A

Rear window defogger switch/
 Rear window defogger and outside rear
 view mirror defogger switch* P. 307
 Windshield wiper de-icer* P. 309

Multimedia system* P. 310
 Rear view monitor system*

Accessory meter P. 184
 Security indicator P. 105, 107

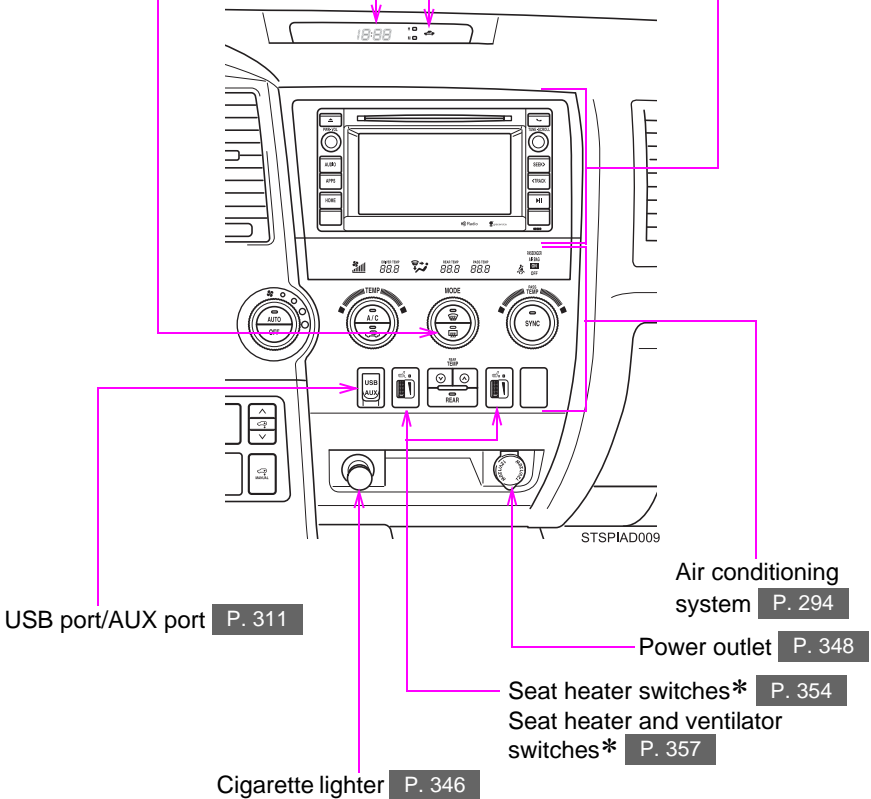

*: If equipped

*: Refer to "NAVIGATION SYSTEM OWNER'S MANUAL".

B

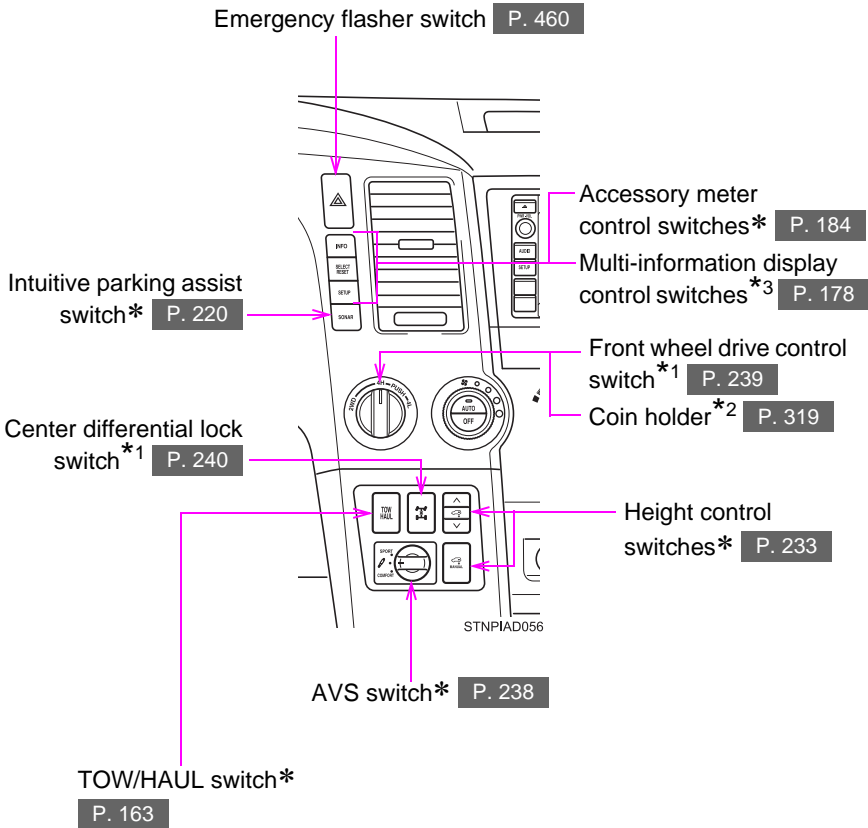

C

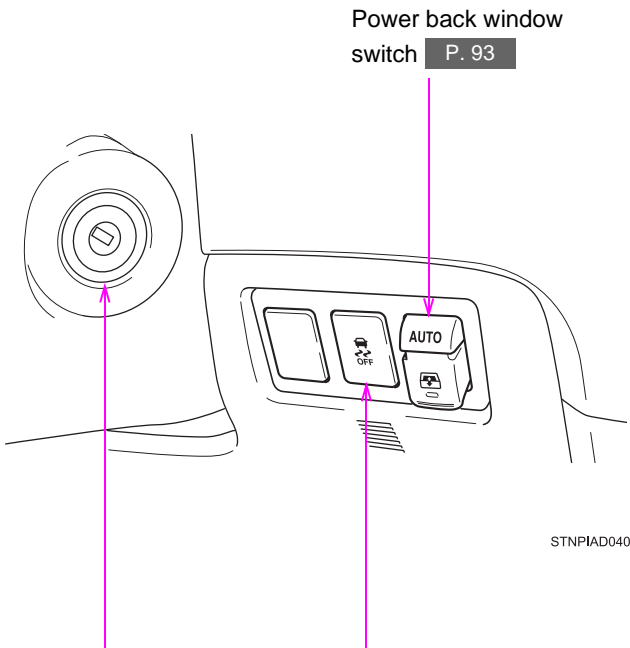

STNPIAD040

Engine (ignition) switch
P. 158

VSC OFF switch P. 244, 247, 249, 250

*: If equipped

*1: 4WD models

*2: 2WD models

*3: Vehicles with multi-information display

D

Audio remote control switches*

Talk switch**

Telephone switches**

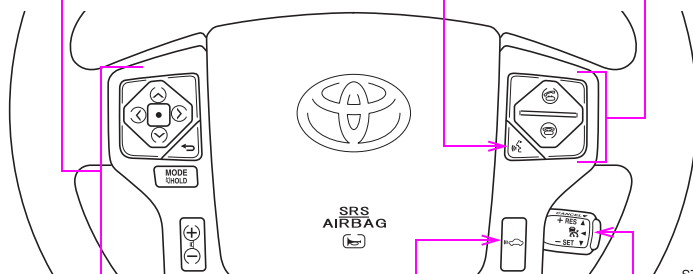

STNPIAD057

Vehicle-to-vehicle
distance button*

P. 206

Cruise control
switch

P. 202, 206

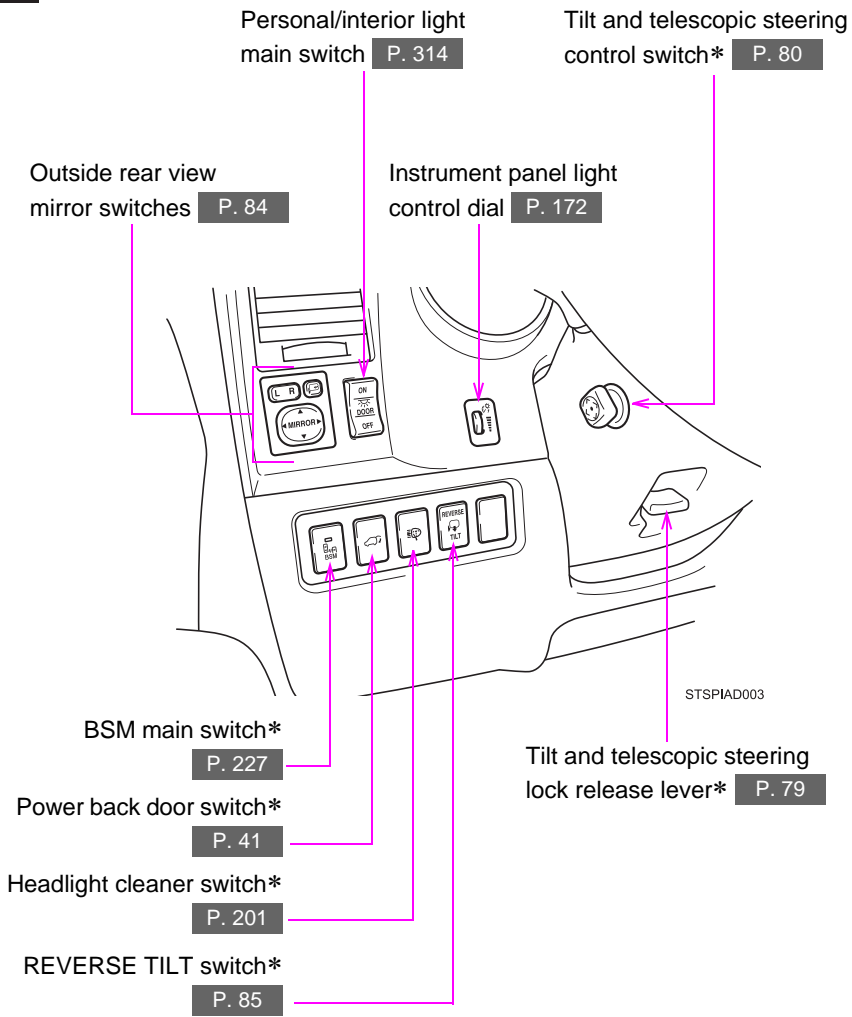
E

*: If equipped

*: Refer to "NAVIGATION SYSTEM OWNER'S MANUAL".

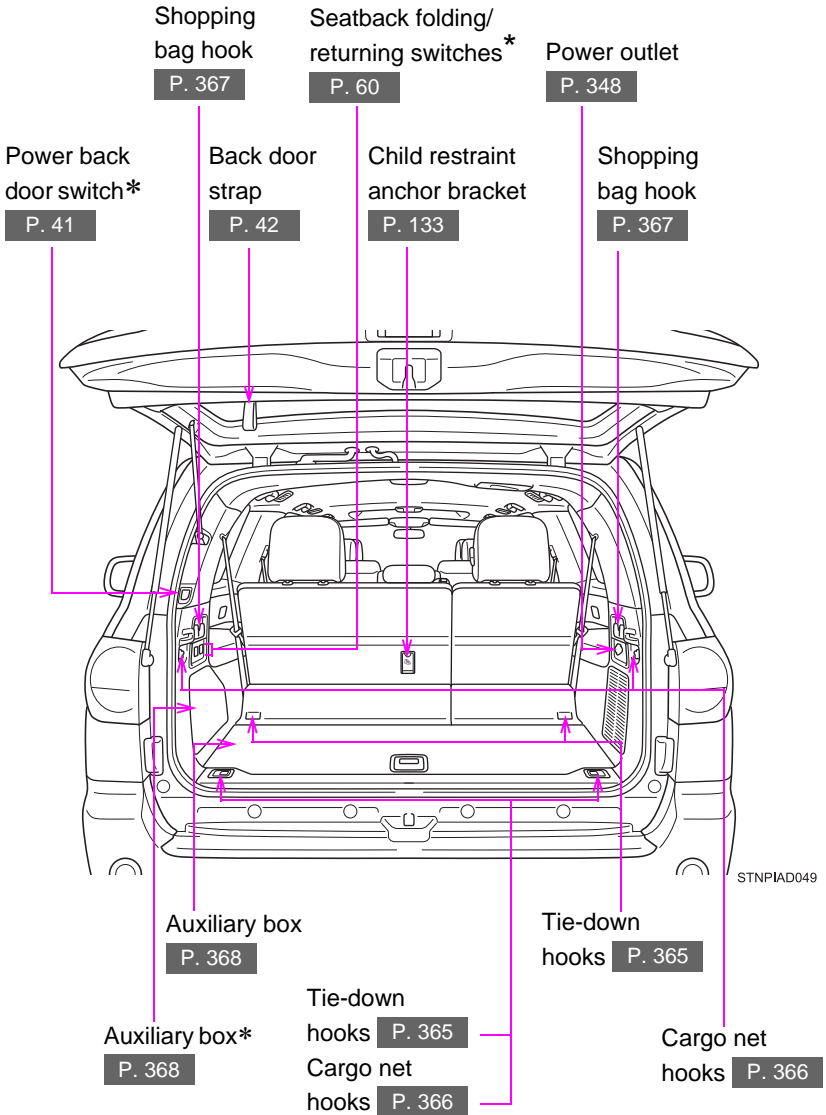

*: If equipped

*: Vehicles with third power seats

For your information

Main Owners Manual

Please note that this manual applies to all models and explains all equipment, including options. Therefore, you may find some explanations for equipment not installed on your vehicle.

All specifications provided in this manual are current at the time of printing. However, because of the Toyota policy of continual product improvement, we reserve the right to make changes at any time without notice.

Depending on specifications, the vehicle shown in the illustrations may differ from your vehicle in terms of equipment.

Noise from under vehicle after turning off the engine

Approximately five hours after the engine is turned off, you may hear sound coming from under the vehicle for several minutes. This is the sound of a fuel evaporation leakage check and, it does not indicate a malfunction.

Accessories, spare parts and modification of your Toyota

A wide variety of non-genuine spare parts and accessories for Toyota vehicles are currently available in the market. You should know that Toyota does not warrant these products and is not responsible for their performance, repair, or replacement, or for any damage they may cause to, or adverse effect they may have on, your Toyota vehicle.

This vehicle should not be modified with non-genuine Toyota products. Modification with non-genuine Toyota products could affect its performance, safety or durability, and may even violate governmental regulations. In addition, damage or performance problems resulting from the modification may not be covered under warranty.

Installation of a mobile two-way radio system

The installation of a mobile two-way radio system in your vehicle could affect electronic systems such as:

- Multiport fuel injection system/sequential multiport fuel injection system
- Cruise control system
- Anti-lock brake system
- SRS airbag system
- Seat belt pretensioner system

Be sure to check with your Toyota dealer for precautionary measures or special instructions regarding installation of a mobile two-way radio system.

Vehicle data recordings

Your Toyota is equipped with several sophisticated computers that will record certain data, such as:

- Engine speed
- Accelerator status
- Brake status
- Vehicle speed
- Shift position

The recorded data varies according to the vehicle grade level and options with which it is equipped. Furthermore, these computers do not record conversations, sounds or pictures.

● Data usage

Toyota may use the data recorded in these computers to diagnose malfunctions, conduct research and development, and improve quality.

Toyota will not disclose the recorded data to a third party except:

- With the consent of the vehicle owner or with the consent of the lessee if the vehicle is leased
- In response to an official request by the police, a court of law or a government agency
- For use by Toyota in a lawsuit
- For research purposes where the data is not tied to a specific vehicle or vehicle owner

Event data recorder

This vehicle is equipped with an event data recorder (EDR). The main purpose of an EDR is to record, in certain crash or near crash-like situations, such as an air bag deployment or hitting a road obstacle, data that will assist in understanding how a vehicle's systems performed. The EDR is designed to record data related to vehicle dynamics and safety systems for a short period of time, typically 30 seconds or less.

The EDR in this vehicle is designed to record such data as:

- How various systems in your vehicle were operating;
- Whether or not the driver and passenger safety belts were buckled/fastened;
- How far (if at all) the driver was depressing the accelerator and/or brake pedal; and,
- How fast the vehicle was traveling.

These data can help provide a better understanding of the circumstances in which crashes and injuries occur.

NOTE: EDR data are recorded by your vehicle only if a non-trivial crash situation occurs; no data are recorded by the EDR under normal driving conditions and no personal data (e.g., name, gender, age, and crash location) are recorded. However, other parties, such as law enforcement, could combine the EDR data with the type of personally identifying data routinely acquired during a crash investigation.

To read data recorded by an EDR, special equipment is required, and access to the vehicle or the EDR is needed. In addition to the vehicle manufacturer, other parties, such as law enforcement, that have the special equipment, can read the information if they have access to the vehicle or the EDR.

● Disclosure of the EDR data

Toyota will not disclose the data recorded in an EDR to a third party except when:

- An agreement from the vehicle's owner (or the lessee for a leased vehicle) is obtained
- In response to an official request by the police, a court of law or a government agency
- For use by Toyota in a lawsuit

However, if necessary, Toyota may:

- Use the data for research on vehicle safety performance
- Disclose the data to a third party for research purposes without disclosing information about the specific vehicle or vehicle owner

Scrapping of your Toyota

The SRS airbag and seat belt pretensioner devices in your Toyota contain explosive chemicals. If the vehicle is scrapped with the airbags and seat belt pretensioners left as they are, this may cause an accident such as fire. Be sure to have the systems of the SRS airbag and seat belt pretensioner removed and disposed of by a qualified service shop or by your Toyota dealer before you scrap your vehicle.

Perchlorate Material

Special handling may apply,
See www.dtsc.ca.gov/hazardouswaste/perchlorate.

Your vehicle has components that may contain perchlorate. These components may include airbag, seat belt pretensioners, and wireless remote control batteries.

 **CAUTION**

■ **General precautions while driving**

Driving under the influence: Never drive your vehicle when under the influence of alcohol or drugs that have impaired your ability to operate your vehicle. Alcohol and certain drugs delay reaction time, impair judgment and reduce coordination, which could lead to an accident that could result in death or serious injury.

Defensive driving: Always drive defensively. Anticipate mistakes that other drivers or pedestrians might make and be ready to avoid accidents.

Driver distraction: Always give your full attention to driving. Anything that distracts the driver, such as adjusting controls, talking on a cellular phone or reading can result in a collision with resulting death or serious injury to you, your occupants or others.

■ **General precaution regarding children's safety**

Never leave children unattended in the vehicle, and never allow children to have or use the key.

Children may be able to start the vehicle or shift the vehicle into neutral. There is also a danger that children may injure themselves by playing with the cigarette lighter, the windows, the moon roof, or other features of the vehicle. In addition, heat build-up or extremely cold temperatures inside the vehicle can be fatal to children.

Symbols used throughout this manual

Cautions & Notices

⚠ CAUTION

This is a warning against anything which may cause injury to people if the warning is ignored. You are informed about what you must or must not do in order to reduce the risk of injury to yourself and others.

⚠ NOTICE

This is a warning against anything which may cause damage to the vehicle or its equipment if the warning is ignored. You are informed about what you must or must not do in order to avoid or reduce the risk of damage to your Toyota and its equipment.

Symbols used in illustrations



Safety symbol

The symbol of a circle with a slash through it means “Do not”, “Do not do this”, or “Do not let this happen”.

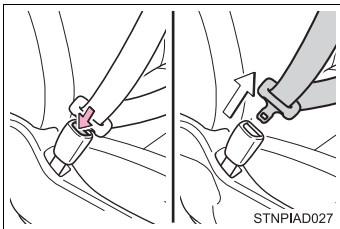

Arrows indicating operations

- ➔ Indicates the action (pushing, turning, etc.) used to operate switches and other devices.
- ⇨ Indicates the outcome of an operation (e.g. a lid opens).

Before driving

1

- 1-1. Key information**
 - Keys 30
- 1-2. Opening, closing and locking the doors**
 - Wireless remote control 31
 - Side doors 35
 - Back door 40
- 1-3. Adjustable components (seats, mirrors, steering wheel)**
 - Front seats 48
 - Rear seats 51
 - Driving position memory (driver's seat) 62
 - Head restraints 65
 - Seat belts 69
 - Steering wheel (manually adjustable type) 79
 - Steering wheel (power-adjustable type) ... 80
 - Anti-glare inside rear view mirror 81
 - Outside rear view mirrors... 84
 - Roof luggage carrier 88
- 1-4. Opening and closing the windows and moon roof**
 - Power windows 90
 - Power back window 93
 - Moon roof 96
- 1-5. Refueling**
 - Opening the fuel tank cap 100
- 1-6. Theft deterrent system**
 - Engine immobilizer system 105
 - Alarm 107
- 1-7. Safety information**
 - Correct driving posture..... 110
 - SRS airbags 112
 - Front passenger occupant classification system 124
 - Child restraint systems..... 129
 - Installing child restraints... 133

The following keys are provided with the vehicle.

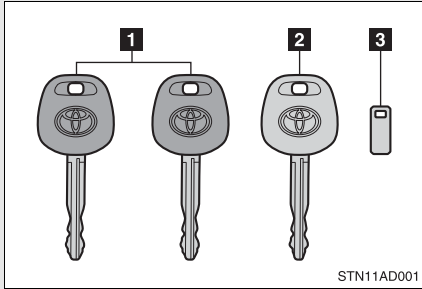

- 1 Master keys
- 2 Valet key
- 3 Key number plate

■ When required to leave a key to the vehicle with a parking attendant

Lock the glove box as circumstances demand. (→P. 318)

Carry the master key for your own use and leave the valet key only with the attendant.

■ Key number plate

Keep the plate in a safe place such as your wallet, not in the vehicle. In the event that a key is lost, a new key can be made by your Toyota dealer using the key number plate. (→P. 500)

⚠ NOTICE

■ To prevent key damage

- Do not subject the keys to strong shocks, expose them to high temperatures by placing them in direct sunlight, or get them wet.
- Do not expose the keys to electromagnetic materials or attach any material that blocks electromagnetic waves to the key surface.

1-2. Opening, closing and locking the doors

Wireless remote control

The wireless remote control can be used to lock and unlock the vehicle from outside the vehicle.

► Vehicles with power back door

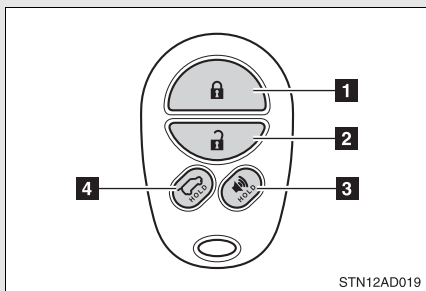

1 Locks all doors

Check that the door is securely locked.

2 Unlocks all doors

Pressing the button unlocks the driver's door. Pressing the button again within 3 seconds unlocks the other doors.

3 Pushing and holding: Sounds alarm

4 Pushing and holding: Opens and closes the power back door

► Vehicles without power back door

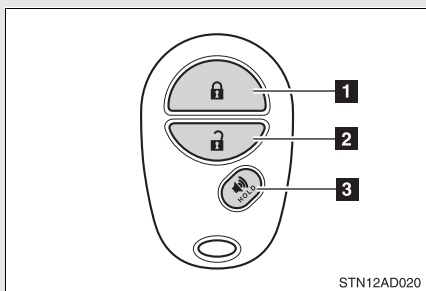

1 Locks all doors

Check that the door is securely locked.

2 Unlocks all doors

Pressing the button unlocks the driver's door. Pressing the button again within 3 seconds unlocks the other doors.

3 Pushing and holding: Sounds alarm

■ Operation signals

Doors: A buzzer sounds and the emergency flashers flash to indicate that the doors have been locked/unlocked. (Locked: Once; Unlocked: Twice)

Back door: A buzzer sounds and the emergency flashers flash twice to indicate that the back door has been opened/closed.

■ Panic mode

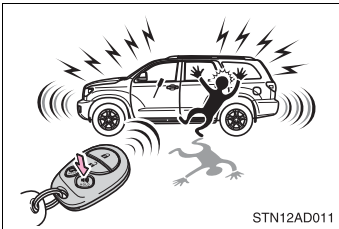

When  is pushed for longer than about one second, an alarm will sound for about 60 seconds and the vehicle lights will flash to deter any person from trying to break into or damage your vehicle.

To stop the alarm, push any button on the wireless remote control.

■ Door lock buzzer

If a door is not fully closed, a buzzer sounds continuously if an attempt to lock the door is made. Fully close the door to stop the buzzer, and lock the vehicle once more.

■ Power back door operation (vehicles with power back door)

The power back door can be opened even if it is locked. Lock the back door again when you leave the vehicle. The back door will not lock automatically after it has been opened and then closed.

■ Wireless remote control battery depletion

The standard battery life is 1 to 2 years. (The battery becomes depleted even if the wireless remote control is not used.) If the wireless remote control function does not operate, the battery may be depleted. Replace the battery when necessary. (→P. 433)

■ If the wireless remote control does not operate

Locking and unlocking the doors: Use the key. (→P. 35)

■ Security feature

If a door is not opened within approximately 60 seconds after the vehicle is unlocked, the security feature automatically locks the vehicle again.

■ Alarm

Using the wireless remote control to lock the door will set the alarm system. (→P. 107)

■ Conditions affecting operation

The wireless remote control function may not operate normally in the following situations.

- Near a TV tower, radio station, electric power plant, airport or other facility that generates strong radio waves
- When carrying a portable radio, cellular phone or other wireless communication device
- When multiple wireless keys are in the vicinity
- When the wireless key has come into contact with, or is covered by a metallic object
- When a wireless key (that emits radio waves) is being used nearby
- When the wireless key has been left near an electrical appliance such as a personal computer

■ When riding in an aircraft

When bringing a wireless remote control onto an aircraft, make sure you do not press any buttons on the wireless remote control while inside the aircraft cabin. If you are carrying a wireless remote control in your bag etc., ensure that the buttons are not likely to be pressed accidentally. Pressing a button may cause the wireless remote control to emit radio waves that could interfere with the operation of the aircraft.

■ Customization

- That can be configured at Toyota dealer (vehicles without multi-information display)

Settings (e.g. wireless remote control) can be changed.
(Customizable features →P. 539)

- It is possible to change the settings (vehicles with multi-information display) (Feature customization →P. 181)

■ **Certification for wireless remote control**

MODEL/FCC IDs:

Transmitter: GQ43VT20T

Receiver: GQ4-34R

IC (Canada) IDs:

Transmitter: 1470A-1T

Receiver: 1470A-6R

MADE IN USA

This device complies with Part 15 of the FCC Rules and with RSS-210 of Industry Canada.

Operation is subject to the following two conditions: (1) This device may not cause harmful interference, and (2) This device must accept any interference received, including interference that may cause undesired operation.

WARNING: Changes or modifications not expressly approved by the party responsible for compliance could void the user's authority to operate the equipment.

1-2. Opening, closing and locking the doors

Side doors

The vehicle can be locked and unlocked using the wireless remote control, key or door lock switch.

■ Wireless remote control

→P. 31

■ Key

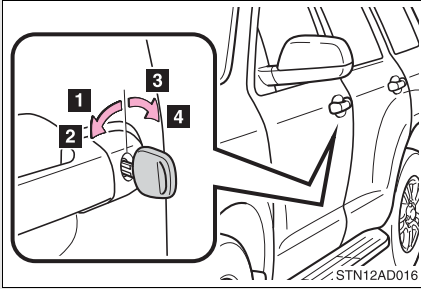

- 1** Locks all doors
- 2** Closes the windows and moon roof (turn and hold)
- 3** Unlocks all doors

Turning the key unlocks the driver's door. Turning the key again unlocks the other doors.

- 4** Opens the front windows and moon roof (turn and hold)

■ Door lock switch

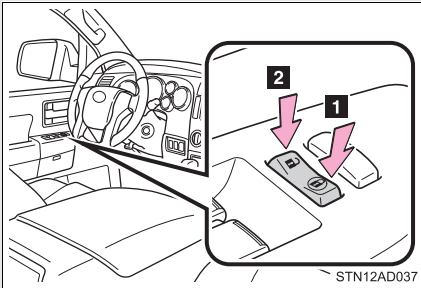

- 1** Locks all doors
- 2** Unlocks all doors

■ Inside door lock button

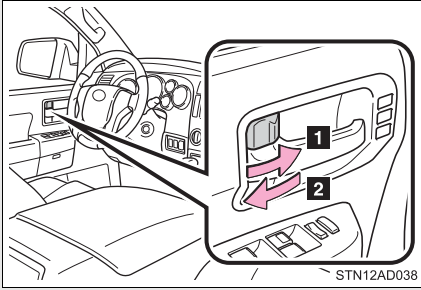

1 Locks the door

2 Unlocks the door

Pulling the door handle can open the front door even if the inside door lock button is in the lock position.

Locking the front doors from the outside without a key

STEP 1 Move the inside door lock button to the lock position.

STEP 2 Close the door.

The door cannot be locked if a front door is open and the key is in the engine switch.

Rear door child-protector lock

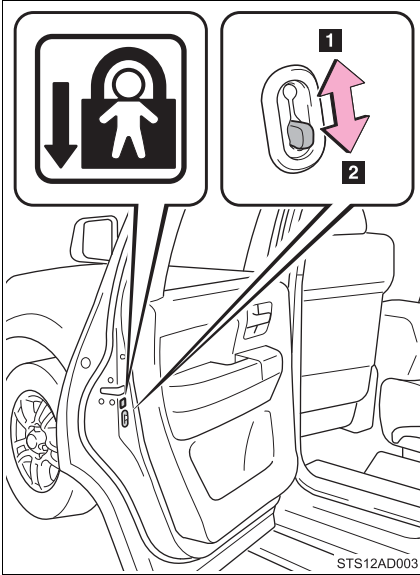

The door cannot be opened from inside the vehicle when the lock is set.

1 Unlock

2 Lock

These locks can be set to prevent children from opening the rear doors. Push down on each rear door switch to lock both rear doors.

1

Before driving

Automatic door locking and unlocking systems

The following functions can be set or canceled:

Function	Operation
Shift position linked door locking function	Shifting the shift lever out of P locks all doors.
Shift position linked door unlocking function	Shifting the shift lever to P unlocks all doors.
Speed linked door locking function	All doors are locked when the vehicle speed is approximately 12 mph (20 km/h) or higher.
Driver's door linked door unlocking function	All doors are unlocked when the driver's door is opened within 10 seconds after turning the engine switch to the ACC or LOCK position.

■ Setting and canceling the functions

- ▶ Vehicles with multi-information display

→P. 181

- ▶ Vehicles without multi-information display

To switch between setting and canceling, follow the procedure below:

STEP 1 Close all the doors and turn the engine switch to the ON position. (Perform step 2 within 20 seconds.)

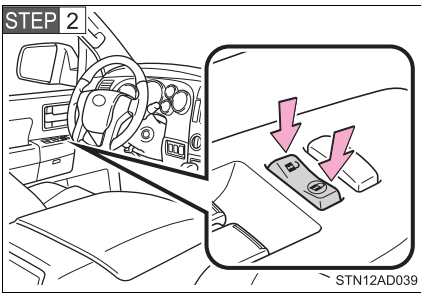

Shift the shift lever to P or N, press and hold the driver's door lock switch (🔒 or 🔓) for approximately 5 seconds and then release.

The shift lever and switch positions corresponding to the desired function to be set are shown as follows.

Use the same procedure to cancel the function.

Function	Shift lever position	Driver's door lock switch position
Shift position linked door locking function	P	🔒
Shift position linked door unlocking function		🔓
Speed linked door locking function	N	🔒
Driver's door linked door unlocking function		🔓

When the setting or canceling operation is complete, all doors are locked and then unlocked.

■ When locking the doors using the key

The door cannot be locked if the key is in the engine switch.

■ Key reminder buzzer

A buzzer sounds if the driver's door is opened, while the engine switch is in the ACC or LOCK position to remind you to remove the key.

▲ CAUTION**■ To prevent an accident**

Observe the following precautions while driving the vehicle.

Failing to do so may result in a door opening and an occupant falling out, resulting in death or serious injury.

- Always use a seat belt.
- Always lock the doors.
- Ensure that all doors are properly closed.
- Do not pull the inside handle of the doors while driving.
The doors may be opened and the passengers are thrown out of the vehicle and it may result in serious injury or death.
Be especially careful for the front doors, as the doors may be opened even if the inside door lock buttons are in locked position.
- Set the rear door child protector locks when children are seated in the rear seats.

1-2. Opening, closing and locking the doors

Back door

The back door can be locked/unlocked and opened by the following procedures.

■ Locking and unlocking the back door

▶ Key

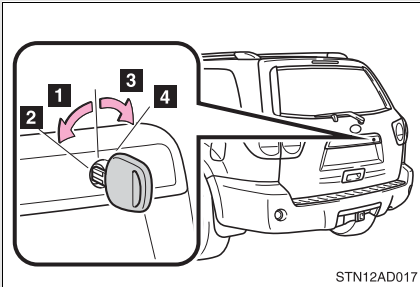

- 1 Unlocks all doors
- 2 Opens the back window (turn and hold)
- 3 Locks all doors
- 4 Closes the back window (turn and hold)

▶ Door lock switches

→P. 35

▶ Wireless remote control

→P. 31

■ Opening the back door from outside the vehicle

▶ Back door opener

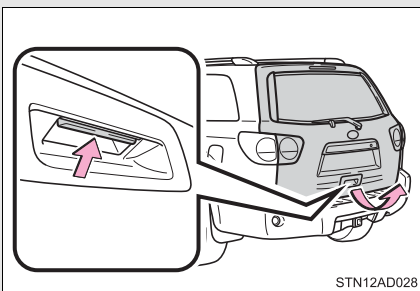

Raise the back door while pushing up the back door opener switch.

▶ Wireless remote control (vehicles with power back door)

→P. 31

■ Opening the back door from inside the vehicle (vehicles with power back door)

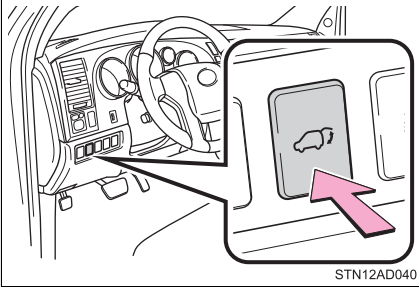

Push and hold the switch to open/close.

Power back door switch (vehicles with power back door)

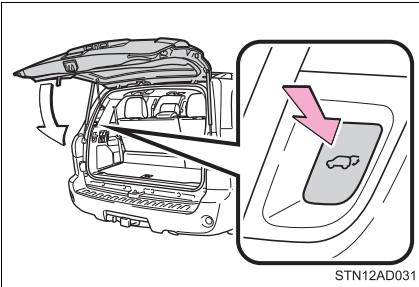

Push and hold the switch to close.

When the back door is not completely opened, the power back door may not close by the switch.

A buzzer sounds and the emergency flashers flash twice to indicate that the back door has been opened/closed.

The back door can be opened even if it is locked. Lock the back door again when you leave the vehicle. The back door will not lock automatically after it has been opened and then closed.

Rear step bumper

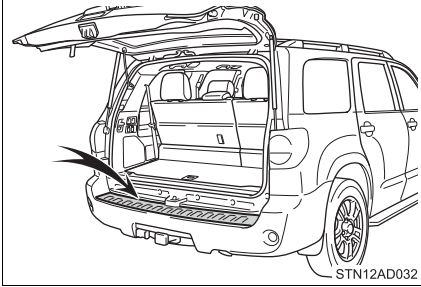

For rear end protection and easier step-up loading.

To get on the rear step bumper, use the shaded area in the illustration.

■ Back door strap

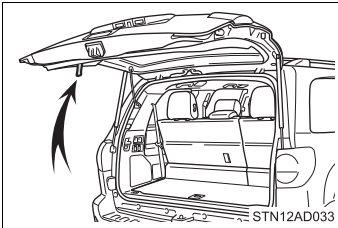

Use the strap when closing.

■ The power back door can be opened when

- The engine switch is in the ON position, and the shift lever is in P.
- The engine switch is in the ACC or LOCK position.

■ Jam protection function (vehicles with power back door)

If anything obstructs the power back door while it is closing/opening, the back door will automatically operate in the opposite direction.

■ If the power back door does not work

The back door must be initialized. To initialize, close the back door completely by hand and unlock the back door.

■ Back door closer (vehicles with power back door)

In the event that the back door is left slightly open, the back door closer will automatically close it to the fully closed position.

■ Fall-down protection function (vehicles with power back door)

While the power back door is opening automatically, applying excessive force to it will stop the opening operation to prevent the power back door from rapidly falling down.

■ Customization that can be configured at Toyota dealer

Settings (e.g. power back door) can be changed.
(Customizable features →P. 539)

CAUTION

■ Caution while driving

- Keep the back door closed while driving.
If the back door is left open, it may hit near-by objects while driving or luggage may be unexpectedly thrown out, causing an accident.
In addition, exhaust gases may enter the vehicle, causing death or a serious health hazard. Make sure to close the back door before driving.
- Before driving the vehicle, make sure that the back door is fully closed. If the back door is not fully closed, it may open unexpectedly while driving, causing an accident.
- Never let anyone sit in the luggage compartment. In the event of sudden braking or a collision, they are susceptible to death or serious injury.

■ When children are in the vehicle

Observe the following precautions.

Failure to do so may result in death or serious injury.

- Do not allow children to play in the luggage compartment.
If a child is accidentally locked in the luggage compartment, they could have heat exhaustion or other injuries.
- Do not allow a child to open or close the back door.
Doing so may cause the back door to move unexpectedly, or cause the child's hands, head, or neck to be caught by the closing back door.

! CAUTION

■ Operating the back door

Observe the following precautions.

Failure to do so may cause parts of the body to be caught, resulting in death or serious injury.

- Remove any heavy loads, such as snow and ice, from the back door before opening it. Failure to do so may cause the back door to suddenly shut again after it is opened.
- When opening or closing the back door, thoroughly check to make sure the surrounding area is safe.
- If anyone is in the vicinity, make sure they are safe and let them know that the back door is about to open or close.
- Use caution when opening or closing the back door in windy weather as it may move abruptly in strong wind.

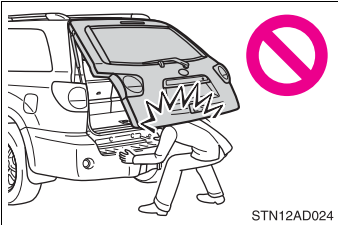

- The back door may suddenly shut if it is not opened fully. It is more difficult to open or close the back door on an incline than on a level surface, so beware of the back door unexpectedly opening or closing by itself. Make sure that the back door is fully open and secure before using the luggage compartment.

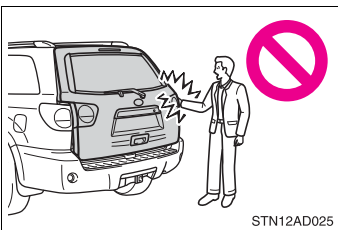

- When closing the back door, take extra care to prevent your fingers etc. from being caught.
- When closing the back door, make sure to press it lightly on its outer surface. If the back door strap is used to fully close the back door, it may result in hands or arms being caught.

- Do not pull on the back door damper stay to close the back door, and do not hang on the back door damper stay. Doing so may cause hands to be caught or the back door damper stay to break, causing an accident.

⚠ CAUTION

■ Operating the back door

- If a bicycle carrier or similar heavy object is attached to the back door, it may suddenly shut again after being opened, causing someone's hands, head or neck to be caught and injured. When installing an accessory part to the back door, using a genuine Toyota part is recommended.

■ Back door closer (vehicles with a power back door)

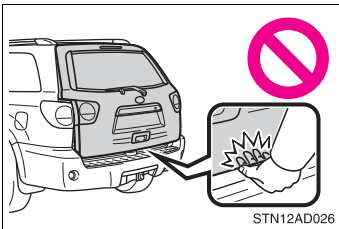

- In the event that the back door is left slightly open, the back door closer will automatically close it to the fully closed position. It takes several seconds before the back door closer begins to operate. Be careful not to catch fingers or anything else in the back door, as this may cause bone fractures or other serious injuries.

- Use caution when using the back door closer as it still operates when the power back door system is cancelled.

■ Power back door (if equipped)

Observe the following precautions when operating the power back door. Failure to do so may cause death or serious injury.

- Check the safety of the surrounding area to make sure there are no obstacles or anything that could cause any of your belongings to get caught.
- If anyone is in the vicinity, make sure they are safe and let them know that the back door is about to open or close.
- If the power back door system is turned off with the main switch while the back door is operating automatically, the automatic operation is stopped. The back door then has to be operated manually. Take extra care when on an incline, as the back door may open or close unexpectedly.
- If the operating conditions of the power back door are no longer met, a buzzer may sound and the back door may stop opening or closing. The back door then has to be operated manually. Take extra care when on an incline, as the back door may open or close abruptly.

 CAUTION

■ **Power back door (if equipped)**

- On an incline, the back door may suddenly shut after it opens. Make sure the back door is fully open and secure.
- In the following situations, the power back door may detect an abnormality and automatic operation may be stopped. In this case, the back door has to be operated manually. Take extra care when on an incline, as the back door may open or close abruptly.
 - When the back door contacts an obstacle
 - When the battery voltage suddenly drops, such as when the engine switch is turned to the ON position or the engine is started during automatic operation
- If a bicycle carrier or similar heavy object is attached to the back door, the power back door may not operate, causing itself to malfunction, or the back door may suddenly shut again after being opened, causing someone's hands, head or neck to be caught and injured. When installing an accessory part to the back door, using a genuine Toyota part is recommended.

■ **Jam protection function (vehicles with a power back door)**

Observe the following precautions.

Failure to do so may cause death or serious injury.

- Never use any part of your body to intentionally activate the jam protection function.
- The jam protection function may not work if something gets caught just before the back door fully closes. Be careful not to catch fingers or anything else.
- The jam protection function may not work depending on the shape of the object that is caught. Be careful not to catch fingers or anything else.

 NOTICE

■ Back door damper stays

The back door is equipped with damper stays that hold the back door in place.

Observe the following precautions.

Failure to do so may cause damage to the back door damper stay, resulting in malfunction.

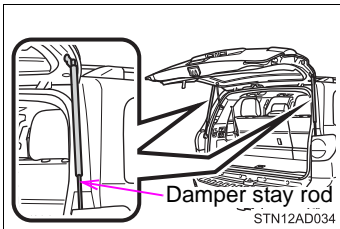

- Do not attach any foreign objects, such as stickers, plastic sheets, or adhesives to the damper stay rod.
- Do not touch the damper stay rod with gloves or other fabric items.
- Do not attach any accessories other than genuine Toyota parts to the back door.
- Do not place your hand on the damper stay or apply lateral forces to it.

■ To prevent back door closer malfunction (vehicles with a power back door)

Do not apply excessive force to the back door while the back door closer is operating.

■ To prevent damage to the power back door (if equipped)

- Make sure that there is no ice between the back door and frame that would prevent movement of the back door. Operating the power back door when excessive load is present on the back door may cause a malfunction.
- Do not apply excessive force to the back door while the power back door is operating.
- Take care not to damage the sensors (installed on the right and left edges of the power back door) with a knife or other sharp object. If the sensor is disconnected, the power back door will not operate in automatic operation.

Front seats

► Manual seat

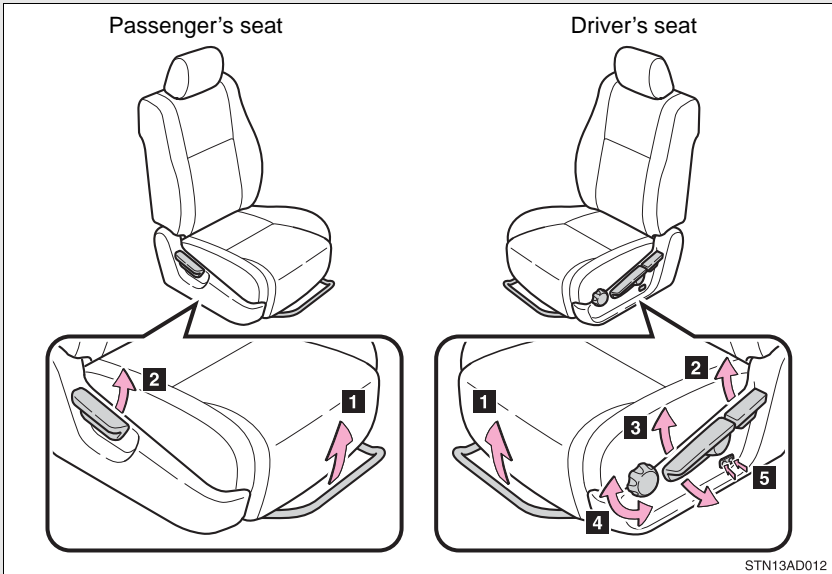

- 1** Seat position adjustment lever
- 2** Seatback angle adjustment lever
- 3** Vertical height adjustment lever
- 4** Seat cushion (front) angle adjustment knob
- 5** Seat lumbar support adjustment switch

► Power seat

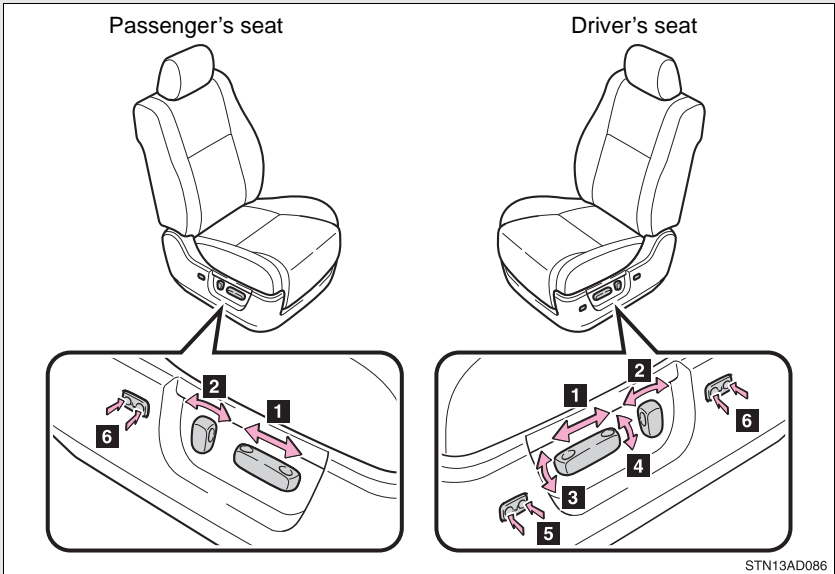

STN13AD086

- 1 Seat position adjustment switch
- 2 Seatback angle adjustment switch
- 3 Seat cushion (front) angle adjustment switch
- 4 Vertical height adjustment switch
- 5 Driver's seat leg support adjustment switch (if equipped)
- 6 Seat lumbar support adjustment switch

 CAUTION

■ **Seat adjustment**

- Be careful that the seat does not hit passengers or luggage.
- Do not recline the seat more than necessary when the vehicle is in motion to reduce the risk of sliding under the lap belt.
If the seat is too reclined, the lap belt may slide past the hips and apply restraint forces directly to the abdomen or your neck may contact the shoulder belt, increasing the risk of death or serious injury in the event of an accident.
- Manual seat only: After adjusting the seat, make sure that the seat is locked in position.

Rear seats

■ Second seats

▶ Separated seat

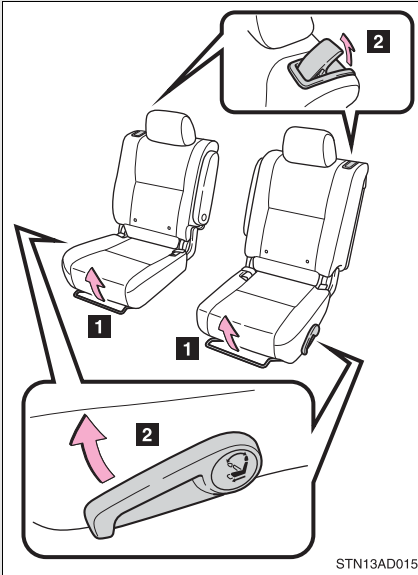

1 Seat position adjustment lever

2 Seatback angle adjustment lever

► Bench seat

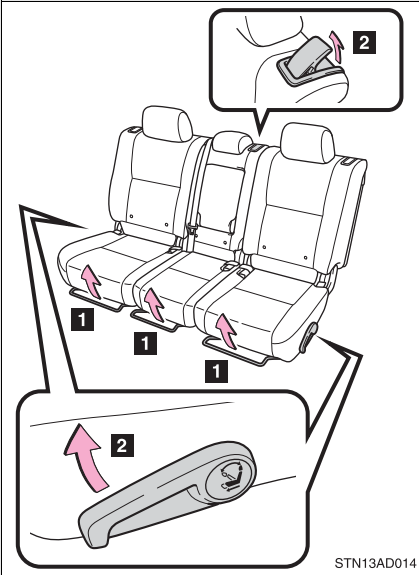

1 Seat position adjustment lever*

2 Seatback angle adjustment lever

*:The second center seat can be moved forward further than side seats.

■ **Third seats**

▶ **Manual seat**

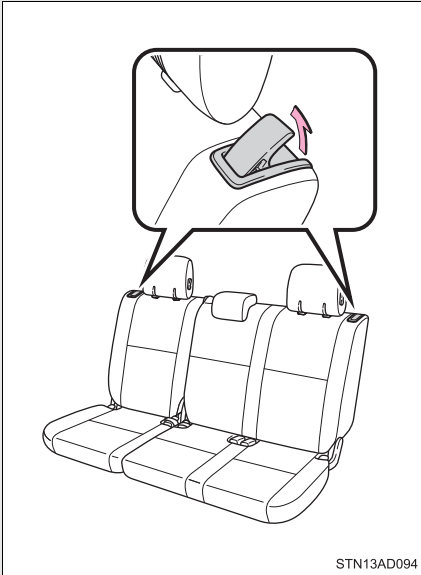

Seatback angle adjustment lever

► Power seat

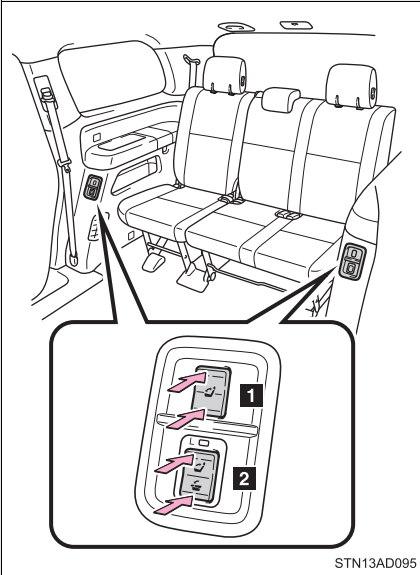

- 1 Seatback angle adjustment switch
- 2 Seatback folding/returning switch

Moving a second seat for third seat access

■ Getting in the vehicle

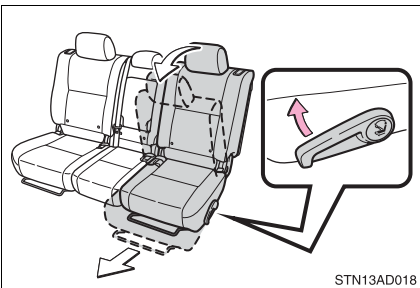

Pull up the lever and fold down the seatback. The seat will slide forward.

Move the seat to the front-most position

■ Getting out of the vehicle

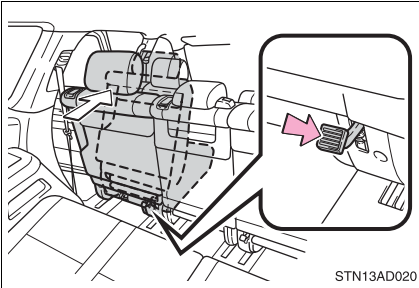

Depress the release pedal and fold down the seatback. The seat will slide forward.

Move the seat to the front-most position

Make sure that no passenger is seated on the second seat before depressing the release pedal.

■ After passengers have entered/exited the vehicle

Lift up the seatback and slide the seat backward until it locks.

Folding down the second seat

■ Before folding down the second seat

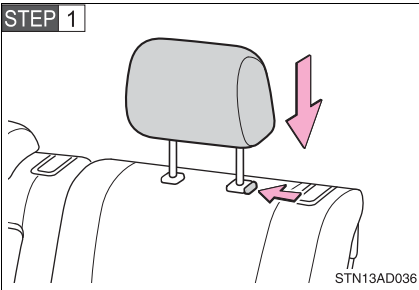

Adjust the head restraint to the downmost position.

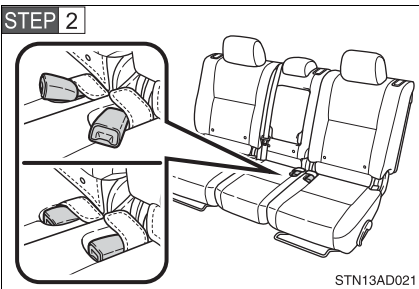

Stow the rear seat belt buckle.

■ **Folding down the second seat**

▶ **Separated seat**

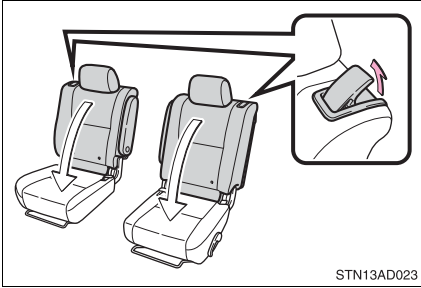

Pull the lever to unlock the seatback and then fold the seatback down.

▶ **Bench seat**

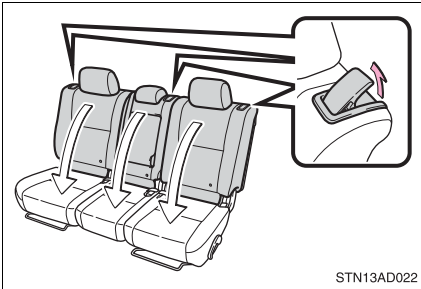

Pull the lever to unlock the seatback and then fold the seatback down.

■ **After folding down the second seat (if equipped)**

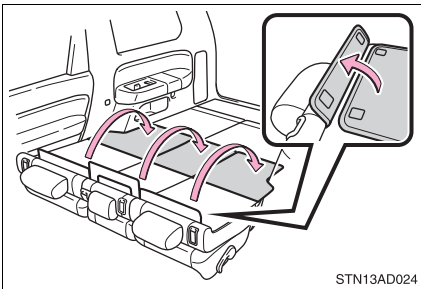

Fold out the board from the seatback.

Folding down the third seat

■ Before folding down the third seat

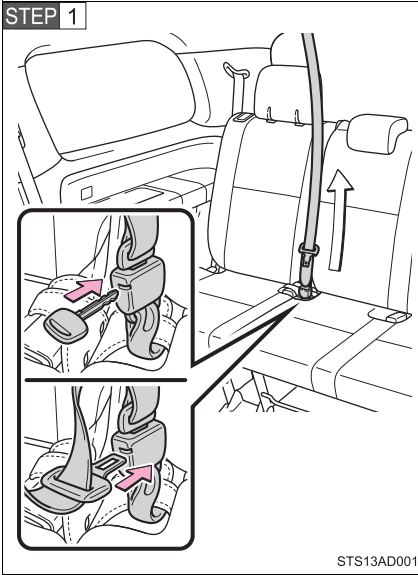

To release the hooked end tab, insert the key or concaved end tab into the hole on the buckle.

Retract the belt slowly when releasing and stowing the seat belt.

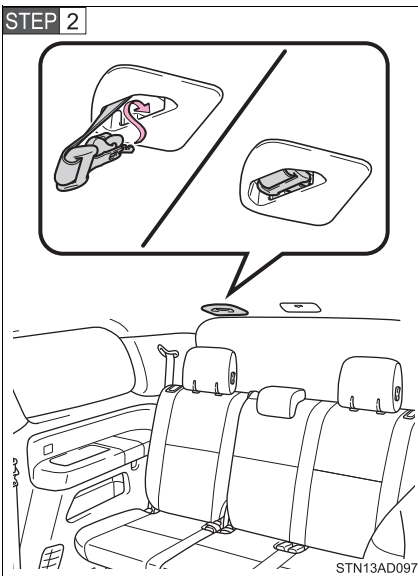

Stow the seat belt tabs in the cover set in the roof as shown.

1-3. Adjustable components (seats, mirrors, steering wheel)

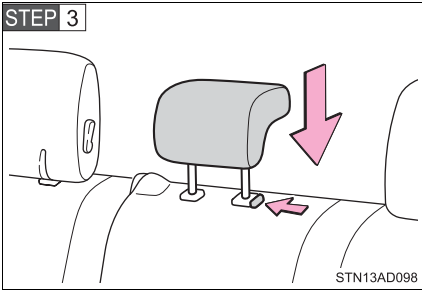

Adjust the center head restraint to the downmost position.

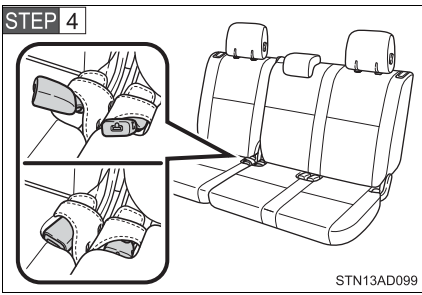

Stow the third seat belt buckles.

■ Folding down the third seat (manual seat)

STEP 1

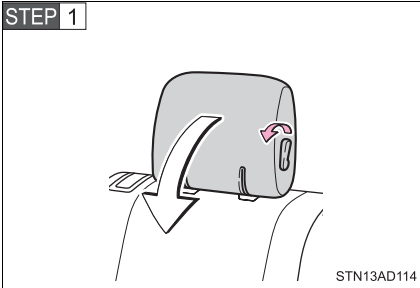

Pull the head restraint lock release lever to fold the head restraint.

STEP 2 Pull the lever to unlock the seatback and then fold the seatback down.

► From rear door side

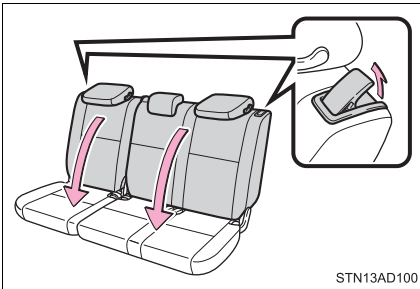

► From back door side

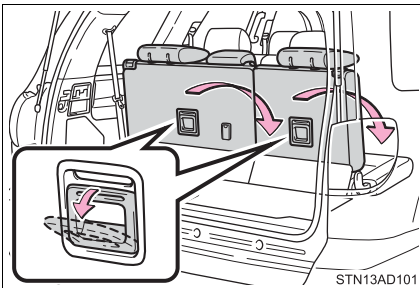

■ Folding down the third seat (power seat)

▶ From rear door side

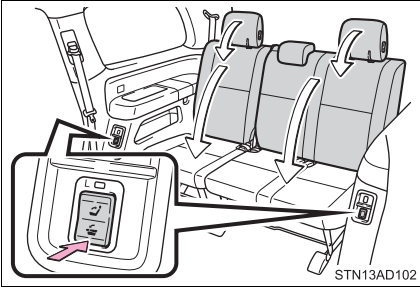

Press and hold the seatback folding switch until the seatback folds down fully and the buzzer sounds.

The outside head restraints are folded automatically.

▶ From back door side

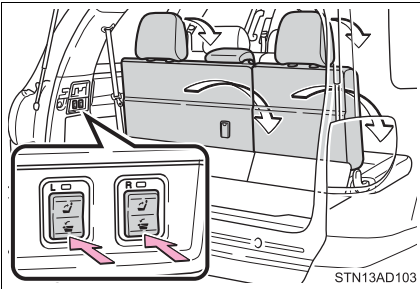

Press and hold the seatback folding switch until the seatback folds down fully and the buzzer sounds.

The outside head restraints are folded automatically.

■ The power third seat can be folded down/returned when

- Turn the engine switch to the LOCK position or the shift lever is in P, with the rear door opened. (from rear door side)
- Turn the engine switch to the LOCK position or the shift lever is in P, with the back door opened. (from back door side)

⚠ CAUTION**■ When adjusting a rear seat**

- Be careful that the seat does not hit passengers or luggage.
- Do not recline the seat more than necessary when the vehicle is in motion to reduce the risk of sliding under the lap belt. If the seat is too reclined, the lap belt may slide past the hips and apply restraint forces directly to the abdomen or your neck may contact the shoulder belt, increasing the risk of death or serious injury in the event of an accident.
- Do not depress the second seat release pedal from the third seat while the second seat is occupied.
- Be careful not to get your hands or feet caught in the seat.

■ Before folding down a rear seat

Do not fold down a rear seat when there are passengers sitting in the rear seats or when there is luggage placed on/under the rear seats.

■ After adjusting a seat

Observe the following precautions. Failure to do so may result in death or serious injury.

- Make sure that the seat and seatback are securely locked in position by lightly rocking them back and forth.
- Check that the seat belts are not twisted or caught under the seat.

⚠ NOTICE**■ When folding down the seats**

The seat belts and buckles must be stowed.

■ Second seatback board weight capacity

Do not place any object heavier than 220 lb. (100 kg) on the second seatback board.

■ Before sliding the second center seat to the most forward position (vehicles with bench type second seat)

Ensure that the cup holder on the front console box is closed.

1-3. Adjustable components (seats, mirrors, steering wheel) Driving position memory (driver's seat)*

Your preferred driving position (the position of the driver's seat, steering wheel and outside rear view mirrors) can be entered into the computer's memory and recalled with the touch of a button. Two different driving positions can be entered into memory.

■ Entering a position into memory

Check that the shift lever is set in P.

STEP 1 Turn the engine switch to the ON position.

STEP 2 Adjust the driver's seat, steering wheel, and outside rear view mirrors to the desired positions.

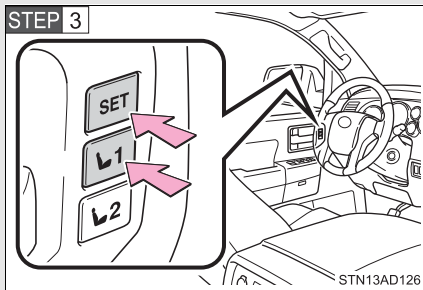

While pushing the SET button, push button "1" or "2" until the signal beeps.

If the selected button has already been preset, the previously recorded position will be overwritten.

■ Recalling the memorized position

Check that the shift lever is set in P.

STEP 1 Turn the engine switch to the ON position.

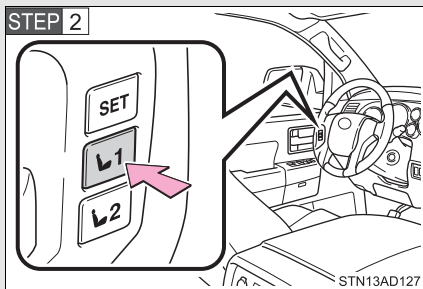

Push button "1" or "2" to recall the desired position.

*: If equipped

Linking driving position memory with door unlock operation

Memorized driving positions can be recalled when you unlock the driver's door using the wireless remote control and open the driver's door.

■ Setting the linked door unlock operation

STEP 1 Set the driving positions into the memory system using the "1" or "2" buttons. (→P. 62)

STEP 2 Turn the engine switch off then, close the driver's door.

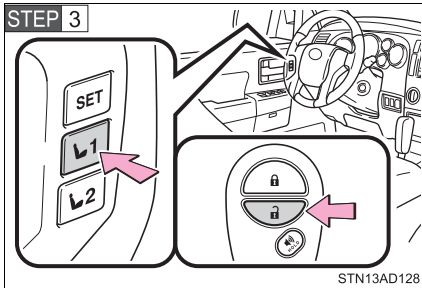

Push the "1" or "2" button and the  button on the wireless remote control at the same time for about 1 second until you hear a beep.

To prevent unintended triggering of the alarm, open and close a door once after a driving position has been recorded. (If a door is not opened within 60 seconds after  is pressed, the doors will be locked again and the alarm will automatically be set.)

In case the alarm is triggered, immediately stop the alarm.
(→P. 107)

■ Canceling the linked door unlock operation

STEP 1 Close the driver's door with the engine switch turned off.

STEP 2 Push the SET button and the  button on the wireless remote control at the same time for about 1 second until you hear 2 beeps.

■ **Retained accessory power**

Each memorized position (except for the tilt and telescopic steering column) can be activated within 30 seconds after the driver's door is opened, even if the key is not in the engine switch.

■ **If any position memory button is pushed while the adjustments are being made**

The operation will stop. To reactivate the system, push the button ("1" or "2") again.

■ **If the battery is disconnected**

The memorized positions must be reset because the computer's memory is erased when the battery is disconnected.

 **CAUTION**

■ **Seat adjustment caution**

Take care during seat adjustment that the seat does not strike the rear passenger or squeeze your body against the steering wheel.

If this happens, you can stop the movement by pressing another seat position memory button.

1-3. Adjustable components (seats, mirrors, steering wheel) Head restraints

Head restraints are provided for all seats.

► Front seats

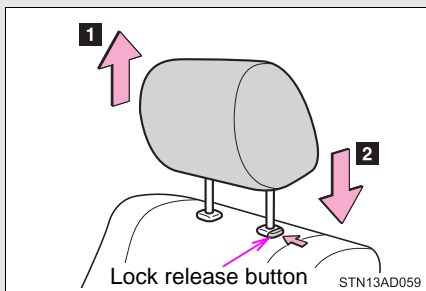

Vertical adjustment

1 Up

Pull the head restraints up.

2 Down

Push the head restraint down while pushing the lock release button.

► Second center* and outside seats

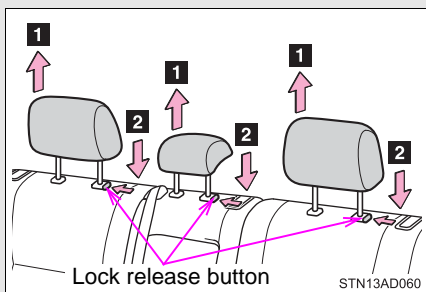

Vertical adjustment

1 Up

Pull the head restraints up.

2 Down

Push the head restraint down while pushing the lock release button.

*: 8-passenger models only

► Third center seat

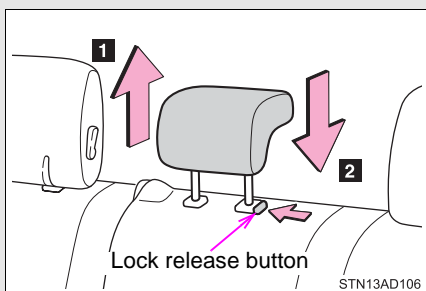

Vertical adjustment

1 Up

Pull the head restraints up.

2 Down

Push the head restraint down while pushing the lock release button.

► Third outside seats

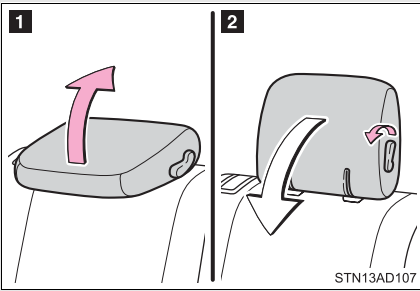

1 To use

Lift up the head restraint until it locks.

2 To fold

Pull the head restraint lock release lever to fold the head restraint.

■ Removing the head restraints

► Front seats

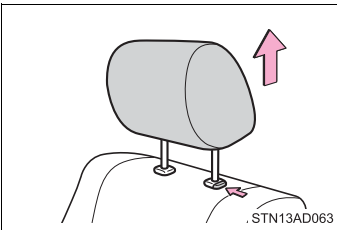

Pull the head restraint up while pushing the lock release button.

► Second seats

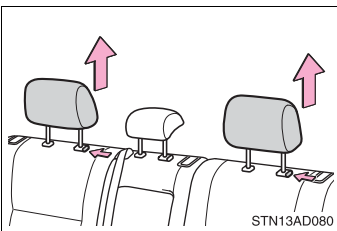

Pull the head restraint up while pushing the lock release button.

8-passenger models:

The head restraint of center seat cannot be removed.

► Third seats

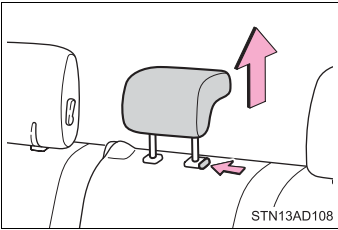

Pull the head restraint up while pushing the lock release button.

The head restraint of outside seat cannot be removed.

■ Installing the head restraints

► Front seats

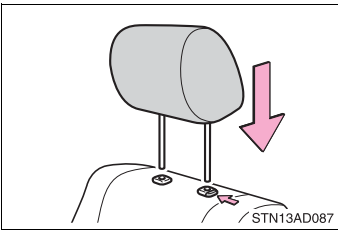

Align the head restraint with the installation holes and push it down to the lock position.

Press and hold the lock release button when lowering the head restraint.

► Second seats

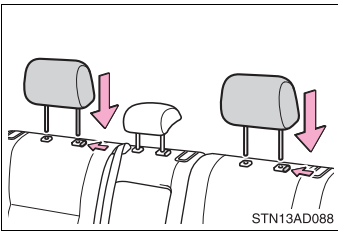

Align the head restraint with the installation holes and push it down to the lock position.

Press and hold the lock release button when lowering the head restraint.

► Third center seat

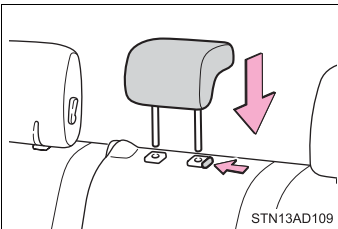

Align the head restraint with the installation holes and push it down to the lock position.

Press and hold the lock release button when lowering the head restraint.

■ **Adjusting the height of the head restraints (front and second outside seats)**

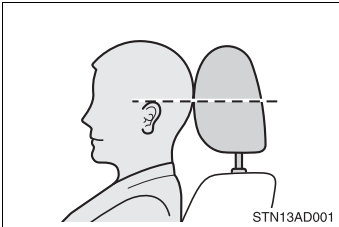

Make sure that the head restraints are adjusted so that the center of the head restraint is closest to the top of your ears.

■ **Adjusting the center seat head restraint**

Always raise the head restraint one level from the lowermost position when using.

⚠ CAUTION

■ **Head restraint precautions**

Observe the following precautions regarding the head restraints. Failure to do so may result in death or serious injury.

- Use the head restraints designed for each respective seat.
- Adjust the head restraints to the correct position at all times.
- After adjusting the head restraints, push down on them and make sure they are locked in position.
- Do not drive with the head restraints removed.

1-3. Adjustable components (seats, mirrors, steering wheel)

Seat belts

Make sure that all occupants are wearing their seat belts before driving the vehicle.

■ Correct use of the seat belts



- Extend the shoulder belt so that it comes fully over the shoulder, but does not come into contact with the neck or slide off the shoulder.
- Position the lap belt as low as possible over the hips.
- Adjust the position of the seatback. Sit up straight and well back in the seat.
- Do not twist the seat belt.

■ Fastening and releasing the seat belt

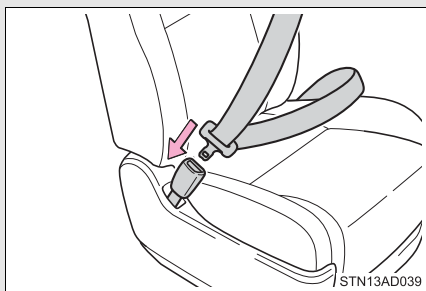

Fastening the belt

Push the tab into the buckle until a clicking sound is heard.

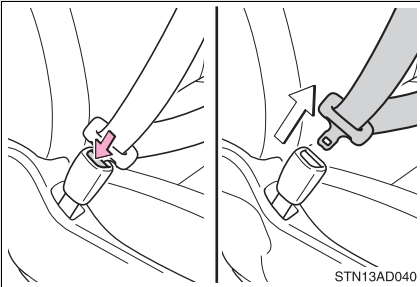

Releasing the belt

Press the release button.

■ Adjusting the height of the belt

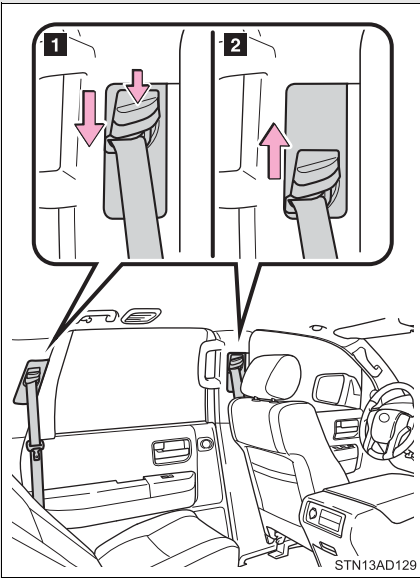

1 Down

2 Up

Move the height adjuster up and down as needed until you hear a click.

Third center seat belt

The third center seat belt is a 3-point type restraint with 2 buckles. Both seat belt buckles must be correctly located and securely latched for proper operation.

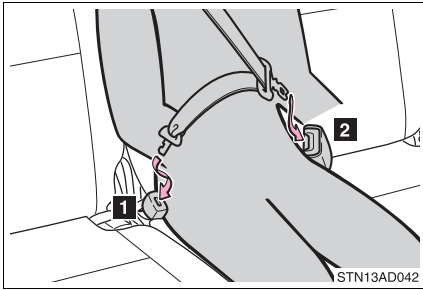

Make sure that the buckle **1** is securely latched for ready use of the center seat belt.

- 1** Matches the tab with the hooked end (tab "A")
- 2** Matches the tab with the concaved end (tab "B")

Release method

The belt can be completely released when not required, such as when folding down the third seat.

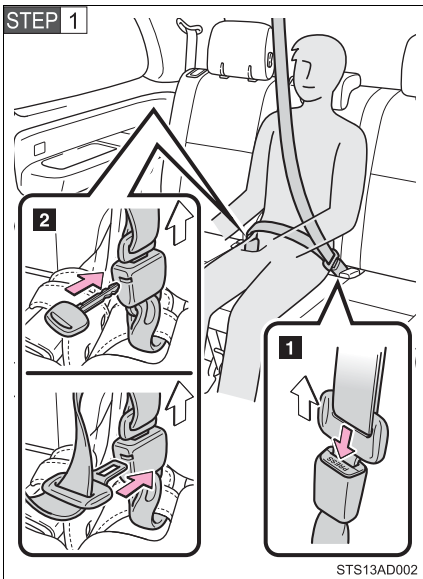

- 1** To release the tab "B", push the buckle release button.
- 2** To release the tab "A", insert the key (→P. 30) or tab "B" into the hole on the buckle.

Retract the belt slowly when releasing and stowing the seat belt.

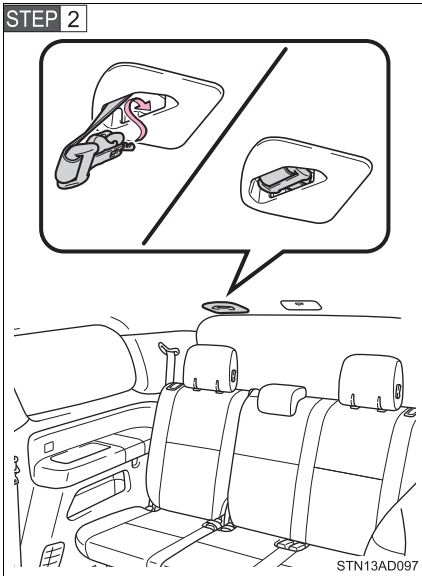

Stow the seat belt tabs in the cover set in the roof as shown.

■ Extracting the belt

Pull the belt out partially, and then remove the tabs from the cover.

Seat belt comfort guide (third center seat)

If the shoulder belt sits close to a person's neck, use the seat belt comfort guide.

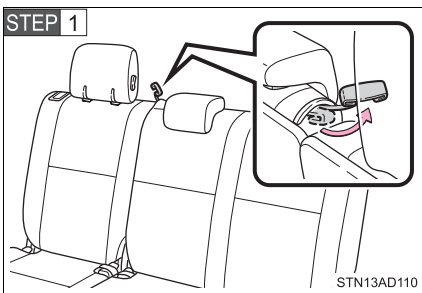

Pull the comfort guide from the pocket.

STEP 2

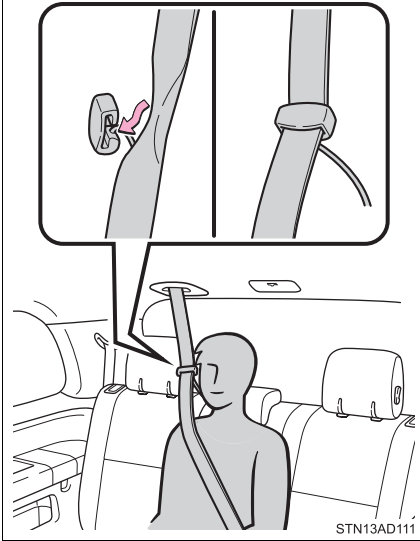

Slide the belt past the slot of the guide.

The elastic cord must be behind the seat belt.

1

Before driving

Seat belt pretensioners (front seats)

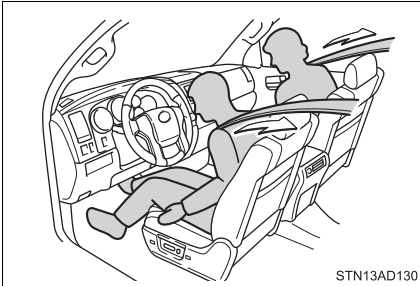

The pretensioner helps the seat belt to quickly restrain the occupant by retracting the seat belt when the vehicle is subjected to certain types of severe frontal collision or a vehicle rollover.

The pretensioner may not activate in the event of a minor frontal impact, a side impact or a rear impact.

■ **Emergency locking retractor (ELR)**

The retractor will lock the belt during a sudden stop or on impact. It may also lock if you lean forward too quickly. A slow, easy motion will allow the belt to extend so that you can move around fully.

■ **Automatic locking retractor (ALR)**

When a passenger's shoulder belt is completely extended and then retracted even slightly, the belt is locked in that position and cannot be extended. This feature is used to hold the child restraint system (CRS) firmly. To free the belt again, fully retract the belt and then pull the belt out once more. (→P. 133)

■ **Pregnant women**

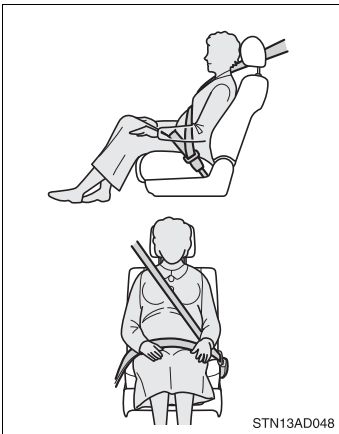

Obtain medical advice and wear the seat belt in the proper way. (→P. 69)

Women who are pregnant should position the lap belt as low as possible over the hips in the same manner as other occupants. Extend the shoulder belt completely over the shoulder and position the belt across the chest. Avoid belt contact over the rounding of the abdominal area.

If the seat belt is not worn properly, not only a pregnant woman, but also the fetus could suffer death or serious injury as a result of sudden braking or a collision.

■ **People suffering illness**

Obtain medical advice and wear the seat belt in the proper way.

■ Child seat belt usage

The seat belts of your vehicle were principally designed for persons of adult size.

- Use a child restraint system appropriate for the child, until the child becomes large enough to properly wear the vehicle's seat belt. (→P. 129)
- When the child becomes large enough to properly wear the vehicle's seat belt, follow the instructions on P. 69 regarding seat belt usage.

■ Replacing the belt after the pretensioner has been activated

If the vehicle is involved in multiple collisions, the pretensioner will activate for the first collision, but will not activate for the second or subsequent collisions.

■ Seat belt extender

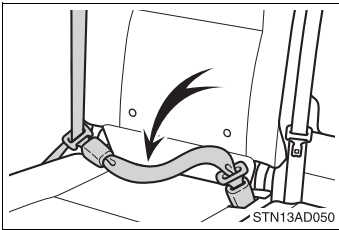

If your seat belts cannot be fastened securely because they are not long enough, a personalized seat belt extender is available from your Toyota dealer free of charge.

▲ CAUTION

Observe the following precautions to reduce the risk of injury in the event of sudden braking, sudden swerving or an accident. Failing to do so may cause death or serious injury.

■ Wearing a seat belt

- Ensure that all passengers wear a seat belt.
- Always wear a seat belt properly.
- Each seat belt should be used by one person only. Do not use a seat belt for more than one person at once, including children.
- Toyota recommends that children be seated in the rear seat and always use a seat belt and/or an appropriate child restraint system.

 CAUTION

■ **Wearing a seat belt**

- Do not recline the seat any more than necessary to achieve a proper seating position. The seat belt is most effective when the occupants are sitting up straight and well back in the seats.
- Do not wear the shoulder belt under your arm.
- Always wear your seat belt low and snug across your hips.

■ **When children are in the vehicle**

Do not allow children to play with the seat belt. If the seat belt becomes twisted around a child's neck, it may lead to choking or other serious injuries that could result in death. If this occurs and the buckle cannot be unfastened, scissors should be used to cut the belt.

■ **Adjustable shoulder anchor**

Always make sure the shoulder belt is positioned across the center of your shoulder. The belt should be kept away from your neck, but not falling off your shoulder. Failure to do so could reduce the amount of protection in an accident and cause death or serious injuries in the event of a sudden stop, sudden swerve or accident. (→P. 70)

■ **Seat belt pretensioners**

- Do not place anything, such as a cushion, on the front passenger's seat. Doing so will disperse the passenger's weight, which prevents the sensor from detecting the passenger's weight properly. As a result, the seat belt pretensioner for the front passenger's seat may not activate in the event of a collision.
- If the pretensioner has activated, the SRS warning light will come on. In that case, the seat belt cannot be used again and must be replaced at your Toyota dealer.

■ **Seat belt damage and wear**

- Do not damage the seat belts by allowing the belt, plate, or buckle to be jammed in the door.
- Inspect the seat belt system periodically. Check for cuts, fraying, and loose parts. Do not use a damaged seat belt until it is replaced. Damaged seat belt cannot protect an occupant from death or serious injury.

⚠ CAUTION**■ Seat belt damage and wear**

- Ensure that the belt and tab are locked and the belt is not twisted.
If the seat belt does not function correctly, immediately contact your Toyota dealer.
- Replace the seat assembly, including the belts, if your vehicle has been involved in a serious accident, even if there is no obvious damage.
- Do not attempt to install, remove, modify, disassemble or dispose of the seat belts. Have any necessary repairs carried out by your Toyota dealer. Inappropriate handling of the pretensioner may prevent it from operating properly resulting in death or serious injury.

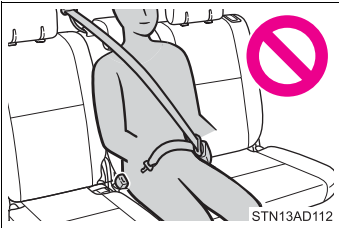
■ When using the third center seat belt

Do not use the third center seat belt with either buckle released. Fastening only one of the buckles may result in death or serious injury in case of sudden braking or a collision.

■ Using a seat belt comfort guide (third center seat)

- Make sure the belt is not twisted and that it lies flat. The elastic cord must be behind the belt and the guide must be on the front.
 - To reduce the chance of injury in case of a sudden stop, sudden swerve or accident while driving, remove and store the comfort guide in its pocket when it is not in use.
 - Always make sure the shoulder belt is positioned across the center of the shoulder. The belt should be kept away from the neck, and should not slide off the shoulder.
- Failure to observe these precautions could reduce the effectiveness of the seat belt in an accident, causing death or serious injury.

 CAUTION

■ **Using a seat belt extender**

- Do not wear the seat belt extender if you can fasten the seat belt without the extender.
- Do not use the seat belt extender when installing a child restraint system because the belt will not securely hold the child restraint system, increasing the risk of death or serious injury in the event of an accident.
- The personalized extender may not be safe on another vehicle, when used by another person, or at a different seating position other than the one originally intended.

 NOTICE

■ **When using a seat belt extender**

When releasing the seat belt, press on the buckle release button on the extender, not on the seat belt.

This helps prevent damage to the vehicle interior and the extender itself.

1-3. Adjustable components (seats, mirrors, steering wheel) Steering wheel (manually adjustable type)

The steering wheel can be adjusted to a comfortable position.

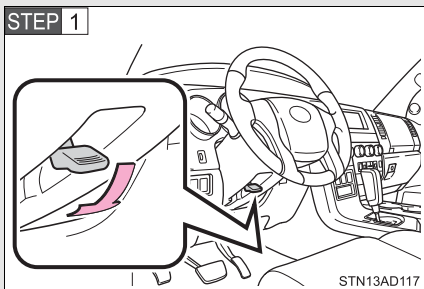

Hold the steering wheel and press the lever down.

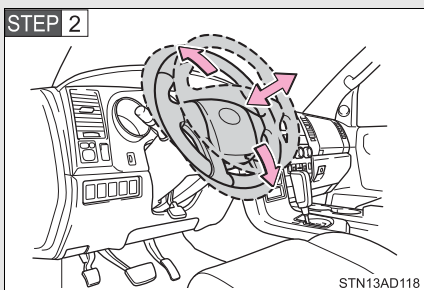

Adjust to the ideal position by moving the steering wheel horizontally and vertically.

After adjustment, pull the lever up to secure the steering wheel.

⚠ CAUTION

■ **Caution while driving**

Do not adjust the steering wheel while driving. Doing so may cause the driver to mishandle the vehicle and an accident, resulting in death or serious injury.

■ **After adjusting the steering wheel**

Make sure that the steering wheel is securely locked. Otherwise, the steering wheel may move suddenly, possibly causing an accident and resulting in death or serious injury.

1-3. Adjustable components (seats, mirrors, steering wheel)

Steering wheel (power-adjustable type)

The steering wheel can be adjusted to a comfortable position.

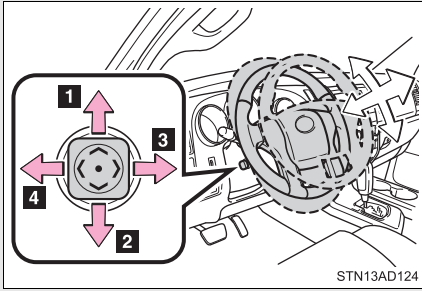

- 1 Up
- 2 Down
- 3 Toward the driver
- 4 Away from the driver

Auto tilt away

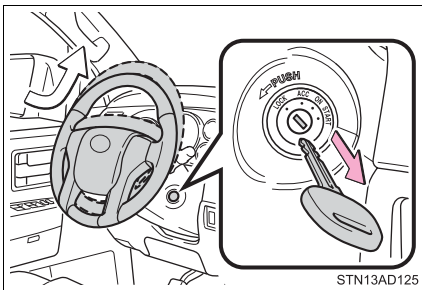

When the key is removed from the engine switch, the steering wheel returns to its stowed position by moving up and away to enable easier driver entry and exit.

Inserting the key into the engine switch returns the steering wheel to its original position.

⚠ CAUTION

■ Caution while driving

Do not adjust the steering wheel while driving.

Doing so may cause the driver to mishandle the vehicle and an accident, resulting in death or serious injury.

1-3. Adjustable components (seats, mirrors, steering wheel) Anti-glare inside rear view mirror

Glare from the headlights of vehicles behind can be reduced by using the following functions.

► Manual anti-glare inside rear view mirror

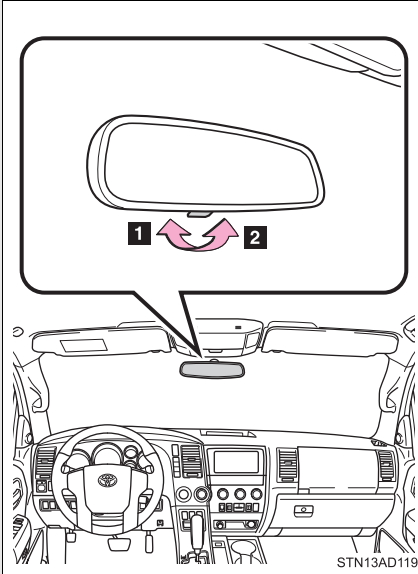

- 1 Normal position
- 2 Anti-glare position

► Auto anti-glare inside rear view mirror

In automatic mode, sensors are used to detect the headlights of vehicles behind and automatically reduces the reflected light.

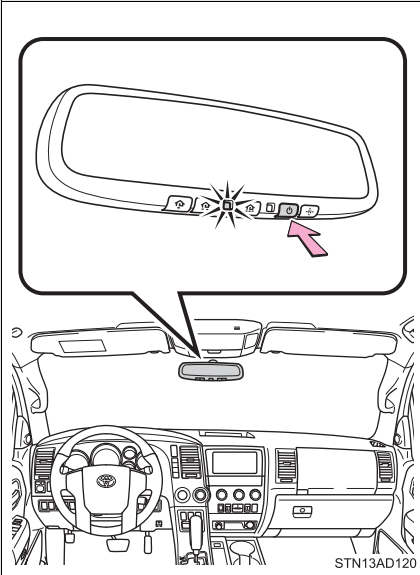

Turns automatic mode ON/OFF

The indicator comes on when automatic mode is turned on.

The mirror will revert to the automatic mode each time the engine switch is turned on.

Adjusting the height of rear view mirror

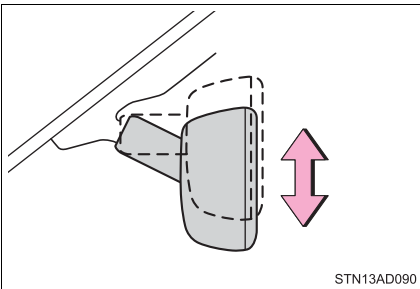

Adjust the height of the rear view mirror by moving it up and down.

■ **To prevent sensor error (vehicles with auto anti-glare inside rear view mirror)**

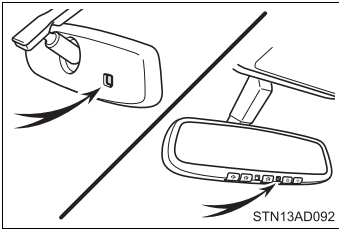

To ensure that the sensors operate properly, do not touch or cover them.

■ **If a sun visor interferes with the mirror**

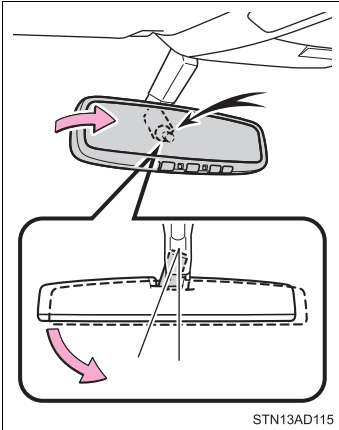

Hold and rotate the mirror to adjust the support.

⚠ CAUTION

■ **Caution while driving**

Do not adjust the position of the mirror while driving.
Doing so may lead to mishandling of the vehicle and cause an accident, resulting in death or serious injury.

1-3. Adjustable components (seats, mirrors, steering wheel) Outside rear view mirrors

Mirror angle can be adjusted using the switch when the engine switch is in the ACC or ON position.

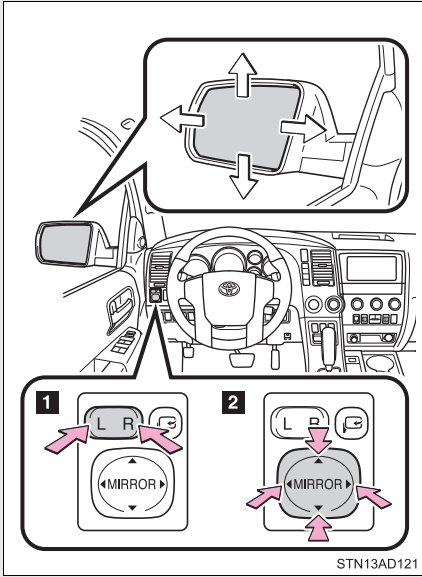

- 1 Select a mirror to adjust.
(L: left or R: right)
- 2 Adjust the mirror up, down, in or out using the switch.

Folding back the mirrors

► From outside

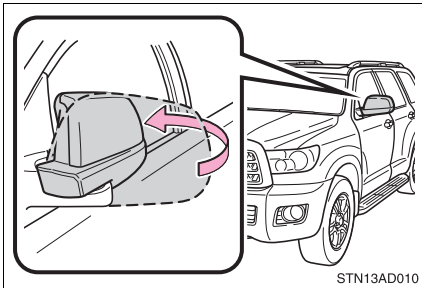

Push the mirrors towards the back of the vehicle to fold them.

► From inside (if equipped)



Press the switch.

Pressing again will unfold the mirrors.

Linked mirror function when reversing (if equipped)

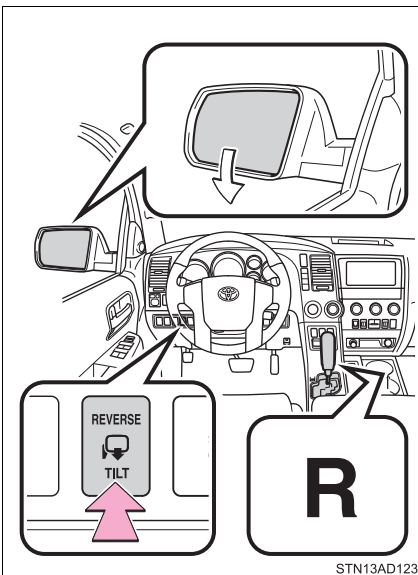

Press the switch to turn on/off linked mirror function.

The outside rear view mirrors will automatically tilt downwards when the vehicle is in reverse, in order to give a better view of ground.

■ **When the mirrors are fogged up (vehicles with outside rear view mirror defoggers)**

Turn on the mirror defoggers to defog the mirrors. (→P. 307)

■ **Automatic adjustment of the mirror angle (vehicles with driving position memory)**

A desired mirror face angle can be entered to memory and recalled automatically by the driving position memory. (→P. 62)

■ **Auto anti-glare function (if equipped)**

When the anti-glare inside rear view mirror is set to automatic mode, the outside rear view mirrors will activate in conjunction with the anti-glare inside rear view mirror to reduce reflected light. (→P. 81)

 **CAUTION**

■ **When driving the vehicle**

Observe the following precautions while driving.

Failing to do so may result in loss of control of the vehicle and cause an accident, resulting in death or serious injury.

- Do not adjust the mirrors while driving.
- Do not drive with the mirrors folded back.
- Both the driver and passenger side mirrors must be extended and properly adjusted before driving.

■ **When a mirror is moving**

To avoid personal injury and mirror malfunction, be careful not to get your hand caught by the moving mirror.

■ **When the mirror defoggers are operating (vehicles with outside rear view mirror defoggers)**

Do not touch the rear view mirror surfaces, as they can become very hot and burn you.



NOTICE

■ **If the mirrors are frozen**

Do not operate the control or scrape the mirror faces. Use a spray de-icer to free the mirror.

1-3. Adjustable components (seats, mirrors, steering wheel)

Roof luggage carrier

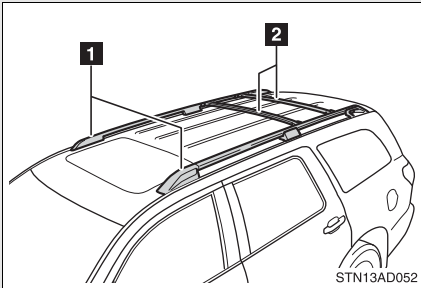

- 1 Roof rails
- 2 Cross rails

Adjustment the position of cross rails

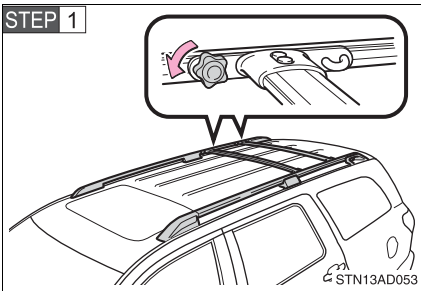

Turn the knobs counterclockwise to loosen the cross rails.

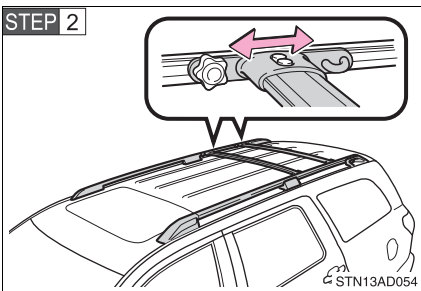

Slide the cross rails to the appropriate position for loading luggage.

After adjusting, be sure to tighten the cross rails by turning knobs clockwise.

 CAUTION**■ Cross rail adjustment**

Make sure the cross rails are locked securely by applying pressure forward and rearward.

Failure to do so may cause an accident, death or serious injury in the event of emergency braking or a collision.

■ When loading cargo

Observe the following precautions:

- Place the cargo so that its weight is distributed evenly between the front and rear axles.
- If loading long or wide cargo, never exceed the vehicle overall length or width. (→P. 512)
- Before driving, make sure the cargo is securely fastened to the roof luggage carrier.
- Loading cargo on the roof luggage carrier will raise the vehicle's center of gravity. Avoid high speeds, sudden starts, sharp turns, sudden braking or abrupt maneuvers, otherwise unexpected loss of control or vehicle rollover may occur.
- If driving for a long distance, on rough roads, or at high speeds, stop the vehicle occasionally during the trip to make sure the cargo remains securely fastened.
- Do not exceed 150 lb. (68 kg) cargo weight on the roof luggage carrier.

 NOTICE**■ When loading the luggage**

Be careful not to scratch the surface of the moon roof.

1-4. Opening and closing the windows and moon roof Power windows

The power windows can be opened and closed using the following switches.

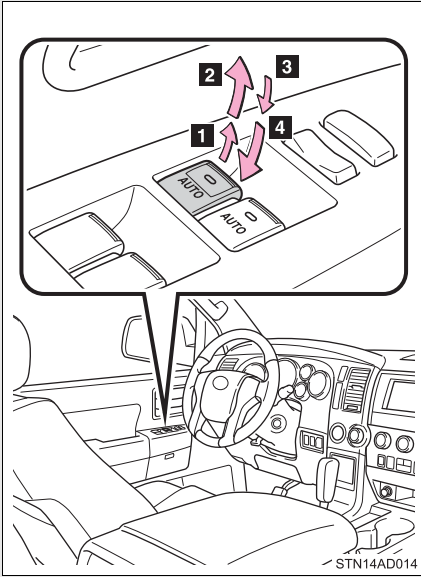

- 1** Closing
- 2** One-touch closing
(Front windows only)*
- 3** Opening
- 4** One-touch opening
(Front windows only)*

*: To stop the window partway, operate the switch in the opposite direction.

Lock switch

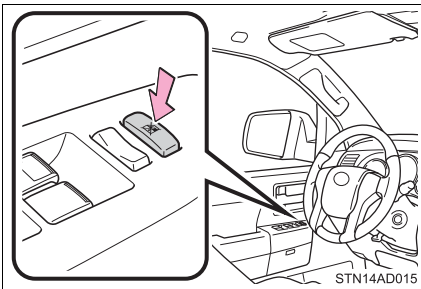

Press the switch down to lock passenger window switches and back window switch.

Use this switch to prevent children from accidentally opening or closing a passenger window and back window.

■ The power windows can be operated when

The engine switch is in the ON position.

■ Door lock linked power windows operation

The power windows can be opened and closed using the key. (→P. 35)

■ Operating the power windows after turning the engine switch off

The power windows can be operated for approximately 43 seconds even after the engine switch is turned to the ACC position or turned off. They cannot, however, be operated once either front door is opened.

■ Jam protection function (Front windows only)

If an object becomes caught between the window and the window frame, window travel is stopped and the window is opened slightly.

■ When the power window does not close normally

If the jam protection function is operating abnormally and a window cannot be closed, perform the following operations using the power window switch on the front door.

- After stopping the vehicle, the window can be closed by holding the power window switch in the one-touch closing position while the engine switch is turned to the ON position.
- If the window still cannot be closed even by carrying out the operation explained above, initialize the function by performing the following procedure.

STEP 1 Hold the power window switch in the one-touch closing position. Continue holding the switch for a further 6 seconds after the window has closed.

STEP 2 Hold the power window switch in the one-touch opening position. Continue holding the switch for a further 2 seconds after the window has opened completely.

STEP 3 Hold the power window switch in the one-touch closing position once again. Continue holding the switch for a further 2 seconds after the window has closed.

If you release the switch while the window is moving, start again from the beginning. If the window continues to close but then re-open slightly even after performing the above procedure correctly, have the vehicle inspected by your Toyota dealer.

■ **Customization that can be configured at Toyota dealer**

Settings (e.g. power windows) can be changed.
(Customizable features →P. 539)

 **CAUTION**

■ **Closing the windows**

Observe the following precautions.

Failing to do so may result in death or serious injury.

- The driver is responsible for all the power window operations, including the operation for the passengers. In order to prevent accidental operation, especially by a child, do not let a child operate the power windows. It is possible for children and other passengers to have body parts caught in the power window. Also, when riding with a child, it is recommended to use the window lock switch. (→P. 90)
- Check to make sure that all passengers do not have any part of their body in a position where it could be caught when a window is being operated.
- When using the key and operating the power windows, operate the power window after checking to make sure that there is no possibility of any passenger having any of their body parts caught in the window. Also do not let a child operate window by the key. It is possible for children and other passengers to get caught in the power window.
- When exiting the vehicle, turn the engine switch off, carry the key and exit the vehicle along with the child. There may be accidental operation, due to mischief, etc., that may possibly lead to an accident.

■ **Jam protection function**

- Never try jamming any part of your body to activate the jam protection function intentionally.
- The jam protection function may not work if something gets caught just before the window fully closes.

1-4. Opening and closing the windows and moon roof Power back window

The power back window can be opened and closed using the switch and key.

► From inside

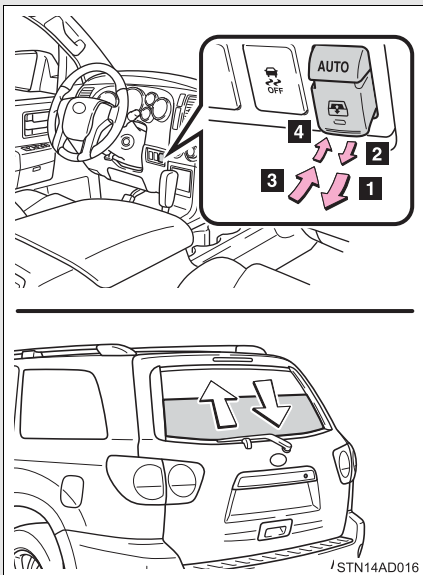

- 1 One-touch closing^{*1,*2}
- 2 Closing
- 3 One-touch opening^{*1}
- 4 Opening

*1: Pressing the switch in the opposite direction will stop window travel partway.

*2: During off-road traveling, the one-touch closing operation **1** may be deactivated depending on the vehicle speed and road surface conditions. At that time, close the window using the normal closing operation **2**.

► From outside

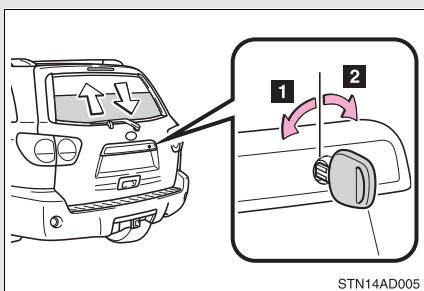

- 1 Opening
- 2 Closing

Turn the key fully and hold it.

■ **The power back window can be operated when**

- The engine switch is in the ON position.
- The power back window can be opened when the rear window wiper is working. At that time, the wiper stops working until the window is closed again.

If the rear window is not fully closed, the rear window wiper, washer, and defogger will not work.

■ **Operating the power back window after turning the engine switch off**

The power back window can be operated for approximately 43 seconds even after the engine switch is turned to the ACC position or turned off. It cannot, however, be operated once either front door is opened.

■ **Jam protection function**

If an object becomes caught between the window and the window frame, window travel is stopped and the window is opened slightly.

■ **When the power back window does not close normally**

If the jam protection function is operating abnormally and a window cannot be closed, perform the following operations using the power back window switch.

- After stopping the vehicle, the window can be closed by holding the power back window switch in the one-touch closing position while the engine switch is turned to the ON position.
- If the window still cannot be closed even by carrying out the operation explained above, initialize the function by performing the following procedure.

STEP 1 Hold the power back window switch in the one-touch closing position. Continue holding the switch for a further 6 seconds after the window has closed.

STEP 2 Hold the power back window switch in the one-touch opening position. Continue holding the switch for a further 2 seconds after the window has opened completely.

STEP 3 Hold the power back window switch in the one-touch closing position once again. Continue holding the switch for a further 2 seconds after the window has closed.

If you release the switch while the window is moving, start again from the beginning. If the window continues to close but then re-open slightly even after performing the above procedure correctly, have the vehicle inspected by your Toyota dealer.

■ Customization that can be configured at Toyota dealer

Settings (e.g. power back window) can be changed.
(Customizable features →P. 539)

CAUTION

■ Closing the power back window

Observe the following precautions.
Failing to do so may result in death or serious injury.

- The driver is responsible for all the power back window operations, including the operation for the passengers. In order to prevent accidental operation, especially by a child, do not let a child operate the power back window. It is possible for children and other passengers to have body parts caught in the power back window. Also, when riding with a child, it is recommended to use the window lock switch. (→P. 90)
- Check to make sure that all passengers do not have any part of their body in a position where it could be caught when a window is being operated.
- When using the key and operating the power back window, operate the power back window after checking to make sure that there is no possibility of any passenger having any of their body parts caught in the window. Also do not let a child operate window by the key. It is possible for children and other passengers to get caught in the power back window.
- When exiting the vehicle, turn the engine switch off, carry the key and exit the vehicle along with the child. There may be accidental operation, due to mischief, etc., that may possibly lead to an accident.

■ Jam protection function

- Never try jamming any part of your body to activate the jam protection function intentionally.
- The jam protection function may not work if something gets caught just before the window fully closes.

1-4. Opening and closing the windows and moon roof Moon roof*

Use the overhead switches to open, close, and tilt the moon roof up and down.

■ Opening and closing

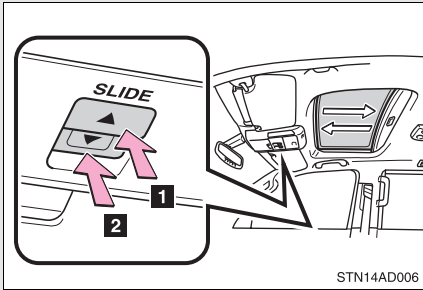

1 Open

The moon roof stops slightly before the fully open position to reduce wind noise.

Press the switch again to fully open the moon roof.

To stop partway, press the switch lightly.

2 Close

To stop partway, press the switch lightly.

■ Tilt up and down

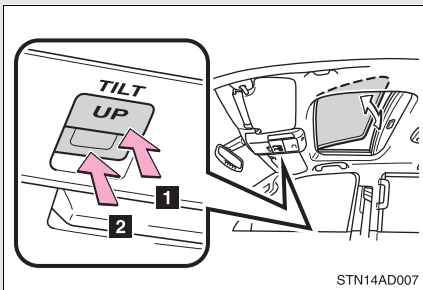

1 Tilt up

2 Tilt down

To stop partway, press the switch lightly.

*: If equipped

■ The moon roof can be operated when

The engine switch is in the ON position.

■ Door lock linked moon roof operation

The moon roof can be opened and closed using the key. (→P. 35)

■ Operating the moon roof after turning the engine switch off

The moon roof can be operated for approximately 43 seconds even after the engine switch is turned to the ACC or turned off. It cannot, however, be operated once either front door is opened.

■ Jam protection function

If an object is detected between the moon roof and the frame while closing or tilting down, travel is stopped and the moon roof opens slightly.

■ When the moon roof does not close normally

Perform the following procedure:

- If the moon roof closes but then re-opens slightly

STEP 1 Stop the vehicle.

STEP 2 Press and hold the “SLIDE” switch.*¹

The moon roof will close, reopen and pause for approximately 10 seconds.*² Then it will close again, tilt up and stop.

STEP 3 Check to make sure that the moon roof is completely stopped and then release the switch.

*¹:If the switch is released at the incorrect time, the procedure will have to be performed again from the beginning.

*²:If the switch is released after the above mentioned 10 seconds pause, automatic operation will be disabled. In that case, press and hold the “SLIDE” or “TILT” switch, and the moon roof will tilt up and stop. Check to make sure that the moon roof is completely stopped and then release the switch.

If the moon roof does not fully close even after performing the above procedure correctly, have the vehicle inspected by your Toyota dealer.

■ **To reduce wind noise**

When the moon roof is opened automatically, it will stop slightly before the full open position. Driving with the moon roof in this position can help reduce wind noise.

■ **Sunshade**

The sunshade can be opened and closed manually. However, the sunshade will open automatically when the moon roof is opened.

■ **Moon roof open reminder function**

An alarm will sound when the driver's door is opened with the moon roof not fully closed and the engine switch off.

■ **Customization that can be configured at Toyota dealer**

Settings (e.g. moon roof) can be changed.
(Customizable features →P. 539)

 **CAUTION****■ Opening the moon roof**

Observe the following precautions.

Failing to do so may cause death or serious injury.

- Do not allow any passengers to put their hands or heads outside the vehicle while it is moving.
- Do not sit on top of the moon roof.

■ Closing the moon roof

Observe the following precautions.

Failing to do so may result in death or serious injury.

- The driver is responsible for moon roof opening and closing operations. In order to prevent accidental operation, especially by a child, do not let a child operate the moon roof. It is possible for children and other passengers to have body parts caught in the moon roof.
- Check to make sure that all passengers do not have any part of their bodies in a position where they could be caught when the moon roof is being operated.
- When using the key and operating the moon roof, operate the moon roof after checking to make sure that there is no possibility of any passenger having any of their body parts caught in the moon roof. Also do not let a child operate moon roof by the key. It is possible for children and other passengers to get caught in the moon roof.
- When exiting the vehicle, turn the engine switch off, carry the key and exit the vehicle along with the child. There may be accidental operation, due to mischief, etc., that may possibly lead to an accident.

■ Jam protection function

- Never try jamming any part of your body to activate the jam protection function intentionally.
- The jam protection function may not work if something gets caught just before the moon roof fully closes.

Opening the fuel tank cap

Perform the following steps to open the fuel tank cap:

■ **Before refueling the vehicle**

- Turn the engine switch to the LOCK position and ensure that all the doors and windows are closed.
- Confirm the type of fuel. (→P. 515)

■ **Opening the fuel tank cap**

STEP 1

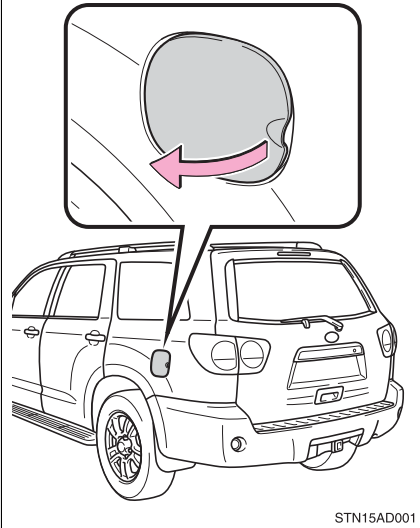

Open the fuel filler door.

STEP 2

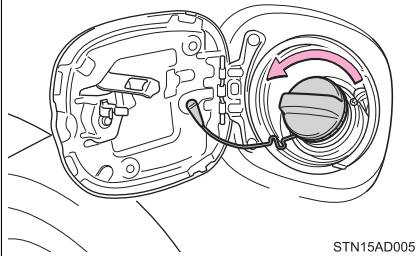

Turn the fuel tank cap slowly to open.

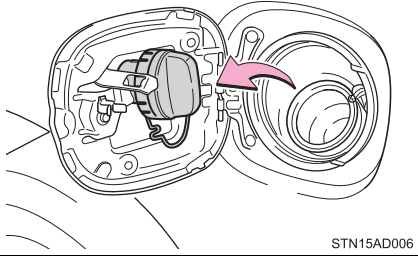
STEP 3

Hang the fuel tank cap on the back of the fuel filler door.

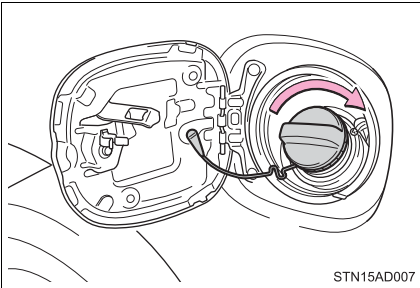
Closing the fuel tank cap

After refueling, turn the fuel tank cap until you hear a click. Once the cap is released, it will turn slightly in the opposite direction.

■ **Fuel types**

(→P. 515)

■ **E85 Fueling Stations (Flex-fuel engine)**

E85 fueling stations and fuel pumps can be identified by the indication “E85 85% Ethanol”. For more information about fueling stations, please refer to the U.S. Department of Energy Web site.

<http://www.afdc.energy.gov/afdc/locator/stations/>

■ **Refueling (Flex-fuel engine)**

Observe the following precautions when switching fuels, in order to maintain starting and driving performance.

- Do not change fuels when the fuel level is 1/4 or less.
- Always add at least 2.6 gal. (10 L) of fuel.
- After filling up with fuel, warm up the engine or drive the vehicle for at least 5 minutes or 7 miles (11 km).
- Do not accelerate rapidly immediately after refueling.

■ **Fuel tank opening for unleaded gasoline**

To help prevent incorrect fueling, your vehicle has a fuel tank opening that only accommodates the special nozzle on unleaded fuel pumps.

 **CAUTION**
■ When refueling the vehicle

Observe the following precautions while refueling the vehicle. Failure to do so may result in death or serious injury.

- After exiting the vehicle and before opening the fuel door, touch an unpainted metal surface to discharge any static electricity. It is important to discharge static electricity before refueling because sparks resulting from static electricity can cause fuel vapors to ignite while refueling.
- Always hold the grips on the fuel tank cap and turn it slowly to remove it. A whooshing sound may be heard when the fuel tank cap is loosened. Wait until the sound cannot be heard before fully removing the cap. In hot weather, pressurized fuel may spray out of the filler neck and cause injury.
- Do not allow anyone that has not discharged static electricity from their body to come close to an open fuel tank.
- Do not inhale vaporized fuel.
Fuel contains substances that are harmful if inhaled.
- Do not smoke while refueling the vehicle.
Doing so may cause the fuel to ignite and cause a fire.
- Do not return to the vehicle or touch any person or object that is statically charged.
This may cause static electricity to build up, resulting in a possible ignition hazard.

■ When refueling

Observe the following precautions to prevent fuel overflowing from the fuel tank:

- Securely insert the fuel nozzle into the fuel filler neck
- Stop filling the tank after the fuel nozzle automatically clicks off
- Do not top off the fuel tank.

■ When replacing the fuel tank cap

Do not use anything but a genuine Toyota fuel tank cap designed for your vehicle. Doing so may cause a fire or other incident which may result in death or serious injury.



NOTICE

■ Refueling

Do not spill fuel during refueling.

Doing so may damage the vehicle, such as causing the emission control systems to operate abnormally or damaging fuel system components or the vehicle's painted surface.

■ E85 fuel

E85 fuel can be used only in flex-fuel vehicles. Do not add E85 fuel to a gasoline-engine vehicle.

Filling a gasoline-engine vehicle with E85 fuel will have a negative impact on starting and driving performance and will cause damage to the fuel system components.

1-6. Theft deterrent system Engine immobilizer system

The vehicle's keys have built-in transponder chips that prevent the engine from starting if the key has not been previously registered in the vehicle's on-board computer.

Never leave the keys inside the vehicle when you leave the vehicle. This system is designed to help prevent vehicle theft but does not guarantee absolute security against all vehicle thefts.

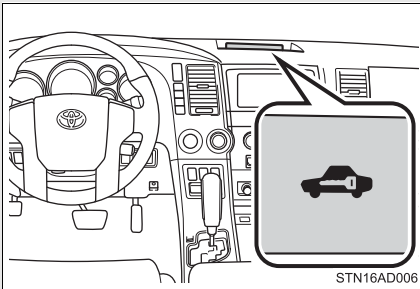

The indicator light flashes after the key has been removed from the engine switch to indicate that the system is operating.

The indicator light stops flashing after the registered key has been inserted into the engine switch to indicate that the system has been canceled.

1

Before driving

■ System maintenance

The vehicle has a maintenance-free type engine immobilizer system.

■ Conditions that may cause the system to malfunction

- If the key is in contact with a metallic object
- If the key is in close proximity to or touching a key to the security system (key with a built-in transponder chip) of another vehicle

■ Certifications for the engine immobilizer system

► For vehicles sold in the U.S.A.

FCC ID: MOZRI-42BTY

This device complies with part 15 of the FCC Rules. Operation is subject to the following two conditions: (1) This device may not cause harmful interference, and (2) this device must accept any interference received, including interference that may cause undesired operation.

FCC WARNING:

Changes or modifications not expressly approved by the party responsible for compliance could void the user's authority to operate the equipment.

► For vehicles sold in Canada

This device complies with Industry Canada licence-exempt RSS standard(s). Operation is subject to the following two conditions: (1) this device may not cause interference, and (2) this device must accept any interference, including interference that may cause undesired operation of the device.



NOTICE

■ **To ensure the system operates correctly**

Do not modify or remove the system. If modified or removed, the proper operation of the system cannot be guaranteed.

Alarm

The system sounds the alarm and flashes lights when forcible entry is detected.

■ Triggering of the alarm

The alarm is triggered in the following situations when the alarm is set.

- A locked door is unlocked or opened in any way other than using the wireless remote control door lock function or key. The doors will lock again automatically.
- The hood is opened.
- Vehicles with the glass breakage sensor (if equipped): The side windows are tapped or broken.
- The battery is reconnected.

■ Setting the alarm system

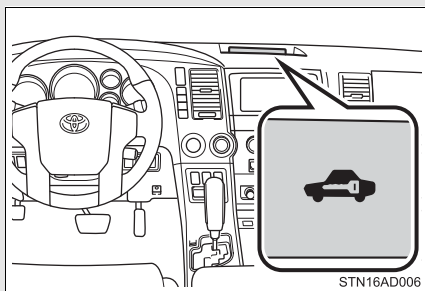

Close the doors and hood, and lock all the doors. The system will be set automatically after 30 seconds.

The indicator light changes from being on to flashing when the system is set.

■ Deactivating or stopping the alarm

- Unlock the doors.
- Turn the engine switch to the ACC or ON position, or start the engine.
(The alarm will be deactivated or stopped after a few seconds.)

■ System maintenance

The vehicle has a maintenance-free type alarm system.

■ Items to check before locking the vehicle

To prevent unexpected triggering of the alarm and vehicle theft, make sure of the following.

- Nobody is in the vehicle.
- The windows and moon roof are closed before the alarm is set.
- No valuables or other personal items are left in the vehicle.

■ Triggering of the alarm

The alarm may be triggered in the following situations.
(Stopping the alarm deactivates the alarm system.)

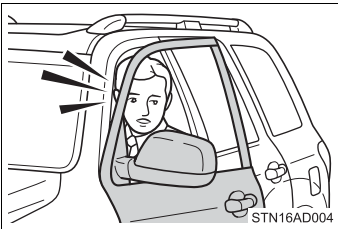

- A person inside the vehicle opens a door or hood.

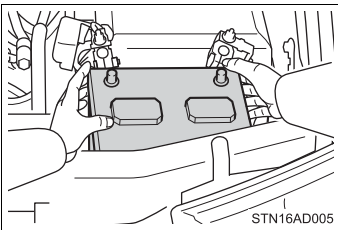

- The battery is recharged or replaced when the vehicle is locked.

■ Panic mode

→P. 32

■ When the battery is disconnected

Be sure to cancel the alarm system.

If the battery is discharged before canceling the alarm, the system may be triggered when the battery is reconnected.

■ Alarm-operated door lock

In the following cases, depending on the situation, the door may automatically lock to prevent improper entry into the vehicle:

- When a person remaining in the vehicle locks the door and the alarm is activated.
- While the alarm is activated, a person remaining in the vehicle unlocks the door.
- When recharging or replacing the battery.



NOTICE

■ To ensure the system operates correctly

Do not modify or remove the system. If modified or removed, the proper operation of the system cannot be guaranteed.

Correct driving posture

Drive in a good posture as follows:

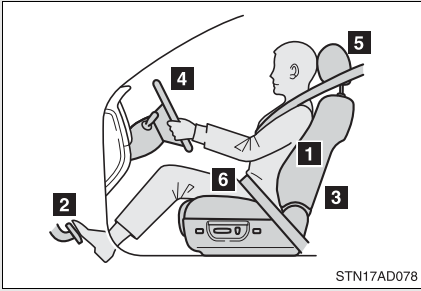

- 1** Sit upright and well back in the seat. (→P. 48)
- 2** Adjust the position of the seat forward or backward to ensure the pedals can be reached and easily depressed to the extent required. (→P. 48)
- 3** Adjust the seatback so that the controls are easily operable.
- 4** Adjust the tilt and telescopic positions of the steering wheel downward so the air-bag is facing your chest. (→P. 79, 80)
- 5** Lock the head restraint in place with the center of the head restraint closest to the top of your ears. (→P. 65)
- 6** Wear the seat belt correctly. (→P. 69)

 **CAUTION****■ While driving**

- Do not adjust the position of the driver's seat while driving.
Doing so could cause the driver to lose control of the vehicle.
- Do not place a cushion between the driver or passenger and the seatback.
A cushion may prevent correct posture from being achieved, and reduce the effectiveness of the seat belt and head restraint, increasing the risk of death or serious injury to the driver or passenger.
- Do not place anything under the front seats except for putting them in the auxiliary box.
Objects placed under the front seats may become jammed in the seat tracks and stop the seat from locking in place. This may lead to an accident. The adjustment mechanism may also be damaged.

■ Adjusting the seat position

- Do not recline the seat more than necessary when the vehicle is in motion, to reduce the risk of sliding under the lap belt.
If the seat is too reclined during an accident, the lap belt may slide past the hips and apply restraint forces directly to the abdomen or your neck may contact the shoulder belt, increasing the risk of death or serious injury.
- Take care when adjusting the seat position to ensure that other passengers are not injured by the moving seat.
- Do not put your hands under the seat or near the moving parts to avoid injury.
Fingers or hands may become jammed in the seat mechanism.

SRS airbags

The SRS airbags inflate when the vehicle is subjected to certain types of severe impacts that may cause significant injury to the occupants. They work together with the seat belts to help reduce the risk of death or serious injury.

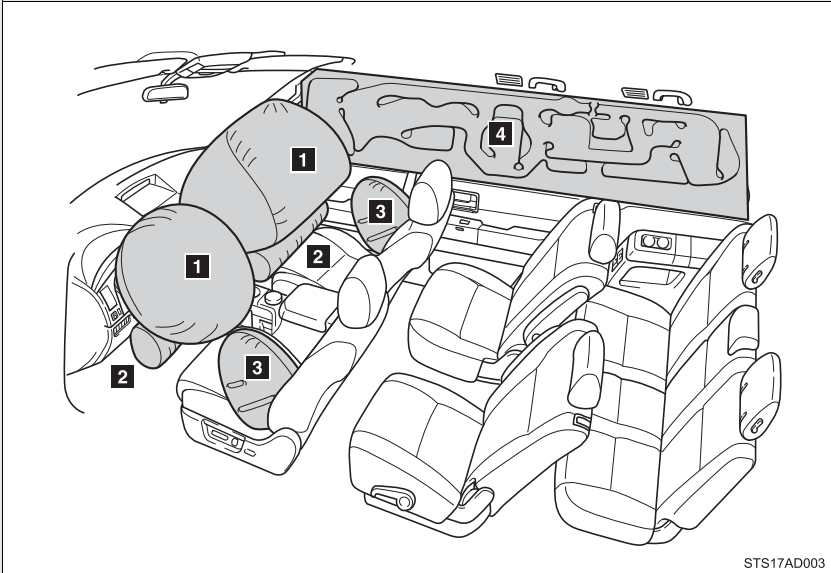

► SRS front airbags

1 SRS driver airbag/front passenger airbag

Can help protect the head and chest of the driver and front passenger from impact with interior components.

2 SRS knee airbags

Can help provide driver and front passenger protection.

► SRS side and curtain shield airbags

3 SRS side airbags

Can help protect the torso of the front seat occupants.

4 SRS curtain shield airbags

● Can help protect primarily the head of occupants in the outer seats.

● Can prevent the occupants from being thrown from the vehicle in the event of vehicle rollover.

Airbag system components

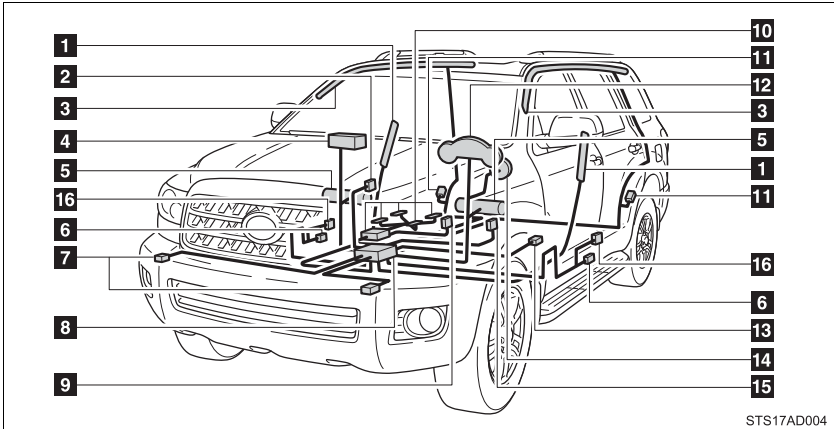

1 Side airbags

2 AIR BAG ON and AIR BAG OFF indicator lights

3 Curtain shield airbags

4 Front passenger airbag

5 Knee airbags

6 Side and curtain shield airbag sensors

7 Front airbag sensors

8 Airbag sensor assembly

9 Front passenger's seat belt buckle switch

10 Front passenger occupant classification system (ECU and sensors)

11 Curtain shield airbag sensors

12 SRS warning light

13 Driver's seat position sensor

14 Driver airbag

15 Driver's seat belt buckle switch

16 Seat belt pretensioners and force limiters

STS17AD004

Your vehicle is equipped with ADVANCED AIRBAGS designed based on the US motor vehicle safety standards (FMVSS208). The airbag sensor assembly (ECU) controls airbag deployment based on information obtained from the sensors etc. shown in the system components diagram above. This information includes crash severity and occupant information. As the airbags deploy, a chemical reaction in the inflators quickly fills the airbags with non-toxic gas to help restrain the motion of the occupants.

■ SRS warning light

This warning light system monitors the airbag sensor assembly, front airbag sensors, side and curtain shield airbag sensor assemblies, curtain shield airbag sensor assemblies, driver's seat position sensor, driver's seat belt buckle switch, front passenger occupant classification system (ECU and sensors), AIR BAG ON and AIR BAG OFF indicator lights, front passenger's seat belt buckle switch, front seat belt pretensioner assemblies, airbags, interconnecting wiring and power sources. (→P. 470)

■ If the SRS airbags deploy (inflate)

- Slight abrasions, burns, bruising etc., may be sustained from SRS airbags, due to the extremely high speed deployment (inflation) by hot gases.
- A loud noise and white powder will be emitted.
- Parts of the airbag module (steering wheel hub, airbag cover and inflator) as well as the front seats, and parts of the front and rear pillars and roof side rail, may be hot for several minutes. The airbag itself may also be hot.
- The front windshield may crack.

■ Operating conditions (front airbags)

- The SRS front airbags will deploy in the event of an impact that exceeds the set threshold level (the level of force corresponding to an approximately 12-18 mph [20-30 km/h] frontal collision with a fixed wall that does not move or deform).

However, this threshold velocity will be considerably higher if the vehicle strikes an object, such as a parked vehicle or sign pole, which can move or deform on impact, or if the vehicle is involved in an underride collision (e.g. a collision in which the front of the vehicle “underrides”, or goes under the bed of a truck, etc.).

- Depending on the type of collision, it is possible that only the seat belt pretensioners will activate.
- The SRS front airbags for the front passenger will not activate if there is no passenger sitting in the front passenger seat. However, the SRS front airbags for the front passenger may deploy if luggage is put in the seat, even if the seat is unoccupied. (→P. 124)

■ Operating conditions (side airbags & curtain shield airbags)

The SRS side airbags & SRS curtain shield airbags will deploy in the event of an impact that exceeds the set threshold level (the level of force corresponding to the impact force produced by an approximately 3300 lb. [1500 kg] vehicle colliding with the vehicle cabin from a direction perpendicular to the vehicle orientation at an approximate speed of 12-18 mph [20-30 km/h]).

■ Operating conditions (curtain shield airbags)

The SRS curtain shield airbags are designed to inflate when the passenger compartment is subjected to a severe impact from the side or vehicle roll-over. Depending on the conditions and type of accident, there are times when the curtain shield airbags may deploy (inflate) in a front impact.

■ **Conditions under which the SRS airbags may deploy (inflate), other than a collision**

The SRS front airbags may also deploy if a serious impact occurs to the underside of your vehicle. Some examples are shown in the illustration.

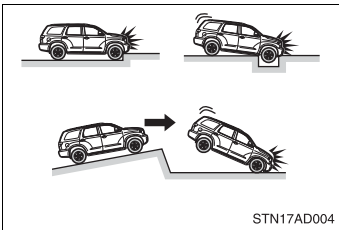

- Hitting a curb, edge of pavement or hard surface
- Falling into or jumping over a deep hole
- Landing hard or vehicle falling

The SRS curtain shield airbags may also deploy under the situation shown in the illustration.

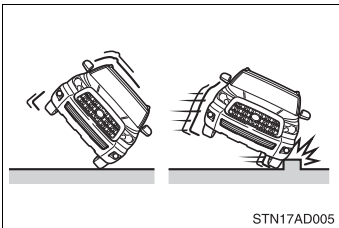

- The angle of vehicle tip-up is marginal.
- The vehicle skids and hits a curb stone.

■ **Types of collisions that may not deploy the SRS airbag (front airbags)**

The SRS front airbags are generally not designed to inflate if the vehicle is involved in a side or rear collision, if it rolls over, or if it is involved in a low-speed frontal collision. But, whenever a collision of any type causes sufficient forward deceleration of the vehicle, deployment of the SRS front airbags may occur.

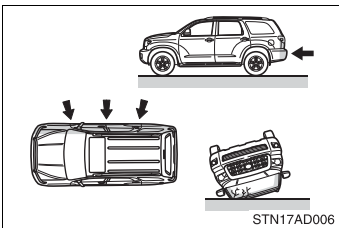

- Collision from the side
- Collision from the rear
- Vehicle rollover

■ Types of collisions that may not deploy the SRS airbag (side airbags and curtain shield airbags)

The SRS side airbag and curtain shield airbag system may not activate if the vehicle is subjected to a collision from the side at certain angles, or a collision to the side of the vehicle body other than the passenger compartment.

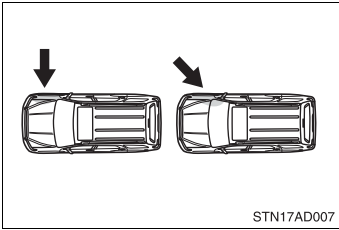

- Collision from the side to the vehicle body other than the passenger compartment
- Collision from the side at an angle

The SRS side airbags are not generally designed to inflate if the vehicle is involved in a frontal or rear collision, if it rolls over, or if it is involved in a low-speed side collision.

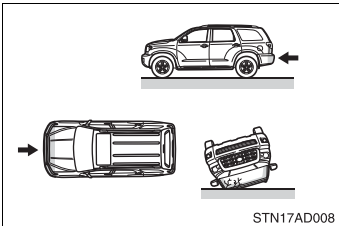

- Collision from the front
- Collision from the rear
- Vehicle rollover

The SRS curtain shield airbags are not generally designed to inflate if the vehicle is involved in a rear collision, if it pitches end over end, or if it is involved in a low-speed side collision.

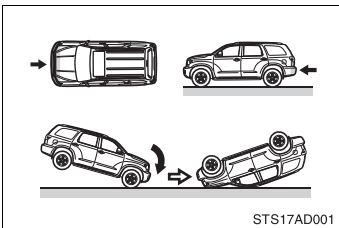

- Collision from the front*
- Collision from the rear
- Pitching end over end

*: Depending on the conditions and type of accident, the curtain shield airbags may deploy (inflate) upon frontal impact.

■ When to contact your Toyota dealer

In the following cases, contact your Toyota dealer as soon as possible.

- Any of the SRS airbags have been inflated.

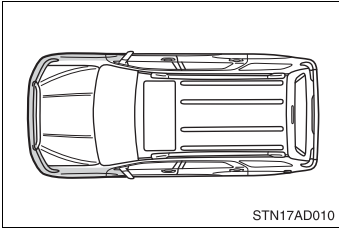

- The front of the vehicle is damaged or deformed, or was involved in an accident that was not severe enough to cause the SRS airbags to inflate.

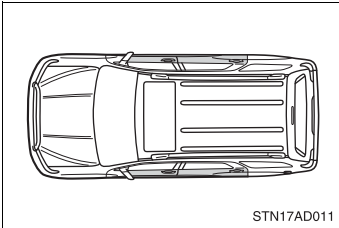

- A portion of a door is damaged or deformed, or the vehicle was involved in an accident that was not severe enough to cause the SRS side airbags and curtain shield airbags to inflate.

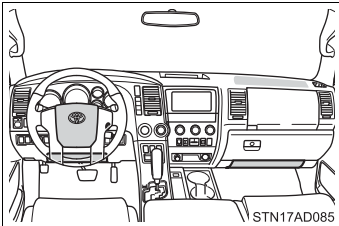

- The pad section of the steering wheel, dashboard near the front passenger airbag or lower portion of the instrument panel is scratched, cracked, or otherwise damaged.

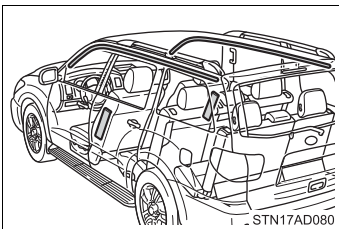

- The surface of the seats with the side airbag is scratched, cracked or otherwise damaged.
- The portion of the front pillars, rear pillars or roof side rail garnishes (padding) containing the curtain shield airbags inside is scratched, cracked or otherwise damaged.

 CAUTION

■ SRS airbag precautions

Observe the following precautions regarding the airbags.
Failure to do so may cause death or serious injury.

- The driver and all passengers in the vehicle must wear their seat belts properly.

The SRS airbags are supplemental devices to be used with the seat belts.

- The SRS driver airbag deploys with considerable force, and can cause death or serious injury especially if the driver is very close to the airbag. The National Highway Traffic Safety Administration (“NHTSA”) advises:

Since the risk zone for the driver’s airbag is the first 2 - 3 in. (50 - 75 mm) of inflation, placing yourself 10 in. (250 mm) from your driver airbag provides you with a clear margin of safety. This distance is measured from the center of the steering wheel to your breastbone. If you now sit less than 10 in. (250 mm) away, you can change your driving position in several ways:

- Move your seat to the rear as far as you can while still reaching the pedals comfortably.
- Slightly recline the back of the seat.
Although vehicle designs vary, many drivers can achieve the 10 in. (250 mm) distance, even with the driver seat all the way forward, simply by reclining the back of the seat somewhat. If reclining the back of your seat makes it hard to see the road, raise yourself by using a firm, non-slippery cushion, or raise the seat if your vehicle has that feature.
- If your steering wheel is adjustable, tilt it downward. This points the airbag toward your chest instead of your head and neck.

The seat should be adjusted as recommended by NHTSA above, while still maintaining control of the foot pedals and steering wheel, and your view of the instrument panel controls.

⚠ CAUTION

■ SRS airbag precautions

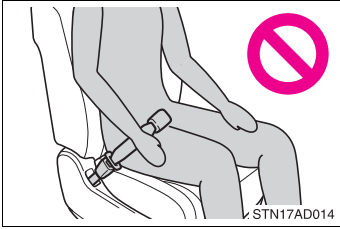

● If the seat belt extender has been connected to the front seat belt buckles but the seat belt extender has not also been fastened to the latch plate of the seat belt, the SRS front airbags will judge that the driver and front passenger are wearing the seat belt even though the seat belt has not been connected. In this case, the SRS front airbags may not activate correctly in a collision, resulting in death or serious injury in the event of a collision. Be sure to wear the seat belt with the seat belt extender.

- The SRS front passenger airbag also deploys with considerable force, and can cause death or serious injury especially if the front passenger is very close to the airbag. The front passenger seat should be as far from the airbag as possible with the seatback adjusted, so the front passenger sits upright.
- Improperly seated and/or restrained infants and children can be killed or seriously injured by a deploying airbag. An infant or child who is too small to use a seat belt should be properly secured using a child restraint system. Toyota strongly recommends that all infants and children be placed in the rear seats of the vehicle and properly restrained. The rear seats are the safest for infants and children. (→P. 129)

 CAUTION

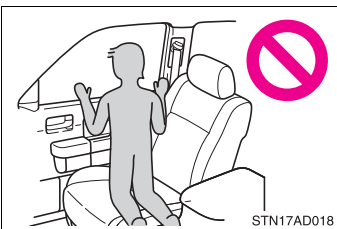
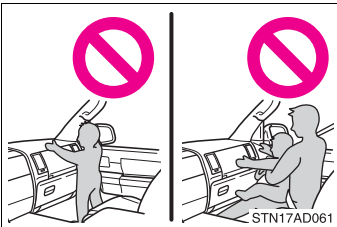
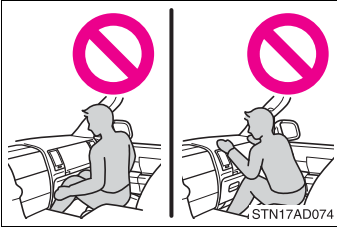
■ SRS airbag precautions

- Do not sit on the edge of the seat or lean against the dashboard.
- Do not allow a child to stand in front of the SRS front passenger airbag unit or sit on the knees of a front passenger.
- Do not drive the vehicle while the driver or passenger has items resting on their knees.
- Do not lean against the door, the roof side rail or the front, side and rear pillars.
- Do not allow anyone to kneel on the passenger seat toward the door or put their head or hands outside the vehicle.

! CAUTION

■ SRS airbag precautions

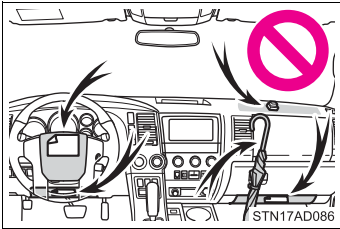

- Do not attach anything to or lean anything against areas such as the dashboard, steering wheel pad or lower portion of the instrument panel.

These items can become projectiles when SRS driver, front passenger and knee airbags deploy.

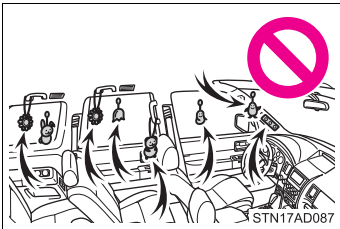

- Do not attach anything to areas such as the door, windshield glass, side door glass, front and rear pillars, roof side rail or assist grip.

- Do not hang coat hangers or other hard objects on the coat hooks. All of these items could become projectiles and seriously injure or kill you, should the SRS curtain shield airbag deploy.

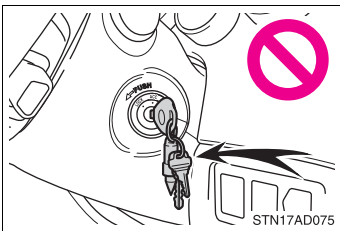

- Do not attach any heavy, sharp or hard objects such as keys or accessories to the key. The objects may restrict the SRS knee airbag inflation or be thrust into the driver's seat area by the force of the deploying airbag, thus causing a danger.

- If the vinyl cover is put on the area where the SRS knee airbags will deploy, be sure to remove it.
- Do not use seat accessories which cover the parts where the SRS side airbags inflate as they may interfere with inflation of the SRS airbags.
- Do not strike or apply significant levels of force to the area of the SRS airbag components (→P. 113).
Doing so can cause the SRS airbags to malfunction.
- Do not touch any of the component parts immediately after the SRS airbags have deployed (inflated) as they may be hot.

 **CAUTION****■ SRS airbag precautions**

- If breathing becomes difficult after the SRS airbag has deployed, open a door or window to allow fresh air in, or leave the vehicle if it is safe to do so. Wash off any residue as soon as possible to prevent skin irritation.
- If the areas where the SRS airbags are stored, such as the steering wheel pad and front and rear pillar garnishes, are damaged or cracked, have them replaced by your Toyota dealer.

■ Modification and disposal of SRS airbag system components

Do not dispose of your vehicle or perform any of the following modifications without consulting your Toyota dealer.

The SRS airbags may malfunction or deploy (inflate) accidentally, causing death or serious injury.

- Installation, removal, disassembly and repair of the SRS airbags.
- Repairs, modifications, removal or replacement of the steering wheel, instrument panel, dashboard, seats or seat upholstery, front, side and rear pillars or roof side rails.
- Repairs or modifications of the front fender, front bumper, or side of the occupant compartment.
- Installation of a grille guard (bull bars, kangaroo bar, etc.), snow plows, winches or roof luggage carrier.
- Modifications to the vehicle's suspension system.
- Installation of electronic devices such as mobile two-way radios or CD players.
- Modifications to your vehicle for a person with a physical disability.

Front passenger occupant classification system

Your vehicle is equipped with a front passenger occupant classification system. This system detects the conditions of the front passenger seat and activates or deactivates the devices for the front passenger.

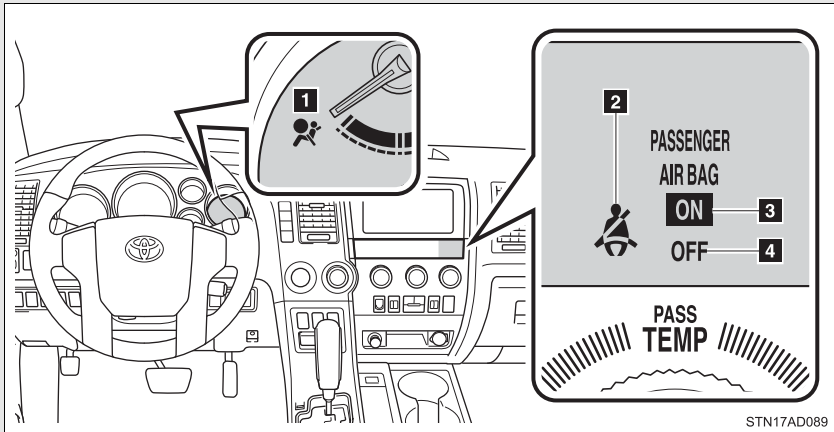

- 1** SRS warning light
- 2** Front passenger's seat belt reminder light
- 3** AIR BAG ON indicator light
- 4** AIR BAG OFF indicator light

Conditions and operation of the front passenger occupant classification system

■ Adult*¹

Indicator/ warning light	AIR BAG ON and AIR BAG OFF indicator lights	AIR BAG ON
	SRS warning light	Off
	Front passenger's seat belt reminder light	Flashing* ²
Devices	Front passenger airbag	Activated
	Front passenger knee airbag	
	Side airbag on the front passenger seat	
	Curtain shield airbag in the front passenger side	
	Front passenger's seat belt pretensioner	

■ Child*³ or child restraint system*⁴

Indicator/ warning light	AIR BAG ON and AIR BAG OFF indicator lights	AIR BAG OFF* ⁵
	SRS warning light	Off
	Front passenger's seat belt reminder light	Flashing* ²
Devices	Front passenger airbag	Deactivated
	Front passenger knee airbag	
	Side airbag on the front passenger seat	Activated
	Curtain shield airbag in the front passenger side	
	Front passenger's seat belt pretensioner	

■ **Unoccupied**

Indicator/ warning light	AIR BAG ON and AIR BAG OFF indicator lights	Not illuminated
	SRS warning light	Off
	Front passenger's seat belt reminder light	
Devices	Front passenger airbag	Deactivated
	Front passenger knee airbag	
	Side airbag on the front passenger seat	Activated
	Curtain shield airbag in the front passenger side	
	Front passenger's seat belt pretensioner	Deactivated

■ **There is a malfunction in the system**

Indicator/ warning light	AIR BAG ON and AIR BAG OFF indicator lights	AIR BAG OFF
	SRS warning light	On
	Front passenger's seat belt reminder light	Off
Devices	Front passenger airbag	Deactivated
	Front passenger knee airbag	
	Side airbag on the front passenger seat	Activated
	Curtain shield airbag in the front passenger side	
	Front passenger's seat belt pretensioner	

*1: The system judges a person of adult size as an adult. When a smaller adult sits in the front passenger seat, the system may recognize him/her as a child depending on his/her physique and posture.

*2: In the event the front passenger does not wear a seat belt.

- *3: When a larger child who has outgrown a child restraint system sits in the front passenger seat, the system may recognize him/her as an adult depending on his/her physique or posture.
- *4: Never install a rear-facing child restraint system on the front passenger seat. A forward-facing child restraint system should only be installed on the front passenger seat when it is unavoidable. (→P. 129)
- *5: In case the indicator is not illuminated, consult this manual for installing the child restraint system properly. (→P. 133)

CAUTION

■ Front passenger occupant classification system precautions

Observe the following precautions regarding front passenger occupant classification system.

Failure to do so may cause death or serious injury.

- Wear the seat belt properly.
- Make sure the front passenger's seat belt tab has not been left inserted into the buckle before someone sits in the front passenger seat.
- Make sure the AIR BAG OFF indicator light is not illuminated when using the seat belt extender for the front passenger seat. If the AIR BAG OFF indicator light is illuminated, disconnect the extender tongue from the seat belt buckle, then reconnect the seat belt. Reconnect the seat belt extender after making sure the AIR BAG ON indicator light is illuminated. If you use the seat belt extender while the AIR BAG OFF indicator light is illuminated, the SRS airbags for the passenger may not activate correctly, which could cause death or serious injury in the event of collision.
- Do not apply a heavy load to the front passenger seat or equipment (e.g. seatback pocket).
- Do not put weight on the front passenger seat by putting your hands or feet on the front passenger seat seatback from the rear passenger seat.
- Do not let a rear passenger lift the front passenger seat with their feet or press on the seatback with their legs.
- Do not put objects under the front passenger seat.

 CAUTION

■ Front passenger occupant classification system precautions

- Do not recline the front passenger seatback so far that it touches a rear seat. This may cause the AIR BAG OFF indicator light to be illuminated, which indicates that the passenger's airbags will not deploy in the event of a severe accident. If the seatback touches the rear seat, return the seatback to a position where it does not touch the rear seat. Keep the front passenger seatback as upright as possible when the vehicle is moving. Reclining the seatback excessively may lessen the effectiveness of the seat belt system.
- If an adult sits in the front passenger seat, the AIR BAG ON indicator light is illuminated. If the AIR BAG OFF indicator is illuminated, ask the passenger to sit up straight, well back in the seat, feet on the floor, and with the seat belt worn correctly. If the AIR BAG OFF indicator still remains illuminated, either ask the passenger to move to the rear seat, or if that is not possible, move the front passenger seat fully rearward.
- When it is unavoidable to install the forward-facing child restraint system on the front passenger seat, install the child restraint system on the front passenger seat in the proper order. (→P. 133)
- Do not modify or remove the front seats.
- Do not kick the front passenger seat or subject it to severe impact. Otherwise, the SRS warning light may come on to indicate a malfunction of the detection system. In this case, contact your Toyota dealer immediately.
- Child restraint systems installed on the rear seat should not contact the front seatbacks.
- Do not use a seat accessory, such as a cushion or seat cover, that covers the seat cushion surface.
- Do not modify or replace the upholstery of the front seat.

A child restraint system for a small child or baby must itself be properly restrained on the seat with the lap portion of the lap/shoulder belt.

The laws of all 50 states of the U.S.A. and Canada now require the use of child restraint systems.

Points to remember

Studies have shown that installing a child restraint on a rear seat is much safer than installing one to the front passenger seat.

- Choose a child restraint system that suits your vehicle and is appropriate to the age and size of the child.
- For installation details, follow the instructions provided with the child restraint system.

General installation instructions are provided in this manual.
(→P. 133)

Types of child restraint

Child restraint systems are classified into the following 3 types according to the age and size of the child.

- ▶ Rear facing — Infant seat/convertible seat

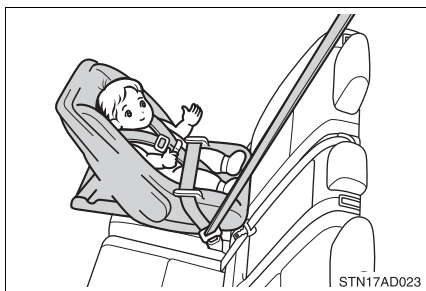

► Forward facing — Convertible seat

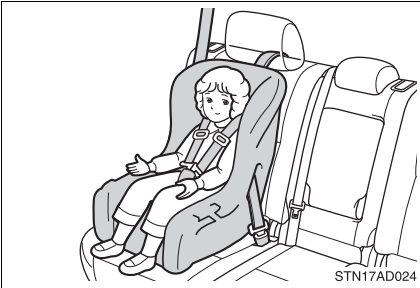

► Booster seat



■ **Selecting an appropriate child restraint system**

- Use a child restraint system appropriate for the child until the child becomes large enough to properly wear the vehicle's seat belts.
- If a child is too large for a child restraint system, sit the child on a rear seat and use the vehicle's seat belt. (→P. 69)

 CAUTION**■ Child restraint precautions**

- For effective protection in automobile accidents and sudden stops, a child must be properly restrained, using a seat belt or child restraint system depending on the age and size of the child. Holding a child in your arms is not a substitute for a child restraint system. In an accident, the child can be crushed against the windshield, or between you and the vehicle's interior.
- Toyota strongly urges the use of a proper child restraint system that conforms to the size of the child, installed on the rear seat. According to accident statistics, the child is safer when properly restrained in the rear seat than in the front seat.
- Never install a rear-facing child restraint system on the front passenger seat even if the AIR BAG OFF indicator light is illuminated.
In the event of an accident, the force of the rapid inflation of the front passenger airbag can cause death or serious injury to the child if the rear-facing child restraint system is installed on the front passenger seat.
- A forward-facing child restraint system may be installed on the front passenger seat only when it is unavoidable. A child restraint system that requires a top tether strap should not be used in the front passenger seat since there is no top tether strap anchor for the front passenger seat. Adjust the seatback as upright as possible and always move the seat as far back as possible even if the AIR BAG OFF indicator light is illuminated, because the front passenger airbag could inflate with considerable speed and force. Otherwise, the child may be killed or seriously injured.
- Do not use the seat belt extender when installing a child restraint system on the front or rear passenger seat. If installing a child restraint system with the seat belt extender connected to the seat belt, the seat belt will not securely hold the child restraint system, which could cause death or serious injury to the child or other passengers in the event of a sudden stop, sudden swerve or accident.
- Do not allow the child to lean his/her head or any part of his/her body against the door or the area of the seat, front and rear pillars or roof side rail from which the side airbags or curtain shield airbags deploy even if the child is seated in the child restraint system. It is dangerous if the side airbags and curtain shield airbags inflate, and the impact could cause death or serious injury to the child.

 CAUTION

■ **Child restraint precautions**

- Make sure you have complied with all installation instructions provided by the child restraint manufacturer and that the system is properly secured. If it is not secured properly, it may cause death or serious injury to the child in the event of a sudden stop, sudden swerve or accident.

■ **When children are in the vehicle**

Do not allow children to play with the seat belt. If the seat belt becomes twisted around a child's neck, it may lead to choking or other serious injuries that could result in death.

If this occurs and the buckle cannot be unfastened, scissors should be used to cut the belt.

■ **When the child restraint system is not in use**

- Keep the child restraint system properly secured on the seat even if it is not in use. Do not store the restraint unsecured in the passenger compartment.
- If it is necessary to detach the child restraint system, remove it from the vehicle or store it securely in the luggage compartment. This will prevent it from injuring passengers in the event of a sudden stop, sudden swerve or accident.

Installing child restraints

Follow the child restraint system manufacturer's instructions. Firmly secure child restraints to the rear seats using the LATCH anchors or a seat belt. Attach the top tether strap when installing a child restraint.

The lap/shoulder belt can be used if your child restraint system is not compatible with the LATCH (Lower Anchors and Tethers for Children) system.

■ Using the LATCH anchors

▶ Second seat (Separated seat)

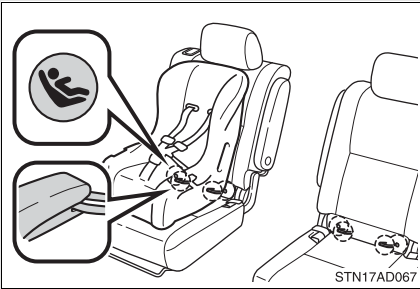

Child restraint LATCH anchors

LATCH anchors are provided for all of the second seats. (Buttons displaying the location of the anchors are attached to the seats.)

▶ Second seats (Bench seat)

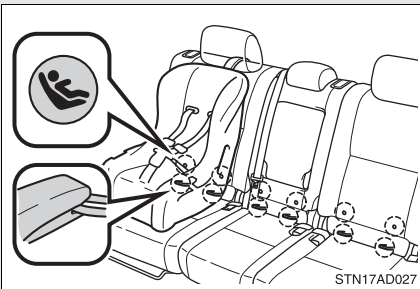

Child restraint LATCH anchors

LATCH anchors are provided for all of the second seats. (Buttons displaying the location of the anchors are attached to the seats.)

■ Using the seat belts

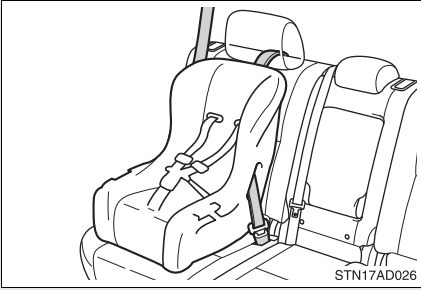

Seat belts equipped with a child restraint locking mechanism (ALR/ELR belts except driver's seat belt) (→P. 69)

■ Using the top tether strap

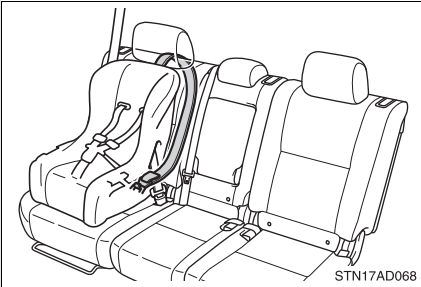

Anchor brackets
(for top tether strap)

▶ Second seats (Separated seat)

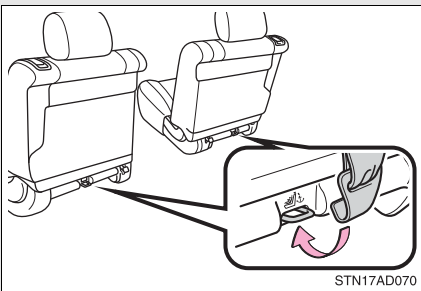

Anchor brackets are provided for all of the second seats.

► Second seats (Bench seat)

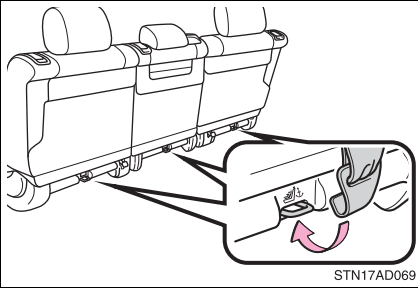

Anchor brackets are provided for all of the second seats.

► Third seats

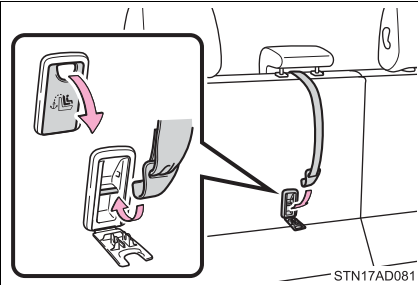

Anchor bracket is provided for the third center seat.

Installation with LATCH system (second seat only)

► Second seat (except center seat)

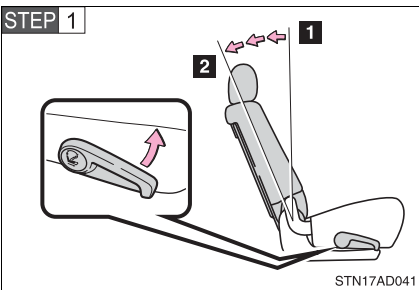

Fold the seatback while pulling the lever. Return the seatback and secure it at the 1st lock position (most upright position). Adjust the seatback to the 4th lock position. (→P. 51)

- 1 1st lock position
- 2 4th lock position

► Second center seat (bench seat)

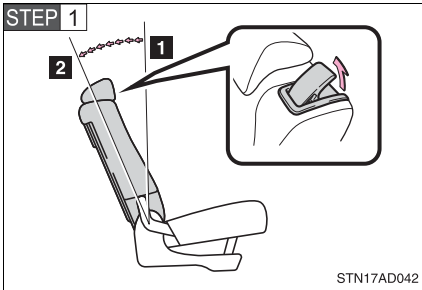

Fold the seatback while pulling the lever. Return the seatback and secure it at the 1st lock position (most upright position). Adjust the seatback to the 8th lock position. (→P. 51)

- 1 1st lock position
- 2 8th lock position

► Type A

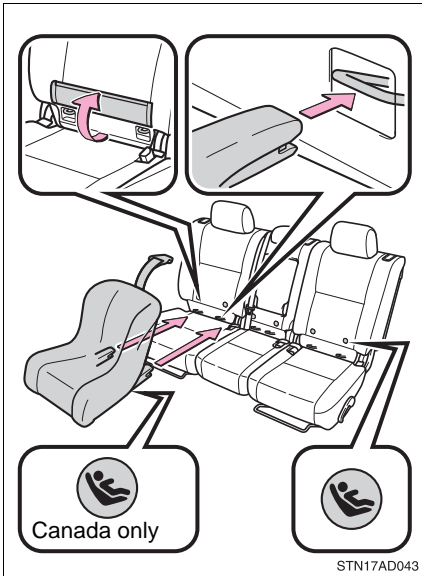

STEP 2 Latch the buckles onto the LATCH anchors.

The anchors are installed in the lower seatback under a flap. Confirm the position of the anchors below the symbol in the seatback.

STEP 3 If the child restraint has a top tether strap, the top tether strap should be latched onto the top tether strap anchor. (→P. 141)

For owners in Canada:
The symbol on a child restraint system indicates the presence of a lower connector system.

► Type B

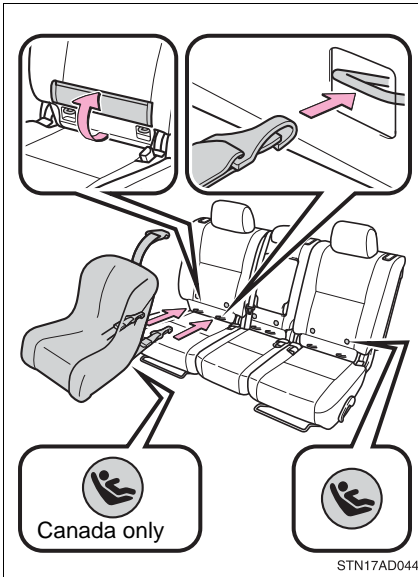

STEP 2 Latch the hooks of the lower straps onto the LATCH anchors and tighten the lower straps.

The anchors are installed in the lower seatback under a flap. Confirm the position of the anchors below the symbol in the seatback.

STEP 3 If the child restraint has a top tether strap, the top tether strap should be latched onto the top tether strap anchor. (→P. 141)

For owners in Canada:
The symbol on a child restraint system indicates the presence of a lower connector system.

Installing child restraints using a seat belt (child restraint lock function belt)

■ **Rear facing — Infant seat/convertible seat**

STEP 1

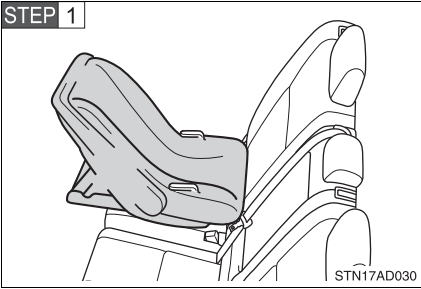

Place the child seat on the rear seat facing the rear of the vehicle.

STEP 2

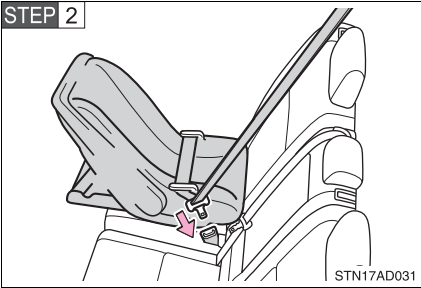

Run the seat belt through the child seat and insert the plate into the buckle. Make sure that the belt is not twisted.

STEP 3

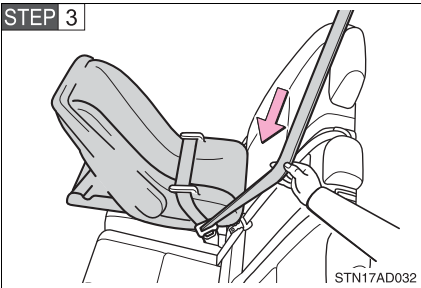

Fully extend the shoulder belt and then allow it to retract slightly in order to activate the ALR lock mode.

Lock mode allows the seat belt to retract only.

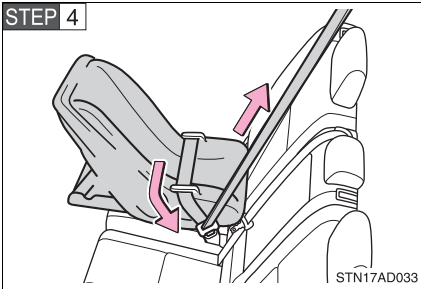

While pushing the child seat down into the rear seat, allow the shoulder belt to retract until the child seat is securely in place.

After the shoulder belt has retracted to a point where there is no slack in the belt, pull the belt to check that it cannot be extended.

■ Forward facing — Convertible seat

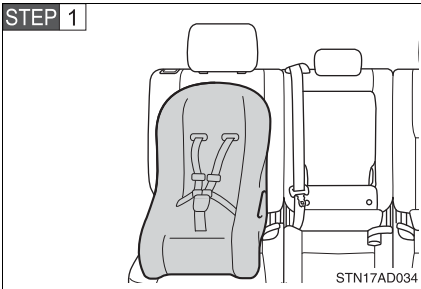

Place the child seat on the seat facing the front of the vehicle.

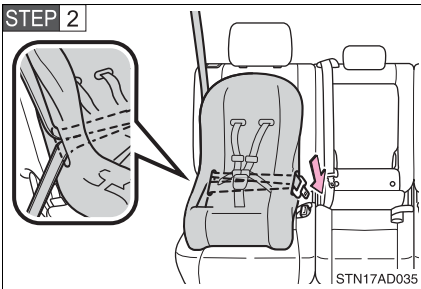

Run the seat belt through the child seat and insert the plate into the buckle. Make sure that the belt is not twisted.

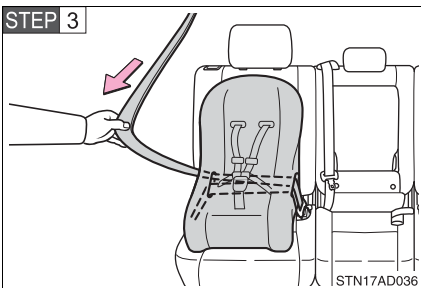

Fully extend the shoulder belt and then allow it to retract slightly in order to activate the ALR lock mode.

Lock mode allows the seat belt to retract only.

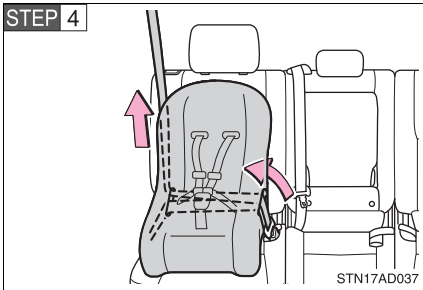

While pushing the child seat into the rear seat, allow the shoulder belt to retract until the child seat is securely in place.

After the shoulder belt has retracted to a point where there is no slack in the belt, pull the belt to check that it cannot be extended.

STEP 5 If the child restraint has a top tether strap, the top tether strap should be latched onto the top tether strap anchor. (→P. 141)

■ Booster seat

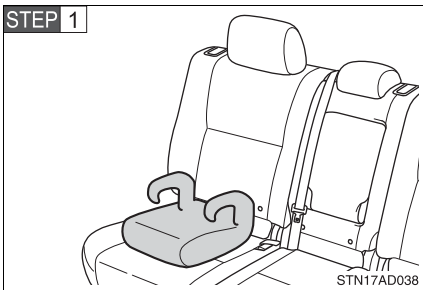

Place the booster seat on the seat facing the front of the vehicle.

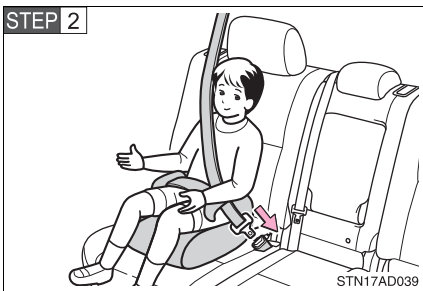

Sit the child in the booster seat. Fit the seat belt to the booster seat according to the manufacturer's instructions and insert the plate into the buckle. Make sure that the belt is not twisted.

Check that the shoulder belt is correctly positioned over the child's shoulder, and that the lap belt is as low as possible.

(→P. 69)

Removing a child restraint installed with a seat belt

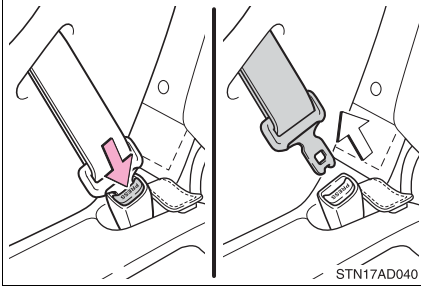

Push the buckle release button and fully retract the seat belt.

1

Before driving

Child restraint systems with a top tether strap

► Second seat

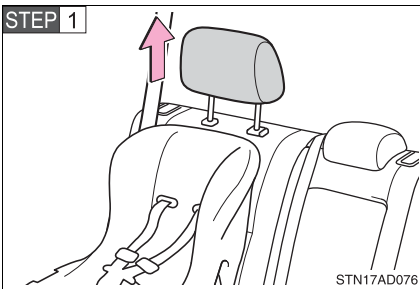

Secure the child restraint using the LATCH anchors or seat belt, and adjust the head restraint to the upmost position.

► Third center seat

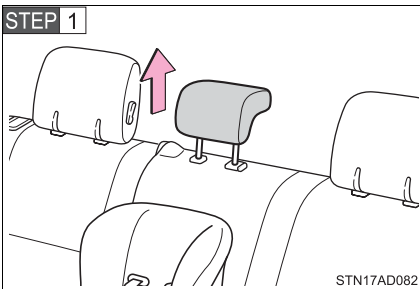

Secure the child restraint using the LATCH anchors or seat belt, and adjust the head restraint to the upmost position.

► Second seat

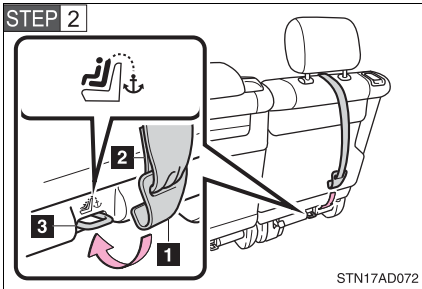

Latch the hook onto the anchor bracket and tighten the top tether strap.

Make sure the top tether strap is securely latched.

- 1 Hook
- 2 Top tether strap
- 3 Anchor bracket

► Third center seat

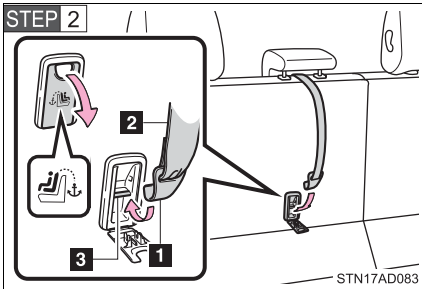

Open the anchor bracket cover. Latch the hook onto the anchor bracket and tighten the top tether strap.

Make sure the top tether strap is securely latched.

- 1 Hook
- 2 Top tether strap
- 3 Anchor bracket

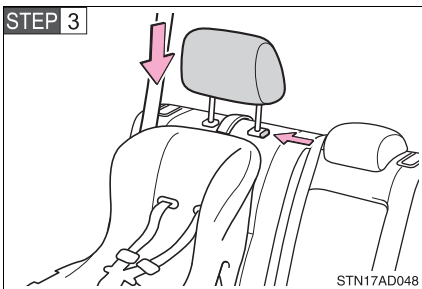

Adjust the head restraint to the downmost position.

■ Laws and regulations pertaining to anchorages

The LATCH system conforms to FMVSS225 or CMVSS210.2.

Child restraint systems conforming to FMVSS213 or CMVSS213 specifications can be used.

This vehicle is designed to conform to the SAE J1819.

⚠ CAUTION

■ When installing a booster seat

Do not fully extend the shoulder belt to prevent the belt from going to ALR lock mode. (→P. 74)

ALR mode causes the belt to tighten only which could cause injury or discomfort to the child.

■ When installing a child restraint system

Follow the directions given in the child restraint system installation manual and fix the child restraint system securely in place.

If the child restraint system is not correctly fixed in place, the child or other passengers may be seriously injured or even killed in the event of sudden braking, sudden swerving or an accident.

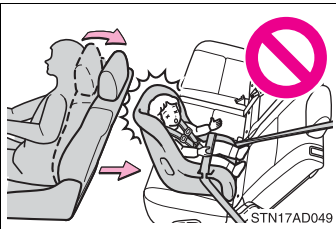

- If the driver's seat interferes with the child restraint system and prevents it from being attached correctly, attach the child restraint system to the right-hand rear seat.
- Adjust the front passenger seat so that it does not interfere with the child restraint system.

⚠ CAUTION

■ When installing a child restraint system

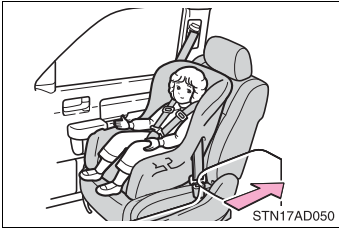

● Only put a forward-facing or booster child seat on the front seat when unavoidable. When installing a forward-facing or booster child seat on the front passenger seat, move the seat as far back as possible even if the AIR BAG OFF indicator light is illuminated. Failing to do so may result in death or serious injury if the airbags deploy (inflate).

- When installing a child restraint system in the center third seat, adjust both seatbacks at the same angle. The seatbacks must be adjusted to the same angle. Otherwise, the child restraint system cannot be securely restrained and this may cause death or serious injuries in the event of sudden braking, sudden swerving or an accident.
- When a booster seat is installed, always ensure that the shoulder belt is positioned across the center of the child's shoulder. The belt should be kept away from the child's neck, but not so that it could fall off the child's shoulder. Failing to do so may result in death or serious injury in the event of sudden braking, sudden swerving or an accident.
- Ensure that the belt and tab are securely locked and the seat belt is not twisted.
- Push and pull the child restraint system from side to side and forward to be sure it is secure.
- After securing a child restraint system, never adjust the seat.
- Follow all installation instructions provided by the child restraint system manufacturer.
- When securing some types of child restraint systems in second or third row seats, it may not be possible to properly use the seat belts in positions next to the child restraint without interfering with it or affecting seat belt effectiveness. Be sure your seat belt fits snugly across your shoulder and low on your hips. If it does not, or if it interferes with the child restraint, move to a different position. Failure to do so may result in death or serious injury.

 **CAUTION****■ When installing a child restraint system (vehicles with bench type second seat)**

Observe the following precautions.

Failure to do so may cause death or serious injury to the child or other passengers in the event of a sudden stop or accident.

- When installing the child restraint system onto the second center seat, secure it so as not interfere with the front console box.
- Do not change the posture and position of the outside second seat once the child restraint system has been secured to the second center seat.

■ Do not use a seat belt extender

If a seat belt extender is used when installing a child restraint system, the seat belt will not securely hold the child restraint system, which could cause death or serious injury to the child or other passengers in the event of sudden braking, sudden swerving or an accident.

■ To correctly attach a child restraint system to the anchors

When using the LATCH anchors, be sure that there are no foreign objects around the anchors and that the seat belt is not caught behind the child restraint. Make sure the child restraint system is securely attached, or it may cause death or serious injury to the child or other passengers in the event of a sudden stop, sudden swerve or accident.

2-1. Driving procedures

Driving the vehicle.....	148
Engine (ignition) switch	158
Automatic transmission....	161
Turn signal lever	165
Parking brake.....	166
Horn	167

2-2. Instrument cluster

Gauges and meters	168
Indicators and warning lights	173
Multi-information display.....	178
Accessory meter	184

2-3. Operating the lights and wipers

Headlight switch.....	187
Fog light switch	193
Windshield wipers and washer	195
Rear window wiper and washer	199
Headlight cleaner switch.....	201

2-4. Using other driving systems

Cruise control.....	202
Dynamic laser cruise control	206
Intuitive parking assist.....	220
BSM (Blind Spot Monitor)	227
Electronically modulated air suspension.....	233
AVS (Adaptive Variable Suspension System).....	238
Four-wheel drive system	239
AUTO LSD system.....	244
Driving assist systems	246

2-5. Driving information

Off-road precautions	254
Cargo and luggage	259
Vehicle load limits	264
Winter driving tips	266
Trailer towing	270
Dinghy towing	290

2-1. Driving procedures

Driving the vehicle

The following procedures should be observed to ensure safe driving.

■ Starting the engine (→P. 158)

■ Driving

STEP 1 With the brake pedal depressed, shift the shift lever to D. (→P. 161)

STEP 2 Release the parking brake. (→P. 166)

STEP 3 Gradually release the brake pedal and gently depress the accelerator pedal to accelerate the vehicle.

■ Stopping

STEP 1 With the shift lever in D, depress the brake pedal.

STEP 2 If necessary, set the parking brake.

When the vehicle is stopped for an extended period of time, shift the shift lever to P or N. (→P. 161)

■ Parking the vehicle

STEP 1 With the shift lever in D, depress the brake pedal.

STEP 2 Set the parking brake. (→P. 166)

STEP 3 Shift the shift lever to P. (→P. 161)

When parking on a hill, if necessary, block the wheels.

STEP 4 Turn the engine switch off to stop the engine.

STEP 5 Lock the door, making sure that you have the key on your person.

Starting on a steep uphill

STEP 1 With the brake pedal depressed, firmly set the parking brake and shift the shift lever to D.

STEP 2 Gently depress the accelerator pedal.

STEP 3 Release the parking brake.

■ Driving in the rain

- Drive carefully when it is raining, because visibility will be reduced, the windows may become fogged-up, and the road will be slippery.
- Drive carefully when it starts to rain, because the road surface will be especially slippery.
- Refrain from high speeds when driving on an expressway in the rain, because there may be a layer of water between the tires and the road surface, preventing the steering and brakes from operating properly.

■ Engine speed while driving

In the following conditions, the engine speed may become high while driving. This is due to automatic up-shifting control or down-shifting implementation to meet driving conditions. It does not indicate sudden acceleration.

- The vehicle is judged to be driving uphill or downhill
- When the accelerator pedal is released
- When the brake pedal is depressed while S mode is selected

■ Breaking in your new Toyota

To extend the life of the vehicle, the following precautions are recommended to observe:

- For the first 200 miles (300 km):
Avoid sudden stops.
- For the first 500 miles (800 km):
Do not tow a trailer.
- For the first 1000 miles (1600 km):
 - Do not drive at extremely high speeds.
 - Avoid sudden acceleration.
 - Do not drive continuously in the low gears.
 - Do not drive at a constant speed for extended periods.

■ Drum-in-disc type parking brake system

Your vehicle has a drum-in-disc type parking brake system. This type of brake system needs bedding-down of the brake shoes periodically or whenever the parking brake shoes and/or drum are replaced. Have your Toyota dealer perform the bedding down operation.

■ Operating your vehicle in a foreign country

Comply with the relevant vehicle registration laws and confirm the availability of the correct fuel. (→P. 515)

■ When turning off the engine

The emission system operating sounds may continue for a short time after the engine is turned off. This is not a malfunction, and helps to ensure optimal performance of the emission system.

CAUTION

■ When starting the vehicle

Always keep your foot on the brake pedal while stopped with the engine running. This prevents the vehicle from creeping.

■ When driving the vehicle

- Do not drive if you are unfamiliar with the location of the brake and accelerator pedals to avoid depressing the wrong pedal.
 - Accidentally depressing the accelerator pedal instead of the brake pedal will result in sudden acceleration that may lead to an accident that could result in death or serious injury.
 - When backing up, you may twist your body around, leading to a difficulty in operating the pedals. Make sure to operate the pedals properly.
 - Make sure to keep a correct driving posture even when moving the vehicle only slightly, allowing you to depress the brake and accelerator pedals properly.
 - Depress the brake pedal using your right foot. Depressing the brake pedal using your left foot may delay response in an emergency, resulting in an accident.
- Do not drive the vehicle over or stop the vehicle near flammable materials. The exhaust system and exhaust gases can be extremely hot. This may cause a fire if there is any flammable material nearby.
- Do not let the vehicle roll backwards while the shift lever is in a driving position, or roll forward while the shift lever is in R. Doing so may cause the engine to stall or lead to poor brake and steering performance, resulting in an accident or damage to the vehicle.

 CAUTION

■ When driving the vehicle

- If the smell of exhaust is noticed inside the vehicle, open the windows and check that the back door and power back window are closed. Large amounts of exhaust in the vehicle can cause driver drowsiness and an accident, resulting in death or a serious health hazard. Have the vehicle inspected by your Toyota dealer immediately.
- Do not shift the shift lever to P while the vehicle is moving.
Doing so can damage the transmission and may result in a loss of vehicle control.
- Do not shift the shift lever to R while the vehicle is moving forward.
Doing so can damage the transmission and may result in a loss of vehicle control.
- Do not shift the shift lever to a driving position while the vehicle is moving backward.
Doing so can damage the transmission and may result in a loss of vehicle control.
- Moving the shift lever to N while the vehicle is moving will disengage the engine from the transmission. Engine braking is not available when N is selected.
- During normal driving, do not turn off the engine. Turning the engine off while driving will not cause loss of steering or braking control, but the power assist to these systems will be lost. This will make it more difficult to steer and brake, so you should pull over and stop the vehicle as soon as it is safe to do so.
However, in the event of an emergency, such as if it becomes impossible to stop the vehicle in the normal way: →P. 509
- Use engine braking (downshift) to maintain a safe speed when driving down a steep hill.
Using the brakes continuously may cause the brakes to overheat and lose effectiveness. (→P. 161)
- When stopped on an inclined surface, use the brake pedal and parking brake to prevent the vehicle from rolling backward or forward and causing an accident.

 CAUTION

■ **When driving the vehicle**

- Do not adjust the position of the steering wheel, the seat, or the inside or outside rear view mirrors while driving.
Doing so may result in a loss of vehicle control that can cause accidents that may result in death or serious injury.
- Always check that all passengers' arms, heads or other parts of their bodies are not outside the vehicle, as this may result in death or serious injury.
- Do not drive in excess of the speed limit. Even if the legal speed limit permits it, do not drive over 85 mph (140 km/h) unless your vehicle has high-speed capability tires. Driving over 85 mph (140 km/h) may result in tire failure, loss of control and possible injury. Be sure to consult a tire dealer to determine whether the tires on your vehicle are high-speed capability tires or not before driving at such speeds.
- If you drive through deep water over about 20 in. (500 mm) in depth, put the vehicle height in the HI mode using the height control switch and then change to manual mode by pushing the height control mode select switch. Drive your vehicle at 18 mph (30 km/h) or less. Do not drive through water deeper than about 28 in. (700 mm) even if the vehicle height is in "HI" mode.

■ **When driving on slippery road surfaces**

- Sudden braking, acceleration and steering may cause tire slippage and reduce your ability to control the vehicle, resulting in an accident.
- Sudden changes in engine speed, such as engine braking caused by up-shifting or down-shifting, may cause the vehicle to skid, resulting in an accident.
- After driving through a puddle, lightly depress the brake pedal to make sure that the brakes are functioning properly. Wet brake pads may prevent the brakes from functioning properly. If the brakes on only one side are wet and not functioning properly, steering control may be affected, resulting in an accident.

■ **When shifting the shift lever**

- Be careful not to shift the shift lever with the accelerator pedal depressed. This may lead to unexpected rapid acceleration of the vehicle that may cause an accident and result in death or serious injury.

 CAUTION

■ When the vehicle is stopped

- Do not race the engine.
If the vehicle is in any gear other than P or N, the vehicle may accelerate suddenly and unexpectedly, and may cause an accident.
- Do not leave the vehicle with the engine running for a long time.
If such a situation cannot be avoided, park the vehicle in an open space and check that exhaust fumes do not enter the vehicle interior.
- In order to prevent accidents due to the vehicle rolling away, always keep depressing the brake pedal while the engine is running, and apply the parking brake as necessary.
- If the vehicle is stopped on an incline, in order to prevent accidents caused by the vehicle rolling forward or backward, always depress the brake pedal and securely apply the parking brake as needed.
- Avoid revving or racing the engine.
Running the engine at high speed while the vehicle is stopped may cause the exhaust system to overheat, which could result in a fire if combustible material is nearby.

■ When the vehicle is parked

- Do not leave glasses, cigarette lighters, spray cans, or soft drink cans in the vehicle when it is in the sun.
Doing so may result in the following.
 - Gas may leak from a cigarette lighter or spray can, and may lead to a fire.
 - The temperature inside the vehicle may cause the plastic lenses and plastic material of eye glasses to deform or crack.
 - Soft drink cans may rupture, causing the contents to spray over the interior of the vehicle, and may also cause a short circuit in the vehicle's electrical components.
- Always apply the parking brake, shift the shift lever to P, stop the engine and lock the vehicle.
Do not leave the vehicle unattended while the engine is running.

 **CAUTION**

■ **When the vehicle is parked**

- If the shift lever is moved before the 4LO indicator turns on/off, the transfer mode may not be shifted completely. The transfer mode disengages both the front and rear driveshafts from the powertrain and allows the vehicle to move regardless of the shift position. (At this time, the indicator blinks and the buzzer sounds.)

Therefore, the vehicle is free to roll even if the automatic transmission is in P. You or someone else could be seriously injured. You must complete the shifting of the transfer mode. (→P. 239)

- Do not touch the exhaust pipe while the engine is running or immediately after turning the engine off.
Doing so may cause burns.
- Do not leave the engine running in an area with snow build-up, or where it is snowing. If snowbanks build up around the vehicle while the engine is running, exhaust gases may collect and enter the vehicle. This may lead to death or a serious health hazard.

■ **Exhaust gases**

Exhaust gases include harmful carbon monoxide (CO) that is colorless and odorless. Inhaling exhaust gases may lead to death or a serious health hazard.

- If the vehicle is in a poorly ventilated area, stop the engine. In a closed area, such as a garage, exhaust gases may collect and enter the vehicle. This may lead to death or a serious health hazard.
- The exhaust should be checked occasionally. If there is a hole or crack caused by corrosion, damage to a joint or abnormal exhaust noise, be sure to have the vehicle inspected and repaired by your Toyota dealer. Failure to do so may allow exhaust gases to enter the vehicle, resulting in death or a serious health hazard.

 **CAUTION****■ When taking a nap in the vehicle**

Always turn the engine off. Otherwise, you may accidentally move the shift lever or depress the accelerator pedal, which could cause an accident or fire due to engine overheating. Additionally, if the vehicle is parked in a poorly ventilated area, exhaust gases may collect and enter the vehicle, leading to death or a serious health hazard.

■ When braking the vehicle

- When the brakes are wet, drive more cautiously.
Braking distance increases when the brakes are wet, and may cause one side of the vehicle to brake differently than the other side. Also the parking brake may not securely hold the vehicle.
- If the power brake assist function does not operate, do not follow other vehicles closely and avoid downhills or sharp turns that require braking.
In this case, braking is still possible, but it will require more force on the pedal than usual. Braking distance may also increase. Have your brakes fixed immediately.
- Do not pump the brake pedal if the engine stalls.
Each push on the brake pedal uses up the reserve for the power-assisted brakes.
- The brake system consists of 2 individual hydraulic systems: If one of the systems fails, the other will still operate. In this case, the brake pedal should be depressed more firmly than usual and braking distance becomes longer.
Have your brakes fixed immediately.

 NOTICE

■ **When driving the vehicle**

- Do not depress the accelerator and brake pedals at the same time during driving, as this may restrain driving torque.
- Do not use the accelerator pedal or depress the accelerator and brake pedals at the same time to hold the vehicle on a hill.

■ **When parking the vehicle**

Always put the shift lever in P.

Failure to do so may cause the vehicle to move or the vehicle may accelerate suddenly if the accelerator pedal is accidentally depressed.

■ **Avoiding damage to vehicle parts**

- Do not turn the steering wheel fully in either direction and hold it there for a long time.
Doing so may damage the power steering pump.
- When driving over bumps in the road, drive as slowly as possible to avoid damaging the wheels, underside of the vehicle, etc.

■ **If you hear a squealing or scraping noise while driving (brake pad wear limit indicators)**

Have the brake pads checked and replaced by your Toyota dealer as soon as possible.

The rotor damage can result if the pads are not replaced when needed.

It is dangerous to drive the vehicle when the wear limits of the brake pads and/or that of the brake discs are exceeded.

■ **If you get a flat tire while driving**

A flat or damaged tire may cause the following situations. Hold the steering wheel firmly and gradually press the brake pedal to slow down the vehicle.

- It may be difficult to control your vehicle.
- The vehicle will make abnormal sounds.
- The vehicle will behave abnormally.

Replace a flat tire with a new one. (→P. 486)

**NOTICE****■ When encountering flooded roads**

Do not drive on a road that has flooded after heavy rain etc. Doing so may cause the following serious damage to the vehicle.

- Engine stalling
- Short in electrical components
- Engine damage caused by water immersion

In the event that you drive on a flooded road and the vehicle is flooded, be sure to have your Toyota dealer check the following.

- Brake function
- Changes in quantity and quality of oil and fluid used for the engine, transmission, transfer (4WD models), differentials, etc.
- Lubricant condition for the propeller shaft, bearings and suspension joints (where possible) and the function of all joints, bearings, etc.

Engine (ignition) switch

■ Engine switch

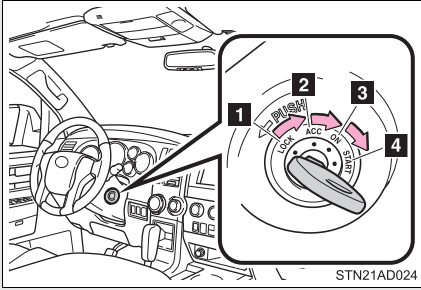

1 LOCK

The steering wheel is locked and the key can be removed. (The key can be removed only when the shift lever is in P.)

2 ACC

Some electrical components such as the audio system can be used.

3 ON

All electrical components can be used.

4 START

For starting the engine.

■ Starting the engine

STEP 1 Check that the parking brake is set.

STEP 2 Check that the shift lever is set in P.

STEP 3 Sit in the driver's seat and firmly depress the brake pedal.

STEP 4 Turn the engine switch to the START position and start the engine.

The engine will crank until it starts or for up to 25 seconds, whichever is less. If you turn the engine switch, the engine will keep cranking for about 30 seconds maximum.

Continue depressing the brake pedal until the engine is completely started.

■ Turning the key from ACC to LOCK

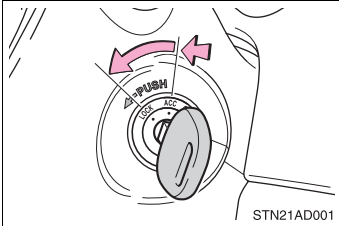

STEP 1 Shift the shift lever to P.
(→P. 161)

STEP 2 Push in the key and turn to the LOCK position.

■ Steering lock release

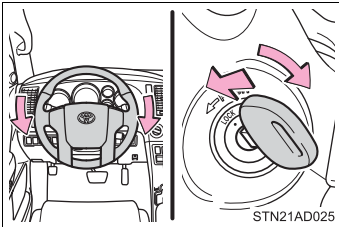

When starting the engine, the engine switch may seem stuck in the LOCK position. To free it, turn the key while turning the steering wheel slightly in either direction.

■ If the engine does not start

The engine immobilizer system may not have been deactivated. (→P. 105)

■ Key reminder function

A buzzer sounds if the driver's door is opened, while the engine switch is in the ACC or LOCK position to remind you to remove the key.

⚠ CAUTION

■ When starting the engine

Always start the engine while sitting in the driver's seat. Do not depress the accelerator while starting the engine under any circumstances. Doing so may cause an accident resulting in death or serious injury.

■ Caution while driving

Do not turn the engine switch to the LOCK position. If in an emergency, you must turn the engine off while the vehicle is moving, turn the engine switch only to the ACC position.



NOTICE

■ To prevent battery discharge

Do not leave the engine switch in the ACC or ON position for long periods if the engine is not running.

■ When starting the engine

- Do not crank for more than 30 seconds at a time. This may overheat the starter and wiring systems.
- Do not race a cold engine.
- If the engine becomes difficult to start or stalls frequently, have the engine checked immediately.

2-1. Driving procedures

Automatic transmission

Select a shift position appropriate for the driving conditions.

■ Shifting the shift lever

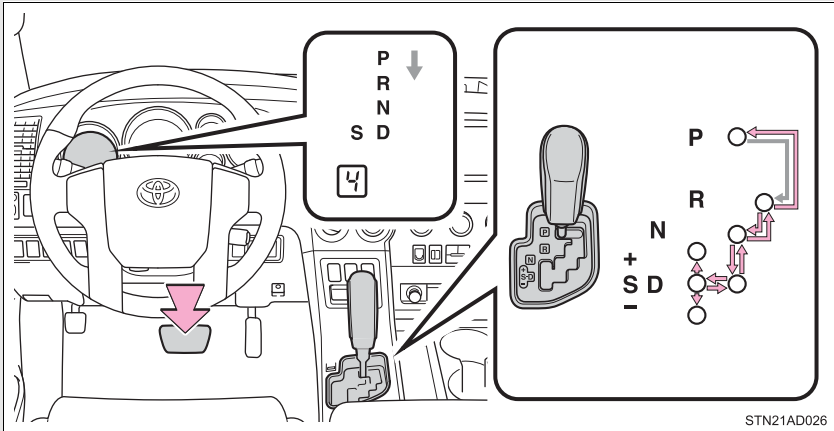

← While the engine switch is on, depress the brake pedal and move the shift lever.

■ Shift position uses

Shift position	Function
P	Parking the vehicle or starting the engine
R	Reversing
N	Neutral
D	Normal driving ^{*1}
S	S mode driving ^{*2} (→P. 162)

*1: To improve fuel consumption and reduce noises, set the shift lever in D for normal driving.

*2: Selecting shift ranges S mode restricts the upper limit of the possible gear ranges, control engine braking forces, and prevents unnecessary upshifting.

Changing shift ranges in S mode

Shift the shift lever to the S position and operate the shift lever.

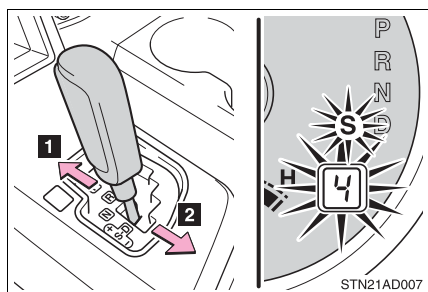

- 1 Upshifting
- 2 Downshifting

The initial shift range in S mode is automatically set to 5 or 4 according to vehicle speed. However, the initial shift range may be set to 3 or 2 if the AI-SHIFT has operated while the shift lever was in the D position. (→P. 163)

Shift ranges and their functions

Shift range	Function
6	Automatically selecting gears between 1 and 6 according to vehicle speed and driving conditions.
5	Automatically selecting gears between 1 and 5 according to vehicle speed and driving conditions.
4	Automatically selecting gears between 1 and 4 according to vehicle speed and driving conditions.
3	Automatically selecting gears between 1 and 3 according to vehicle speed and driving conditions.
2	Automatically selecting gears between 1 and 2 according to vehicle speed and driving conditions.
1	Setting the gear at 1.

A lower shift range will provide greater engine braking forces than a higher shift range.

TOW/HAUL switch (with towing package)

Use TOW/HAUL mode when pulling a trailer or hauling a heavy load.

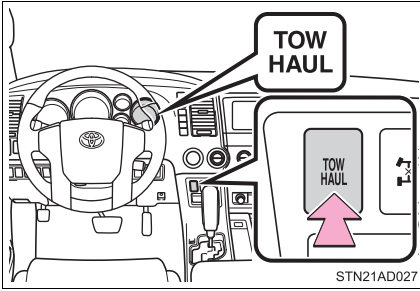

Press the TOW/HAUL switch. The indicator will come on.

Press the switch once more to cancel the mode.

■ Gear range display when driving in S mode

The current gear range is displayed on the combination meter. (→P. 162)

■ When driving with the cruise control system

The engine brake will not operate in the S mode, even when downshifting to 5 or 4. (→P. 202, 206)

■ If the shift lever cannot be shifted from P

→P. 499

■ If the S indicator does not come on even after shifting the shift lever to S

This may indicate a malfunction in the automatic transmission system. Have the vehicle inspected by your Toyota dealer, immediately.

(In this situation, the vehicle will operate as if the shift lever is in D.)

■ AI-SHIFT

The AI-SHIFT automatically shifts the gear to the suitable position according to the driver performance and driving conditions.

The AI-SHIFT automatically operates when the shift lever is in the D position. (Shifting the shift lever to the S position cancels the function.)

■ **Downshifting restrictions warning buzzer (in the S mode)**

To help ensure safety and driving performance, downshifting operation may sometimes be restricted. In some circumstances, downshifting may not be possible even when the shift lever is operated. (The warning buzzer will sound twice.)

■ **Transmission protection function**

If the tires spin continually when the vehicle becomes stuck in mud, dirt or snow, the automatic transmission temperature may become too high and cause damage.

To avoid the damaging the automatic transmission, the system may temporarily lock the gear in 1st.

If the automatic transmission temperature falls, the gear locking is canceled and returns the automatic transmission to the normal operation.

2-1. Driving procedures

Turn signal lever

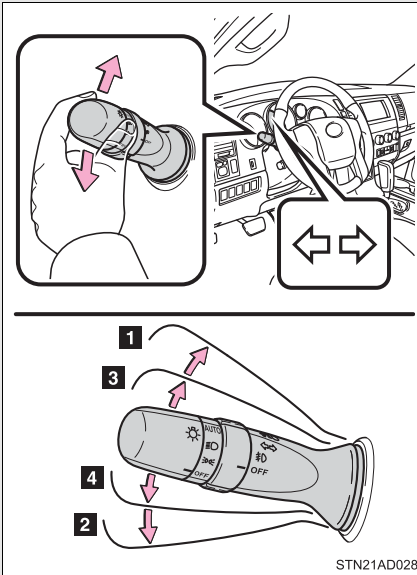

- 1 Right turn
- 2 Left turn
- 3 Move and hold the lever partway to signal a lane change.

The right hand signal will flash until you release the lever.

- 4 Move and hold the lever partway to signal a lane change.

The left hand signal will flash until you release the lever.

2

When driving

■ Turn signals can be operated when

The engine switch is in the ON position.

■ If the indicators flash faster than usual

Check that a light bulb in the front or rear turn signal lights has not burned out.

Parking brake

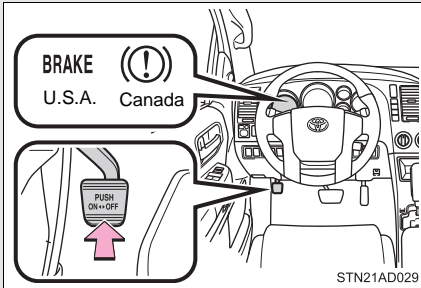

Set the parking brake*.
(Depressing the pedal again releases the parking brake.)

At this time, the indicator will come on.

*: Fully depress the parking brake pedal with your left foot while depressing the brake pedal with your right foot.

■ Parking brake engaged warning buzzer

The buzzer sounds to indicate that parking brake is still engaged (with the vehicle having reached a speed of 3 mph [5 km/h]).

■ Usage in winter time

See "Winter driving tips" for parking brake usage in winter time. (→P. 266)

⚠ NOTICE

■ Before driving

Fully release the parking brake.

Driving the vehicle with the parking brake set will lead to brake components overheating, which may affect braking performance and increase brake wear.

Horn

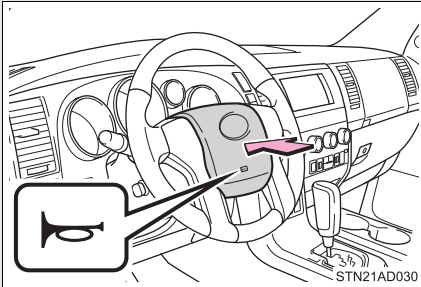

To sound the horn, press on or close to the  mark.

■ **After adjusting the steering wheel (vehicles with manual tilt and telescopic steering)**

Make sure that the steering wheel is securely locked.

The horn may not sound if the steering wheel is not securely locked.

(→P. 79)

2-2. Instrument cluster Gauges and meters

► Vehicles with multi-information display

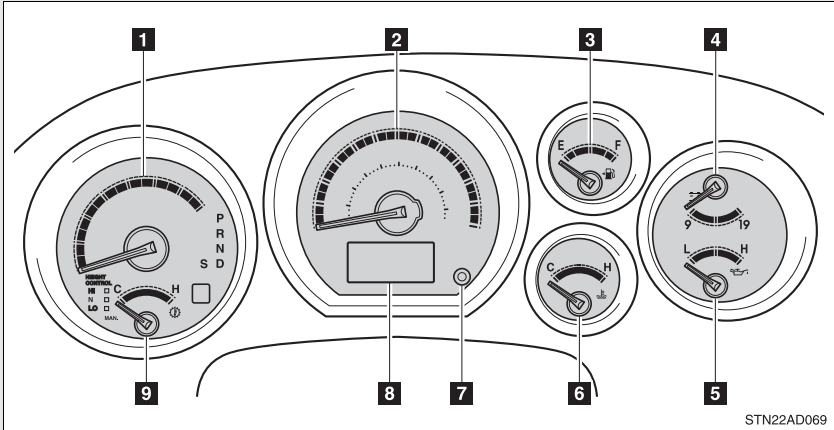

The following gauges, meters and displays illuminate when the engine switch is in the ON position.

1 Tachometer

Displays the engine speed in revolutions per minute.

2 Speedometer

Displays the vehicle speed.

3 Fuel gauge

Displays the quantity of fuel remaining in the tank.

4 Voltmeter

Displays the charge state.

5 Engine oil pressure gauge

Displays the engine oil pressure.

6 Engine coolant temperature gauge

Displays the engine coolant temperature.

7 Odometer/trip meter switching and trip meter resetting button

Switches between odometer and trip meter displays. Pushing and holding the button will reset the trip meter when the trip meter is being displayed.

8 Multi-information display

→P. 178

9 Automatic transmission fluid temperature gauge

Displays the automatic transmission fluid temperature.

► Vehicles without multi-information display

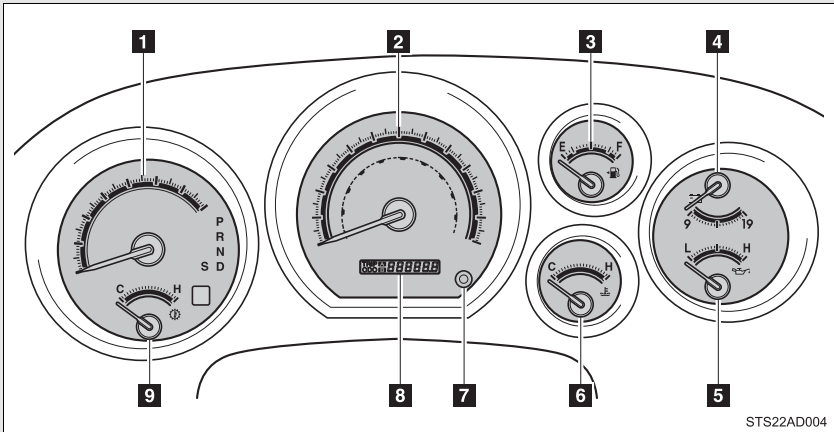

The following gauges, meters and displays illuminate when the engine switch is in the ON position.

1 Tachometer

Displays the engine speed in revolutions per minute.

2 Speedometer

Displays the vehicle speed.

3 Fuel gauge

Displays the quantity of fuel remaining in the tank.

4 Voltmeter

Displays the charge state.

5 Engine oil pressure gauge

Displays the engine oil pressure.

6 Engine coolant temperature gauge

Displays the engine coolant temperature.

7 Odometer/trip meter switching and trip meter resetting button

Switches between odometer and trip meter displays. Pushing and holding the button will reset the trip meter when the trip meter is being displayed.

8 Odometer/trip meter

Odometer:

Displays the total distance the vehicle has been driven.

Trip meter:

Displays the distance the vehicle has been driven since the meter was last reset. Trip meters A and B can be used to record and display different distances independently.

9 Automatic transmission fluid temperature gauge (if equipped)

Displays the automatic transmission fluid temperature.

2

When driving

Odometer and trip meter display button

Pressing this button switches between odometer and trip meter displays.

▶ Vehicles with multi-information display

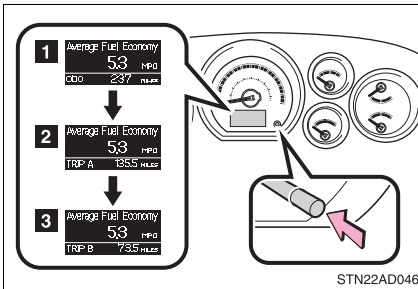
**1 Odometer****2 Trip meter A*****3 Trip meter B***

*: Pushing and holding the button will reset the trip meter.

▶ Vehicles without multi-information display

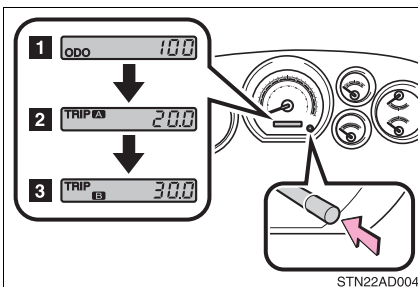
**1 Odometer****2 Trip meter A*****3 Trip meter B***

*: Pushing and holding the button will reset the trip meter.

Instrument panel light control

The brightness of the instrument panel lights can be adjusted.

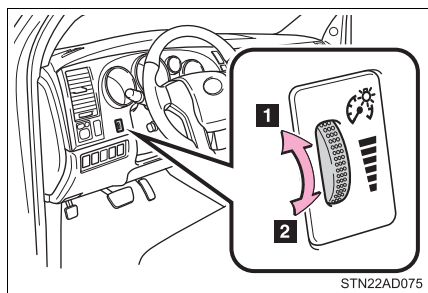

1 Brighter

2 Darker

► Vehicles with multi-information display

With the dial turned fully up, the intensity of the instrument panel lights will not be reduced even when the tail lights/headlights are turned on.

NOTICE

■ To prevent damage to the engine and its components

- Do not let the indicator needle of the tachometer enter the red zone, which indicates the maximum engine speed.
- The engine may be overheating if the engine coolant temperature gauge is in the red zone (H). In this case, immediately stop the vehicle in a safe place, and check the engine after it has cooled completely. (→P. 504)

■ While driving

- When the voltmeter indicates more than 19 V or less than 9 V, the battery may be malfunctioning. Have your vehicle checked at your Toyota dealer.
- When the engine oil pressure gauge does not work properly, immediately stop the engine and contact your Toyota dealer.
- When the automatic transmission fluid temperature gauge needle continually points higher than normal, immediately contact your Toyota dealer. (if equipped)

Indicators and warning lights

The indicator and warning lights on the instrument cluster and center panel inform the driver of the status of the vehicle's various systems.

► Instrument cluster (vehicles with multi-information display)

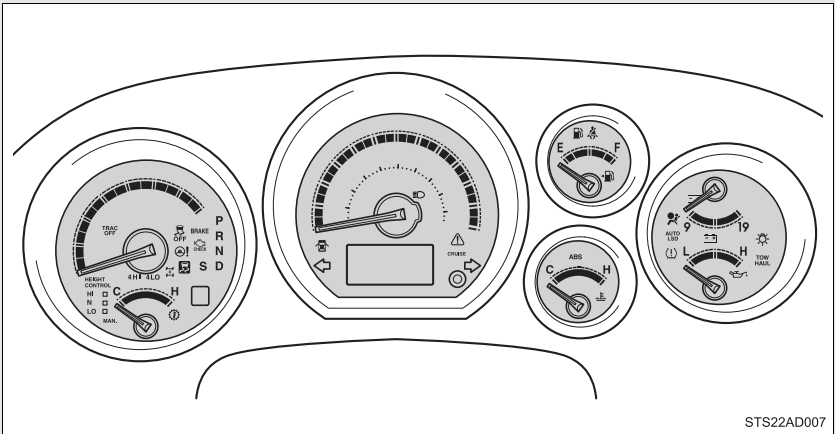

► Instrument cluster (vehicles without multi-information display)

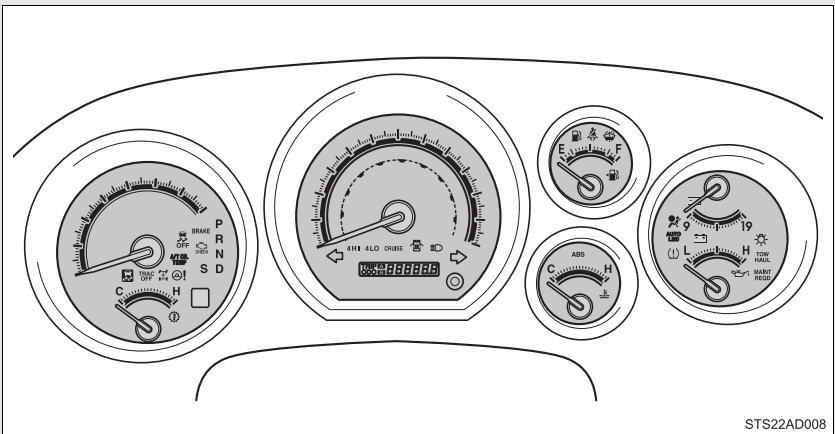

► Center panel

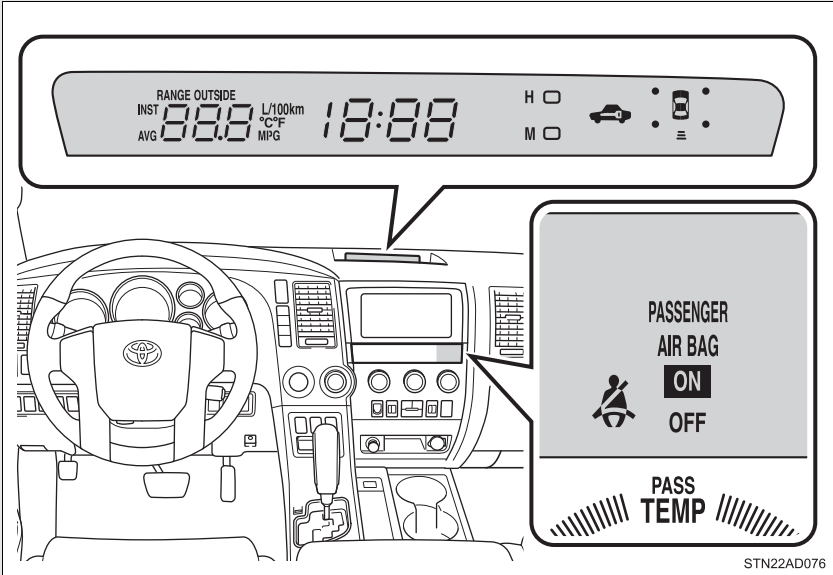

► Outside rear view mirrors [vehicles with BSM (Blind Spot Monitor)]

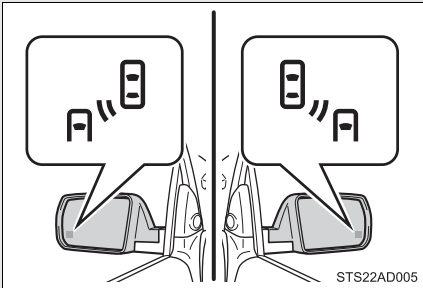

■ Indicators

The indicators inform the driver of the operating state of the vehicle's various systems.



Turn signal indicator
(→P. 165)



Headlight high beam indicator (→P. 191)



Security indicator
(→P. 105, 107)



Shift position and shift range indicators
(→P. 161)



Cruise control indicator
(→P. 202, 206)



Slip indicator
(→P. 245, 247)



VSC OFF indicator
(→P. 244, 247, 249, 250)



(If equipped)

BSM outside rear view mirror indicators
(→P. 227)



(U.S.A.)

Headlight indicator
(→P. 187)



(Canada)

Tail light indicator
(→P. 187)



AUTO LSD indicator
(→P. 244, 247)



(4WD models)

Center differential lock indicator
(→P. 240)



TRAC OFF indicator
(→P. 247, 249, 250)



AIR BAG ON indicator
(→P. 124)



AIR BAG OFF indicator
(→P. 124)



(4WD models)

4HI indicator (→P. 239)



(4WD models)

4LO indicator (→P. 239)





(If equipped)

TOW HAUL indicator
(→P. 163)

HI  *1,2
Height control HI indicator (→P. 233)

MAN.  *1,2
Height control MAN. indicator (→P. 234)

N  *1,2
Height control N indicator (→P. 233)

LO  *1,2
Height control LO indicator (→P. 233)

■ Warning lights

Warning lights inform the driver of malfunctions in any of the vehicle's systems. (→P. 469)

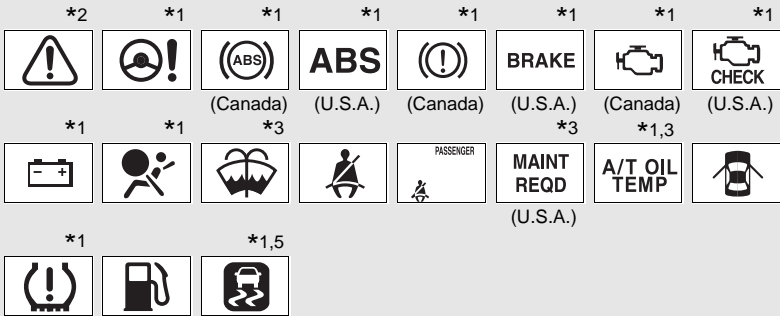

*1: These lights turn on when the engine switch is turned to the ON position to indicate that a system check is being performed. They will turn off after the engine is started, or after a few seconds. There may be a malfunction in a system if a light does not come on, or if the lights do not turn off. Have the vehicle inspected by your Toyota dealer for details.

*2: Vehicles with multi-information display

*3: Vehicles without multi-information display

*4: The indicator flashes to indicate that the system is operating.

*5: The indicator comes on to indicate a malfunction.

*6: In order to confirm operation, the BSM outside rear view mirror indicators illuminate in the following situations:

- When the engine switch is turned to the ON position while the BSM main switch is set to ON.
- When the BSM main switch is set to ON while the engine switch is in the ON position.

If the system is functioning correctly, the BSM outside rear view mirror indicators will turn off after a few seconds.

If the BSM outside rear view mirror indicators do not illuminate or do not turn off, there may be a malfunction with the system.

If this occurs, have the vehicle inspected by your Toyota dealer.

 CAUTION

■ **If a safety system warning light does not come on**

Should a safety system light such as ABS and the SRS airbag warning light not come on when you start the engine, this could mean that these systems are not available to help protect you in an accident, which could result in death or serious injury. Have the vehicle inspected by your Toyota dealer immediately if this occurs.

Multi-information display*

The multi-information display presents the driver with a variety of driving-related data.

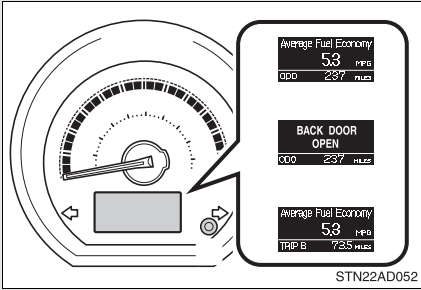

- Trip information (→P. 178)

Displays driving range, fuel consumption and other cruising-related information.

- Warning messages (→P. 480)

Automatically displayed when a malfunction occurs in one of the vehicle's systems.

- Odometer and trip meter display (→P. 171)

Trip information

Display items can be switched by pushing the INFO button.

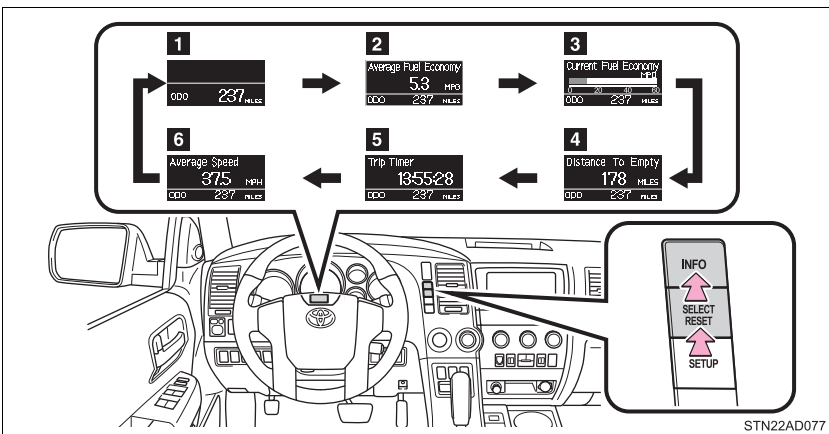

*: If equipped

1 Zoom display of odometer and trip meters

Displays the odometer and one of the trip meters simultaneously.

2 Average Fuel Economy

Displays the average fuel consumption since the function was reset.

- The function can be reset by pushing the SELECT RESET button for more than 2 seconds when the Average Fuel Economy is displayed.
- Use the displayed average fuel consumption as a reference.

3 Current Fuel Economy

Displays the current rate of fuel consumption.

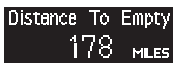
4 Distance To Empty (driving range)

Displays the estimated maximum distance that can be driven with the quantity of fuel remaining.

- This distance is computed based on your average fuel consumption. As a result, the actual distance that can be driven may differ from that displayed.
- When only a small amount of fuel is added to the tank, the display may not be updated.

5 Trip Timer



Displays the driving time.

To calculate the driving time, press the SELECT RESET button, and to stop the calculation, press it again.

To reset the calculation, press the SELECT RESET button for more than 2 seconds.

6 Average Speed



Displays the average vehicle speed since the engine was started or the function was reset.

The function can be reset by pushing the SELECT RESET button for more than 2 seconds when the Average Speed is displayed.

Feature customization

The vehicle can be customized while the vehicle is stopped.

STEP 1 Press the SETUP button to select the item you want to customize unit.

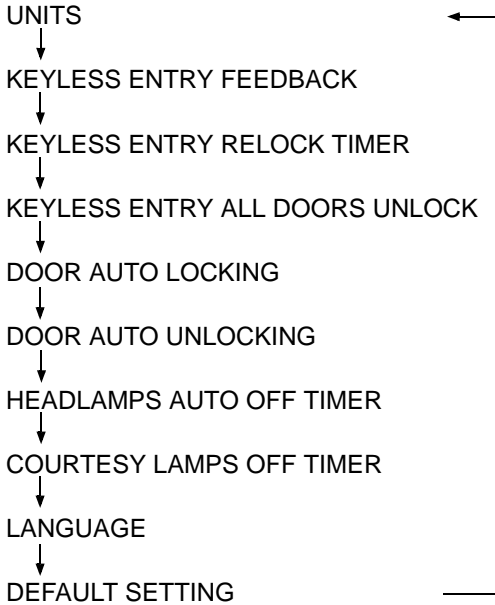

STEP 2 Press the SELECT RESET button to customize the items.

Items	Screen text	Select in this order
To select Unit A or Unit B (→P. 186)	UNITS	Unit A ↔ Unit B
Door lock/ unlock warning function	KEYLESS ENTRY FEEDBACK	LAMPS + TONE* → LAMPS ↑ ↓ OFF ← TONE
Time for auto- matic door lock function	KEYLESS ENTRY RELOCK TIMER	60 SECONDS* → 120 SECONDS ↑ ↓ 30 SECONDS ← OFF

Items	Screen text	Select in this order
Double switch operation to unlock all the doors	KEYLESS ENTRY ALL DOORS UNLOCK	2 PRESSES* \longleftrightarrow 1 PRESS
Automatic door locking function	DOOR AUTO LOCKING	SHIFT OUT \longrightarrow ABOVE 12 MPH* OF PARK (20 km/h) \uparrow OFF \longleftarrow
Automatic door unlocking function	DOOR AUTO UNLOCKING	SHIFT TO PARK* \longrightarrow DRIVER DOOR OPEN \uparrow OFF \longleftarrow
Time period before lights turn off (if a door is opened and closed, and engine switch is in ACC or LOCK)	HEADLAMPS AUTO OFF TIMER	30 SECONDS* \longrightarrow 60 SECONDS \uparrow \downarrow 0 SECONDS \longleftarrow 90 SECONDS
Time period before lights turn off	COURTESY LAMPS OFF TIMER	15 SECONDS* \longrightarrow 30 SECONDS \uparrow 8 SECONDS \longleftarrow
Selecting the language	LANGUAGE	ENGLISH* \longrightarrow FRENCH \uparrow SPANISH \longleftarrow
Reset to default setting	HOLD RESET TO RESTORE DEFAULT SETTINGS	—

*: Default setting

STEP 3 After customize is complete, press the SETUP button to set the selected item.

If the customization fails, the previously setting will be displayed.

If no button is pressed for 10 seconds, the display change to normal display.

■ **To select the unit A (English/U.S. customary system) or unit B (metric unit)**

STEP 1 Press the SETUP button to display UNITS on the multi-information display.

STEP 2 Press the SELECT RESET button to change the units.

STEP 3 Press the INFO or SETUP button and complete the unit change.

Information	Unit A	Unit B
Average Fuel Economy and Current Fuel Economy	MPG	L/100 Km
Driving Range	MILES	Km
Average Speed	MPH	Km/h
Outside temperature display on the accessory meter	°F	°C

■ **Feature customization error**

- If SYSTEM ERROR message is indicated, turn the engine switch off and then on again.
- If SYSTEM ERROR message is indicated again, contact your Toyota dealer.

 **CAUTION**

■ **Caution while driving**

Do not adjust the display.

Doing so may cause the driver to mishandle the vehicle and an accident, resulting in death or serious injury.

 **NOTICE**

■ **The multi-information display at low temperatures**

Allow the interior of the vehicle to warm up before using the liquid crystal information display. At extremely low temperatures, the information display monitor may respond slowly, and display changes may be delayed.

2-2. Instrument cluster

Accessory meter

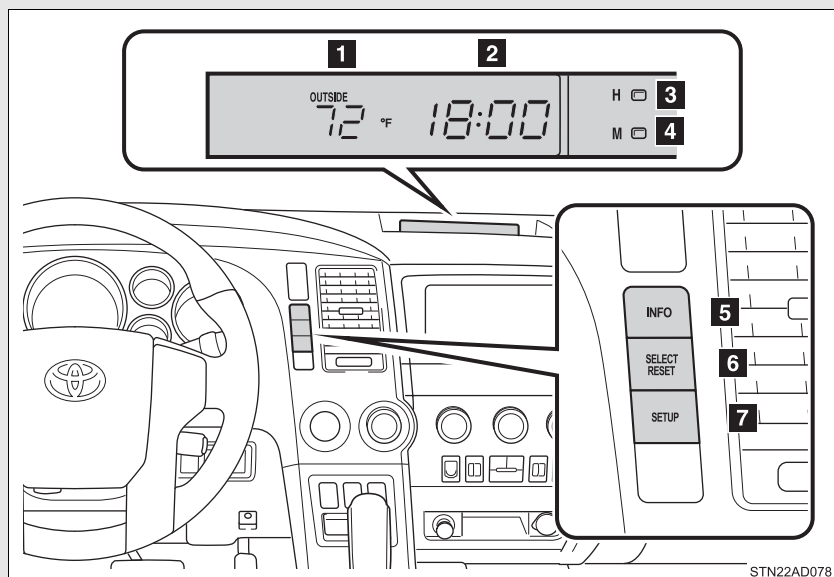

1 Outside temperature display

Displays the outside air temperature. (→P. 343)

Outside temperature and trip information display (if equipped)

Displays the outside temperature and trip information.
(→P. 171, 343)

2 Clock

(→P. 342)

3 H (Hour) button (→P. 342)

4 M (Minute) button (→P. 342)

5 INFO button (if equipped)

6 SELECT RESET button (if equipped)

7 SETUP button (if equipped)

Outside temperature and trip information display (if equipped)

Every time the INFO button is pushed, the display toggles through these information.

● OUTSIDE (outside temperature display)



Displays the outside air temperature.

● AVG (average fuel consumption after refueling)



Displays the average fuel consumption since the vehicle was last refueled.

- The function can be reset by pushing the SELECT RESET button for more than 2 seconds.
- Use the displayed average fuel consumption as a reference.

● INST (current fuel consumption)



Displays the current rate of fuel consumption.

● RANGE (driving range)



Displays the estimated maximum distance that can be driven with the quantity of fuel remaining.

- This distance is computed based on your average fuel consumption. As a result, the actual distance that can be driven may differ from that displayed.
- When only a small amount of fuel is added to the tank, the display may not be updated.

● Display off



■ **The accessory meter can be operated when**

The engine switch must be in the ON position.

■ **To select the unit A (English/U.S. customary system) or unit B (metric unit) (vehicles without multi-information display)**

Press the SETUP button to change the units.

Information	Unit A	Unit B
Average fuel consumption and current fuel consumption	MPG	L/100 Km
Driving range	MILES	Km
Outside temperature	°F	°C

 **CAUTION**

■ **Caution while driving**

Do not adjust the display.

Doing so may cause the driver to mishandle the vehicle and cause an accident, resulting in death or serious injury.



2-3. Operating the lights and wipers

Headlight switch

The headlights can be operated manually or automatically.

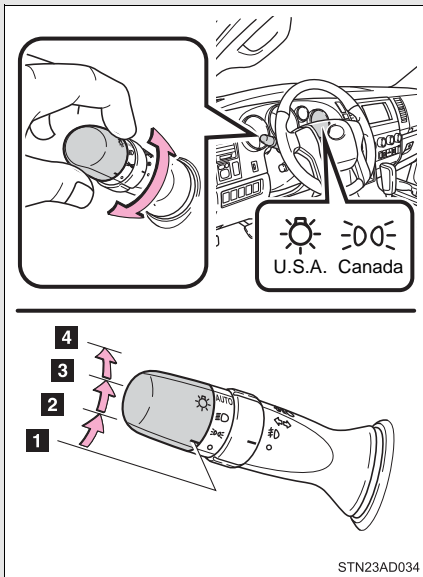

► Type A

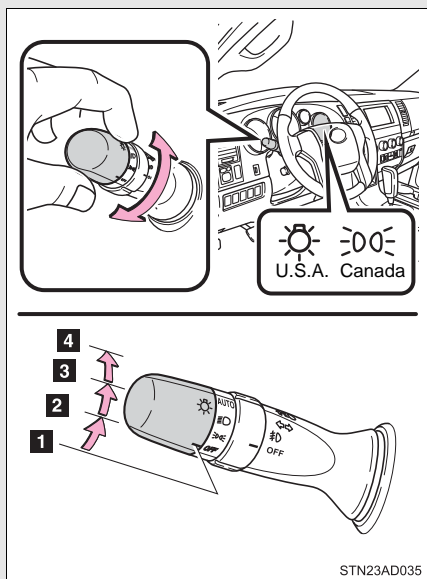

- 1**  OFF
Vehicles with daytime running light system: The daytime running lights turn on. (→P. 191)
- 2**  The side marker, parking, tail, license plate, daytime running lights (if equipped) (→P. 191) and instrument panel lights turn on.
- 3**  The headlights and all lights listed above (except daytime running lights) turn on.
- 4** **AUTO** The headlights, daytime running lights (if equipped) (→P. 191) and all lights listed above turn on and off automatically. (When the engine switch is in the ON position)

► Type B



- 1 OFF** OFF
 Vehicles with daytime running light system: The daytime running lights turn on. (→P. 191)
- 2**  The side marker, parking, tail, license plate, daytime running lights (if equipped) (→P. 191) and instrument panel lights turn on.
- 3**  The headlights and all lights listed above (except daytime running lights) turn on.
- 4 AUTO** The headlights, daytime running lights (if equipped) (→P. 191) and all lights listed above turn on and off automatically. (When the engine switch is in the ON position)

► Type C

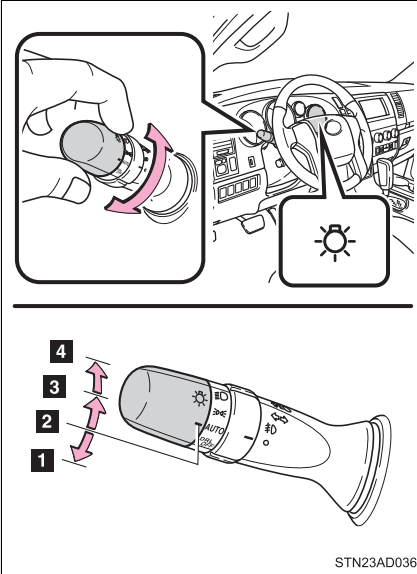

- 1 **DRL OFF** The daytime running lights turn off.
- 2 **AUTO** The headlights, side marker, parking, tail, license plate, daytime running lights (→P. 191) and instruments panel lights turn on and off automatically. (When the engine switch is in the ON position)
- 3 **≡D<** The side marker, parking, tail, license plate, daytime running lights (→P. 191) and instrument panel lights turn on.
- 4 **≡D** The headlights and all lights listed above (except daytime running lights) turn on.

► Type D

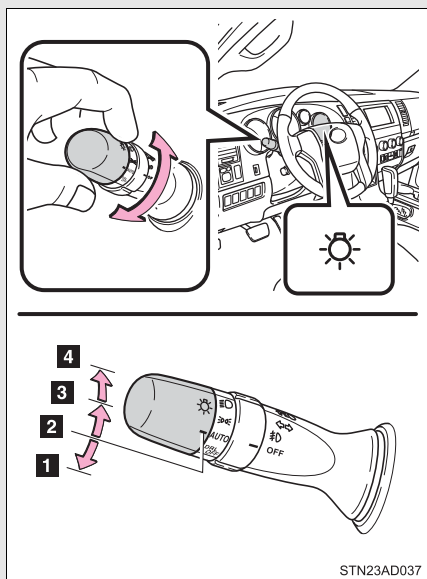

- 1 **DRL OFF** The daytime running lights turn off.
- 2 **AUTO** The headlights, side marker, parking, tail, license plate, daytime running lights (→P. 191) and instruments panel lights turn on and off automatically. (When the engine switch is in the ON position)
- 3 **≡D** The side marker, parking, tail, license plate, daytime running lights (→P. 191) and instrument panel lights turn on.
- 4 **≡D** The headlights and all lights listed above (except daytime running lights) turn on.

Turning on the high beam headlights

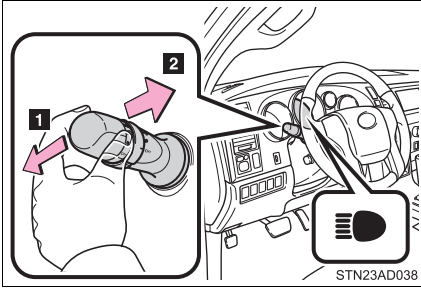

1 With the headlights on, push the lever forward to turn on the high beams.

Pull the lever back to the center position to turn the high beams off.

2 Pull the lever toward you to turn on the high beams.

Release the lever to turn them off. You can flash the high beams with the headlights on or off.

2

When driving

Daytime running light system (if equipped)

- To make your vehicle more visible to other drivers during daytime driving, the daytime running lights turn on automatically whenever the engine is started and the parking brake is released with the headlight switch off or in the "AUTO" position. (Illuminate brighter than the parking light.) Daytime running lights are not designed for use at night.

Type C and D: Daytime running lights can be turned off by operating the switch.

- Compared to turning on the headlights, the daytime running light system offers greater durability and consumes less electricity, so it can help improve fuel economy.

Headlight control sensor

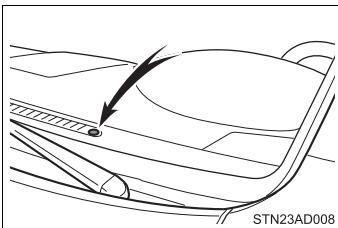



The sensor may not function properly if an object is placed on the sensor, or anything that blocks the sensor is affixed to the windshield.

Doing so interferes with the sensor detecting the level of ambient light and may cause the automatic headlight system to malfunction.

■ Automatic light off system

- When the headlights come on: The headlights and tail lights automatically turn off after 30 seconds when all doors are closed with the engine switch turned to the ACC or LOCK position. (The lights turn off immediately if the  button on the wireless remote control is pressed after all doors are locked.)
- When only the tail lights come on: The tail lights turn off automatically with the engine switch turned to the ACC or LOCK position and the driver's door is opened.

To turn the lights on again, turn the engine switch to the ON position, or turn the headlight switch off once and then back to the  or  position.

■ Customization

- That can be configured at Toyota dealer. (vehicles without multi-information display)

Settings (automatic light off system) can be changed. (Customizable features →P. 539)

- It is possible to change the settings. (vehicles with multi-information display) (Feature customization →P. 181)



NOTICE

■ To prevent battery discharge

Do not leave the lights on longer than necessary when the engine is not running.

Fog light switch*

The fog lights improve visibility in difficult driving conditions, such as in rain or fog. They can be turned on only when the headlights are on low beam.

► Type A

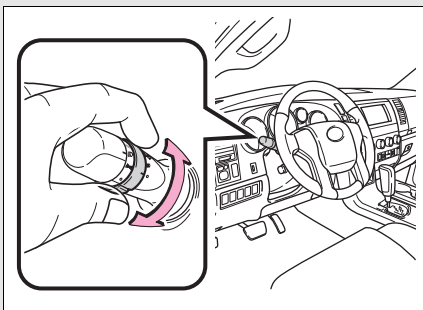

- 1 ○ OFF
- 2 ☉ Front fog lights ON

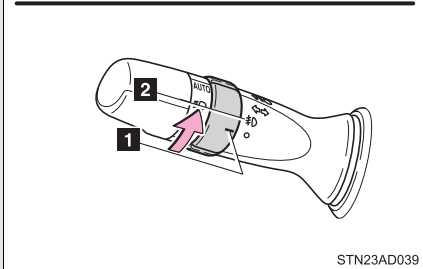

*: If equipped

► Type B

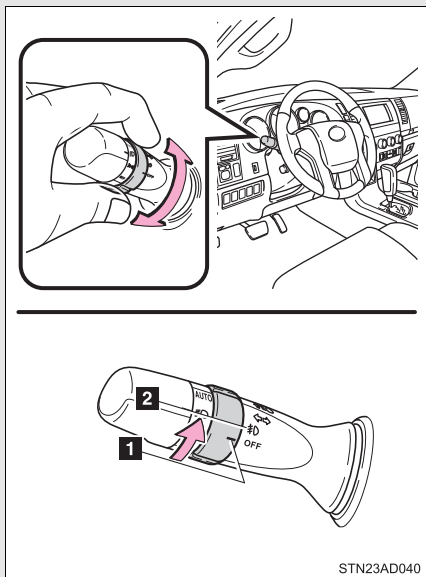

1 OFF OFF

2  Front fog lights ON





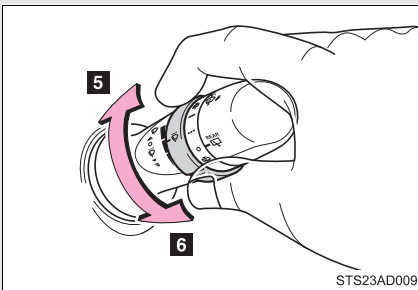
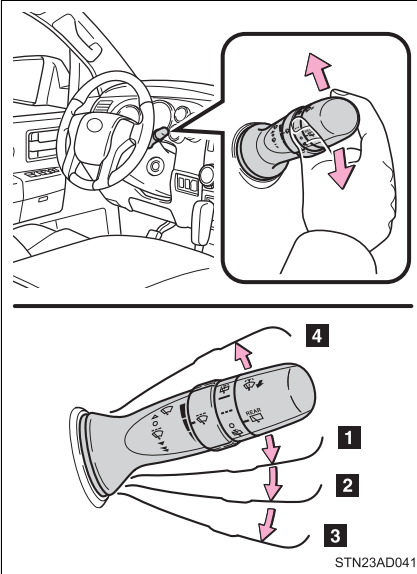

STN23AD040

2-3. Operating the lights and wipers Windshield wipers and washer

Wiper intervals can be adjusted for intermittent operation (when  or INT is selected.)

► Type A



-  Intermittent windshield wiper operation
-  Low speed windshield wiper operation
-  High speed windshield wiper operation
-  Temporary operation
-  Increases the intermittent windshield wiper frequency
-  Decreases the intermittent windshield wiper frequency

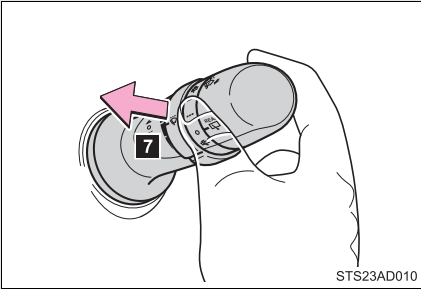

STS23AD010

► Type B

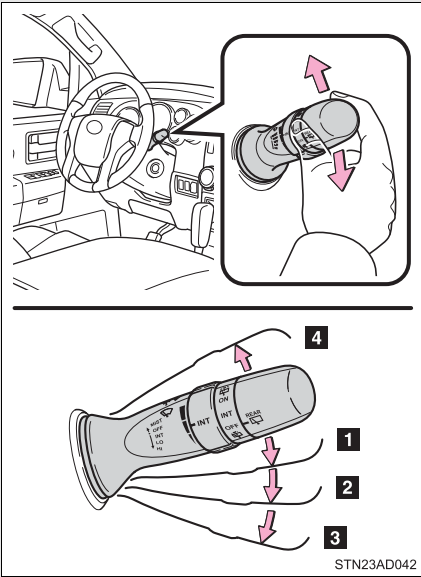

STN23AD042

7 Washer/wiper dual operation

Wipers will automatically operate a couple of times after the washer squirts.

1 INT Intermittent windshield wiper operation

2 LO Low speed windshield wiper operation

3 HI High speed windshield wiper operation

4 MIST Temporary operation

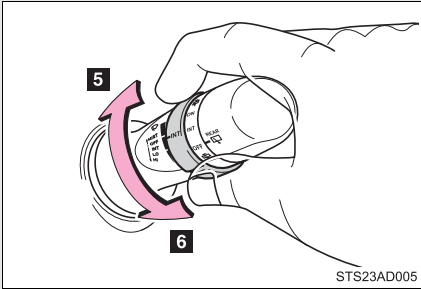

5 Increases the intermittent windshield wiper frequency

6 Decreases the intermittent windshield wiper frequency

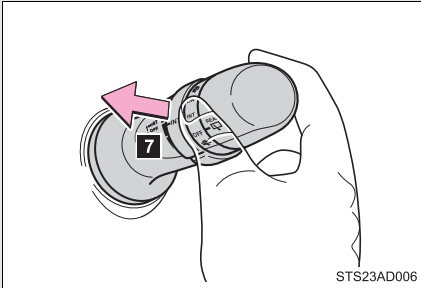

7 Washer/wiper dual operation

Wipers will automatically operate a couple of times after the washer squirts.

■ **The windshield wiper and washer can be operated when**

The engine switch must be in the ON position.

■ **If no windshield washer fluid sprays**

Check that the washer nozzles are not blocked and if there is washer fluid in the windshield washer fluid reservoir.



NOTICE

■ **When the windshield is dry**

Do not use the wipers, as they may damage the windshield.

■ **When there is no washer fluid spray from the nozzle**

Damage to the washer fluid pump may be caused if the lever is pulled toward you and held continually.

■ **When a nozzle becomes blocked**

In this case, contact your Toyota dealer.



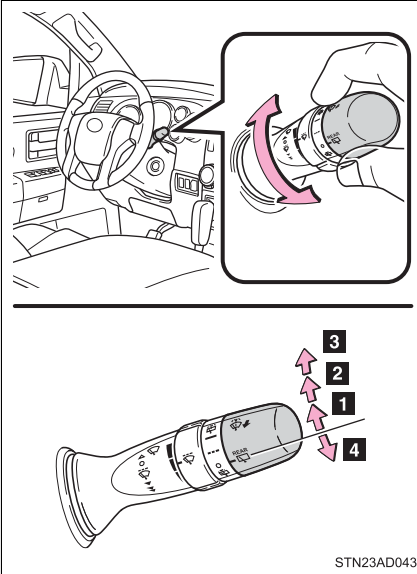

Do not try to clear it with a pin or other object. The nozzle will be damaged.

Rear window wiper and washer

► Type A





STN23AD043

- 1  Intermittent window wiper operation
- 2  Normal window wiper operation
- 3  Washer/wiper dual operation
- 4  Washer/wiper dual operation

The rear window wiper operates while the washer squirts.

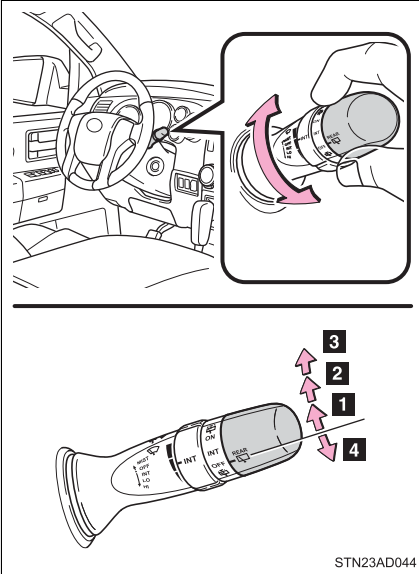
► Type B



- 1 **INT** Intermittent window wiper operation
- 2 **ON** Normal window wiper operation
- 3  Washer/wiper dual operation
- 4  Washer/wiper dual operation

The rear window wiper operates while the washer squirts.

STN23AD044

■ **The rear window wiper and washer can be operated when**

- The engine switch must be in the ON position.
- The back window is fully closed.

■ **Customization that can be configured at Toyota dealer**

Settings (e.g. washer linkage wiper control) can be changed.
(Customizable features→P. 539)

 **NOTICE**

■ **When the rear window is dry**

Do not use the wipers, as they may damage the rear window.

2-3. Operating the lights and wipers Headlight cleaner switch*

Washer fluid can be sprayed on the headlights.

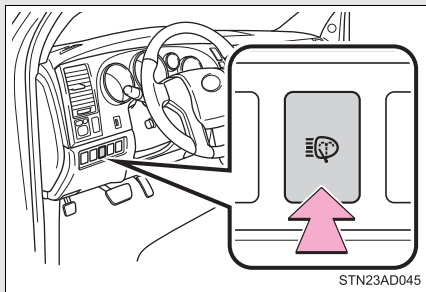

Press the switch to clean the headlights.

2

When driving

■ The headlight cleaner can be operated when

The engine switch is in the ON position and the headlights are turned on.



NOTICE

■ When the washer fluid tank is empty

Do not use this function when the washer fluid tank is empty. This may cause the washer fluid pump to overheat.

*: If equipped

2-4. Using other driving systems

Cruise control

Use the cruise control to maintain a set speed without depressing the accelerator pedal.

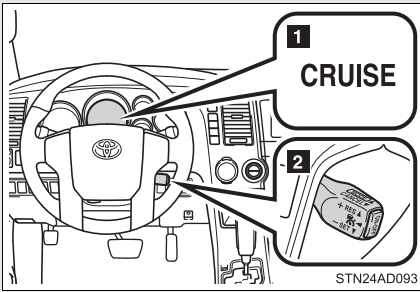

- 1 Indicator
- 2 Cruise control switch

■ Setting the vehicle speed

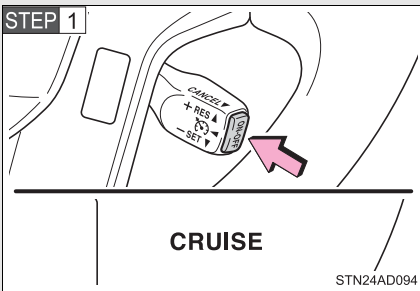

Press the ON-OFF button to activate the cruise control.

Cruise control indicator will come on.

Press the button again to deactivate the cruise control.

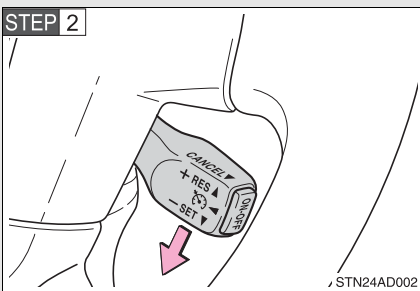

Accelerate or decelerate the vehicle to the desired speed, and push the lever down to set the speed.

The vehicle speed at the moment the lever is released becomes the set speed.

■ Adjusting the set speed

To change the set speed, operate the lever until the desired set speed is obtained.

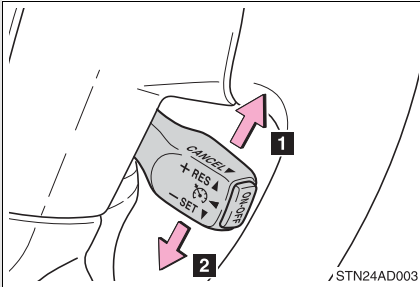

- 1** Increases the speed
- 2** Decreases the speed

Fine adjustment: Momentarily move the lever in the desired direction.

Large adjustment: Hold the lever in the desired direction.

The set speed will be increased or decreased as follows:

Fine adjustment: By approximately 1 mph (1.6 km/h) each time the lever is operated.

Large adjustment: The set speed can be increased or decreased continually until the lever is released.

■ Canceling and resuming the constant speed control

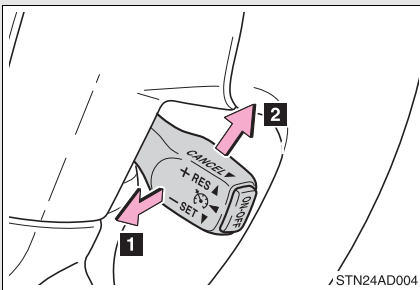

- 1** Pulling the lever toward you cancels the constant speed control.

The speed setting is also canceled when the brakes are applied.

- 2** Pushing the lever up resumes the constant speed control.

Resuming is available when the vehicle speed is more than approximately 25 mph (40 km/h).

■ **Cruise control can be set when**

- The shift lever is in the D or range 4 or higher of S has been selected.
- Vehicle speed is above approximately 25 mph (40 km/h).

■ **Accelerating after setting the vehicle speed**

- The vehicle can be accelerated normally. After acceleration, the set speed resumes.
- Even without canceling the cruise control, the set speed can be increased by first accelerating the vehicle to the desired speed and then pushing the lever down to set the new speed.

■ **Automatic cruise control cancelation**

Cruise control will stop maintaining the vehicle speed in any of the following situations.

- Actual vehicle speed falls more than approximately 10 mph (16 km/h) below the preset vehicle speed.
At this time, the memorized set speed is not retained.
- Actual vehicle speed is below approximately 25 mph (40 km/h).
- VSC is activated.
- The operation cannot be switched for 5 seconds or more after operating the front wheel drive control switch or the center differential lock switch. (4WD models)

■ **If the cruise control indicator flashes**

Press the ON-OFF button once to deactivate the system, and then press the button again to reactivate the system.

If the cruise control speed cannot be set or if the cruise control cancels immediately after being activated, there may be a malfunction in the cruise control system. Have the vehicle inspected by your Toyota dealer.

 **CAUTION****■ To avoid operating the cruise control by mistake**

Switch the cruise control off using the ON-OFF button when not in use.

■ Situations unsuitable for cruise control

Do not use cruise control in any of the following situations.

Doing so may result in loss of control and could cause an accident resulting in death or serious injury.

- In heavy traffic
- On roads with sharp bends
- On winding roads
- On slippery roads, such as those covered with rain, ice or snow
- On steep hills
Vehicle speed may exceed the set speed when driving down a steep hill.
- When your vehicle is towing a trailer or during emergency towing

2-4. Using other driving systems

Dynamic laser cruise control*

Dynamic laser cruise control supplements conventional cruise control with a vehicle-to-vehicle distance control. In vehicle-to-vehicle distance control mode, the vehicle automatically accelerates or decelerates in order to maintain a set following distance from vehicles ahead.

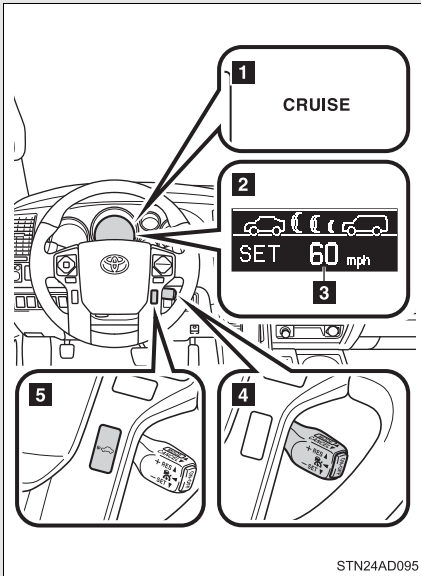

- 1 Indicator
- 2 Display
- 3 Set speed
- 4 Cruise control switch
- 5 Vehicle-to-vehicle distance button

STN24AD095

*: If equipped

■ Setting the vehicle speed (vehicle-to-vehicle distance control mode)

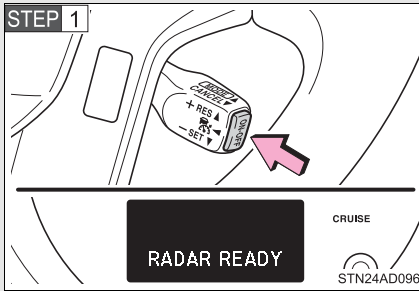

Press the ON-OFF button to activate the cruise control.

Cruise control indicator will come on.

Press the button again to deactivate the cruise control.

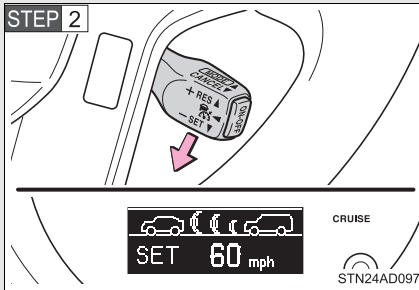

Accelerate or decelerate the vehicle to the desired speed, and push the lever down to set the speed.

SET will be displayed.

The vehicle speed at the moment the lever is released becomes the set speed.

■ Adjusting the set speed

To change the set speed, operate the lever until the desired set speed is displayed.

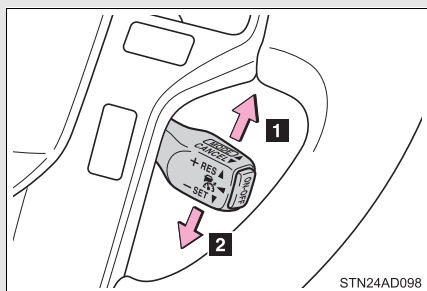

1 Increases the speed

2 Decreases the speed

Fine adjustment: Momentarily move the lever in the desired direction.

Large adjustment: Hold the lever in the desired direction.

In the vehicle-to-vehicle distance control mode, the set speed will be increased or decreased as follows:

- When the set speed is shown in “MPH”
Fine adjustment: By approximately 5 mph (8 km/h) each time the lever is operated
Large adjustment: By approximately 5 mph (8 km/h) for each 0.75 seconds the lever is held
- When the set speed is shown in “km/h”
Fine adjustment: By approximately 3.1 mph (5 km/h) each time the lever is operated
Large adjustment: By approximately 3.1 mph (5 km/h) for each 0.75 seconds the lever is held

In the constant speed control mode (→P. 213), the set speed will be increased or decreased as follows:

Fine adjustment: By approximately 1 mph (1.6 km/h) each time the lever is operated.

Large adjustment: The set speed can be increased or decreased continually until the lever is released.

■ Changing the vehicle-to-vehicle distance

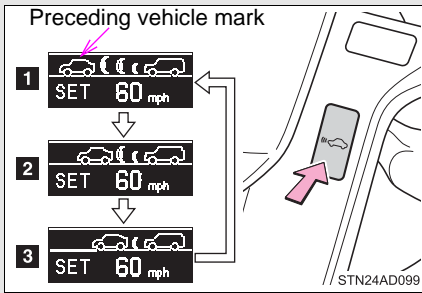

Pressing the button changes the vehicle-to-vehicle distance as follows:

- 1 Long
- 2 Medium
- 3 Short

The vehicle-to-vehicle distance is set automatically to long mode when the engine switch is turned to the ON position.

If a vehicle is running ahead of you, the preceding vehicle mark will also be displayed.

■ Vehicle-to-vehicle distance settings

Select a distance from the table below. Note that the distances shown correspond to a vehicle speed of 55 mph (90 km/h). Vehicle-to-vehicle distance increases/decreases in accordance with vehicle speed.

Distance options	Vehicle-to-vehicle distance
Long	Approximately 245 ft. (75 m)
Medium	Approximately 165 ft. (50 m)
Short	Approximately 100 ft. (30 m)

■ Canceling and resuming the speed control

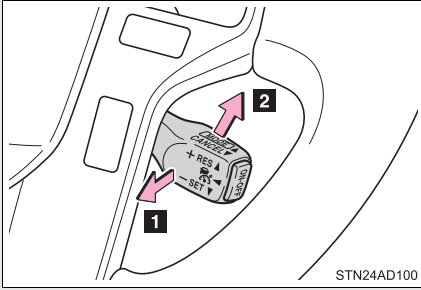

- 1** Pulling the lever toward you cancels the cruise control.

The speed setting is also canceled when the brakes are applied.

- 2** Pushing the lever up resumes the cruise control and returns vehicle speed to the set speed.

Resuming is available when the vehicle speed is more than approximately 25 mph (40 km/h).

Driving in vehicle-to-vehicle distance control mode

This mode employs a laser radar sensor to detect the presence of vehicles up to approximately 400 ft. (120 m) ahead, determines the current vehicle-to-vehicle following distance, and operates to maintain a suitable following distance from the vehicle ahead.

Note that vehicle-to-vehicle distance will close in when traveling on long downhill slopes.

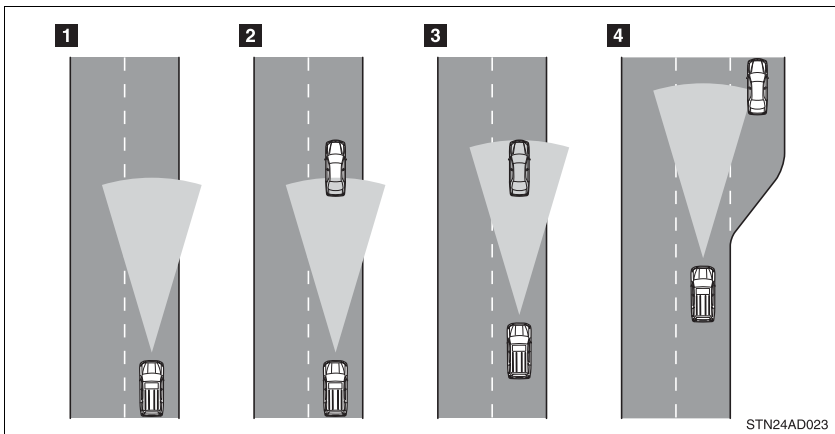

1 Example of constant speed cruising

When there are no vehicles ahead

The vehicle travels at the speed set by the driver. The desired vehicle-to-vehicle distance can also be set by operating the vehicle-to-vehicle distance control.

2 Example of deceleration cruising

When the vehicle ahead is driving slower than the set speed

When a vehicle is detected running ahead of you, the system automatically decelerates your vehicle. When a greater reduction in vehicle speed is necessary, the system applies the brakes. A warning tone warns you when the system cannot decelerate sufficiently to prevent your vehicle from closing in on the vehicle ahead.

3 Example of follow-up cruising

When following a vehicle driving slower than the set speed

The system continues follow-up cruising while adjusting for changes in the speed of the vehicle ahead in order to maintain the vehicle-to-vehicle distance set by the driver.

4 Example of acceleration

When there are no longer any vehicles ahead driving slower than the set speed

The system accelerates until the set speed is reached. The system then returns to constant speed cruising.

Approach warning

When your vehicle is too close to a vehicle ahead, and sufficient automatic deceleration via the cruise control is not possible, the display will flash and the buzzer will sound to alert the driver. An example of this would be if another driver cuts in front of you while you are following a vehicle. Apply the brakes to ensure an appropriate vehicle-to-vehicle distance.

■ Warnings may not occur when

In the following instances, there is a possibility that the warnings will not occur:

- When the speed of the vehicle ahead matches or exceeds your vehicle speed
- When the vehicle ahead is traveling at an extremely slow speed
- Immediately after the cruise control speed was set
- At the instant the accelerator is applied

Selecting conventional constant speed control mode

Constant speed control mode differs from vehicle-to-vehicle distance control mode. When constant speed control mode is selected, your vehicle will maintain a set speed regardless of whether or not there are other vehicles in the lane ahead.

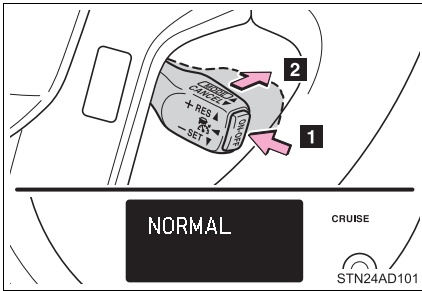

- 1 Press the ON-OFF button to activate the cruise control.

Press the button again to deactivate the cruise control.

- 2 Switch to constant speed control mode.

(Push the lever forward and hold for approximately one second.)

Constant speed control mode indicator will come on.

When in constant speed control mode, to return to vehicle-to-vehicle distance control mode, push the lever forward again and hold for approximately 1 second.

After the desired speed has been set, it is not possible to return to vehicle-to-vehicle distance control mode.

If the engine switch is turned off and then turned to the ON position again, the vehicle will automatically return to vehicle-to-vehicle distance control mode.

Adjusting the speed setting:

→P. 208

Canceling and resuming the speed setting: →P. 210

■ **Dynamic laser cruise control can be set when**

- The shift lever is in the D or range 4 or higher of S has been selected.
- Vehicle speed is above approximately 30 mph (50 km/h).

■ **Switching modes**

The mode cannot be switched to constant speed control mode if vehicle-to-vehicle distance control mode has been used. The mode also cannot be switched from constant speed control to vehicle-to-vehicle distance control mode. Turn the system off by pressing the ON-OFF button, and turn it on again.

■ **Accelerating after setting the vehicle speed**

The vehicle can accelerate normally. After acceleration, the set speed resumes. However, during vehicle-to-vehicle distance control mode, the vehicle speed may decrease below the set speed in order to maintain the distance to the vehicle ahead.

■ **Automatic cancelation of vehicle-to-vehicle distance control**

Vehicle-to-vehicle distance control driving is automatically canceled in the following situations:

- Actual vehicle speed falls below approximately 25 mph (40 km/h)
- VSC is activated
- The sensor cannot operate correctly because it is covered in some way.*
- The windshield wipers are operating at high or low speed.*
- The operation cannot be switched for 5 seconds or more after operating the front wheel drive control switch or the center differential lock switch. (4WD models)

*: Vehicle-to-vehicle distance control driving must be reset by pressing the ON-OFF button again.

If vehicle-to-vehicle distance control driving is automatically canceled for any other reason, there may be a malfunction in the system. Contact your Toyota dealer.

■ Automatic cancelation of constant speed control

The cruise control will stop maintaining the vehicle speed in the following situations:

- Actual vehicle speed is more than approximately 10 mph (16 km/h) below the set vehicle speed
At this time, the memorized set speed is not retained.
- Vehicle speed falls below approximately 25 mph (40 km/h)
- VSC is activated
- The operation cannot be switched for 5 seconds or more after operating the front wheel drive control switch or the center differential lock switch. (4WD models)

■ Laser radar sensor

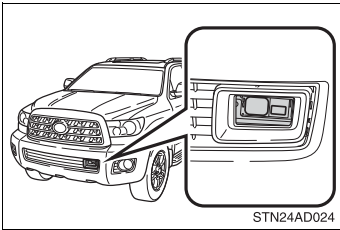

Always keep the sensor clean to ensure that the vehicle-to-vehicle distance control operates properly. (Some obstructions, such as snow, ice and plastic objects, cannot be detected by the obstruction sensor.)

Dynamic laser cruise control is canceled if an obstruction is detected.

■ Warning lights, messages and buzzers for dynamic laser cruise control

Warning lights, messages and buzzers are used to indicate a system malfunction or to inform the driver of the need for caution while driving.

(→P. 480)

■ Certification

This product is a class I laser product complied with 21C.F.R part 1040.10 and 1040.11.

 **CAUTION**

■ Before using dynamic laser cruise control

Do not overly rely on vehicle-to-vehicle distance control.

Be aware of the set speed. If automatic deceleration/acceleration is not appropriate, adjust the vehicle speed, as well as the distance between your vehicle and vehicles ahead by applying the brakes etc.

■ Cautions regarding the driving assist systems

Observe the following precautions.

Failure to do so may cause an accident resulting in death or serious injury.

● Assisting the driver to measure following distance

The dynamic laser cruise control is only intended to help the driver in determining the following distance between the driver's own vehicle and a designated vehicle traveling ahead. It is not a mechanism that allows careless or inattentive driving, and it is not a system that can assist the driver in low-visibility conditions. It is still necessary for driver to pay close attention to the vehicle's surroundings.

● Assisting the driver to judge proper following distance

The dynamic laser cruise control determines whether the following distance between the driver's own vehicle and a designated vehicle traveling ahead is appropriate or not. It is not capable of making any other type of judgement. Therefore, it is absolutely necessary for the driver to remain vigilant and to determine whether or not there is a possibility of danger in any given situation.

● Assisting the driver to operate the vehicle

The dynamic laser cruise control has no capability to prevent or avoid a collision with a vehicle traveling ahead. Therefore, if there is ever any danger, the driver must take immediate and direct control of the vehicle and act appropriately in order to ensure the safety of all involved.

■ To avoid inadvertent cruise control activation

Switch the cruise control off using the ON-OFF button when not in use.

 CAUTION**■ Situations unsuitable for dynamic laser cruise control**

Do not use dynamic laser cruise control in any of the following situations. Doing so may result in inappropriate speed control and could cause an accident resulting in death or serious injury.

- In heavy traffic
- On roads with sharp bends
- On winding roads
- On slippery roads, such as those covered with rain, ice or snow
- On steep downhills, or where there are sudden changes between sharp up and down gradients
Vehicle speed may exceed the set speed when driving down a steep hill.
- At entrances to expressways
- When weather conditions are bad enough that they may prevent the sensors from functioning correctly (fog, rain, snow, sandstorm, direct sunlight, etc.)
- When an approach warning buzzer is heard often
- When your vehicle is towing a trailer or during emergency towing

 CAUTION

■ **When the sensor may not be correctly detecting the vehicle ahead**

Apply the brakes as necessary when any of the following types of vehicles are in front of you.

As the sensor may not be able to correctly detect these types of vehicles, the approach warning (→P. 480) will not be activated, and a fatal or serious accident may result.

- The vehicle ahead has higher ground clearance, which means that the placement of the reflectors is in a higher position.
- The rear section of the vehicle ahead is extremely dirty.
- The vehicle ahead or other vehicles around you are flinging up water or snow.
- Excessive exhaust gas (black smoke) is coming from the vehicle ahead or other vehicles around you, obscuring your front view.
- There is an obstruction (protective film, sticker, etc.) on the reflectors on the vehicle ahead, or reflectors are not installed on the vehicle ahead or are damaged.
- Heavy luggage in the luggage compartment or rear seats is causing the nose of your vehicle to tilt up.
- Vehicles that cut in suddenly
- Vehicles traveling at low speeds
- Vehicles that are not moving
- Vehicles with small rear ends (trailers with no load on board etc.)
- Motorcycles traveling in the same lane

 CAUTION

■ Conditions under which the vehicle-to-vehicle distance control may not function correctly

Apply the brakes as necessary in the following conditions as the laser radar sensor may not be able to correctly detect vehicles ahead, and a fatal or serious accident may result.

- When water or snow thrown up by the surrounding vehicles hinders the functioning of the sensor
- When your vehicle is pointing upwards (caused by a heavy load in the luggage compartment etc.)
- When the road curves or when the lanes are narrow
- When steering wheel operation or your position in the lane is unstable
- When the vehicle ahead of you decelerates suddenly
- When your vehicle is towing a trailer or during emergency towing

■ Handling the laser radar sensor

Observe the following to ensure the cruise control system can function effectively.

Otherwise, the system may not function correctly and could result in an accident.

- Keep the sensor clean at all times.
Clean the sensor with a soft cloth so you do not mark or damage them.
- Do not subject the sensor or surrounding area to a strong impact.
If the sensor moves even slightly off position, the system may malfunction.
If the sensor or surrounding area is subject to a strong impact, always have the area inspected and adjusted by a Toyota dealer.
- Do not disassemble the sensor.
- Do not attach accessories or stickers to the sensor, surrounding area.
- Do not modify or paint the sensor.
- If the laser radar sensor needs to be replaced, contact your Toyota dealer.

2-4. Using other driving systems

Intuitive parking assist*

The intuitive parking assist is designed to inform you of the approximate distance between your vehicle and an obstruction by indicator and buzzer when parking the vehicle. This system uses sensors to detect obstructions.

This system works when the engine switch is in the ON position and the shift lever is not in P.

Back and rear corner sensors work only when the shift lever is in R.

Front corner sensors work when:

- The shift lever is in R
- The shift lever is not in P or R and vehicle speed is approximate 6 mph (10 km/h) or less.

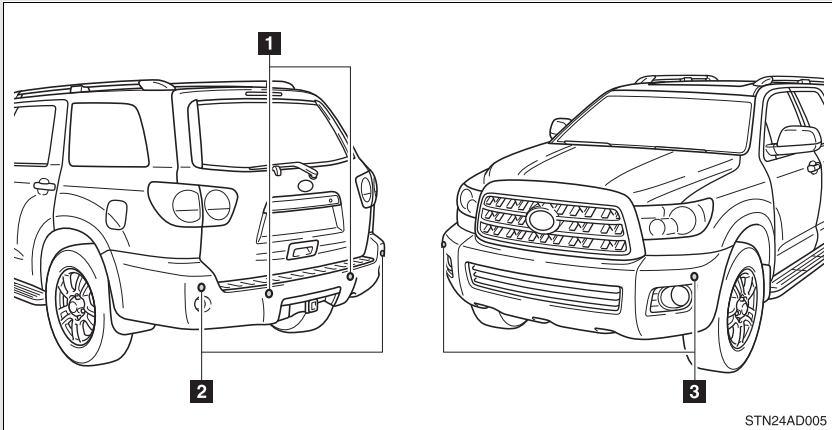

- 1** Back sensors
- 2** Rear corner sensors
- 3** Front corner sensors

*: If equipped

■ Intuitive parking assist switch

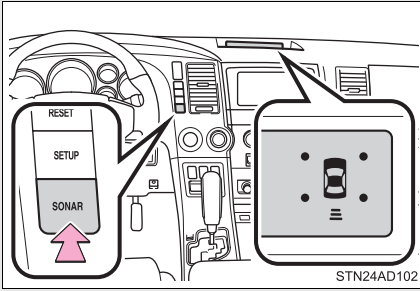

Press the switch to turn on. (To turn off, press the switch again.)

When on, the indicator light comes on to inform the driver that the system is operational.

The distance and buzzer

■ When a sensor detects an obstacle.

The buzzer sounds.

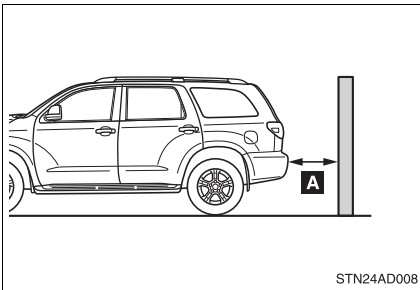

Back sensors

Zone	Distance shown as A in in. (mm)	Indicator and buzzer
Far	Approximately 70.9 — 45.3 (1800 — 1150)	Intermittent
Mid	Approximately 45.3 — 33.5 (1150 — 850)	Fast intermittent
Near	Approximately 33.5 (850) or less	Continuous

2
When driving

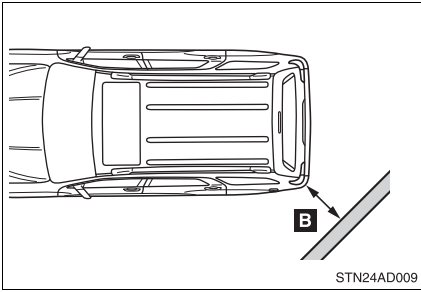

Rear corner sensors

Zone	Distance shown as B in in. (mm)	Indicator and buzzer
Far	Approximately 33.5 — 20.5 (850 — 520)	Intermittent
Mid	Approximately 20.5 — 15.7 (520 — 400)	Fast intermittent
Near	Approximately 15.7 (400) or less	Continuous

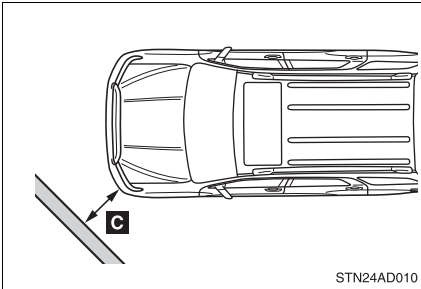

Front corner sensors

Zone	Distance shown as C in in. (mm)	Indicator and buzzer
Far	Approximately 23.6 — 15.7 (600 — 400)	Intermittent
Mid	Approximately 15.7 — 9.8 (400 — 250)	Fast intermittent
Near	Approximately 9.8 (250) or less	Continuous

■ When two or more obstacles are detected simultaneously

The buzzer system responds to the nearest zone.

■ When multiple obstacles are detected in front and behind the vehicle at the same time

The buzzer will change in the following manner.

- If an obstacle has been detected within 15.7 in. (400 mm) of the front or 33.5 in. (850 mm) in rear of the vehicle (a continuous buzzer is sounding), and a new obstacle is detected at the other end of the vehicle, the buzzer will sound 7 times then one continuous buzzer.
- If an obstacle has been detected within 15.7 in. (400 mm) of the front or 33.5 in. (850 mm) in rear of the vehicle (a continuous buzzer is sounding), and a new obstacle is detected at the same way at the other end of the vehicle, the buzzer will sound 3 times then one continuous buzzer.

Sensors that operate and detection range

The following diagrams show the sensor detection range. Note that sensors may not be able to detect obstacles that are extremely close to the vehicle.

■ Detection range of the sensors

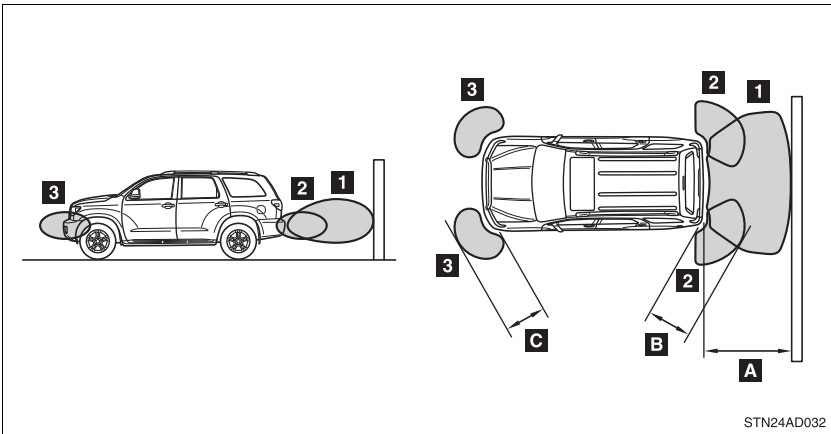

1 Back sensors

2 Rear corner sensors

3 Front corner sensors

Perceptible area

A Approx. 70.9 in. (1800 mm)

B Approx. 33.5 in. (850 mm)

C Approx. 23.6 in. (600 mm)

The diagram shows the detection range of the sensors. Note that the sensors may not be able to detect obstacles that are extremely close to the vehicle.

The range of the sensors may change depending on the shape of the object etc.

■ Sensor detection information

● Certain vehicle conditions and the surrounding environment may affect the ability of a sensor to correctly detect an obstacle. Particular instances where this may occur are listed below.

- There is dirt, snow or ice on a sensor.
- A sensor is frozen.
- A sensor is covered in any way.
- The vehicle is leaning considerably to one side.
- On an extremely bumpy road, on an incline, on gravel, or on grass.
- The vicinity of the vehicle is noisy due to vehicle horns, motorcycle engines, air brakes of large vehicles, or other loud noises producing ultrasonic waves.
- There is another vehicle equipped with parking assist sensors in the vicinity.
- A sensor is coated with a sheet of spray or heavy rain.
- The vehicle is equipped with a fender pole or radio antenna.
- A bumper or sensor receives a strong impact.
- The vehicle is approaching a tall or right-angled curb.
- In harsh sunlight or intense cold weather.
- The area directly under the bumpers is not detected.
Objects lower than the sensors or thin stakes etc. may be detected initially, but as they draw closer, they may cease to be detected.
- A towing hitch is mounted to the vehicle.
- A non-genuine Toyota suspension (lowered suspension etc.) is installed.
- When attaching a two-way radio antenna.
- When a towing eyelet is mounted on your vehicle.
- When the bumper is damaged.

In addition to the examples above, there are instances in which, because of their shapes, signs and other objects may be judged by a sensor to be closer than they are.

● The shape of the obstacle may prevent a sensor from detecting it. Pay particular attention to the following obstacles:

- Wires, fences, ropes, etc.
- Cotton, snow and other materials that absorb sound waves
- Sharply-angled objects
- Low obstacles
- Tall obstacles with upper sections projecting outwards in the direction of your vehicle
- A person near the vehicle (depending on the type of clothes worn)
- When the bumper is damaged.

■ Certification (Canada only)

This ISM device complies with Canadian ICES-001.

■ If the indicator is continuously on

Have the vehicle inspected by your Toyota dealer.

■ If the indicator remains blinking but do not sound the buzzer

Clean the sensors with soft cloth.

CAUTION

■ Caution when using the intuitive parking assist

Observe the following precautions.

Failure to do so may result in the vehicle being unable to be driven safely and possibly cause an accident.

- Do not use the sensor at speeds in excess of 6 mph (10 km/h).
- Do not attach any accessories within the sensor range.
- When moving forward or reversing, always check your surroundings for safety and drive carefully.

NOTICE

■ Notes when washing the vehicle

Do not apply intensive bursts of water or steam to the sensor area. Doing so may result in the sensor malfunctioning.

2-4. Using other driving systems BSM (Blind Spot Monitor)*

The **Blind Spot Monitor** is a system that assists the driver to confirm safety when changing lanes.

The system uses radar sensors to detect vehicles that are traveling in an adjacent lane in the area that is not reflected in the outside rear view mirror (the blind spot), and advises the driver of the vehicle's existence via the outside rear view mirror indicator.

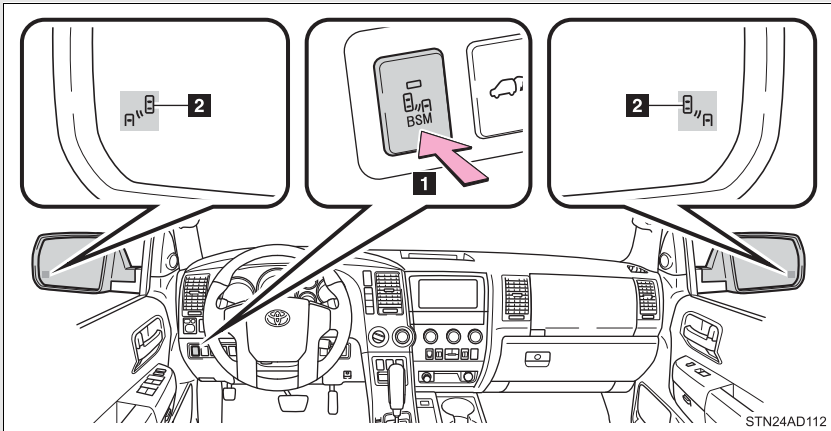

1 BSM main switch

Pressing the switch turns the system on or off. When the switch is set to on, the switch's indicator illuminates.

2 Outside rear view mirror indicator

When a vehicle is detected in the blind spot, the outside rear view mirror indicator on that side illuminates. If the turn signal lever is operated when a vehicle is in the blind spot, the outside rear view mirror indicator flashes.

The Blind Spot Monitor system detection areas

The blind spot that vehicles can be detected in are outlined below.

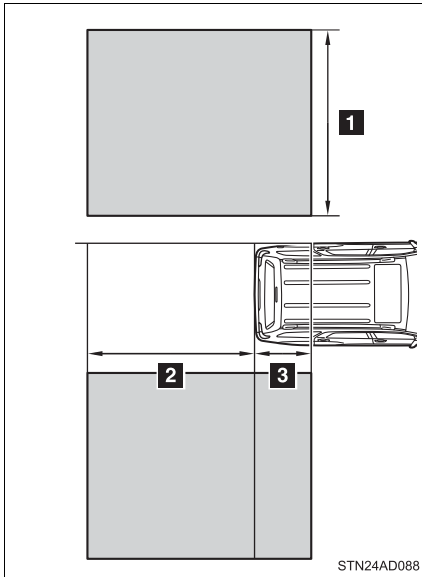

The range of the detection area extends to:

- 1 Approximately 11.5 ft. (3.5 m) from the side of the vehicle

The first 1.6 ft. (0.5 m) from the side of the vehicle is not in the detection area

- 2 Approximately 9.8 ft. (3 m) from the rear bumper
- 3 Approximately 3.3 ft. (1 m) forward of the rear bumper

■ The Blind Spot Monitor is operational when

The BSM main switch is set to ON and vehicle speed is greater than about 25 mph (40 km/h)

■ The Blind Spot Monitor will detect a vehicle when

- A vehicle in an adjacent lane overtakes the vehicle.
- Another vehicle enters the detection area when it changes lanes.

■ Conditions under which the Blind Spot Monitor will not detect a vehicle

The Blind Spot Monitor is not designed to detect the following types of vehicles and/or objects:

- Vehicles traveling in the opposite direction
- Small motorcycles, bicycles, pedestrians etc.*
- Following vehicles that are in the same lane*
- Guardrails, walls, signs, parked vehicles and similar stationary objects*
- Vehicles driving 2 lanes across from your vehicle*

*: Depending on conditions, detection of a vehicle and/or object may occur

■ Conditions under which the Blind Spot Monitor may not function correctly

- The Blind Spot Monitor may not detect vehicles correctly in the following conditions:
 - During bad weather such as heavy rain, fog, snow etc.
 - When ice or mud etc. is attached to the rear bumper
 - When driving on a road surface that is wet due to rain, previous rain, standing water etc.
 - When there is a significant difference in speed between your vehicle and the vehicle that enters the detection area
 - When a vehicle is in the detection area from a stop and remains in the detection area as your vehicle accelerates
 - When driving up or down consecutive steep inclines, such as hills, a dip in the road etc.
 - When multiple vehicles approach with only a small gap between each vehicle
 - When vehicle lanes are wide, and the vehicle in the next lane is too far away from your vehicle
 - When the vehicle that enters the detection area is traveling at about the same speed as your vehicle
 - When towing anything such as trailer, boat, etc.
 - When there is a significant difference in height between your vehicle and the vehicle that enters the detection area
 - Directly after the BSM switch is set to on
 - When items such as a bicycle carrier are installed on the rear of the vehicle

- Instances of the Blind Spot Monitor unnecessarily detecting a vehicle and/or object may increase under the following conditions:
 - When there is only a short distance between your vehicle and a guard-rail, wall etc.
 - When there is only a short distance between your vehicle and a following vehicle
 - When vehicle lanes are narrow and a vehicle driving 2 lanes across from your vehicle enters the detection area

■ The outside rear view mirror indicators visibility

When under strong sunlight, the outside rear view mirror indicator may be difficult to see.

■ When there is a malfunction in the system

If a system malfunction is detected due to any of the following reasons, warning messages will be displayed: (→P. 480)

- There is a malfunction with the sensors
- The sensors have become dirty
- The outside temperature is extremely high or low
- The sensor voltage has become abnormal

■ Certification for the BSM

► For vehicles sold in the U.S.A.

FCC ID: OAYBSDTX

This device complies with part 15 of the FCC Rules. Operation is subject to the following three conditions:

- (1) This device may not cause harmful interference.
- (2) This device must accept any interference received, including interference that may cause undesired operation.
- (3) This device may only work when the vehicle is in operation pursuant to § 15.252 (a) (4).

FCC WARNING

Changes or modifications not expressly approved by the party responsible for compliance could void the user's authority to operate the equipment.

► For vehicles sold in Canada

IC: 4135A-BSDTX

This device complies with the radio standards specification RSS-220 of Industry Canada.

Operation is subject to the following two conditions:

- (1) This device may not cause harmful interference.
- (2) This device must accept any interference received, including interference that may cause undesired operation.

NOTE

During printing time of this user manual the approvals listed below are granted.

Further countries may become available or actual certification identifiers may be subject to change or update.

WARNING

Changes or modifications not expressly approved by the party responsible for compliance could void the user's authority to operate the equipment.

⚠ CAUTION

■ Cautions regarding the use of the system

The driver is solely responsible for safe driving. Always drive safely, taking care to observe your surroundings.

The Blind Spot Monitor is a supplementary system which alerts the driver that a vehicle is present in the blind spot. Do not overly rely on the Blind Spot Monitor. The system cannot judge if it is safe to change lanes, therefore over reliance could cause an accident resulting in death or serious injury. According to conditions, the system may not function correctly. Therefore the driver's own visual confirmation of safety is necessary.

■ Handling the radar sensor

One Blind Spot Monitor installed inside the left and right side of the vehicle rear bumper respectively. Observe the following to ensure the Blind Spot Monitor can function correctly.

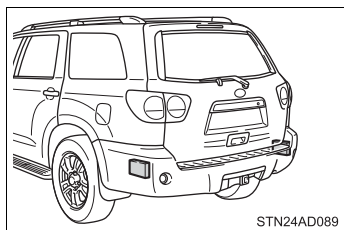

- Keep the sensor and its surrounding area on the bumper clean at all times.

- Do not subject the sensor or surrounding area on the bumper to a strong impact. If the sensor moves even slightly off position, the system may malfunction and vehicles that enter the detection area may not be detected. If the sensor or surrounding area is subject to a strong impact, always have the area inspected by your Toyota dealer.
- Do not disassemble the sensor.
- Do not attach accessories or stickers to the sensor or surrounding area on the bumper.
- Do not modify the sensor or surrounding area on the bumper.
- Do not paint the sensor or surrounding area on the bumper.

The electronically modulated air suspension allows the driver to control the vehicle's height in order to adjust for driving conditions. Select the desired height with the height control switch.

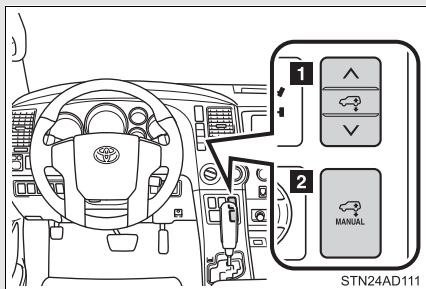

- 1 Height control switch
- 2 Height control mode select switch

Selecting vehicle height

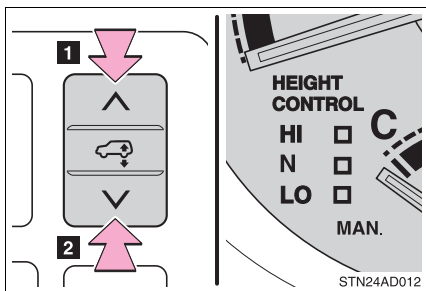

- 1 Higher
- 2 Lower

Vehicle height can be adjusted only when the engine is running. The height control indicator stops blinking, and comes on continuously to indicate that the mode shift is completed.

*: If equipped

■ Height modes

- N mode (normal mode): For ordinary driving

Normal height

- HI mode (high mode): For driving on bumpy roads

1.2 in. (30 mm) higher than the normal height

The HI mode is unavailable when the vehicle's speed exceeds 18 mph (30 km/h).

When the vehicle's speed exceeds 18 mph (30 km/h), the height will be adjusted to the normal height automatically.

- LO mode (low mode): For the ease of egress/ingress and loading luggage

1.2 in. (30 mm) lower than the normal height

The LO mode is unavailable when the vehicle's speed exceeds 8 mph (12 km/h).

When the vehicles speed exceeds 8 mph (12 km/h), the height will be adjusted to the normal height automatically.

Disabling the height control

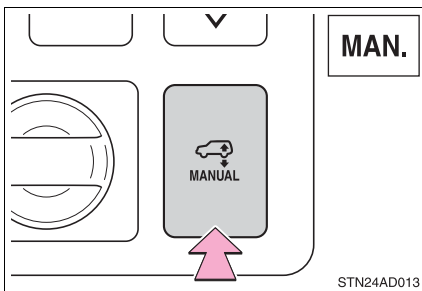

When the height control mode select switch is pressed, the vehicle height is fixed at the current height.

The height can be adjusted by pressing the height control switch.

When the vehicle's speed exceeds 18 mph (30 km/h), the height will be adjusted to the normal height automatically.

■ Automatic leveling function

Regardless of the number of occupants or the luggage load, vehicle height in any mode is always adjusted to a fixed height by the automatic leveling function.

■ When HI mode is selected

The vehicle height will change to N mode when driving at the speeds of 18 mph (30 km/h).

■ When LO mode is selected

- The vehicle height will change to N mode when vehicle speed exceeds 7 mph (12 km/h).
- This mode allows for easy access to the vehicle (getting in and out) and easy loading and unloading.

■ The electronically modulated air suspension will not operate in the following cases:

- The underbody of the vehicle is touching the surface of the road.
- The area around the suspension is covered with ice.

The height control indicators will blink, turn off and then turn on continuously to indicate that the electronically modulated air suspension is not operational.

To re-enable operation, turn off the engine and then restart it.

■ Even if you hear an operating noise

This does not indicate a problem in the electronically modulated air suspension.

■ If there is a problem somewhere in the electronically modulated air suspension

The height control MAN. indicator will behave as follows:

- The indicator will not come on when the engine switch is turned on.
- The indicator will blink.

Although the vehicle may be driven, have the vehicle inspected by your Toyota dealer.

 **CAUTION**

■ **The electronically modulated air suspension must be turned off in the following circumstances:**

Otherwise, the automatic leveling function may cause the vehicle's height to change, and you may catch part of your body in the vehicle, resulting in an unexpected accident:

- When driving through water such as shallow streams (Put the vehicle height in HI mode and turn off the electronically modulated air suspension. Drive at 18 mph [30 km/h] or slower.)
- When jacking up the vehicle, installing tire chains or tying the vehicle with chains/wires for transportation via flat bed truck (Turn the system to the manual mode and stop the engine.)
- When the vehicle must be towed (Put the vehicle height in N mode and turn the system to the manual mode.)
- When the vehicle gets stuck (Turn the system to the manual mode.)
- When disconnecting a trailer (Put the vehicle height in LO mode and turn the system to the manual mode.)

■ **Selecting the correct height mode**

Observe the following precautions to prevent accidents.

Failure to do so may cause damage to parts of the vehicle, as well as dangerous handling characteristics, which may lead to fatal or injury accidents.

- Before you lower the vehicle's height, check under the vehicle to make sure that no one is there.
- HI mode should only be used when driving on rough roads, for example when driving off-road.
Because the vehicle's center of gravity will become higher when in the mode, the vehicle may become unstable when turning abruptly, resulting in an accident.
- Do not select HI mode when you load cargo on the roof luggage carrier.
Because the vehicle's center of gravity will become higher when in the mode, the vehicle may become unstable when turning abruptly, resulting in an accident.

**NOTICE****■ Be careful in any place where overhead space is limited.**

When changing to a higher mode or after unloading, the vehicle height will rise. This may cause damage to the vehicle.

■ Do not select LO mode when driving on bumpy roads.

If the underbody of the vehicle touches a rugged road surface, the vehicle may be damaged.

■ Do not change the vehicle height frequently.

The compressor might overheat and cause the operation to stop.

■ When on the extremely uneven roads with rocks

Sometimes the vehicle height is not adjusted because it is judged as uneven road driving.

AVS (Adaptive Variable Suspension System)*

AVS controls the suspension according to the road and driving conditions. Selecting an optimum driving mode allows good vehicle posture and steering wheel operation.

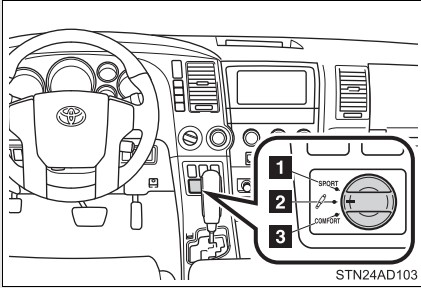

1 Sport mode

For winding mountain road driving or high speed driving.

2 Normal mode

For ordinary driving.

3 Comfort mode

For driving on a bumpy road.

■ Driving mode

- Sport mode is suitable for winding mountain road driving, high speed driving or towing a trailer.
- Normal mode is suitable for ordinary driving.

*: If equipped

2-4. Using other driving systems

Four-wheel drive system*

Use the front wheel drive control switch to select the following transfer modes.

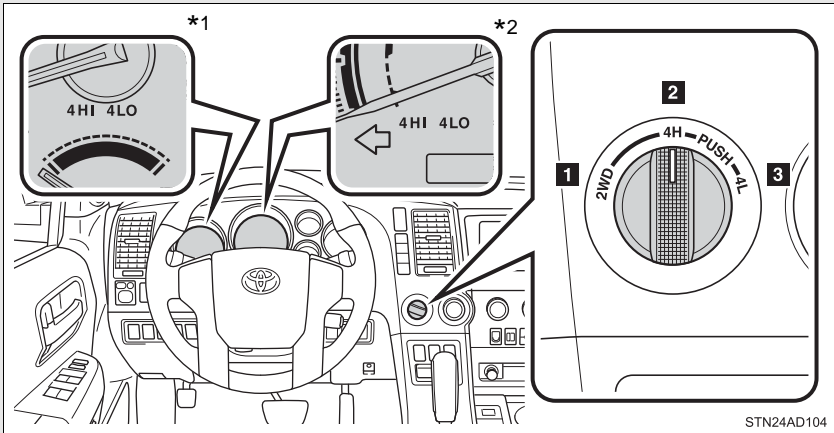

*1: Vehicles with multi-information display

*2: Vehicles without multi-information display

1 2WD (high speed position, two-wheel drive)

Normal driving.

2 4H (high speed position, four-wheel drive)

Greater traction than two wheel drive.

When you experience a loss of power, such as wheel slipping.

The 4HI indicator comes on.

3 4L (low speed position, four-wheel drive)

Driving requiring maximum power and traction such as climbing or descending steep hills, off-road driving and hard pulling in sand or mud, etc.

The 4LO indicator comes on.

Shifting between 4H and 4L

■ Shifting from 4H to 4L

STEP 1 Stop the vehicle completely.

STEP 2 Shift the shift lever to N.

STEP 3 Push and turn the front wheel drive control switch fully clockwise.

Maintain this condition until the 4LO indicator turns on.

■ Shifting from 4L to 4H

STEP 1 Stop the vehicle completely.

STEP 2 Shift the shift lever to N.

STEP 3 Turn the front wheel drive control switch fully counterclockwise.

Maintain this condition until the 4LO indicator turns off.

Center differential lock switch

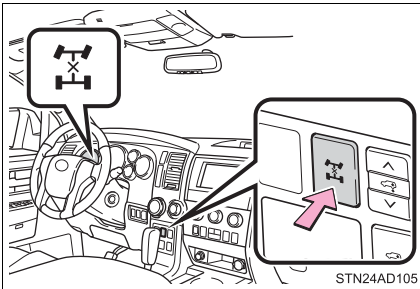

Use the center differential lock system if your wheels get stuck in a ditch, or when you are driving on a slippery or bumpy surface.

Unlock the center differential after the wheels have been freed, or after moving to a flat, non-slippery surface.

■ Shifting between 2WD and 4H

- Reduce your speed to less than 62 mph (100 km/h) and set the front wheel drive control switch between 2WD and 4H.

When the ambient temperature is 5.0°F (-15°C) or lower, shifting from 2WD to 4H cannot be performed with the vehicle speed above 43 mph (70 km/h).

- If the 4HI indicator does not go off when you shift from 4H to 2WD, drive straight ahead while accelerating or decelerating, or drive in reverse.

■ Four-wheel drive usage frequency

You should drive in four-wheel drive for at least 10 miles (16 km) each month.

This will assure that the front drive components are lubricated.

■ The center differential lock switch can be operated when

- The front wheel drive control switch is in the 4H or 4L position.
- The vehicle speed is less than 62 mph (100 km/h)

■ Center differential lock system

- When the front wheel drive control switch is in the 4L position and the center differential is locked, the VSC is automatically turned off.
- When the front wheel drive control switch is turned to the 2WD position, the center differential is automatically unlocked.
- If the operation is not completed, the center differential lock indicator blinks. If the indicator does not go off when unlocking the center differential, drive straight ahead while accelerating or decelerating, or drive in reverse.

■ **If the 4LO indicator, 4HI indicator or the center differential lock indicator blinks**

- If the 4LO indicator continues to blink when shifting between 4H and 4L, stop the vehicle completely, move the shift lever to N and operate the switch again.
- If the shift lever is moved before the 4LO indicator turns on/off, the transfer mode may not be shifted completely. The transfer mode disengages both the front and rear driveshafts from the powertrain and allows the vehicle to move regardless of the shift position. (At this time, the indicator blinks and the buzzer sounds.)

Therefore, the vehicle is free to roll even if the automatic transmission is in P. You or someone else could be seriously injured. You must complete the shifting of the transfer mode.

To complete the shifting, stop the vehicle completely, return the shift lever to N, and confirm that the shift was completed (The indicator turns on/off).

- If the engine coolant temperature is too low, transfer mode may not be able to shift. When the engine is warmer, turn the switch again.

If the 4LO indicator, 4HI indicator or the center differential lock indicator continues to blink even after attempting the above, there may be a malfunction in the engine, the brake system or the four-wheel drive system. In this case, you may not be able to shift between 2WD and 4H, 4H and 4L, and the center differential lock may not be operable. Have the vehicle inspected by your Toyota dealer immediately.

■ **Shifting to 4L position**

The VSC OFF indicator will come on.

If the center differential is locked, VSC is automatically turned off.

 CAUTION

■ **Shifting from 2WD to 4H while driving**

Never operate the front wheel drive control switch if the wheels are slipping. Stop the slipping or spinning before shifting.

■ **When the vehicle is parked**

If the shift lever is moved before the 4LO indicator turns on/off, the transfer mode may not be shifted completely. The transfer mode disengages both the front and rear driveshafts from the powertrain and allows the vehicle to move regardless of the shift position. (At this time, the indicator blinks and the buzzer sounds.)

Therefore, the vehicle is free to roll even if the automatic transmission is in P. You or someone else could be seriously injured. You must complete the shifting of the transfer mode before placing transmission in P. (→P. 239)

 NOTICE

■ **To prevent damage to the center differential**

- For normal driving on dry and hard surface roads, unlock the center differential.
- Unlock the center differential after the wheels are out of the ditch or off the loose or bumpy surface.
- Do not push the center differential lock switch when the vehicle is cornering or when its wheels are spinning freely off the ground.

AUTO LSD system

The AUTO LSD system aids traction by using the traction control system to control engine performance and braking when one of the rear wheels begins to spin.

The system should be used only when one of the rear wheels spinning occurs in a ditch or rough surface.

■ System operation

The system can be used on 2WD models and in 2WD mode on 4WD models.

The system is activated when driving at a speed under 62 mph (100 km/h).

The AUTO LSD system will be activated with the following two procedures.

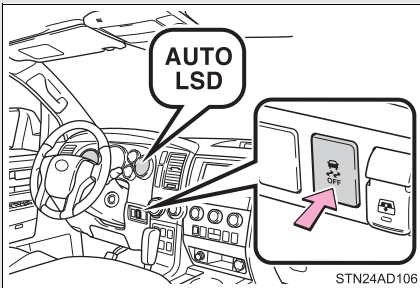

Press the VSC OFF switch briefly.

At this time, the AUTO LSD indicator will come on.

To turn off the system, push the switch again.

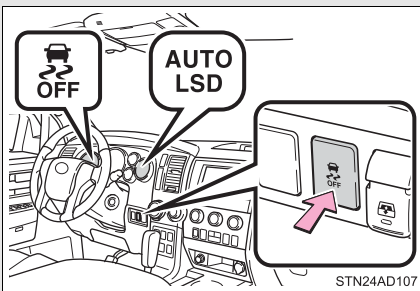

Stop the vehicle completely, and press the VSC OFF switch for more than 3 seconds.

At this time, VSC OFF and AUTO LSD indicators will come on simultaneously.

To turn off the system, push the switch again.

When the AUTO LSD system is operating

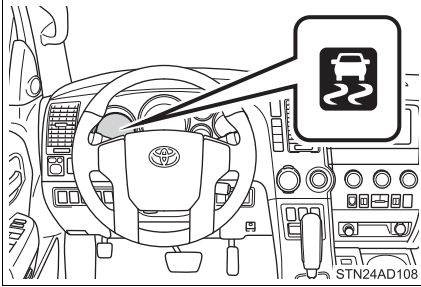

If the rear wheels spin, the slip indicator flashes to indicate that the AUTO LSD system has controlled the spinning of the rear wheels.

■ If the engine is turned off and restarted

The AUTO LSD system and the indicators are automatically turned off.

■ If the brake system overheats

The AUTO LSD system will cease operation, and the slip indicator will change from flashing to being on continuously to alert the driver. Stop the vehicle in a safe place. (There is no problem with continuing normal driving.)

The system will be automatically restored after a short time.

⚠ CAUTION

■ To avoid an accident

- Do not use the AUTO LSD system in conditions other than the above. A much greater steering effort and more careful cornering control will be required.
- Do not drive with the AUTO LSD system continuously turned on.

Driving assist systems

To help enhance driving safety and performance, the following systems operate automatically in response to various driving situations. Be aware, however, that these systems are supplementary and should not be relied upon too heavily when operating the vehicle.

■ **ABS (Anti-lock Brake System)**

Helps to prevent wheel lock when the brakes are applied suddenly, or if the brakes are applied while driving on a slippery road surface.

■ **Brake Assist**

Generates an increased level of braking force after the brake pedal is depressed, when the system detects a panic stop situation.

■ **VSC (Vehicle Stability Control)**

Helps the driver to control skidding when swerving suddenly or turning on slippery road surfaces.

■ **Trailer Sway Control**

Helps the driver to control trailer sway by selectively applying brake pressure for individual wheels and reducing engine torque when trailer sway is detected.

Trailer Sway Control is part of the VSC system and will not operate if VSC is turned off or experiences a malfunction.

■ **TRAC (Traction Control) for 2WD**

Maintains drive power and prevents the rear wheels from spinning when starting the vehicle or accelerating on slippery roads.

■ **A-TRAC (Active Traction Control) for 4WD**

Maintains drive power and prevents all wheels from spinning when starting the vehicle or accelerating on slippery roads.

When VSC/Trailer Sway Control/TRAC/A-TRAC are operating

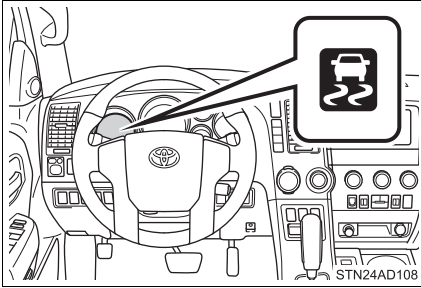

The slip indicator will flash while the VSC/Trailer Sway Control/TRAC/ A-TRAC systems are operating.

To disable VSC, Trailer Sway Control and/or TRAC (2WD models and 2WD mode on 4WD models)

If the vehicle gets stuck in fresh snow or mud, VSC, Trailer Sway Control and/or TRAC may reduce power from the engine to the wheels. You may need to turn the system off to enable you to rock the vehicle in order to free it.

■ TRAC OFF mode

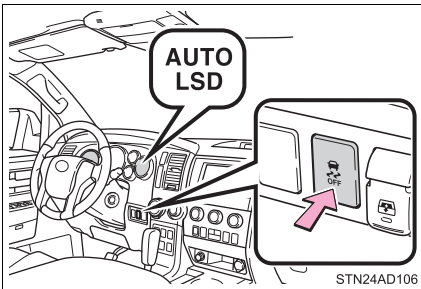

Press the VSC OFF switch briefly.

The AUTO LSD indicator will come on.

The system is in TRAC off, AUTO LSD on and VSC, Trailer Sway Control on mode.

Push the switch again to turn the system back on.

■ AUTO LSD mode

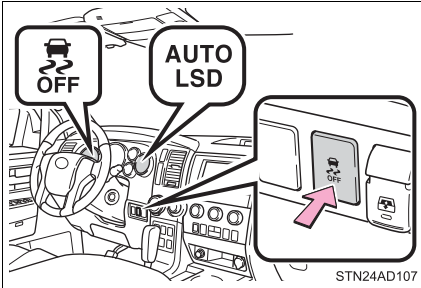

Stop the vehicle completely, and press the VSC OFF switch for more than 3 seconds, when the system is in the TRAC OFF mode.

The VSC OFF and AUTO LSD indicators will come on.

The system is in TRAC off, AUTO LSD on and VSC, Trailer Sway Control off mode.

■ VSC OFF mode

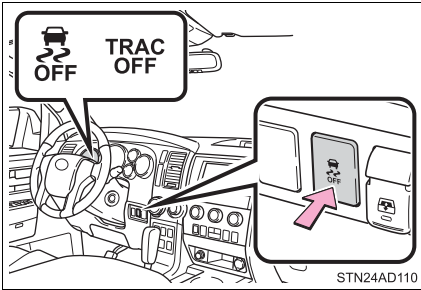

Stop the vehicle completely, and press the VSC OFF switch for more than 3 seconds, when the system is in the AUTO LSD mode.

The VSC OFF and TRAC OFF indicators will come on.

The system is all off mode.

To disable VSC, Trailer Sway Control and/or A-TRAC (4H mode on 4WD models)

If the vehicle gets stuck in fresh snow or mud, VSC, Trailer Sway Control and/or A-TRAC may reduce power from the engine to the wheels. You may need to turn the system off to enable you to rock the vehicle in order to free it.

■ A-TRAC OFF mode

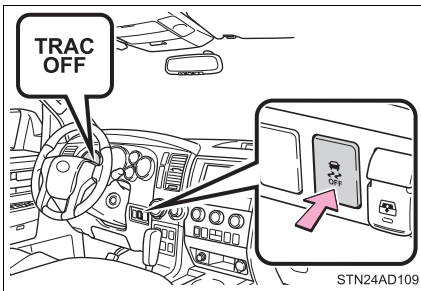

Press the VSC OFF switch briefly.

The TRAC OFF indicator will come on.

The system is in A-TRAC off and VSC, Trailer Sway Control on mode.

This mode can be used when the transfer mode is 4H mode and the center differential is unlocked.

Push the switch again to turn the system back on.

■ VSC OFF mode

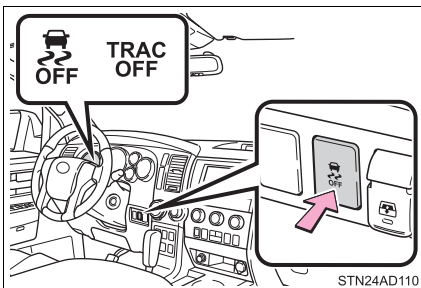

Stop the vehicle completely, and press the VSC OFF switch for more than 3 seconds.

The VSC OFF and TRAC OFF indicators will come on.

The system is all off mode.

To disable A-TRAC (4L mode on 4WD models)

If the vehicle gets stuck in fresh snow or mud, A-TRAC may reduce power from the engine to the wheels. You may need to turn the system off to enable you to rock the vehicle in order to free it.

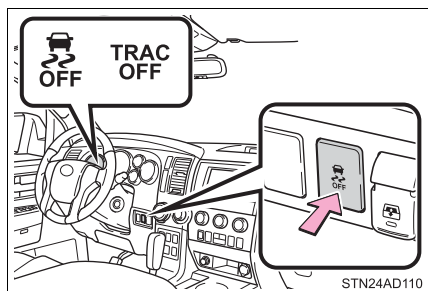

Stop the vehicle completely, and press the VSC OFF switch for more than 3 seconds.

The TRAC OFF indicator will come on.

The system is in all off mode.

Push the switch again to turn the system back on.

■ Automatic reactivation of TRAC, A-TRAC, VSC and Trailer Sway Control

Turning the engine switch off after turning off the TRAC, A-TRAC, VSC and Trailer Sway Control systems will automatically re-enable them.

■ Automatic A-TRAC reactivation (A-TRAC OFF mode)

With A-TRAC OFF mode, TRAC OFF indicator turn on. The A-TRAC system will turn on when the vehicle speed increases.

■ When the TRAC OFF indicator comes on even if the VSC OFF switch has not been pressed

TRAC cannot be operated. Contact your Toyota dealer.

■ Sounds and vibrations caused by the ABS, TRAC, A-TRAC, VSC, Trailer Sway Control and brake assist system

- A sound may be heard from the engine compartment when the engine is started and just after the vehicle begins to move. This sound does not indicate that a malfunction has occurred in any of these systems.
- Any of the following conditions may occur when the above systems are operating. None of these indicates that a malfunction has occurred.
 - Vibrations may be felt through the vehicle body and steering.
 - A motor sound may be heard after the vehicle comes to a stop.
 - The brake pedal may pulsate slightly after the ABS is activated.
 - The brake pedal may move down slightly after the ABS is activated.

■ If the brake system overheats

TRAC or A-TRAC will cease operation, and the slip indicator will change from flashing to being on continuously to alert the driver. Stop the vehicle in a safe place. (There is no problem with continuing normal driving.)

■ Shifting to 4L position

The VSC OFF indicator will come on.

If the center differential is locked, VSC and Trailer Sway Control are automatically turned off.

■ Power steering system operation sound

When you turn the engine switch to ON after the battery has been disconnected and reconnected, a sound may be heard from the engine compartment.

This does not indicate a malfunction.

CAUTION

Any of the following conditions may result in an accident which could cause death or serious injury.

■ The ABS does not operate effectively when

- The limits of tire gripping performance have been exceeded (such as excessively worn tires on a snow covered road).
- The vehicle hydroplanes while driving at high speed on the wet or slick road.

■ Stopping distance when the ABS is operating may exceed that of normal conditions

The ABS is not designed to shorten the vehicle's stopping distance. Always maintain a safe distance from the vehicle in front of you, especially in the following situations.

- When driving on dirt, gravel or snow-covered roads
- When driving with tire chains
- When driving over bumps in the road
- When driving over roads with potholes or roads with uneven roads

 CAUTION

■ **When VSC and Trailer Sway Control are activated**

The slip indicator flashes. Always drive carefully. Reckless driving may cause an accident. Exercise particular care when the indicator flashes.

■ **TRAC or A-TRAC may not operate effectively when**

Directional control and power may not be achievable while driving on slippery road surfaces, even if TRAC or A-TRAC is operating.

Do not drive the vehicle in conditions where stability and power may be lost.

■ **Replacing tires**

Make sure that all tires are of the same size, brand, tread pattern and total load capacity. In addition, make sure that the tires are inflated to the appropriate tire pressure level.

The ABS, VSC and Trailer Sway Control will not function correctly if different tires are fitted on the vehicle.

Contact your Toyota dealer for further information when replacing tires or wheels.

■ **Handling of tires and suspension**

Using tires with any kind of problem or modifying the suspension will affect the driving assist systems, and may cause the system to malfunction.

■ **Trailer Sway Control precaution**

The Trailer Sway Control system is not able to reduce trailer sway in all situations. Depending on many factors such as the conditions of the vehicle, trailer, road surface, and driving environment, the Trailer Sway Control system may not be effective. Refer to your trailer owner's manual for information on how to tow your trailer properly.

 CAUTION**■ If trailer sway occurs**

Observe the following precautions.

Failing to do so may cause death or serious injury.

- Firmly grip the steering wheel. Steer straight ahead.
Do not try to control trailer swaying by turning the steering wheel.
- Begin releasing the accelerator pedal immediately but very gradually to reduce speed.
Do not increase speed. Do not apply vehicle brakes.

If you make no extreme correction with the steering or brakes, your vehicle and trailer should stabilize. (→P. 286)

Off-road precautions

This vehicle belongs to the utility vehicle class, which has higher ground clearance and narrower tread in relation to the height of its center of gravity to make it capable of performing in a wide variety of off-road applications.

Off-road vehicle feature

- Specific design characteristics give it a higher center of gravity than ordinary passenger cars. This vehicle design feature causes this type of vehicle to be more likely to rollover. And, utility vehicles have a significantly higher rollover rate than other types of vehicles.
- An advantage of the higher ground clearance is a better view of the road allowing you to anticipate problems.
- It is not designed for cornering at the same speeds as ordinary passenger cars any more than low-slung sports cars designed to perform satisfactorily under off-road conditions. Therefore, sharp turns at excessive speeds may cause rollover.

 CAUTION**Off-road vehicle precautions**

Always observe the following precautions to minimize the risk of serious personal injury or damage to your vehicle:

- In a rollover crash, an unbelted person is significantly more likely to die than a person wearing a seat belt. Therefore, the driver and all passengers should always fasten their seat belts.
- Avoid sharp turns or abrupt maneuvers, if at all possible.
Failure to operate this vehicle correctly may result in loss of control or vehicle rollover causing death or serious injury.
- Loading cargo on the roof luggage carrier will make the center of the vehicle gravity higher. Avoid high speeds, sudden starts, sharp turns, sudden braking or abrupt maneuvers, otherwise it may result in loss of control or vehicle rollover due to failure to operate this vehicle correctly.
- Always slow down in gusty crosswinds. Because of its profile and higher center of gravity, your vehicle is more sensitive to side winds than an ordinary passenger car. Slowing down will allow you to have better control.
- When driving off-road or in rugged terrain, do not drive at excessive speeds, jump, make sharp turns, strike objects, etc. This may cause loss of control or vehicle rollover causing death or serious injury. You are also risking expensive damage to your vehicle's suspension and chassis.
- Do not drive horizontally across steep slopes. Driving straight up or straight down is preferred. Your vehicle (or any similar off-road vehicle) can tip over sideways much more easily than forward or backward.

Off-road driving

When driving your vehicle off-road, please observe the following precautions to ensure your driving enjoyment and to help prevent the closure of areas to off-road vehicles.

- Drive your vehicle only in areas where off-road vehicles are permitted to travel.
- Respect private property. Get owner's permission before entering private property.
- Do not enter areas that are closed. Honor gates, barriers and signs that restrict travel.
- Stay on established roads. When conditions are wet, driving techniques should be changed or travel delayed to prevent damage to roads.

■ Additional information for off-road driving

► For owners in U.S. mainland, Hawaii and Puerto Rico:

To obtain additional information pertaining to driving your vehicle off-road, consult the following organizations.

- State and Local Parks and Recreation Departments
- State Motor Vehicle Bureau
- Recreational Vehicle Clubs
- U.S. Forest Service and Bureau of Land Management

 **CAUTION****■ Off-road driving precautions**

Always observe the following precautions to minimize the risk of serious personal injury or damage to your vehicle:

- Drive carefully when off the road. Do not take unnecessary risks by driving in dangerous places.
- Do not grip the steering wheel spokes when driving off-road. A bad bump could jerk the wheel and injure your hands. Keep both hands and especially your thumbs on the outside of the rim.
- Always check your brakes for effectiveness immediately after driving in sand, mud, water or snow.
- After driving through tall grass, mud, rock, sand, rivers, etc., check that there is no grass, bush, paper, rags, stone, sand, etc. adhering or trapped on the underbody. Clear off any such matter from the underbody. If the vehicle is used with these materials trapped or adhering to the underbody, a breakdown or fire could occur.
- In a rollover crash, an unbelted person is significantly more likely to die than a person wearing a seat belt. Therefore, the driver and all passengers should fasten their seat belts whenever the vehicle is moving.
- When driving off-road or in rugged terrain, do not drive at excessive speeds, jump, make sharp turns, strike objects, etc. This may cause loss of control or vehicle rollover causing death or serious injury. You are also risking expensive damage to your vehicle's suspension and chassis.

 NOTICE

■ **To prevent the water damage**

- Take all necessary safety measures to ensure that water damage to the engine or other components does not occur.
- Water entering the engine air intake will cause severe engine damage.
- Water entering the automatic transmission will cause deterioration in shift quality, locking up of your transmission accompanied by vibration, and ultimately damage.
- Water can wash the grease from wheel bearings, causing rusting and premature failure, and may also enter the differentials, transmission and transfer case, reducing the gear oil's lubricating qualities.

■ **When you drive through water**

If driving through water, such as when crossing shallow streams, first check the depth of the water and the bottom of the river bed for firmness. Drive slowly and avoid deep water.

■ **Inspection after off-road driving**

- Sand and mud that has accumulated in brake drums and around brake discs may affect braking efficiency and may damage brake system components.
- Always perform a maintenance inspection after each day of off-road driving that has taken you through rough terrain, sand, mud, or water. For scheduled maintenance information, refer to the "Scheduled Maintenance Guide" or "Owner's Manual Supplement".

2-5. Driving information

Cargo and luggage

Take notice of the following information about storage precautions, cargo capacity and load.

- Stow cargo and luggage in the luggage compartment whenever possible.
- Be sure all items are secured in place.
- Be careful to keep the vehicle level. Placing the weight as far forward as possible helps maintain vehicle balance.
- For better fuel economy, do not carry unnecessary weight.

Capacity and distribution

Cargo capacity depends on the total weight of the occupants.

(Cargo capacity) = (Total load capacity) – (Total weight of occupants)

Steps for Determining Correct Load Limit—

- (1) Locate the statement “The combined weight of occupants and cargo should never exceed XXX kg or XXX lbs.” on your vehicle’s placard.
- (2) Determine the combined weight of the driver and passengers that will be riding in your vehicle.
- (3) Subtract the combined weight of the driver and passengers from XXX kg or XXX lbs.
- (4) The resulting figure equals the available amount of cargo and luggage load capacity.
For example, if the “XXX” amount equals 1400 lbs. and there will be five 150 lb passengers in your vehicle, the amount of available cargo and luggage load capacity is 650 lbs. (1400 – 750 (5 × 150) = 650 lbs.)
- (5) Determine the combined weight of luggage and cargo being loaded on the vehicle. That weight may not safely exceed the available cargo and luggage load capacity calculated in Step 4.

- (6) If your vehicle will be towing a trailer, load from your trailer will be transferred to your vehicle. Consult this manual to determine how this reduces the available cargo and luggage load capacity of your vehicle.

Calculation formula for your vehicle

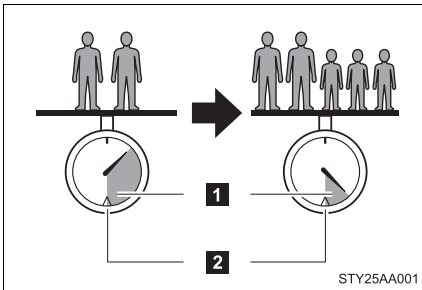

1 Cargo capacity

2 Total load capacity (vehicle capacity weight) (→P. 513)

When 2 people with the combined weight of A lb. (kg) are riding in your vehicle, which has a total load capacity (vehicle capacity weight) of B lb. (kg), the available amount of cargo and luggage load capacity will be C lb. (kg) as follows:

$$B^{*2} \text{ lb. (kg)} - A^{*1} \text{ lb. (kg)} = C^{*3} \text{ lb. (kg)}$$

*1: A = Weight of people

*2: B = Total load capacity

*3: C = Available cargo and luggage load

In this condition, if 3 more passengers with the combined weight of D lb. (kg) get on, the available cargo and luggage load will be reduced E lb. (kg) as follows:

$$C \text{ lb. (kg)} - D^{*4} \text{ lb. (kg)} = E^{*5} \text{ lb. (kg)}$$

*4: D = Additional weight of people

*5: E = Available cargo and luggage load

As shown in the above example, if the number of occupants increases, the cargo and luggage load will be reduced by an amount that equals the increased weight due to the additional occupants. In other words, if an increase in the number of occupants causes an excess of the total load capacity (combined weight of occupants plus cargo and luggage load), you must reduce the cargo and luggage on your vehicle.

CAUTION

■ Things that must not be carried in the luggage compartment

The following things may cause a fire if loaded in the luggage compartment.

- Receptacles containing gasoline
- Aerosol cans

■ Storage precautions

Observe the following precautions.

Failure to do so may result in death or serious injury.

- Do not stack anything in the luggage compartment higher than the seatbacks.
Such items may be thrown about and possibly injure people in the vehicle during sudden braking or in an accident.
- Do not place cargo or luggage in or on the following locations as the item may get under the brake or accelerator pedal and prevent the pedals from being depressed properly, block the driver's vision, or hit the driver or passengers, causing an accident.
 - Driver's feet
 - Front passenger or rear seats (when stacking items)
 - Instrument panel
 - Dashboard
 - Auxiliary box or tray that has no lid
- Secure all items in the occupant compartment, as they may shift and injure someone during sudden braking, sudden swerving or an accident.

CAUTION

Storage precautions

- Never allow anyone to ride in the luggage compartment. It is not designed for passengers. They should ride in their seats with their seat belts properly fastened. Otherwise, they are much more likely to suffer death or serious bodily injury, in the event of sudden braking, sudden swerving or an accident.

Capacity and distribution

- Do not exceed the maximum axle weight rating or the total vehicle weight rating.
- Even if the total load of occupant's weight and the cargo load is less than the total load capacity, do not apply the load unevenly. Improper loading may cause deterioration of steering or braking control which may cause death or serious injury.

Roof luggage carrier precautions

To use the roof rails as a roof luggage carrier, you must fit the roof rails with two or more genuine Toyota cross rails or their equivalent.

When you load cargo on the roof luggage carrier, observe the following:

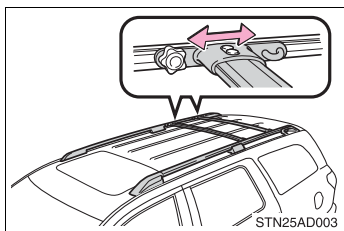

- Place the cargo so that its weight is distributed evenly between the front and rear axles.
- If loading long or wide cargo never exceed the vehicle overall length or width. (→P. 512)

- Before driving, make sure the cargo is securely fastened on the roof luggage carrier.
- Loading cargo on the roof luggage carrier will make the center of the vehicle gravity higher. Avoid high speeds, sudden starts, sharp turns, sudden braking or abrupt maneuvers, otherwise it may result in loss of control or vehicle rollover due to failure to operate this vehicle correctly and result in death or serious injury.

 **CAUTION****■ Roof luggage carrier precautions**

- If driving for a long distance, on rough roads, or at high speeds, stop the vehicle now and then during the trip to make sure the cargo remains in its place.
- Do not exceed 150 lb. (68 kg) cargo weight on the roof luggage carrier.

■ Cross rail adjustment

Make sure the cross rails are locked securely by pushing forward and rearward them.

Failure to do so may cause an unexpected accident or severe injury in the event of emergency braking or a collision.

2-5. Driving information

Vehicle load limits

Vehicle load limits include total load capacity, seating capacity, TWR (Trailer Weight Rating) and cargo capacity.

■ **Total load capacity (vehicle capacity weight): (→P. 513)**

Total load capacity means the combined weight of occupants, cargo and luggage.

■ **Seating capacity:**

With separated type second seat—

7 occupants (Front 2, Rear 5)

With bench type second seat—

8 occupants (Front 2, Rear 6)

Seating capacity means the maximum number of occupants whose estimated average weight is 150 lb. (68 kg) per person.

Even if the number of occupants are within the seating capacity, do not exceed the total load capacity.

■ **TWR (Trailer Weight Rating): (→P. 275, 513)**

TWR means the maximum gross trailer weight (trailer weight plus its cargo weight) that your vehicle is able to tow.

■ **Cargo capacity**

Cargo capacity may increase or decrease depending on the weight and the number of occupants.

■ **Total load capacity and seating capacity**

These details are also described on the tire and loading information label. (→P. 423)

 CAUTION**■ Overloading the vehicle**

Do not overload the vehicle.

It may not only cause damage to the tires, but also degrade steering and braking ability, resulting in an accident.

2-5. Driving information

Winter driving tips

Carry out the necessary preparations and inspections before driving the vehicle in winter. Always drive the vehicle in a manner appropriate to the prevailing weather conditions.

■ Pre-winter preparations

- Use fluids that are appropriate to the prevailing outside temperatures.
 - Engine oil
 - Engine coolant
 - Washer fluid
- Have a service technician inspect the level and specific gravity of battery electrolyte.
- Have the vehicle fitted with four snow tires or purchase a set of tire chains for the rear tires.

Ensure that all tires are the same size and brand, and that chains match the size of the tires.

■ Before driving the vehicle

Perform the following according to the driving conditions.

- Do not try to forcibly open a window, scrape an outside rear view mirror surface or move a wiper or outside rear view mirror that is frozen. Pour warm water over the frozen area to melt the ice. Wipe away the water immediately to prevent it from freezing.
- To ensure proper operation of the climate control system fan, remove any snow that has accumulated on the air inlet vents in front of the windshield.
- Remove any ice that has accumulated on the vehicle chassis.
- Periodically check for and remove any excess ice or snow that may have accumulated in the wheel well or on the brakes.

■ When driving the vehicle

Accelerate the vehicle slowly and drive at a reduced speed suitable to road conditions.

■ When parking the vehicle

Park the vehicle and move the shift lever to P without setting the parking brake. The parking brake may freeze up, preventing it from being released. If necessary, block the wheels to prevent inadvertent sliding or creeping.

■ Refueling (Flex-fuel vehicles)

Observe the following precautions when switching fuels, in order to maintain starting and driving performance.

- Do not change fuels when the fuel level is 1/4 or less.
- Always add at least 2.6 gal. (10 L) of fuel.
- After fulling up with fuel, warm up the engine or drive the vehicle for at least 5 minutes or 7 miles (11 km).
- Do not accelerate rapidly immediately after refueling.

Selecting tire chains

Use the correct tire chain size when mounting the snow chains. Chain size is regulated for each tire size.

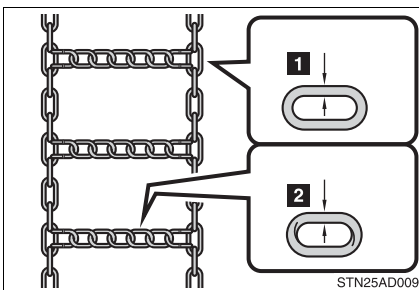

- 1** Side chain
0.2 in. (5 mm) in diameter
- 2** Cross chain
0.25 in. (6.3 mm) in diameter

Regulations on the use of snow chains

- Regulations regarding the use of tire chains vary according to location and type of road. Always check local regulations before installing chains.
- Install the chains on the rear tires.
- Retighten the chains after driving 1/4 - 1/2 mile (0.5 - 1.0 km).

■ Snow chain installation

Observe the following precautions when installing and removing chains.

- Install and remove tire chains in a safe location.
- Install tire chains on the rear tires only. Do not install tire chains on the front tires.
- Install tire chains following the instructions provided in the accompanying instructions.

CAUTION

■ Driving with snow tires

Observe the following precautions to reduce the risk of accidents.

Failing to do so may result in a loss of vehicle control and cause death or serious injury.

- Use tires of the size specified for your vehicle.
- Maintain the recommended level of air pressure.
- Do not drive in excess of 75 mph (120 km/h) regardless of the type of snow tires being used.
- Snow tires should be installed on all wheels.
- Do not mix tires of different makes, models, tread patterns or treadwear.

 CAUTION**■ Driving with snow chains**

Observe the following precautions to reduce the risk of accidents. Failing to do so may result in the vehicle being unable to be driven safely, and may cause death or serious injury.

- Do not drive in excess of the speed limit specified for the tire chains being used or 30 mph (50 km/h), whichever is lower.
- Avoid driving on bumpy road surfaces or over potholes.
- Avoid sudden turns and braking.
- Slow down sufficiently before entering a curve to ensure that vehicle control is maintained.

 NOTICE**■ Repairing or replacing snow tires**

Request repairs of and obtain replacement snow tires from Toyota dealers or legitimate tire retailers.

This is because the removal and attachment of snow tires affects the operation of the tire pressure warning valves and transmitters.

■ Fitting tire chains

The tire pressure warning valves and transmitters may not function correctly when tire chains are fitted.

Trailer towing

Your vehicle is designed primarily as a passenger-and-load-carrying vehicle. Towing a trailer can have an adverse impact on handling, performance, braking, durability, and fuel consumption. For your safety and the safety of others, you must not overload your vehicle or trailer. You must also ensure that you are using appropriate towing equipment, that the towing equipment has been installed correctly and used properly, and that you employ the requisite driving habits.

Vehicle-trailer stability and braking performance are affected by trailer stability, brake performance and setting, trailer brakes, the hitch and hitch systems (if equipped).

To tow a trailer safely, use extreme care and drive the vehicle in accordance with your trailer's characteristics and operating conditions.

Toyota warranties do not apply to damage or malfunction caused by towing a trailer for commercial purposes.

Contact your Toyota dealer for further information about additional requirements such as towing kits, etc.

Towing related terms

■ GCWR (Gross Combination Weight Rating)

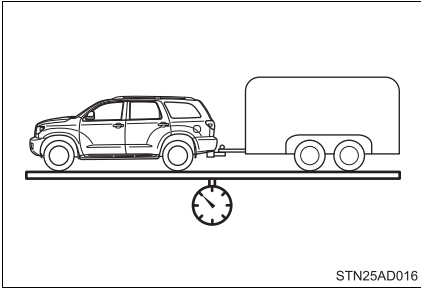

The maximum allowable gross combination weight. The gross combination weight is the sum of the total vehicle weight (including the occupants, cargo and any optional equipment installed on the vehicle) and the weight of the trailer being towed (including the cargo in the trailer).

■ GVWR (Gross Vehicle Weight Rating)

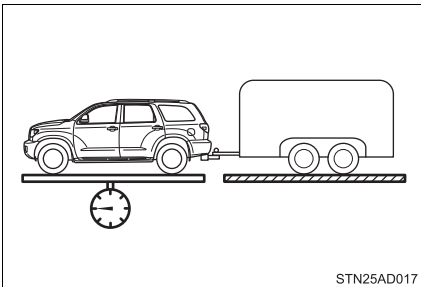

The maximum allowable gross vehicle weight. The gross vehicle weight is the total weight of the vehicle. When towing a trailer, it is the sum of the vehicle weight (including the occupants, cargo and any optional equipment installed on the vehicle) and the tongue weight.

■ GAWR (Gross Axle Weight Rating)

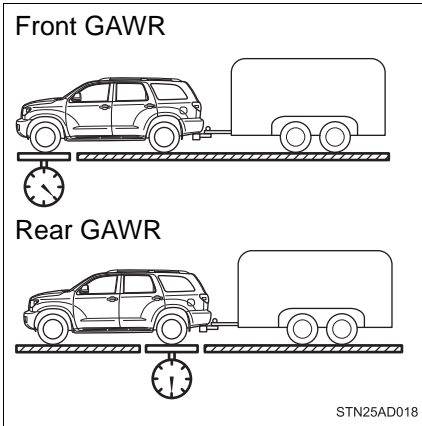

The maximum allowable gross axle weight. The gross axle weight is the load placed on each axle (front and rear).

■ TWR (Trailer Weight Rating)

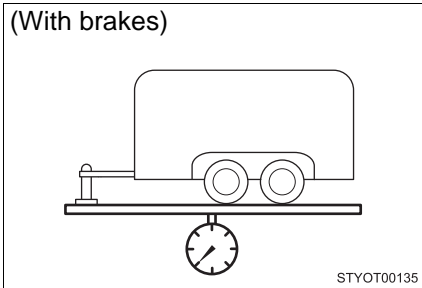

The maximum allowable gross trailer weight. The gross trailer weight is the sum of the trailer weight and the weight of the cargo in the trailer.

TWR is calculated assuming base vehicle with one driver, one front passenger, towing package (if available), hitch and hitch systems (if required).

Additional optional equipment, passengers and cargo in the vehicle will reduce the trailer weight rating so as not to exceed GCWR, GVWR and GAWR.

If the gross trailer weight exceeds 3000 lb. (1360 kg), it is recommended to use a trailer with 2 or more axles.

■ Unbraked TWR (Unbraked Trailer Weight Rating)

(Without brakes)

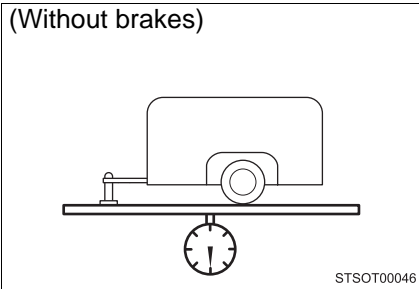

The trailer weight rating for towing a trailer without a trailer service brake system.

■ Tongue Weight

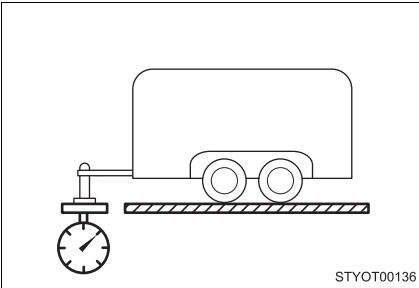

The load placed on the trailer hitch ball. (→P. 276)

Weight limits

- The gross trailer weight must never exceed the TWR described in the table. (→P. 275)
- The gross combination weight must never exceed the GCWR described in the table. (→P. 275)

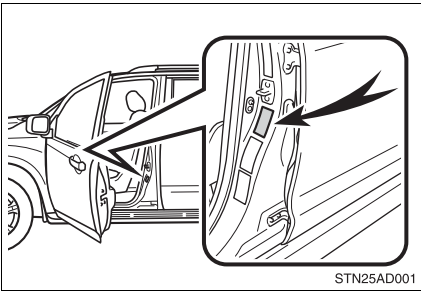

- The gross vehicle weight must never exceed the GVWR indicated on the Certification Label.
- The gross axle weight on each axle must never exceed the GAWR indicated on the Certification Label.

- If the gross trailer weight is over the unbraked TWR, trailer service brakes are required.
- If the gross trailer weight is over 2000 lb. (907 kg), a sway control device with sufficient capacity is required.
- If the gross trailer weight is over 5000 lb. (2268 kg), a weight distributing hitch with sufficient capacity is required.

GCWR, TWR and Unbraked TWR

Confirm that the gross trailer weight, gross combination weight, gross vehicle weight, gross axle weight and tongue weight are all within the limits.

■ GCWR* and TWR*

Model code *1	Engine	Driving system	GCWR	TWR
USK60L-GKTSKA	5.7L V8 (3UR-FE) engine	2WD	13600 lb. (6169 kg)	7400 lb. (3357 kg)
USK60L-GKTLKA				7300 lb. (3311 kg)
USK60L-GKTZKA				7200 lb. (3266 kg)
USK65L-GKTSKA	5.7L V8 (3UR-FBE) engine	4WD	13600 lb. (6169 kg)	7100 lb. (3245 kg)
USK65L-GKTLKA				7100 lb. (3230 kg)
USK65L-GKTZKA				7000 lb. (3200 kg)
USK65L-GKTSGA				7100 lb. (3221 kg)
USK65L-GKTLGA				
USK65L-GKTZGA	7000 lb. (3175 kg)			

*1: The model code is indicated on the Certification Label. (→P. 514)

■ Unbraked TWR*

1000 lb. (453 kg)

*: These models meet the tow-vehicle trailering requirement of SAE International per SAE J2807.

Trailer Tongue Weight

- A recommended tongue weight varies in accordance with the types of trailers or towing as described below.
- To ensure the recommended values shown below, the trailer must be loaded by referring to the following instructions.

- Tongue Weight

The gross trailer weight should be distributed so that the tongue weight is 9% to 11%. (Tongue weight /Gross trailer weight x 100 = 9% to 11%)

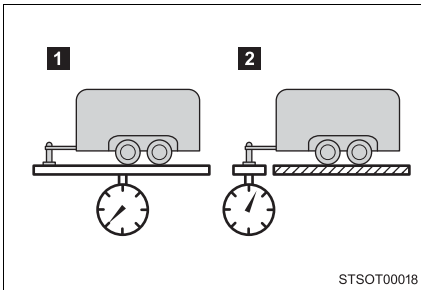

1 Gross trailer weight

2 Tongue weight

If using a weight distributing hitch when towing, return the front axle to the same weight as before the trailer connection.

If front axle weight cannot be measured directly, measure the front fender height above the front axle before connection. Adjust weight distributing hitch torque until front fender is returned to the same height as before connection.

The gross trailer weight, gross axle weight and tongue weight can be measured with platform scales found at a highway weighing station, building supply company, trucking company, junk yard, etc.

Hitch

Trailer hitch assemblies have different weight capacities. Toyota recommends the use of Toyota hitch/bracket for your vehicle. For details, contact your Toyota dealer.

- If you wish to install a trailer hitch, contact your Toyota dealer.
- Use only a hitch that conforms to the gross trailer weight requirement of your vehicle.
- Follow the directions supplied by the hitch manufacturer.
- Lubricate the hitch ball with a light coating of grease.
- Remove the trailer hitch whenever you are not towing a trailer. After removing the hitch, seal any mounting hole in the vehicle body to prevent entry of any substances into the vehicle.

Selecting trailer ball

Use the correct trailer ball for your application.

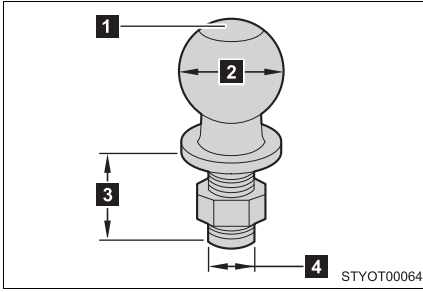

1 Trailer ball load rating

Matches or exceeds the gross trailer weight rating of the trailer.

2 Ball diameter

Matches the size of the trailer coupler. Most couplers are stamped with the required trailer ball size.

Trailer class	Typical trailer ball size
IV	2 5/16 in.
II and III	2 in.
I	1 7/8 in.

3 Shank length

Protrudes beyond the bottom of the lock washer and nut by at least 2 threads.

4 Shank diameter

Matches the ball mount hole diameter size.

Positions for towing hitch receiver

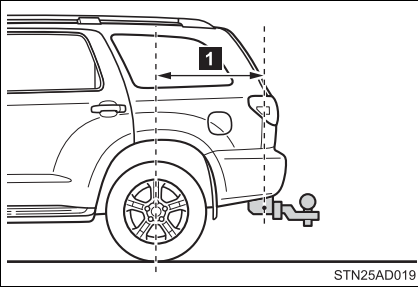

- 1 Hitch receiver pin hole position: 46.2 in. (1172.3 mm)

Connecting trailer lights

Use the wire harness stored in the rear end under the vehicle body.

- ▶ 4 pin connector

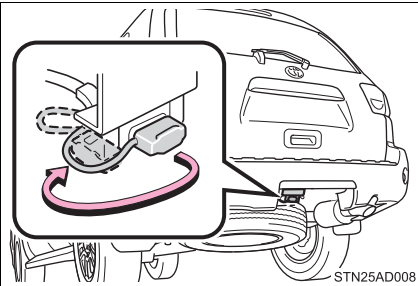

- ▶ 4 pin, 7 pin connectors

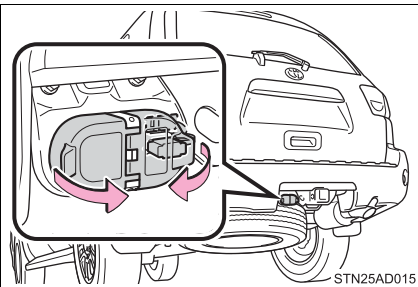

■ Service connector for towing brake controller (with towing package)

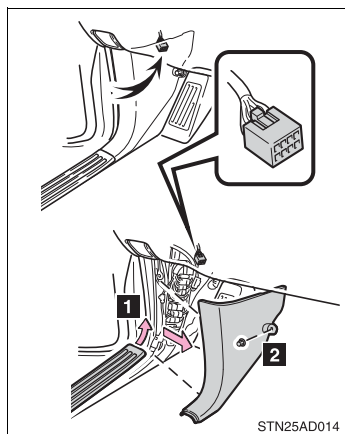

Your vehicle is equipped with a service connector for the trailer brake controller as shown.

Access the service connector.

- 1** Remove the scuff plate.
- 2** Remove the clip (screw type) and trim board.

Connecting and disconnecting a trailer (vehicles with electronically modulated air suspension)

If a height control system is installed in your vehicle, you have to connect and disconnect your trailer more carefully.

● Connecting

- STEP 1** Set the height control of electronically modulated air suspension system to N mode.
- STEP 2** Turn off the engine, or set the electronically modulated air suspension system to MAN. (manual).
- STEP 3** Connect the trailer.
- STEP 4** Turn the engine switch to the START position and start the engine.
- STEP 5** Press the height control mode select switch to cancel the MAN. (manual) condition that was set on **STEP 2**.
- STEP 6** Check that the MAN. indicator turns off.
Set the height control of electronically modulated air suspension system to N mode.

● Disconnecting

- STEP 1** Set the height control of electronically modulated air suspension system to N mode.
- STEP 2** Set the electronically modulated air suspension system to MAN. (manual).
- STEP 3** Turn off the engine.
- STEP 4** Set the supporting leg of the trailer on the ground and raise the hitch by 4 in. (100 mm).
- STEP 5** Turn the engine switch to the START position and start the engine.
- STEP 6** Press the height control mode select switch to cancel the MAN. (manual) condition that was set on **STEP 2**. Check that the MAN. indicator turns off.
- STEP 7** Wait until vehicle height is stabilized.
- STEP 8** Make sure the hitch is disconnected. If the hitch does not disconnect, raise the hitch higher and repeat steps 2 through 7.
- STEP 9** Move the vehicle forward in LO mode where the hitch does not touch anything in N mode.
- STEP 10** Set the height control of electronically modulated air suspension system to N mode.

Trailer towing tips

Your vehicle will handle differently when towing a trailer. Help to avoid an accident, death or serious injury, keep the following in mind when towing:

- Speed limits for towing a trailer vary by state or province. Do not exceed the posted towing speed limit.
- Toyota recommends that the vehicle-trailer speed limit is 65 mph (104 km/h) on a flat, straight, dry road. Do not exceed this limit, the posted towing speed limit or the speed limit for your trailer as set forth in your trailer owner's manual, whichever is lowest. Instability of the towing vehicle-trailer combination (trailer sway) increases as speed increases. Exceeding speed limits may cause loss of control.
- Before starting out, check the trailer lights, tires and the vehicle-trailer connections. Recheck after driving a short distance.
- Practice turning, stopping and reversing with the trailer attached in an area away from traffic until you become accustomed to the feel of the vehicle-trailer combination.
- Reversing with a trailer attached is difficult and requires practice. Grip the bottom of the steering wheel and move your hand to the left to move the trailer to the left. Move your hand to the right to move the trailer to the right. (This is generally opposite to reversing without a trailer attached.) Avoid sharp or prolonged turning. Have someone guide you when reversing to reduce the risk of an accident.
- As stopping distance is increased when towing a trailer, vehicle-to-vehicle distance should be increased. For each 10 mph (16 km/h) of speed, allow at least one vehicle and trailer length.
- Avoid sudden braking as you may skid, resulting in the trailer jack-knifing and loss of vehicle control. This is especially true on wet or slippery surfaces.

- Avoid jerky starts or sudden acceleration.
- Avoid jerky steering and sharp turns, and slow down before making a turn.
- Note that when making a turn, the trailer wheels will be closer than the vehicle wheels to the inside of the turn. Compensate by making a wider than normal turning radius.
- Slow down before making a turn, in crosswinds, on wet or slippery surfaces, etc.
Increasing vehicle speed can destabilize the trailer.
- Take care when passing other vehicles. Passing requires considerable distance. After passing a vehicle, do not forget the length of your trailer, and be sure you have plenty of room before changing lanes.
- To maintain engine braking efficiency and charging system performance when using engine braking, do not use the transmission in D.
Transmission shift range position must be in 4 in the S mode.
- Instability happens more frequently when descending steep or long downhill grades. Before descending, slow down and downshift. Do not make sudden downshifts while descending steep or long downhill grades.
- Avoid holding the brake pedal down too long or applying the brakes too frequently. This could cause the brakes to overheat and result in reduced braking efficiency.
- Due to the added load of the trailer, your vehicle's engine may overheat on hot days (at temperatures over 85°F [30°C]) when driving up a long or steep grade. If the engine coolant temperature gauge indicates overheating, immediately turn off the air conditioning (if in use), pull your vehicle off the road and stop in a safe spot. (→P. 504)

- Always place wheel blocks under both the vehicle's and the trailer's wheels when parking. Apply the parking brake firmly, and put the transmission in P. Avoid parking on a slope, but if unavoidable, do so only after performing the following:

STEP 1 Apply the brakes and keep them applied.

STEP 2 Have someone place wheel blocks under both the vehicle's and trailer's wheels.

STEP 3 When the wheel blocks are in place, release the brakes slowly until the blocks absorb the load.

STEP 4 Apply the parking brake firmly.

STEP 5 Shift into P and turn off the engine.

- When restarting after parking on a slope:

STEP 1 With the transmission in P, start the engine. On vehicles with an automatic transmission, be sure to keep the brake pedal pressed.

STEP 2 Shift into a forward gear. If reversing, shift into R.

STEP 3 Release the parking brake and brake pedal, and slowly pull or back away from the wheel blocks. Stop and apply the brakes.

STEP 4 Have someone retrieve the blocks.

■ Matching trailer ball height to trailer coupler height

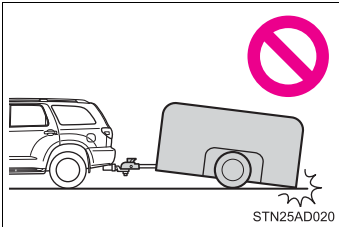

No matter which class of tow hitch applies, for a more safe trailer hookup, the trailer ball setup must be the proper height for the coupler on the trailer.

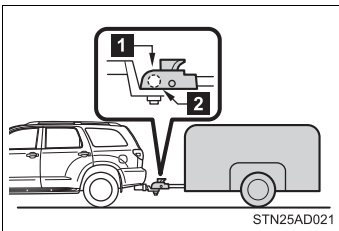

- 1** Coupler
- 2** Trailer ball

■ Before towing

Check that the following conditions are met:

- Ensure that your vehicle's tires are properly inflated. (→P. 521)
- Trailer tires are inflated according to the trailer manufacturer's recommendation.
- All trailer lights work as required by law.
- All lights work each time you connect them.
- The trailer ball is set at the proper height for the coupler on the trailer.
- The trailer is level when it is hitched.
Do not drive if the trailer is not level, and check for improper tongue weight, overloading, worn suspension, or other possible causes.
- The trailer cargo is securely loaded.
- The rear view mirrors conform to all applicable federal, state/provincial or local regulations. If they do not, install rear view mirrors appropriate for towing purposes.
- Depress TOW/HAUL button (if equipped)

■ AVS (adaptive variable suspension system) (if equipped)

The suspension can be switched for improvement in driveability. (→P. 238)

■ Break-in schedule

If your vehicle is new or equipped with any new power train components (such as an engine, transmission, differential or wheel bearing), Toyota recommends that you do not tow a trailer until the vehicle has been driven for over 500 miles (800 km).

After the vehicle has been driven for over 500 miles (800 km), you can start towing. However, for the next 500 miles (800 km), drive the vehicle at a speed of less than 50 mph (80 km/h) when towing a trailer, and avoid full throttle acceleration.

■ Maintenance

- If you tow a trailer, your vehicle will require more frequent maintenance due to the additional load. (See “Owner’s Warranty Information Booklet” or “Scheduled Maintenance Guide/Owner’s Manual Supplement”.)
- Retighten the fixing bolts of the towing ball and bracket after approximately 600 miles (1000 km) of trailer towing.

■ If trailer sway occurs

One or more factors (crosswinds, passing vehicles, rough roads, etc.) can adversely affect handling of your vehicle and trailer, causing instability.

- If trailer swaying occurs:

- Firmly grip the steering wheel. Steer straight ahead.
Do not try to control trailer swaying by turning the steering wheel.
- Begin releasing the accelerator pedal immediately but very gradually to reduce speed.
Do not increase speed. Do not apply vehicle brakes.

If you make no extreme correction with the steering or brakes, your vehicle and trailer should stabilize. (if enabled, Trailer Sway Control can also help to stabilize the vehicle and trailer.)

- After the trailer swaying has stopped:

- Stop in a safe place. Get all occupants out of the vehicle.
- Check the tires of the vehicle and the trailer.
- Check the load in the trailer.
Make sure the load has not shifted.
Make sure the tongue weight is appropriate, if possible.
- Check the load in the vehicle.
Make sure the vehicle is not overloaded after occupants get in.

If you cannot find any problems, the speed at which trailer swaying occurred is beyond the limit of your particular vehicle-trailer combination.

Drive at a lower speed to prevent instability. Remember that swaying of the towing vehicle-trailer increases as speed increases.

CAUTION

■ Trailer towing precautions

- To tow a trailer safely, use extreme care and drive the vehicle in accordance with the trailer's characteristics and operating conditions. Failure to do so could cause an accident resulting in death or serious injury. Vehicle stability and braking performance are affected by trailer stability, brake setting and performance, and the hitch. Your vehicle will handle differently when towing a trailer.
- Vehicles with electronically modulated air suspension: Set the vehicle height to the LO mode and turn off the rear height control air suspension when you connect a trailer, otherwise the vehicle height may change due to the automatic leveling function, and you may catch part of your body in the vehicle, resulting in an accident.

■ To avoid accident or injury

- Do not exceed the TWR, unbraked TWR, GCWR, GVWR or GAWR.
- If the gross trailer weight is over 2000 lb. (907 kg), a sway control device with sufficient capacity is required.
- If the gross trailer weight is over 5000 lb. (2268 kg), a weight distributing hitch with sufficient capacity is required.
- Adjust the tongue weight within the appropriate range. Place heavier loads as close to the trailer axle as possible.
- Do not exceed 65 mph (104 km/h), the posted towing speed limit or the speed limit for your trailer as set forth in your trailer owner's manual, whichever is lowest. Slow down sufficiently before making a turn, in crosswinds, on wet or slippery surface, etc. to help avoid an accident. If you experience a vehicle-trailer instability from reducing a certain speed, slow down and make sure you keep your vehicle speed under the speed of which you experience the instability.
- Do not make jerky, abrupt or sharp turns.

 CAUTION

■ **To avoid accident or injury**

- Do not apply the brakes suddenly as you may skid, resulting in jackknifing and loss of vehicle control. This is especially true on wet or slippery surfaces.
- Do not exceed the trailer hitch assembly weight, gross vehicle weight, gross axle weight and trailer tongue weight capacities.
- Do not use cruise control when towing.
- Slow down and downshift before descending steep or long downhill grades. Do not make sudden downshifts while descending steep or long downhill grades.
- Vehicle-trailer instability is more likely on steep long downhills. Before descending steep or long downhill grades, slow down and downshift. Do not make sudden downshifts when descending steep or long downhill grades. Avoid holding the brake pedal down too long or applying the brakes too frequently. This could cause the brakes to overheat and result in reduced braking efficiency.
- Do not tow a trailer when the temporary spare tire is installed on your vehicle.

■ **Hitch**

Trailer hitch assemblies have different weight capacities established by the hitch manufacturer. Even though the vehicle may be physically capable of towing a higher weight, the operator must determine the maximum weight rating of the particular hitch assembly and never exceed the maximum weight rating specified for the trailer-hitch. Exceeding the maximum weight rating set by the trailer-hitch manufacturer can cause an accident resulting in death or serious personal injuries.

■ **When towing a trailer**

Toyota recommends trailers with brakes that conform to any applicable federal and state/provincial regulations.

- If the gross trailer weight exceeds unbraked TWR, trailer brakes are required. Toyota recommends trailers with brakes that conform to all applicable federal and state/provincial regulations.
- Never tap into your vehicle's hydraulic system, as this will lower the vehicle's braking effectiveness.

 **CAUTION****■ When towing a trailer**

- Never tow a trailer without using a safety chain securely attached to both the trailer and the vehicle. If damage occurs to the coupling unit or hitch ball, there is danger of the trailer wandering into another lane.

 **NOTICE****■ When installing a trailer hitch**

Use only the position recommended by your Toyota dealer. Do not install the trailer hitch on the bumper; this may cause body damage.

■ Do not directly splice trailer lights

Do not directly splice trailer lights. Directly splicing trailer lights may damage your vehicle's electrical system and cause a malfunction.

2-5. Driving information

Dinghy towing

Your vehicle is not designed to be dinghy towed (with 4 wheels on the ground) behind a motor home.

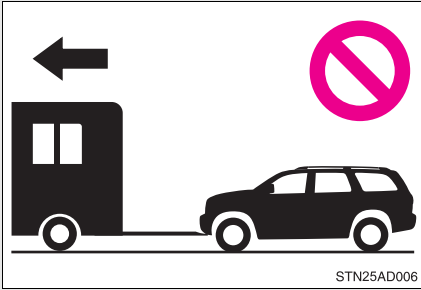

NOTICE

■ To avoid serious damage to your vehicle

Do not tow your vehicle with four wheels on the ground.

3-1. Using the air conditioning system and defogger

Front air conditioning system 294

Rear air conditioning system 303

Rear window and outside rear view mirror defoggers 307

Windshield wiper de-icer 309

3-2. Using the multimedia system

Multimedia system types 310

USB port/AUX port 311

Using the AUX port 312

3-3. Using the interior lights

Interior lights list 313

- Personal/interior light main switch 314
- Personal/interior lights ... 315
- Interior light 316

Interior features

3

3-4. Using the storage features

List of storage features	317
• Glove boxes	318
• Coin holder	319
• Front console box	320
• Card holder	323
• Map holder	324
• Pen holder	326
• Tissue pocket.....	327
• Rear console box.....	328
• Overhead console.....	331
• Cup holders	333
• Bottle holders.....	337
• Auxiliary boxes.....	338

3-5. Using the other interior features

Sun visors	340
Vanity mirrors.....	341
Clock.....	342
Outside temperature display.....	343
Portable ashtray.....	345
Cigarette lighter.....	346
Conversation mirror	347
Power outlets	348
Seat heaters.....	354
Seat heaters and ventilators	357
Armrests.....	359
Rear side sunshades	360
Assist grips.....	362
Floor mat.....	363
Luggage compartment features.....	365
Garage door opener.....	370
Compass.....	376

3-1. Using the air conditioning system and defogger

Front air conditioning system

Airflow and outlets are automatically adjusted according to the temperature setting.

► Control panel

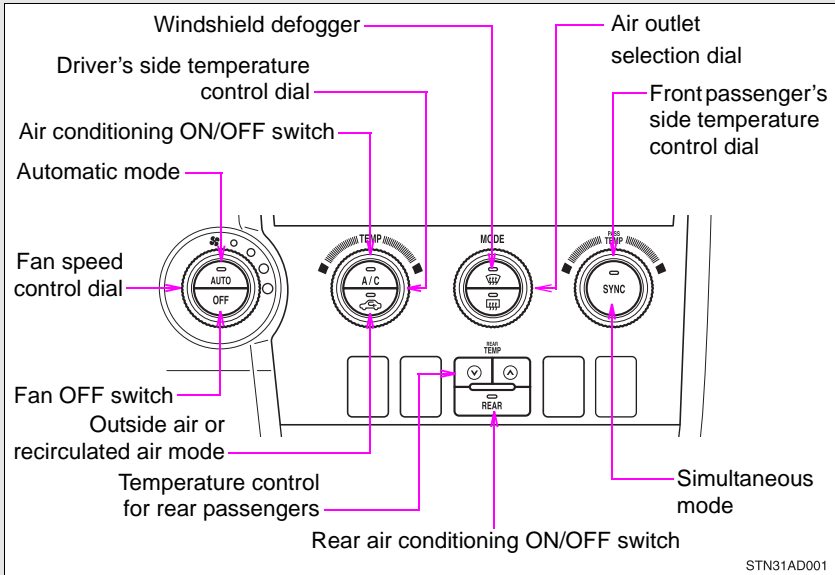

► Display

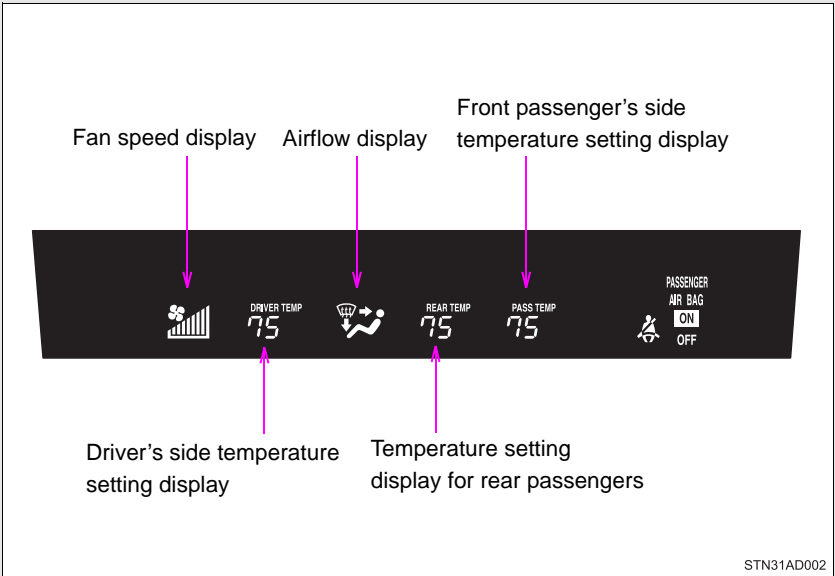

Using the automatic mode

STEP 1 Press .

The air conditioning system will begin to operate. Air outlets and fan speed are automatically adjusted according to the temperature setting.

STEP 2 Turn the temperature control dial clockwise (warm) or counterclockwise (cool).

The temperature for the driver and passenger seat can be set separately.

■ Automatic mode indicator

If the fan speed setting or air flow modes are operated, the automatic mode indicator goes off. However, automatic mode for functions other than that operated are maintained.

Adjusting the settings

■ Adjusting the temperature setting

Turn the temperature control dial clockwise (warm) or counter-clockwise (cool).

The air conditioning system switches between individual and simultaneous modes each time  is pressed.

- Simultaneous mode (the indicator on  is on)

The driver's side temperature control dial can be used to adjust the temperature for all seats.

- Individual mode (the indicator on  is off)

The temperature for the driver's, front passenger's and rear seats (→P. 303) can be adjusted separately. Operate the passenger's side or rear temperature controls to enter individual mode.

■ Adjusting the fan speed

Turn the fan speed control dial clockwise (increase) or counter-clockwise (decrease).

The fan speed is shown on the display. (7 levels)

Press  to turn the fan off.

■ Changing the air outlets

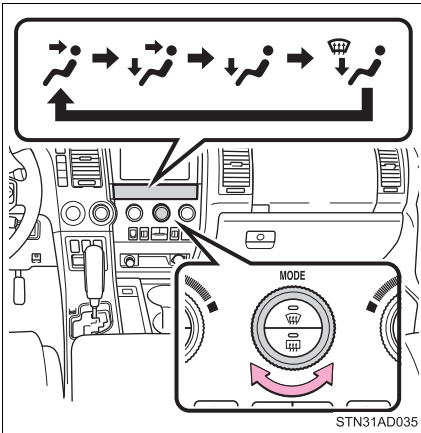

Turn the air outlet selection dial.

The air outlets switch each time either side of air outlet selection dial is turned.

Air flow as shown according to the mode selected.

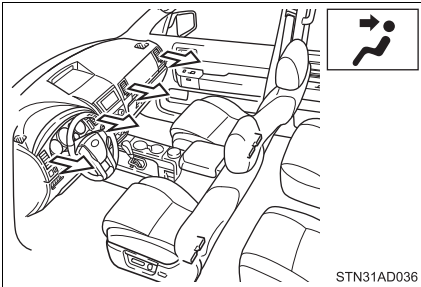

When the dial is set to , air flows to the upper body.

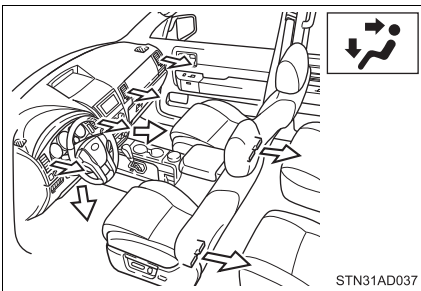

When the dial is set to , air flows to the upper body and feet.

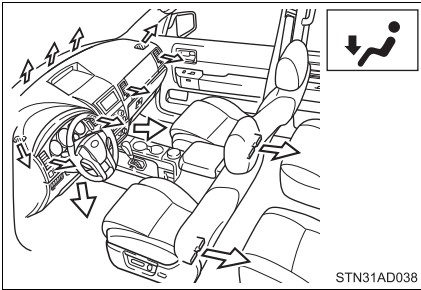

When the dial is set to , air flows to the feet.

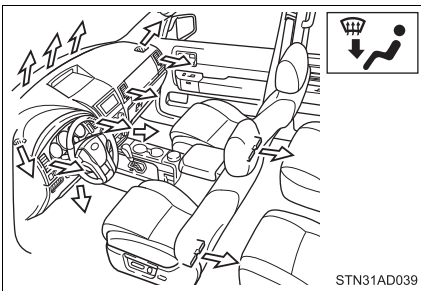



When the dial is set to , air flows to the feet and the windshield defogger operates.

Recirculated air mode will automatically switch to outside air mode.

■ Switching between outside air and recirculated air modes

Press .

The mode switches between  (outside air mode) and  (recirculated air mode) each time the switch is pressed.

Changing the rear seat settings

■ Adjusting the temperature setting

Press  to increase the temperature and  to decrease it.

The air conditioning system switches between individual and simultaneous modes each time  is pressed.

Defogging the windshield

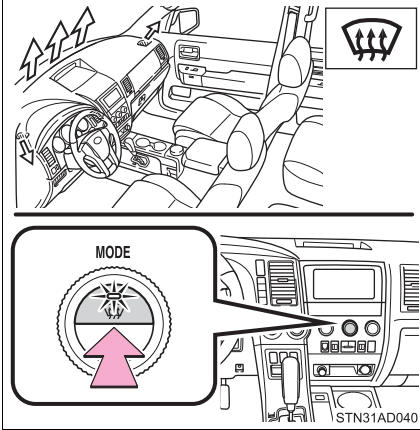

Press .

The indicator comes on.

The air conditioning system control operates automatically.

Recirculated air mode will automatically switch to outside air mode.

Adjusting the position and opening and closing the air outlets

► Driver side outlets

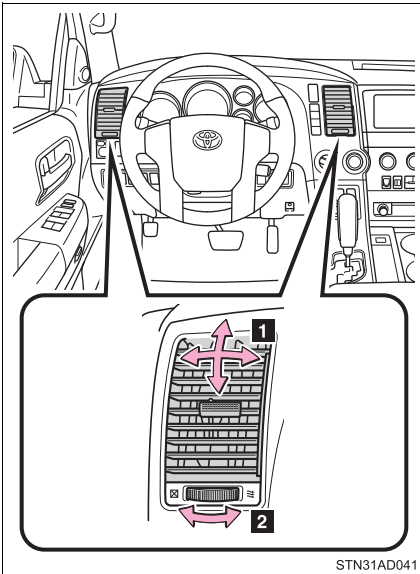

1 Direct air flow to the left or right, up or down.

2 Turn the knob to open or close the vent.

► Passenger side outlets

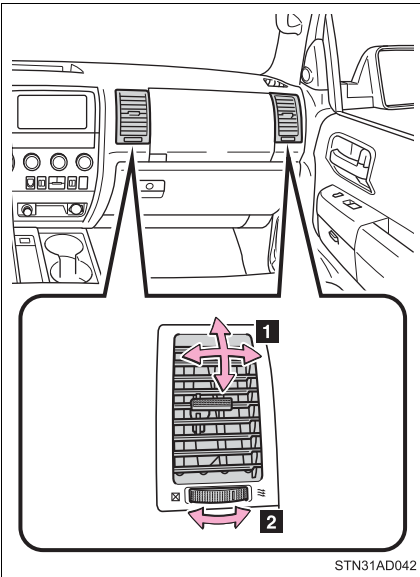

- 1 Direct air flow to the left or right, up or down.
- 2 Turn the knob to open or close the vent.

■ Using the automatic mode

Fan speed is adjusted automatically in accordance with the temperature setting and ambient conditions. As a result, the following may occur.

- Immediately after the switch is pressed, the fan may stop for a while until warm or cool air is ready to flow.
- Cool air may flow to the area around the upper body when the heater is on.

■ Using the system in recirculated air mode

The windows will fog up more easily if the recirculated air mode is used for an extended period.

■ Switching between outside air and recirculated air modes

Recirculated air mode or outside air mode may be automatically switched in accordance with the temperature setting and the inside temperature.

■ When the outside temperature exceeds 75°F (24°C) and the air conditioning system is on

- In order to reduce the air conditioning power consumption, the air conditioning system may switch to recirculated air mode automatically. This may also reduce fuel consumption.
- Recirculated air mode is selected as a default mode when the engine switch is in the ON position.
- It is possible to switch to outside air mode at any time by pressing



■ Window defogger feature

Recirculated air mode may automatically switch to outside air mode in situations where the windows need to be defogged.

■ When outside temperature approaches 32°F (0°C)

The air conditioning system may not operate even when  is pressed.

■ When the indicator on flashes

Press  and turn off the air conditioning system before turning it on once more. There may be a problem in the air conditioning system if the indicator continues to flash. Turn the air conditioning system off and have it inspected by your Toyota dealer.

■ Ventilation and air conditioning odors

- To let fresh air in, set the air conditioning system to the outside air mode.
- During use, various odors from inside and outside the vehicle may enter into and accumulate in the air conditioning system. This may then cause odor to be emitted from the vents.
- To reduce potential odors from occurring:
 - It is recommended that the air conditioning system be set to outside air mode prior to turning the vehicle off.
 - The start timing of the blower may be delayed for a short period of time immediately after the air conditioning system is started in automatic mode.

 CAUTION

■ **To prevent the windshield from fogging up**

Do not use  during cool air operation in extremely humid weather. The difference between the temperature of the outside air and that of the windshield can cause the outer surface of the windshield to fog up, blocking your vision.

 NOTICE

■ **To prevent battery discharge**

Do not leave the air conditioning system on longer than necessary when the engine is stopped.

3-1. Using the air conditioning system and defogger

Rear air conditioning system

Airflow and outlets are automatically adjusted according to the temperature setting.

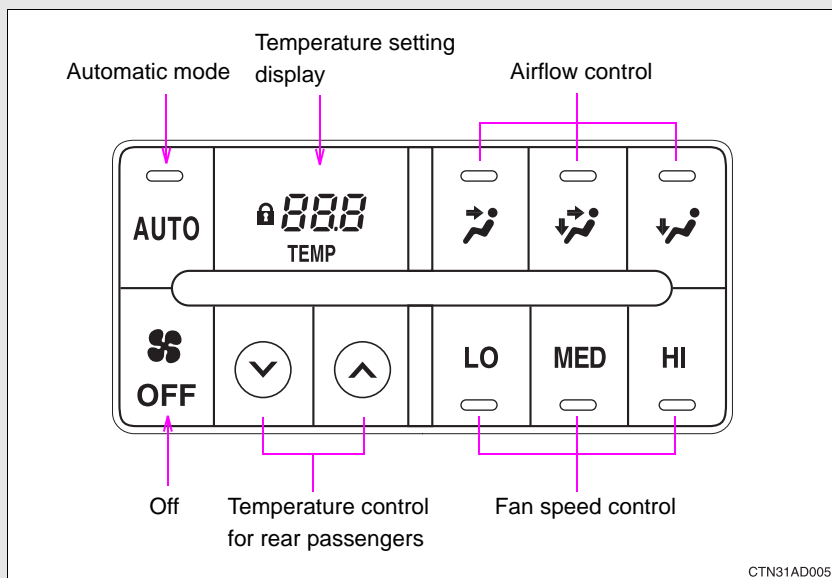

■ Button lock function

During Simultaneous mode (the indicator on  is on), the rear air conditioning system buttons will be automatically locked. (→P. 296)

 appears on the display when the buttons are locked.

To unlock the buttons, choose the Individual mode (the indicator on

 is off). (→P. 296)

Using the automatic mode

STEP 1 Press



The indicator comes on.

The air conditioning system will operate, and air outlets and fan speed will be set automatically.

STEP 2 Press



to increase the temperature and



to

decrease it.

Adjusting the settings

■ Adjusting the temperature setting

Press



to increase the temperature and



to decrease it.

■ Changing the air outlets

Press the desired



or



.

Air flows as shown below according to the mode selected.

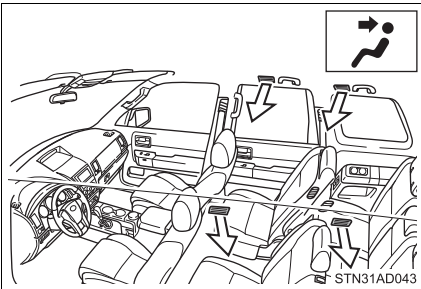

When



is pressed, air

flows to the upper body.

The indicator comes on.

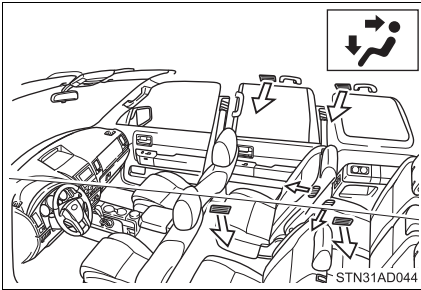

When  is pressed, air flows to the upper body and feet.

The indicator comes on.

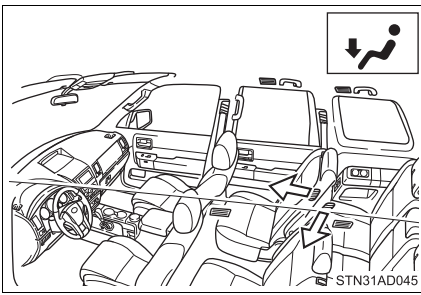

When  is pressed, air flows to the feet.

The indicator comes on.

■ Adjusting the fan speed

Press the  (decrease ↔ increase) button.

The indicator comes on.

Press  to turn the fan off.

Adjusting the position and opening and closing the air outlets

Roof side outlets

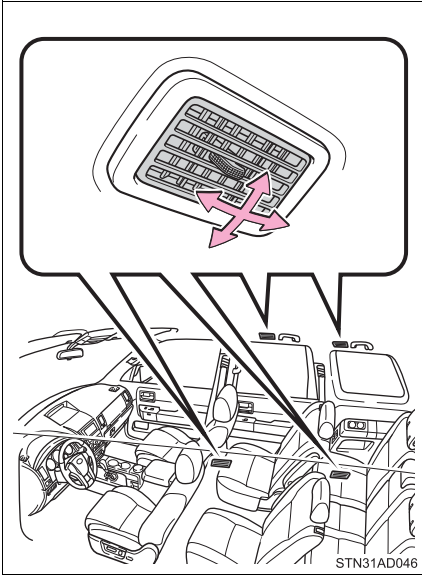

Direct air flow to the left or right, up or down.

NOTICE

To prevent battery discharge

Do not leave the air conditioning system on longer than necessary when the engine is stopped.

3-1. Using the air conditioning system and defogger Rear window and outside rear view mirror defoggers*

These features are used to defog the rear window, and to remove raindrops, dew and frost from the outside rear view mirrors.

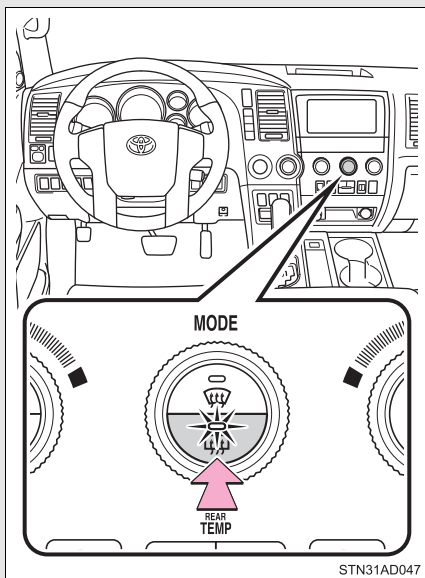

On/off

Press the button to turn on the rear window defogger. The indicator light will come on. The defogger will automatically turn off after 15 to 240 minutes. The operation time changes according to the ambient temperature and vehicle speed. Pressing the button again also turns the defogger off.

■ **The rear window and outside rear view mirror defoggers can be operated when**

- The engine switch is in the ON position.
- The back window is completely closed.

■ **Outside rear view mirror defoggers (vehicles with outside rear view mirror defoggers)**

Turning the rear window defogger on will turn the outside rear view mirror defoggers on.

*: If equipped

 CAUTION

■ **When the outside rear view mirror defoggers are on (vehicles with outside rear view mirror defoggers)**

Do not touch the rear view mirror surfaces, as they can become very hot and burn you.

3-1. Using the air conditioning system and defogger Windshield wiper de-icer*

This feature is used to prevent ice from building up on the windshield and wiper blades.

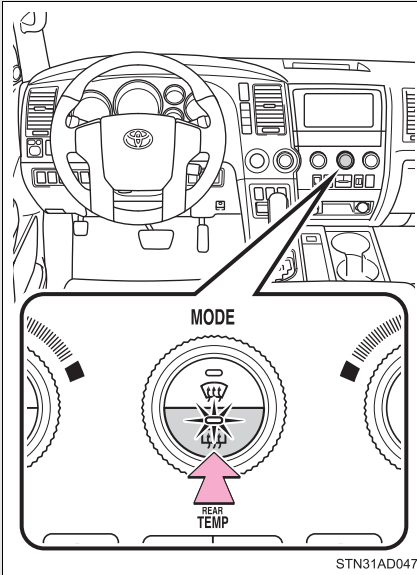

On/off

Press the button to turn on the windshield wiper de-icer. The indicator light will come on. The windshield wiper de-icer will automatically turn off after 15 to 240 minutes. The operation time changes according to the ambient temperature and vehicle speed. Pressing the button again also turns the defogger off.

■ The de-icer can be operated when

- The engine switch is in the ON position.
- The back window is completely closed.

▲ CAUTION

■ When the windshield wiper de-icer is on

Do not touch the glass at the lower part of the windshield or to the side of the front pillars as the surfaces can become very hot and burn you.

*: If equipped

3-2. Using the multimedia system Multimedia system types*

► Entune Audio Plus

Refer to the “NAVIGATION SYSTEM OWNER’S MANUAL”.

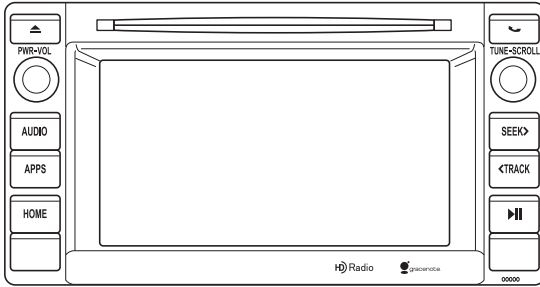

STS32AD005

► Entune Premium Audio

Refer to the “NAVIGATION SYSTEM OWNER’S MANUAL”.

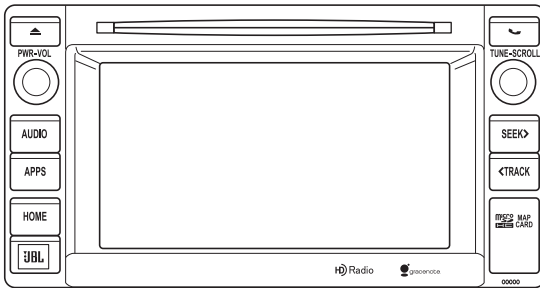

STS32AD006

*: If equipped

3-2. Using the multimedia system USB port/AUX port

Connect an iPod, USB memory device or portable audio player to the USB port/AUX port as indicated below. Select “iPod”, “USB” or “AUX” on the “Select Audio Source” screen and the device can be operated via multimedia system.

Connecting using the USB port/AUX port

■ iPod

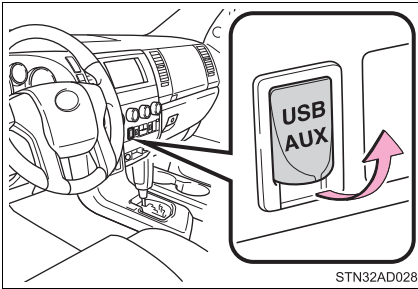

Open the cover and connect an iPod using an iPod cable.

Turn on the power of the iPod if it is not turned on.

■ USB memory

Open the cover and connect the USB memory device.

Turn on the power of the USB memory device if it is not turned on.

■ Portable audio player

Open the cover and connect the portable audio player.

Turn on the power of the portable audio player if it is not turned on.

⚠ CAUTION

■ While driving

Do not connect a device or operate the device controls.

Using the AUX port

To use the AUX port, connect a portable player, then select “AUX” on the “Select Audio Source” screen.

Connecting a portable audio player

→P. 311

■ Operating portable audio players connected to the multimedia system

The volume can be adjusted using the vehicle’s audio controls. All other adjustments must be made on the portable audio player itself.

■ When using a portable audio player connected to the power outlet

Noise may occur during playback. Use the power source of the portable audio player.



CAUTION

■ While driving

Do not connect a portable audio player or operate the device controls.

Interior lights list

Your Toyota is equipped with an illuminated entry system to assist in entering the vehicle. Due to the function of the system, the lights shown in the following illustration automatically turn on/off according to whether the doors are locked/unlocked, whether the doors are opened/closed, and the engine switch position.

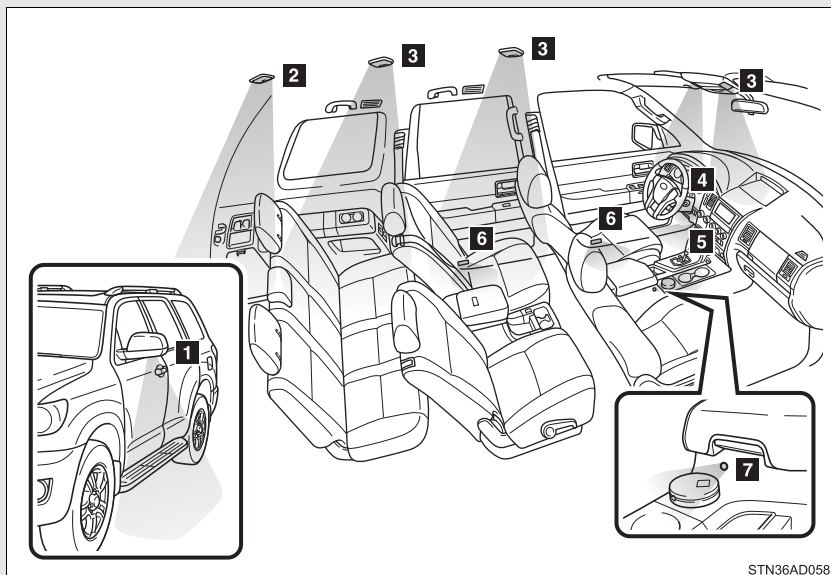

- 1** Outer foot lights (if equipped)
- 2** Interior light (→P. 316)
- 3** Personal/interior lights (→P. 315)
- 4** Engine switch light
- 5** Foot well lighting
- 6** Door courtesy lights
- 7** Ashtray lighting

■ To prevent the battery from being discharged

If the lights remain on when the door is not fully closed and the personal/interior light main switch is in door position, the lights will go off automatically after 20 minutes.

■ Customization

- That can be configured at Toyota dealer (vehicles without multi-information display)

Settings (e.g. The time elapsed before lights turn off) can be changed. (Customizable features →P. 539)

- It is possible to change the settings (vehicles with multi-information display) (Feature customization →P. 181)

Personal/interior light main switch

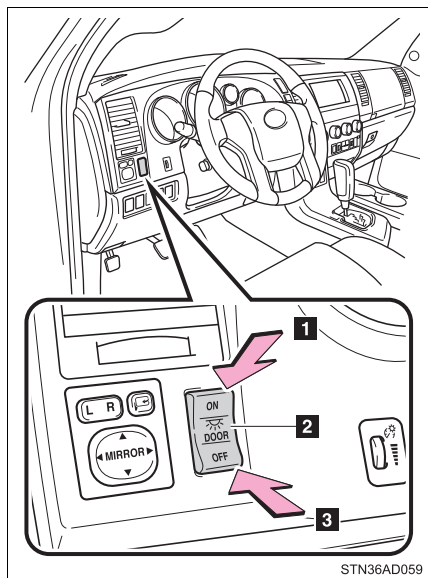

1 ON

The personal/interior lights cannot be individually turned off.

2 DOOR position

The personal/interior lights come on when a door is opened. They turn off when the doors are closed.

3 OFF

The personal/interior lights and interior light can be individually turned on or off.

Personal/interior lights

■ **Front**

▶ **Type A**

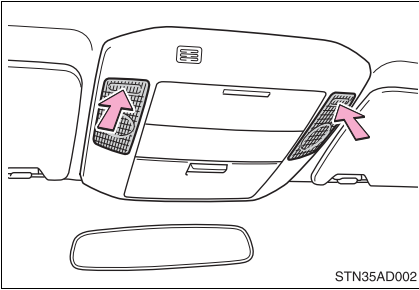

On/off

▶ **Type B**

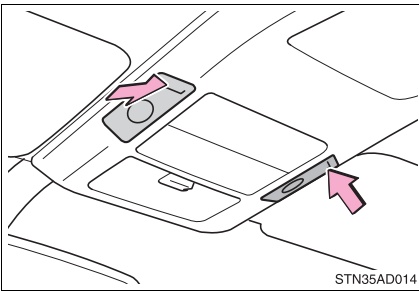

On/off

■ **Center**

▶ **Type A**

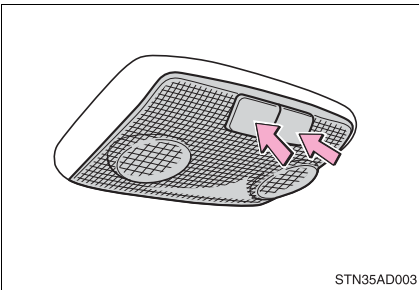

On/off

► Type B

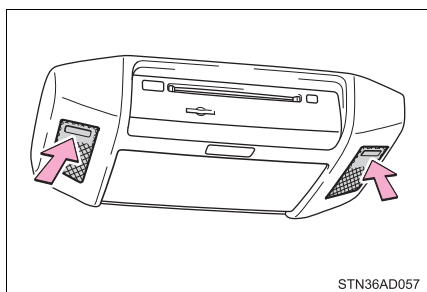

On/off

■ Rear

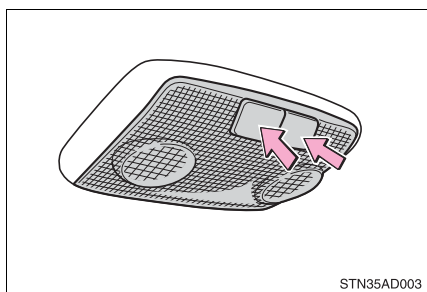

On/off

Interior light

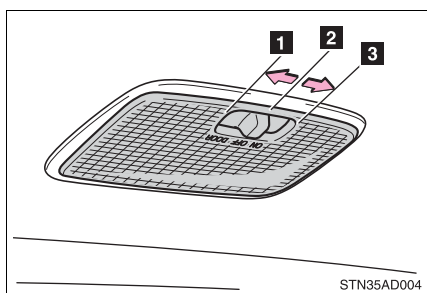

1 DOOR position

The interior light comes on when a back door is opened. It turns off when the door is closed.

2 OFF

3 ON

3-4. Using the storage features

List of storage features

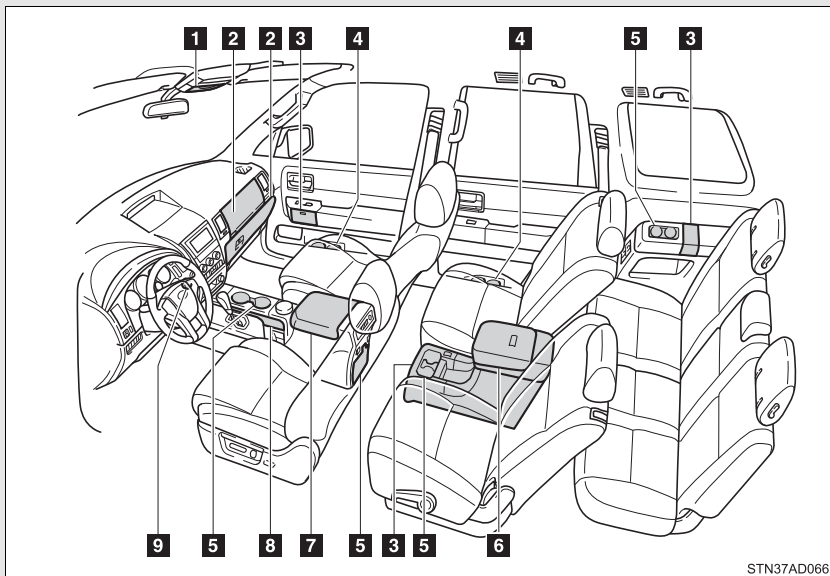

- 1** Overhead console
- 2** Glove boxes
- 3** Auxiliary boxes
- 4** Bottle holders
- 5** Cup holders
- 6** Rear console box (if equipped)
Cup holder (if equipped)
- 7** Front console box
 - Card holder
 - Map holder
 - Pen holder
 - Tissue pocket
- 8** Map holder
- 9** Coin holder (if equipped)

⚠ CAUTION**■ Items that should not be left in the storage spaces**

Do not leave glasses, lighters or spray cans in the storage spaces, as this may result in the following when cabin temperature becomes high:

- Glasses may be deformed by heat or cracked if they come into contact with other stored items.
- Lighters or spray cans may explode. If they come into contact with other stored items, the lighter may catch fire or the spray can may release gas, causing a fire hazard.

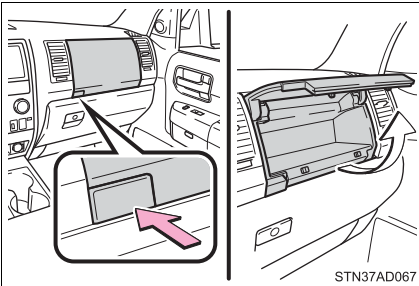
Glove boxes**▶ Upper glove box**

Push the button.

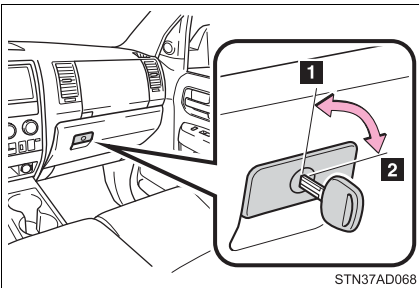
▶ Lower glove box

- 1** Unlock with the master key
- 2** Lock with the master key

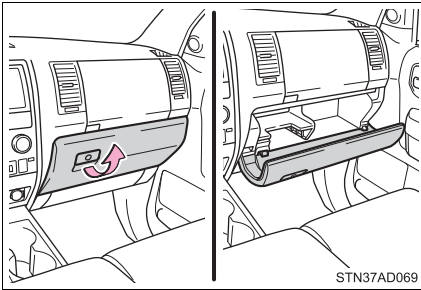

Pull the lever up.

■ Glove box light

The glove box light turns on when the tail lights are on.

⚠ CAUTION

■ Caution while driving

Keep the glove box closed. In the event of sudden braking or sudden swerving, an accident may occur due to an occupant being struck by the open glove box or the items stored inside.

■ Coin holder (if equipped)

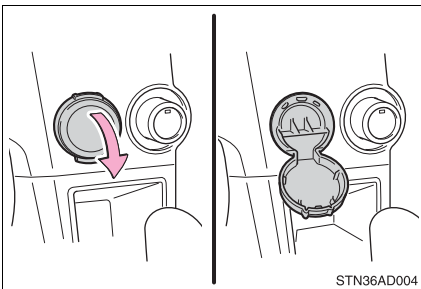

Open the lid.

! CAUTION

Caution while driving

Keep the coin holder closed.
Injuries may result in the event of an accident or sudden braking.

Front console box

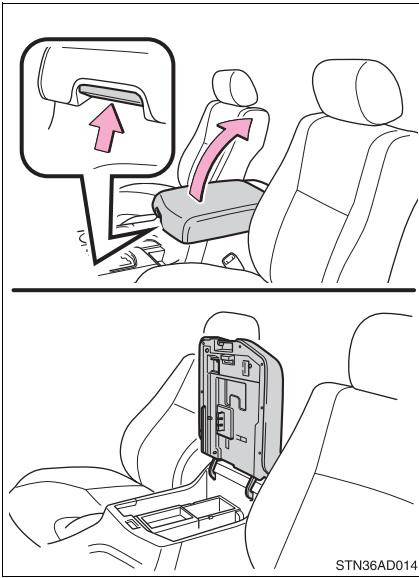

Pull the knob up and lift the lid.

■ When using the front console box lid as an armrest

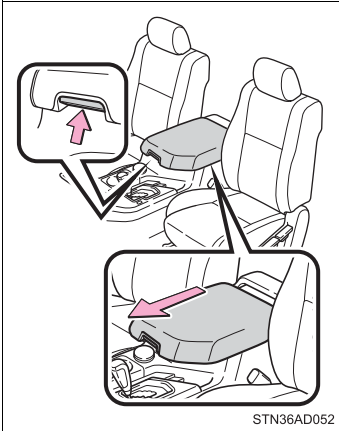

Pull the knob up and slide the lid forward.

If necessary, the console box lid can slide forward. Pull the lid forward by grasping the front of the lid.

When the lid is forward, it cannot be lifted.

■ Tray in the front console box

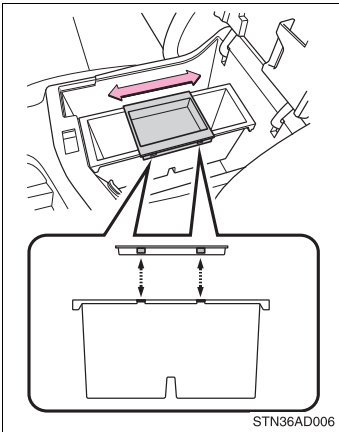

The tray slides forward or backward. The tray can be removed.

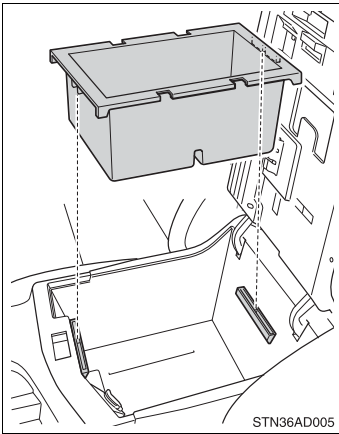

The box can be removed. Hanging file folders can be hung on the rails when the box is removed.

⚠ CAUTION

■ Caution while driving

Keep the console box closed.

Injuries may result in the event of an accident or sudden braking.

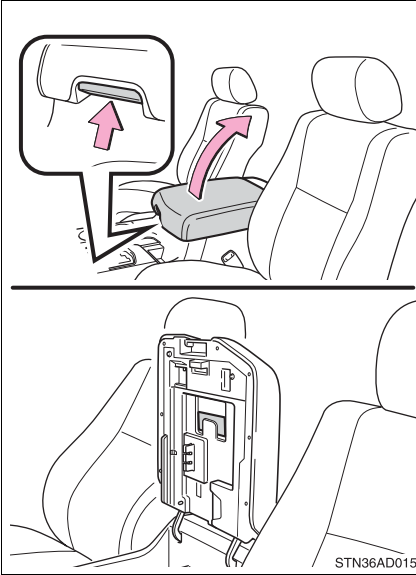
Card holder

Pull the knob up and lift the lid.

⚠ CAUTION

■ Caution while driving

Keep the console box closed.
Injuries may result in the event of an accident or sudden braking.

Map holder

► Center console

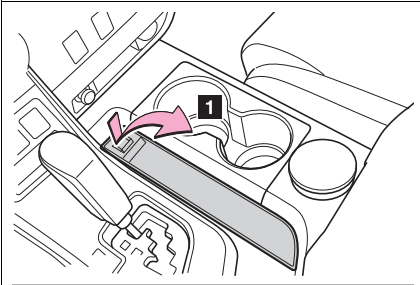

1 Push the tab down to release the lock. Remove the lid.

2 Stow the lid.

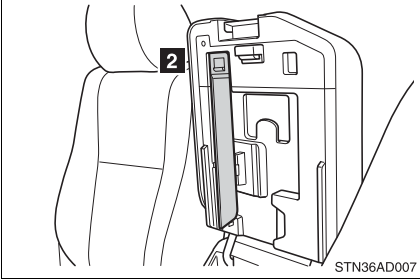

STN36AD007

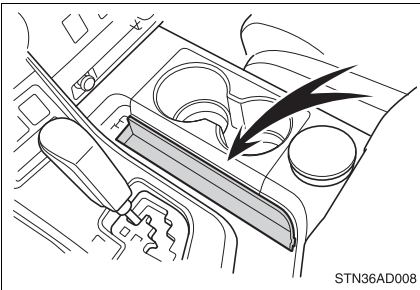

STN36AD008

! CAUTION

■ Caution while driving

Keep the console box closed.

Injuries may result in the event of an accident or sudden braking.

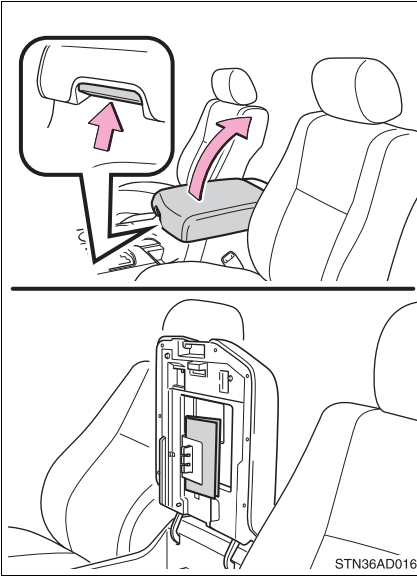
► Front console box

Pull the knob up and lift the lid.

⚠ CAUTION**■ Caution while driving**

Keep the console box closed.
Injuries may result in the event of an accident or sudden braking.

Pen holder

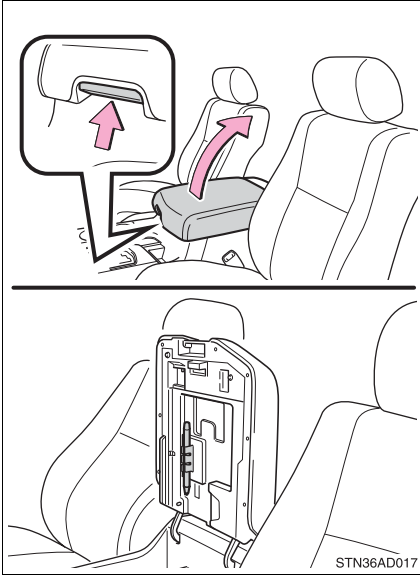

Pull the knob up and lift the lid.

⚠ CAUTION

■ Caution while driving

Keep the console box closed.
Injuries may result in the event of an accident or sudden braking.

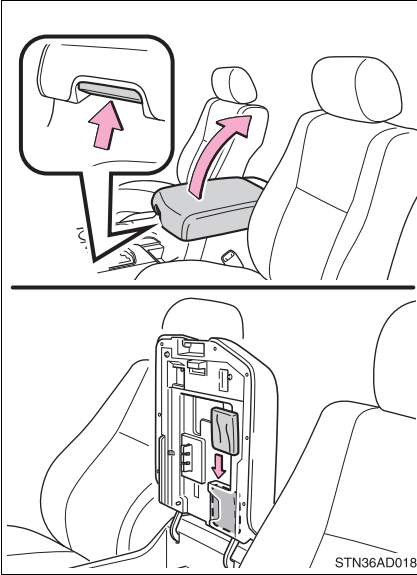
Tissue pocket

Pull the knob up and lift the lid.

⚠ CAUTION**■ Caution while driving**

Keep the console box closed.
Injuries may result in the event of an accident or sudden braking.

Rear console box (if equipped)

► Upper box

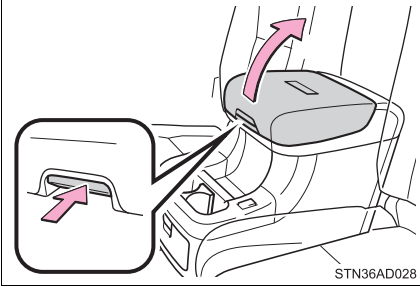

Push the knob and lift the lid.

► Lower box

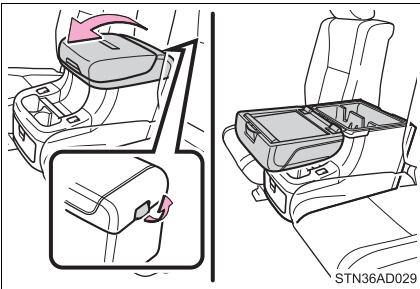

Pull the knob up and lift the upper box.

- The separator can be used at either of two positions shown in the illustration

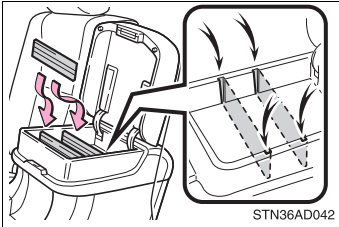

Change the separator position.

- The separator can be stowed

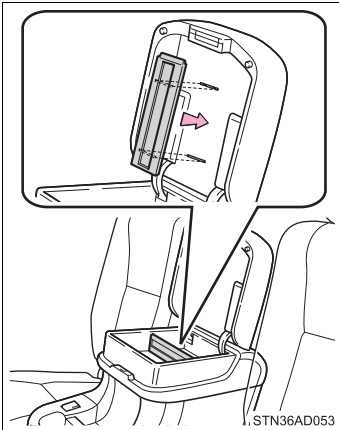

Stow the separator to the lid.

- Back side tray

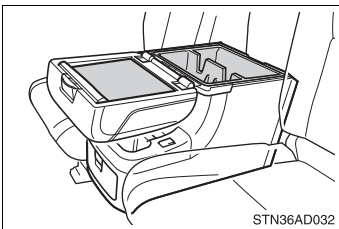

Open the upper box to use the back side tray.

■ **The inside tray can be removed**

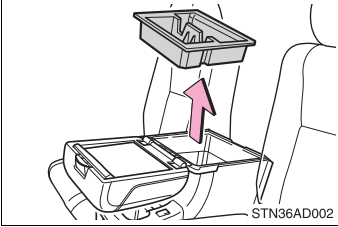

Pull the tray up.

■ **When closing the rear console box lid**



Close the rear console box by lifting the grip on the inside of the upper box.

⚠ CAUTION**■ Caution while driving**

Keep the console box closed.

Injuries may result in the event of an accident or sudden braking.

■ When opening/closing the lower box

Be careful not to get your hands or feet caught between the lower box and the upper box.

Failure to do so may result in serious injury.

■ When opening the lower box

Make sure that the upper box is locked. Items stored inside may fall out and cause injury.

Overhead console

The overhead console is useful for temporarily storing sunglasses and similar small items.

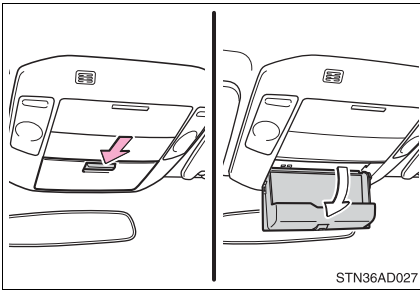
► Type A

Push the knob forward to open the console.

► Type B

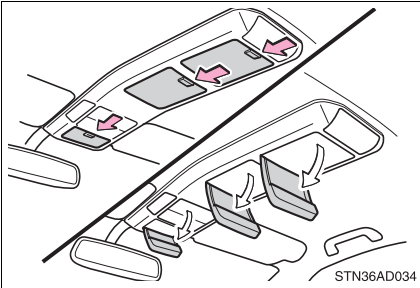

Push the knob forward to open the console.

! CAUTION

■ Caution while driving

Do not leave the overhead console open while driving. Items stored in it may fall out and cause injury.

Cup holders

► Front

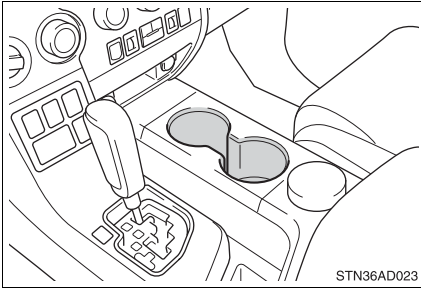

► Front console box

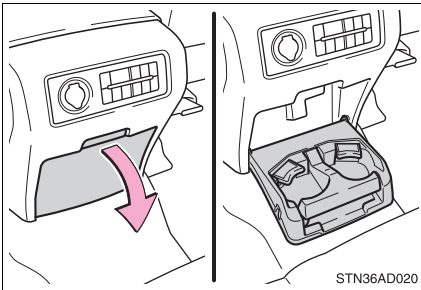

Pull the lid down.

► Rear

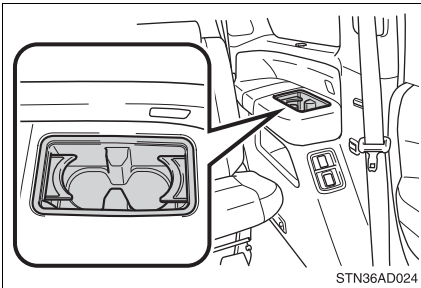

► Rear console box (if equipped)

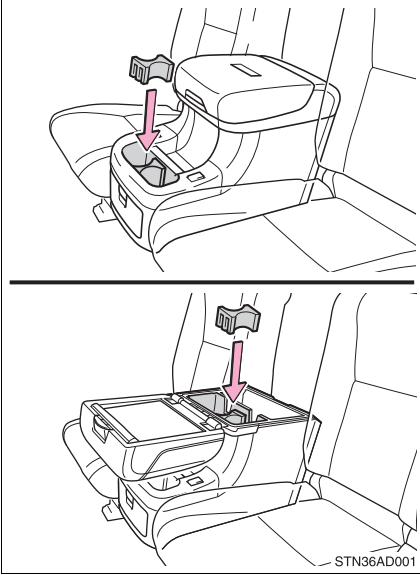

Attach the separator when using either console box as a cup holder.

Both cup holders cannot be used at the same time.

■ Removing the cup holder (front)

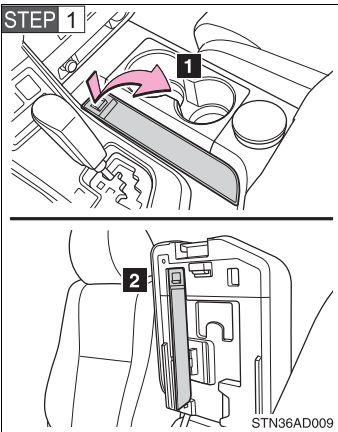

1 Push the tab down to release the lock. Remove the lid.

2 Stow the lid.

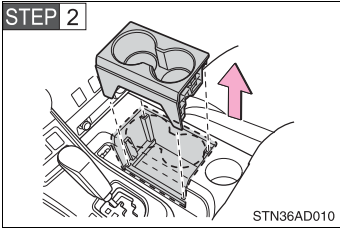

Pull the cup holder up.

■ **Removing the separator (rear console box)**

► Inside

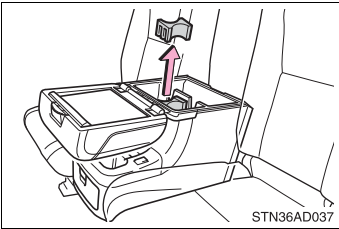

Pull the separator up.

► Outside

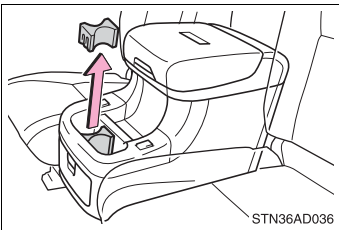

Pull the separator up.

■ **The position of the separator can be changed (rear console box)**

▶ **Inside**

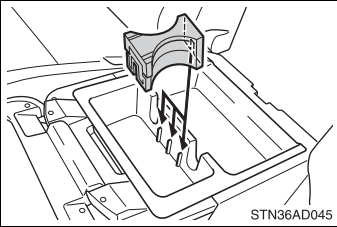

Change the separator position.

▶ **Outside**

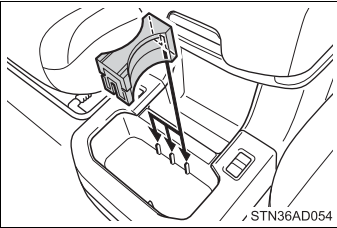

Change the separator position.

■ **The separator can be adjusted (rear console box)**

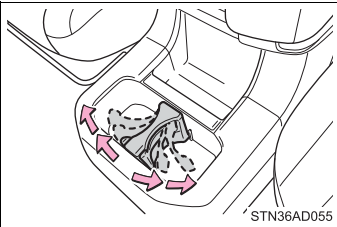

Adjust the separator.

⚠ CAUTION**■ Items unsuitable for the cup holder**

Do not place anything other than cups or aluminum cans in the cup holders. Other items may be thrown out of the holders in the event of an accident or sudden braking and cause injury. If possible, cover hot drinks to prevent burns.

■ When not in use

Front console box and rear console box (inside) cup holder: Keep the cup holders closed.

Injuries may result in the event of an accident or sudden braking.

⚠ NOTICE**■ Before sliding the second center seat to the most forward position (vehicles with bench type second seat)**

Ensure that the cup holder on the front console box is closed.

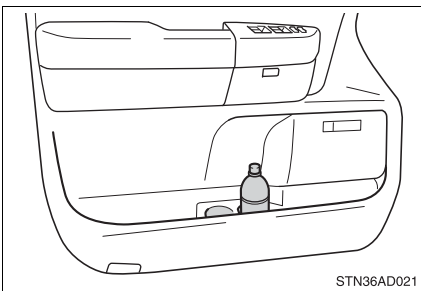
Bottle holders**► Front**

STN36AD021

► Rear

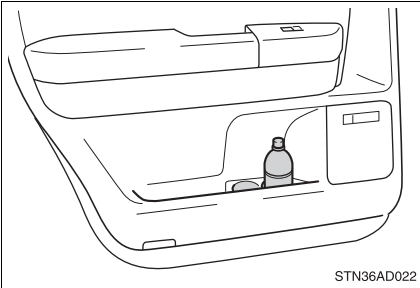

 NOTICE

■ **Items that should not be stowed in the bottle holders**

Put the cap on before stowing a bottle. Do not place open bottles in the bottle holders, or glasses and paper cups containing liquid. The contents may spill and glasses may break.

Auxiliary boxes

► Front

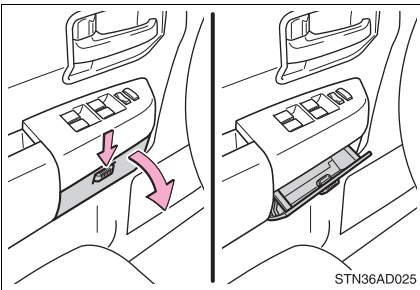

Press the knob then pull the lid down.

▶ Rear

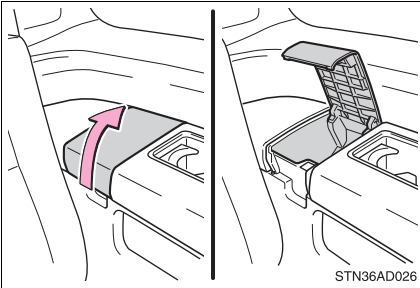

Pull the lid up.

▶ Rear console box (if equipped)

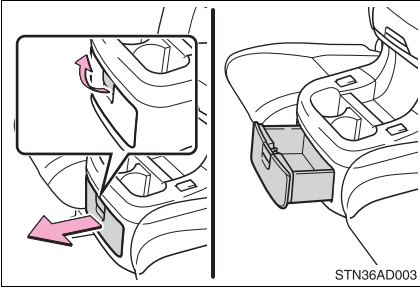

Pull the lever up to release the lock. Pull the handle.

⚠ CAUTION

■ Caution while driving

Keep the auxiliary boxes closed.
Injuries may result in the event of an accident or sudden braking.

Sun visors

■ Main visor

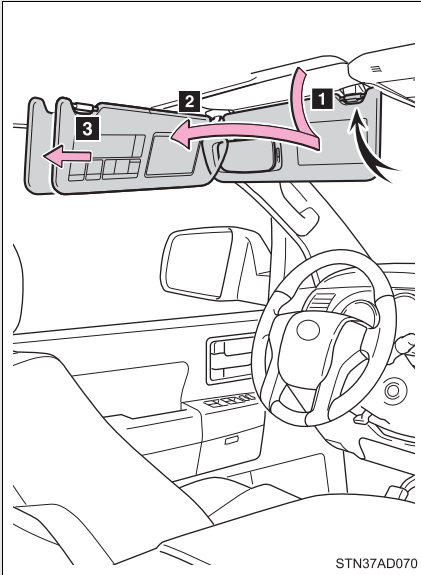

1 Forward position:

Flip down.

2 Side position:

Flip down, unhook, and swing to the side.

3 Side extender:

Place in side position then slide backwards.

■ Sub visor (if equipped)

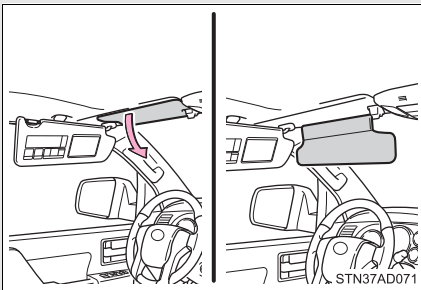

Flip down.

Vanity mirrors

► Vehicles without vanity light

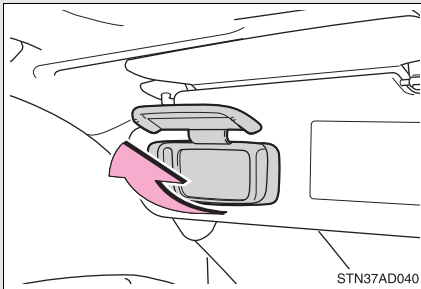

Open the cover.

► Vehicles with vanity light

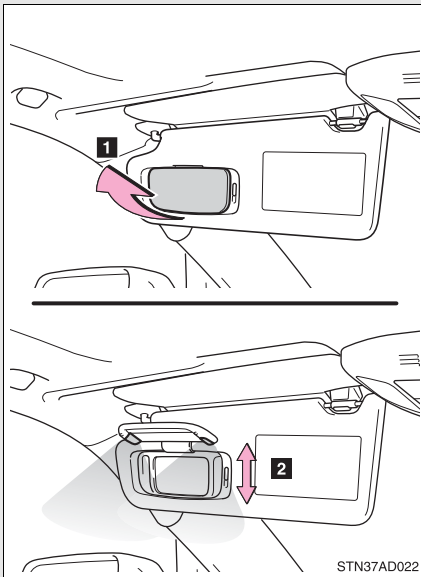

1 Open the cover.

The light turns on when the cover is opened.

2 Adjust the brightness of the light.

3-5. Using the other interior features

Clock

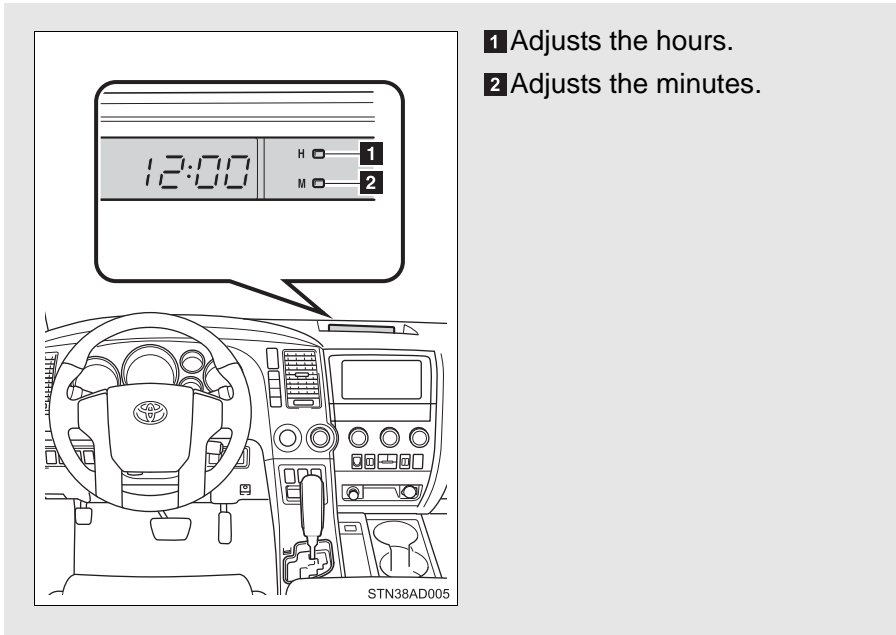

■ For quicker adjustment of the clock

Hold down the M or H button continuously. This allows faster advancement of the minutes and hours.

■ The clock is displayed when

The engine switch is in the ACC or ON position.

■ When disconnecting and reconnecting battery terminals

The time display will automatically be set to 1:00.

3-5. Using the other interior features

Outside temperature display

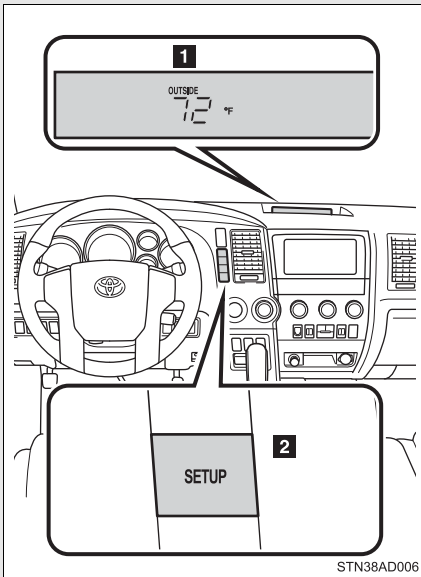

- 1 Displays the outside air temperature.

The temperature range that can be displayed is from -40°F (-40°C) to 122°F (50°C).

- 2 Switches the outside air temperature display between °C (Celsius) and °F (Fahrenheit). (if equipped)

Vehicles without multi-information display:

Push the SETUP button until the desired unit of measurement is displayed.

Vehicles with multi-information display:

With the customized unit-change operation for the multi-information display, the unit of measurement can be changed. (→P. 184)

■ **When --°C or --°F is displayed**

The system may be malfunctioning. Take your vehicle to your Toyota dealer.

■ **The outside air temperature is displayed when**

The engine switch is in the ON position.

■ **When disconnecting and reconnecting battery terminals**

The display will automatically be set to the initial mode.

■ **Display**

In the following situations, the correct outside temperature may not be displayed, or the display may take longer than normal to change.

- When stopped, or driving at low speeds (less than 16 mph [25 km/h])
- When the outside temperature has changed suddenly (at the entrance/exit of a garage, tunnel, etc.)

Portable ashtray

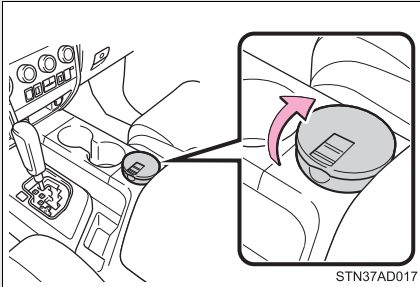

The ashtray can be installed in a cup holder.

■ The ashtray can be removed

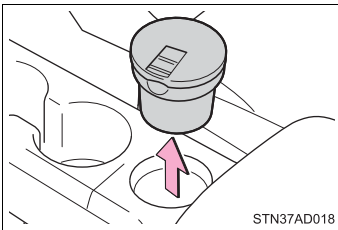

Pull the ashtray up.

⚠ CAUTION

■ When not in use

Keep the ashtray closed.

Injuries may result in the event of sudden braking, sudden swerving or an accident.

■ To prevent fire

- Fully extinguish matches and cigarettes before putting them in the ashtray, and then make sure the ashtray is fully closed.
- Do not place paper or any other type of flammable object in the ashtray.

Cigarette lighter

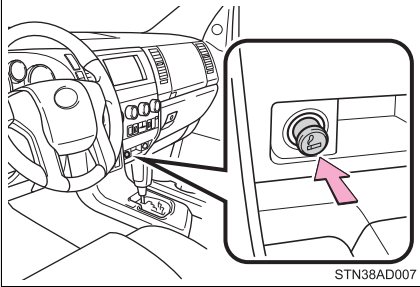

Push the cigarette lighter.

The cigarette lighter will pop up when it is ready for use.

■ **The cigarette lighter can be used when**

The engine switch is in the ACC or ON position.

⚠ CAUTION

■ **To avoid burns or fires**

- Do not touch the metal parts of the cigarette lighter.
- Do not hold the cigarette lighter down. It could overheat and cause a fire.
- Do not insert anything other than the cigarette lighter into the outlet.

3-5. Using the other interior features

Conversation mirror

STEP 1

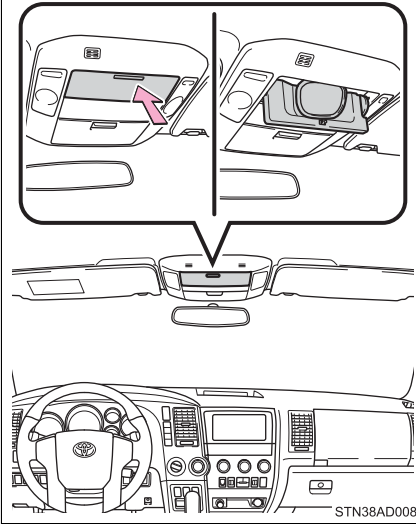

Push the lid.

STEP 2

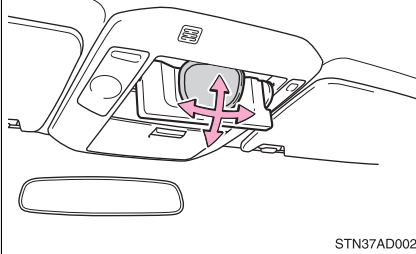

The mirror can be adjusted by pushing the mirror edge.

CAUTION

Caution while driving

Do not adjust the position of the mirror while driving.

Doing so may lead to mishandling of the vehicle and an accident, resulting in death or serious injury.

3-5. Using the other interior features

Power outlets

The power outlet can be used for a following component.

12 V: Accessories that run on less than 10 A.

120 V AC: Accessories that use less than 100 W.

► Instrument panel (12 V)

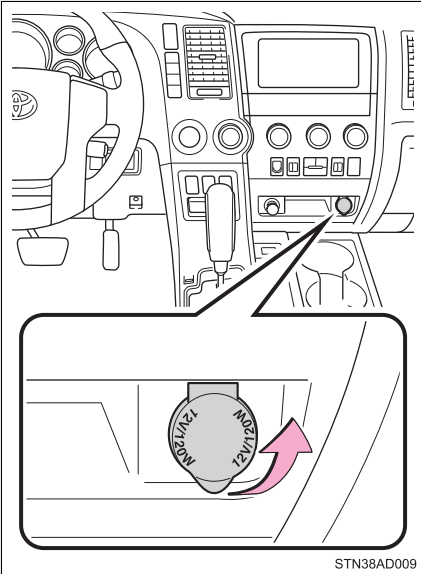

► Inside the front console box (12 V)

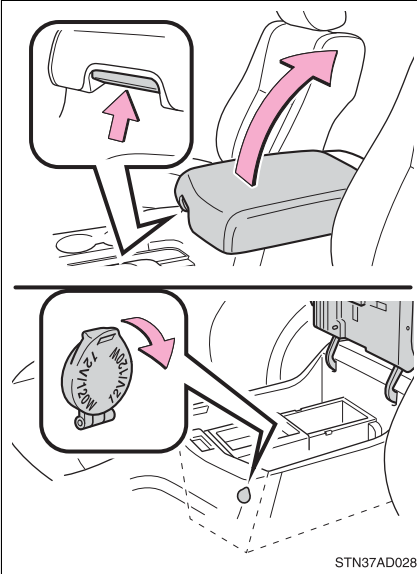

Pull the knob up to release the lock. Lift the lid.

► Back of the front console box (12 V)*1

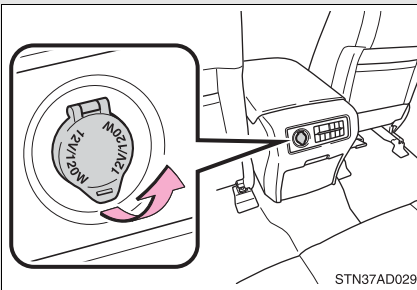

*1: Vehicles without rear seat entertainment system

► Back of the front console box (120 V AC)*²

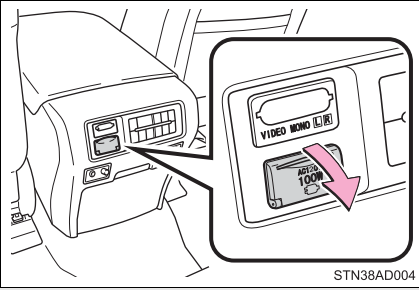

Power outlet socket

► Luggage compartment (12 V)

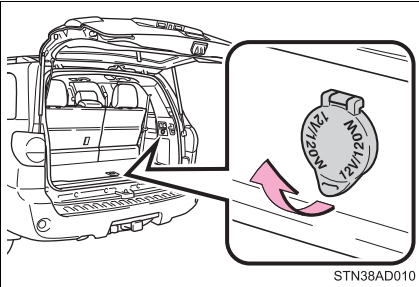

*²: Vehicles with rear seat entertainment system

■ The power outlet can be used when

► 12 V

The engine switch is in the ACC or ON position.

► 120 V AC

The engine switch is in the ON position.

 CAUTION**■ Using a power outlet**

Observe the following precautions to reduce the risk of injury.

- Use of the power outlet when it is wet with drinks or snow may result in electrical shocks and is extremely dangerous. The power outlet must be thoroughly dried before use.
- Do not allow children to use or play with the power outlet.
- Be careful not to get any part of your body caught in the power outlet lid.
- When using electrical appliances, strictly follow any cautions and notices written on their labels and in the manufacturers' instruction manuals.
- Do not modify, disassemble or repair the power outlet or its inverter, in any way. Doing so may result in unexpected malfunctions or accidents, which could cause serious damage or injuries. Contact a Toyota dealer for any necessary repairs.

■ To prevent injuries and accidents, securely fix all electric appliances before use and do not use any appliances that may do any of the following:

- Distract the driver while driving, or hamper safe driving.
- Result in a fire or burn injuries due to the appliance rolling, falling or overheating while driving.
- Emit steam, while the windows of the cabin are closed.

■ To prevent unexpected accidents, such as electric shocks, do not perform any of the following.

- Using the power outlet for electric heaters while sleeping.
- Contaminating the power outlet with liquid substances or mud.
- Handling electrical appliance plugs at the power outlet with wet hands or feet.
- Inserting foreign objects into the power outlet.
- Using malfunctioning electric appliances.
- Inserting inappropriate or badly fitting plugs into the power outlet.

 NOTICE

■ To avoid damaging the power outlet and the plug

- Close the power outlet lid when not in use.
- Foreign objects or liquids that enter the power outlet may cause a short circuit.
- Do not use plug adaptors to connect too many plugs to the power outlet.
- After inserting a plug, gently close the power outlet lid.

■ To prevent the fuse from being blown

▶ **12 V**

Do not use an accessory that uses more than 12 V 10 A.

▶ **120 V AC**

Do not use a 120 V AC appliance that requires more than 100 W.

If a 120 V AC appliance that consumes more than 100 W is used, the protection circuit will cut the power supply.

■ Appliances that may not operate properly (120 V AC)

The following 120 V AC appliances may not operate even if their power consumption is under 100 W.

- Appliances with high initial peak wattage
- Measuring devices that process precise data
- Other appliances that require an extremely stable power supply

■ To prevent the battery from being discharged

Turn off all the vehicle's electronic equipment and accessories, such as the headlights and air conditioning, when electrical appliances that consume in excess of 100 W are used continuously for long periods of time.

■ To prevent any damage caused by heat

- Do not use any electrical appliances that give off intense heat such as toasters, in any locations including the internal or external trim, seats and deck.
- Do not use any electrical appliances, which are easily affected by vibration or heat, inside the vehicle.
Vibration while driving, or the heat of the sun while parking, may result in damage to those electrical appliances.

**NOTICE****■ If any electrical appliances are to be used while driving**

Securely fasten both the appliances and their cables to prevent them from falling or getting caught any of the power train components.

■ If the power outlet is loose when an electrical appliance plug is connected

Replace the outlet.

Contact a Toyota dealer for any necessary replacements.

■ If the power outlet gets dirty

Turn the main switch off and use a soft, clean cloth to wipe it gently.

Do not use any cleansing materials, such as organic solvents, wax, or compound cleaners, as these may damage the power outlet or cause it to malfunction.

Seat heaters*

■ Front seat

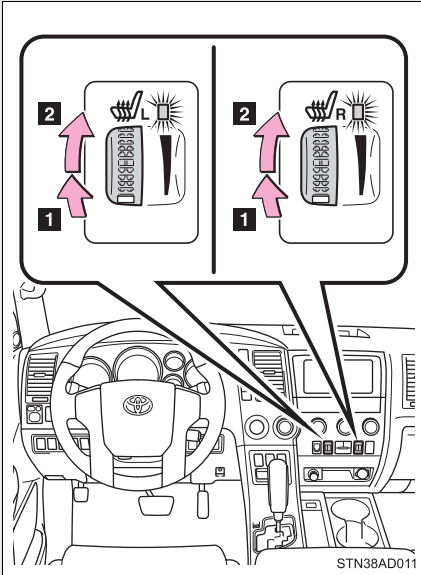

1 On

The indicator comes on.

2 Adjusts the seat temperature.

The further you turn the dial upward, the warmer the seat becomes.

*: If equipped

■ Rear seat (vehicles with rear console box)

Press the LO or HI switch to warm the seats to a low or high temperature respectively.

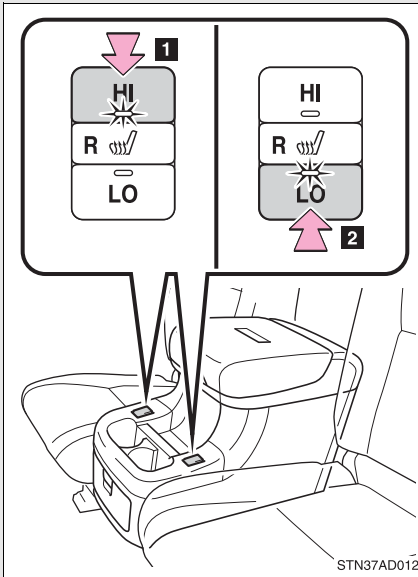

1 High temperature

The indicator (yellow) comes on.

2 Low temperature

The indicator (green) comes on.

■ The seat heaters can be used when

The engine switch is in the ON position.

■ When not in use

Front seat: Turn the dial fully downward. The indicator turns off.

Rear seat (vehicles with rear console box): Push lightly on the opposite side. The indicator turns off.

 CAUTION

■ **Burns**

- Use caution when seating the following persons in a seat with the seat heater on to avoid the possibility of burns:
 - Babies, small children, the elderly, the sick and the disabled
 - Persons with sensitive skin
 - Persons who are fatigued
 - Persons who have taken alcohol or drugs that induce sleep (sleeping drugs, cold remedies, etc.)
- Do not cover the seat with anything when using the seat heater. Using the seat heater with a blanket or cushion increases the temperature of the seat and may lead to overheating.

 NOTICE

■ **To prevent seat heater damage**

Do not put unevenly weighted objects on the seat and do not stick sharp objects (needles, nails, etc.) into the seat.

■ **To prevent battery discharge**

Turn the switches off when the engine is not running.

3-5. Using the other interior features

Seat heaters and ventilators*

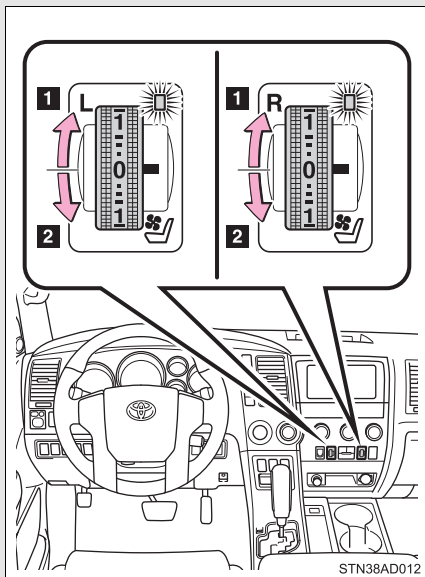

1 Blows air from the seats

The indicator comes on. The higher the number, the stronger the airflow becomes.

2 Heats the seats

The indicator comes on. The higher the number, the warmer the seats become.

■ The seat heaters can be used when

The engine switch is in the ON position.

■ When not in use

Set the dial to 0. The indicator turns off.

 CAUTION

■ **Burns**

- Use caution when seating the following persons in a seat with the seat heater on to avoid the possibility of burns:
 - Babies, small children, the elderly, the sick and the disabled
 - Persons with sensitive skin
 - Persons who are fatigued
 - Persons who have taken alcohol or drugs that induce sleep (sleeping drugs, cold remedies, etc.)
- Do not cover the seat with anything when using the seat heater. Using the seat heater with a blanket or cushion increases the temperature of the seat and may lead to overheating.

 NOTICE

■ **To prevent seat heater damage**

Do not put unevenly weighted objects on the seat and do not stick sharp objects (needles, nails, etc.) into the seat.

■ **To prevent battery discharge**

Turn the switches off when the engine is not running.

3-5. Using the other interior features

Armrests*

▶ Separated seat

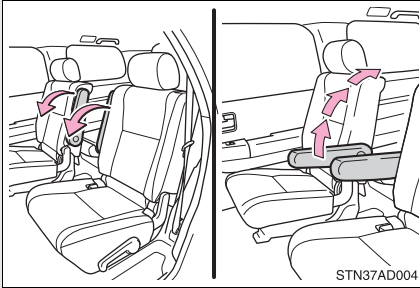

Adjusting to the desired angle:

STEP 1 Lower the armrest from the highest position to the lowest position.

STEP 2 Raise the armrest to the desired angle.

Unlock the armrest:
Lift the armrest to raise it to the highest position.

▶ Bench seat

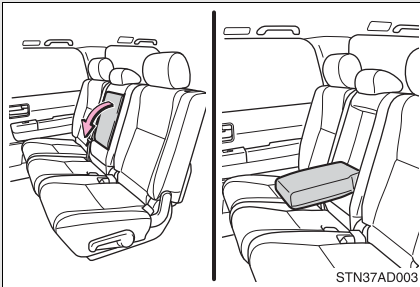

Pull the armrest down for use.

NOTICE

■ To prevent damage to the armrest

- Do not place too much strain on the armrest.
- Do not sit on the armrest.

3-5. Using the other interior features

Rear side sunshades*

► Rear door window

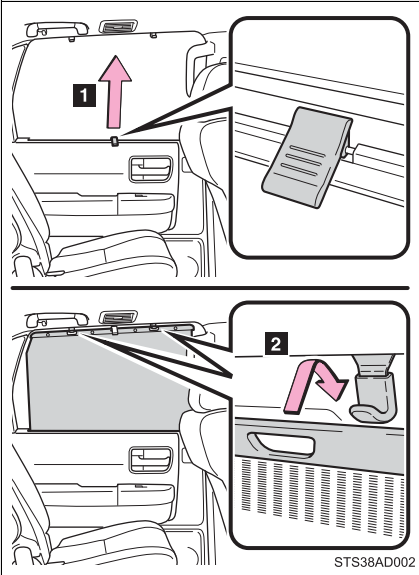

- 1** Pull the tab up.
- 2** Hook the sunshade onto the anchors.

To lower the sunshade, pull the tab slightly to unhook the shade, and lower it slowly.

*: If equipped

► Rear quarter window

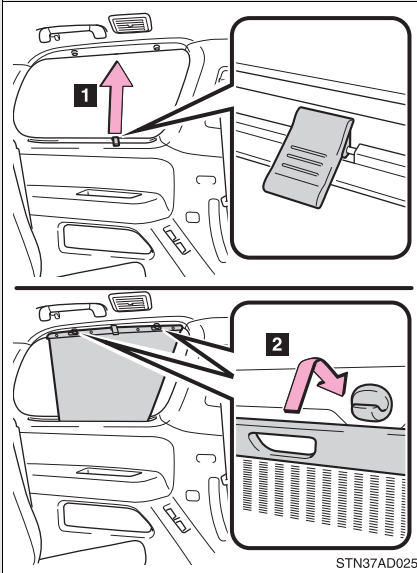

1 Pull the tab up.

2 Hook the sunshade onto the anchors.

To lower the sunshade, pull the tab slightly to unhook the shade, and lower it slowly.

 NOTICE

■ To ensure normal operation of the sunshade

Observe the following precautions.

- Do not place anything where it may hinder the opening/closing of the sunshade.
- Do not place anything on the sunshade.

Assist grips

An assist grip (type A) installed on the ceiling can be used to support your body while sitting on the seat.

An assist grip (type B) installed on the pillar can be used when getting in or out of the vehicle and others.

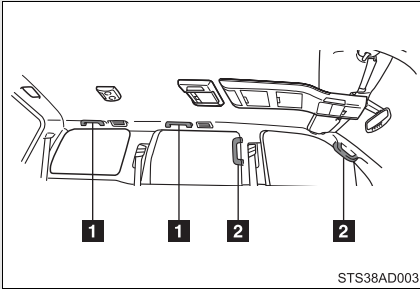

1 Assist grip (type A)

2 Assist grip (type B)

⚠ CAUTION

■ Assist grip (type A)

Do not use the assist grip (type A) when getting in or out of the vehicle or rising from your seat.

⚠ NOTICE

■ To prevent damage to the assist grip

Do not hang any heavy object or put a heavy load on the assist grip.

3-5. Using the other interior features

Floor mat

Use only floor mats designed specifically for vehicles of the same model and model year as your vehicle. Fix them securely in place onto the carpet.

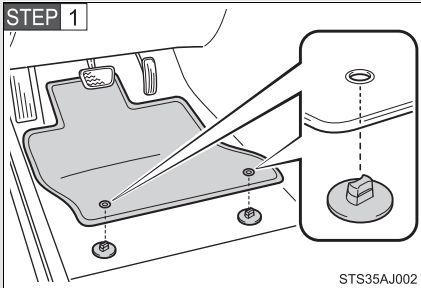

Insert the retaining hooks (clips) into the floor mat eyelets.

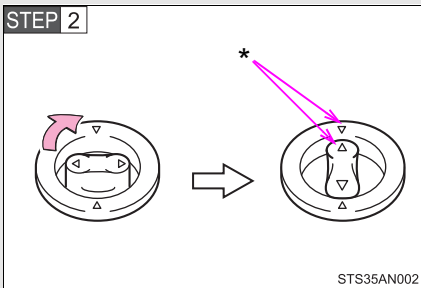

Turn the upper knob of each retaining hook (clip) to secure the floor mats in place.

*: Always align the \triangle marks.

The shape of the retaining hooks (clips) may differ from that shown in the illustration.

! CAUTION

Observe the following precautions.

Failure to do so may cause the driver's floor mat to slip, possibly interfering with the pedals while driving. An unexpectedly high speed may result or it may become difficult to stop the vehicle. This could lead to an accident, resulting in death or serious injury.

■ When installing the driver's floor mat

- Do not use floor mats designed for other models or different model year vehicles, even if they are Toyota Genuine floor mats.
- Only use floor mats designed for the driver's seat.
- Always install the floor mat securely using the retaining hooks (clips) provided.
- Do not use two or more floor mats on top of each other.
- Do not place the floor mat bottom-side up or upside-down.

■ Before driving

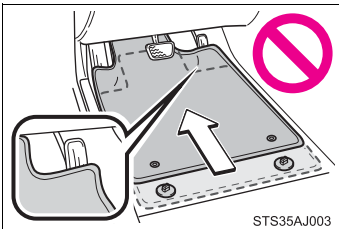

- Check that the floor mat is securely fixed in the correct place with all the provided retaining hooks (clips). Be especially careful to perform this check after cleaning the floor.
- With the engine stopped and the shift lever in P, fully depress each pedal to the floor to make sure it does not interfere with the floor mat.

3-5. Using the other interior features

Luggage compartment features

■ Tie-down hooks

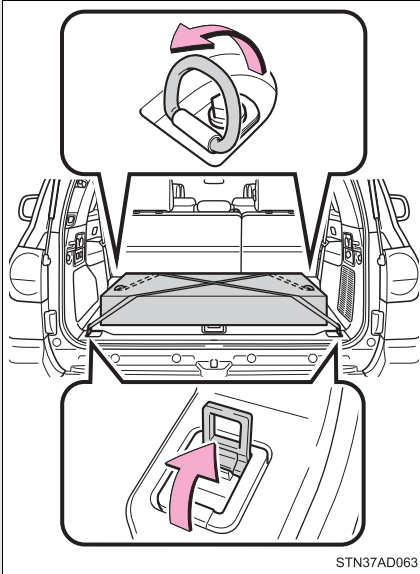

Tie-down hooks are provided for securing loose items.

■ **Cargo net hooks**

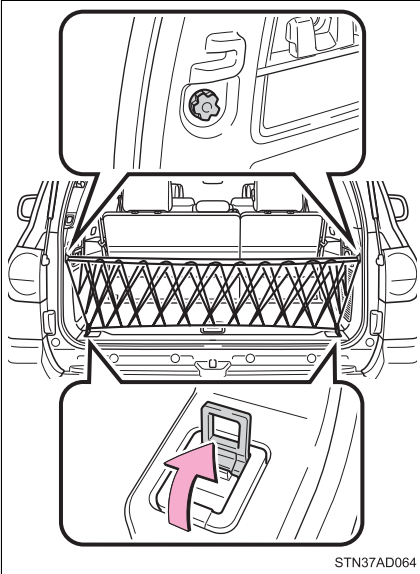

To hang the cargo net, use the cargo net hooks.

The cargo net itself is not included as original equipment.

■ Shopping bag hooks

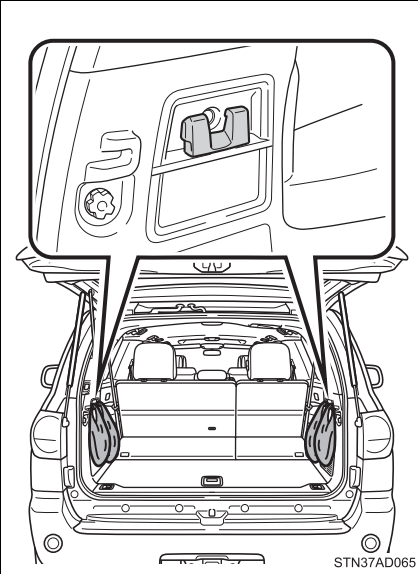

To hang shopping bags, use the shopping bag hooks.

■ **Auxiliary boxes**

▶ **Type A**

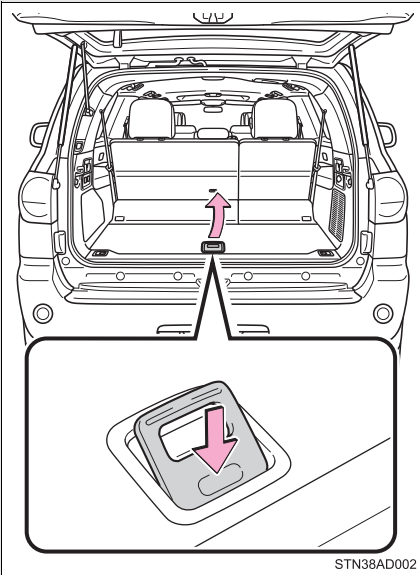

Pull the lever upwards to lift the deck board.

▶ **Type B (if equipped)**

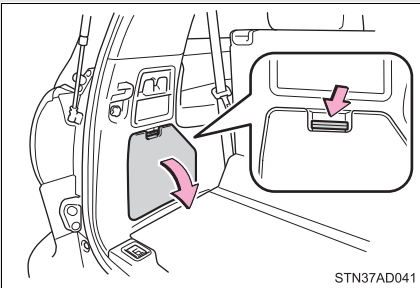

Open the cover.

 CAUTION

■ **When the tie-down hooks are not in use**

To avoid injury, always return the tie-down hooks to their retracted positions when they are not in use.

■ **Caution while driving**

Keep the auxiliary box closed. Injuries may result in the event of an accident or sudden braking.

3-5. Using the other interior features

Garage door opener*

The garage door opener can be programmed to operate garage doors, gates, entry doors, door locks, home lighting systems, security systems, and other devices.

The garage door opener (HomeLink® Universal Transceiver) is manufactured under license from HomeLink®.

Programming the HomeLink® (for U.S.A. owners)

The HomeLink® compatible transceiver in your vehicle has 3 buttons which can be programmed to operate 3 different devices. Refer to the programming method below appropriate for the device.

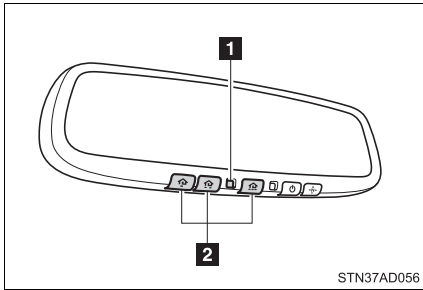

1 Indicator

2 Buttons

■ Programming the HomeLink®

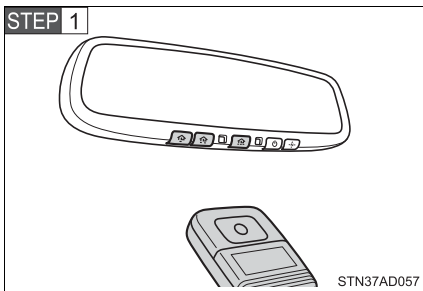

Point the remote control transmitter for the device 1 to 3 in. (25 to 75 mm) from the HomeLink® control buttons.

Keep the indicator on the HomeLink® in view while programming.

*: If equipped

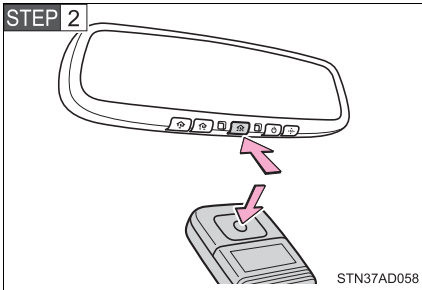

Press and hold down one of the buttons on the HomeLink[®] and the button on the transmitter. When the indicator on the HomeLink[®] changes from a slow to a rapid flash, you can release both buttons.

If the HomeLink[®] indicator comes on but does not flash, or flashes rapidly for 2 seconds and remains lit, the HomeLink[®] button is already programmed. Use the other buttons or follow the “Reprogramming a HomeLink[®] button” instructions. (→P. 373)

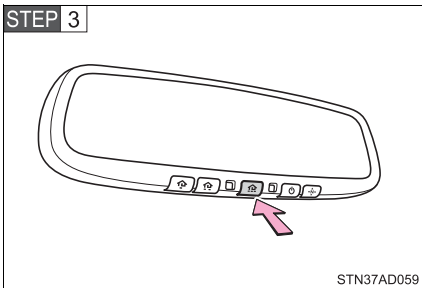

Test the operation of the HomeLink[®] by pressing the newly programmed button.

If programming a garage door opener, check to see if the garage door opens and closes. If the garage door does not operate, see if your garage transmitter is of the Rolling Code type. Press and hold the programmed HomeLink[®] button. The garage door has the rolling code feature if the indicator (on the HomeLink[®]) flashes rapidly for 2 seconds and then remains lit. If your transmitter is the Rolling Code type, proceed to the heading “Programming a rolling code system”.

STEP 4 Repeat the steps above to program another device for each of the remaining HomeLink[®] buttons.

■ Programming a Rolling Code system (for U.S.A. owners)

If your device is Rolling Code equipped, follow the steps under the heading “Programming the HomeLink®” before proceeding with the steps listed below.

STEP 1 Locate the training button on the ceiling mounted garage door opener motor. The exact location and color of the button may vary by brand of garage door opener.

Refer to the operation manual supplied with the garage door opener for the location of the training button.

STEP 2 Press the training button.

Following this step, you have 30 seconds in which to initiate step 3 below.

STEP 3 Press and hold the vehicle’s programmed HomeLink® button for 2 seconds and release it. Repeat this step once again. The garage door may open.

If the garage door opens, the programming process is complete. If the door does not open, press and release the button a third time. This third press and release will complete the programming process by opening the garage door.

The ceiling mounted garage door opener motor should now recognize the HomeLink® transceiver and operate the garage door.

STEP 4 Repeat the steps above to program another rolling code system for any of the remaining HomeLink® buttons.

■ Programming an entry gate (for U.S.A. owners)/Programming all devices in the Canadian market

STEP 1 Place your transmitter 1 to 3 in. (25 to 75 mm) away from the surface of the HomeLink®.

Keep the indicator on the HomeLink® in view while programming.

STEP 2 Press and hold the selected HomeLink® button.

STEP 3 Repeatedly press and release (cycle) the device’s remote control button for two seconds each until step 4 is completed.

STEP 4 When the indicator on the HomeLink® compatible transceiver start to flashing rapidly, release the buttons.

STEP 5 Test the operation of the HomeLink[®] by pressing the newly programmed button. Check to see if the gate/device operates correctly.

STEP 6 Repeat the steps above to program another device for each of the remaining HomeLink[®] buttons.

■ Programming other devices

To program other devices such as home security systems, home door locks or lighting, contact your authorized Toyota dealer for assistance.

■ Reprogramming a button

The individual HomeLink[®] buttons cannot be erased but can be reprogrammed. To reprogram a button, follow the programming instructions.

Operating the HomeLink[®]

Press the appropriate HomeLink[®] button. The HomeLink[®] indicator on the HomeLink[®] transceiver should turn on.

The HomeLink[®] continues to send a signal for a maximum of 20 seconds as long as the button is pressed.

Reprogramming a HomeLink[®] button

Press and hold the desired HomeLink[®] button. After 20 seconds, the HomeLink[®] indicator light will start flashing slowly. Keep pressing the HomeLink[®] button and then follow the “Programming the HomeLink[®] (for U.S.A. owners)” instructions. (→P. 370)

Erasing the entire HomeLink[®] memory (all three programs)

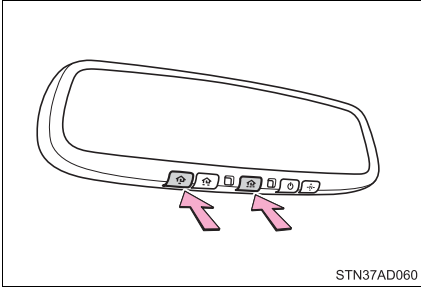

Press and hold down the 2 outside buttons for 10 seconds until the indicator flashes.

If you sell your vehicle, be sure to erase the programs stored in the HomeLink[®] memory.

■ Before programming

- Install a new battery in the remote control transmitter.
- The battery side of the remote control transmitter must be pointed away from the HomeLink[®].

■ Certification for the garage door opener

- ▶ For vehicles sold in the U.S.A.

FCC ID: NZLWZLHL4

NOTE:

This device complies with part 15 of the FCC Rules.

Operation is subject to the following two conditions: (1) This device may not cause harmful interference, and (2) this device must accept any interference received, including interference that may cause undesired operation.

FCC WARNING:

Changes or modifications not expressly approved by the party responsible for compliance could void the user's authority to operate the equipment.

- ▶ For vehicles sold in Canada

NOTE:

This device complies with Industry Canada licence-exempt RSS standard(s). Operation is subject to the following two conditions: (1) this device may not cause interference, and (2) this device must accept any interference, including interference that may cause undesired operation of the device.

■ When support is necessary

Visit on the web at www.homelink.com or call 1-800-355-3515.

⚠ CAUTION**■ When programming a garage door or other remote control device**

The garage door may operate, so ensure that people and objects are out of danger to prevent potential harm.

■ Conforming to federal safety standards

Do not use the HomeLink[®] Compatible Transceiver with any garage door opener or device that lacks safety stop and reverse features as required by federal safety standards.

This includes any garage door that cannot detect an obstruction object. A door or device without these features increases the risk of death or serious injury.

Compass*

The compass on the inside rear view mirror indicates the direction in which the vehicle is heading.

■ Operation

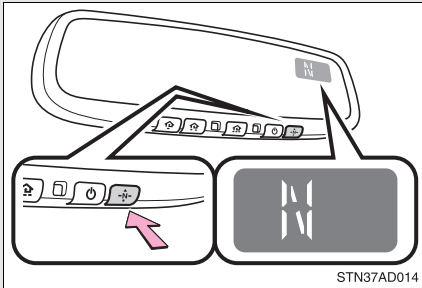

To turn the compass on or off, press the switch.

■ Displays and directions

Display	Direction
N	North
NE	Northeast
E	East
SE	Southeast
S	South
SW	Southwest
W	West
NW	Northwest

*: If equipped

Calibrating the compass

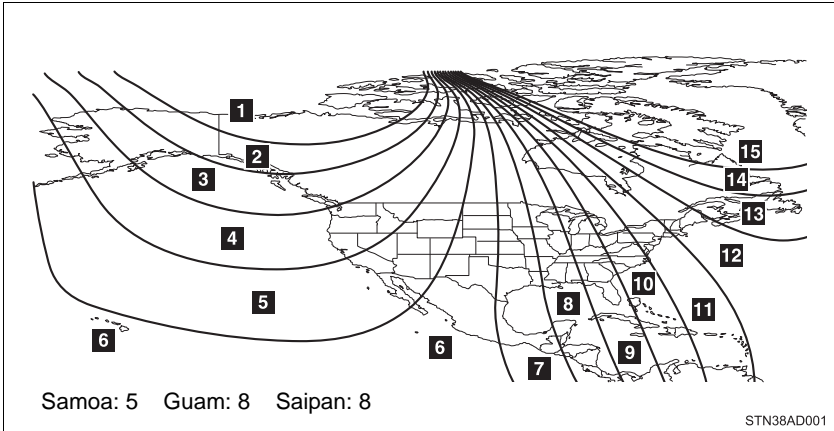

The direction display deviates from the true direction determined by the earth's magnetic field. The amount of deviation varies according to the geographic position of the vehicle.

If you cross over a map boundary shown in illustration, the compass will deviate.

To obtain higher precision or accurate calibration, refer to the following.

■ Deviation calibration

STEP 1 Stop the vehicle where it is safe to drive in a circle.

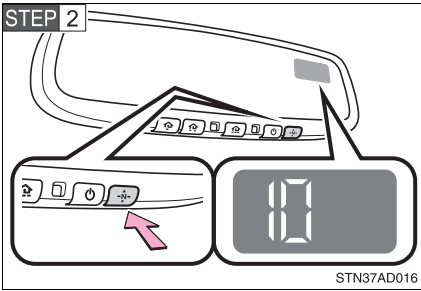

Press the switch until a number (1 to 15) appears on the compass display.

STEP 3 Press the switch, and referring to the map above, select the number of the zone where you are.

If the direction is displayed several seconds after adjustment, the calibration is complete.

■ Circling calibration

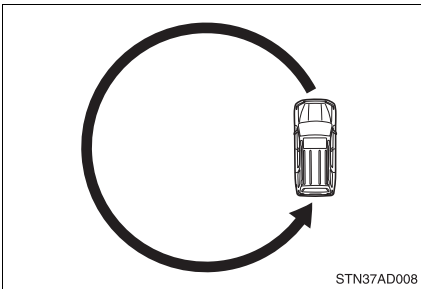

When "C" appears on the display, drive the vehicle at 5 mph (8 km/h) or less in a circle until a direction is displayed.

If there is not enough space to drive in a circle, drive around the block until the direction is displayed.

■ Conditions unfavorable to correct operation

The compass may not show the correct direction in the following conditions:

- The vehicle is stopped immediately after turning.
- The vehicle is on an inclined surface.
- The vehicle is in a place where the earth's magnetic field is subject to interference by artificial magnetic fields (underground car park/parking lot, under a steel tower, between buildings, roof car park/parking lot, near an intersection, near a large vehicle, etc.).
- The vehicle has become magnetized.
(There is a magnet or metal object near the inside rear view mirror.)
- The battery has been disconnected.
- A door is open.

CAUTION

■ While driving the vehicle

Do not adjust the display. Be sure to adjust the display only when the vehicle is stopped.

■ When doing the circling calibration

Be sure to secure a wide space, and watch out for people and vehicles in the neighborhood. Do not violate any local traffic rules while performing circling calibration.

NOTICE

■ To avoid the compass malfunctions

Do not place magnets or any metal objects near the inside rear view mirror. Doing this may cause a malfunction of the compass sensor.

■ To ensure normal operation of the compass

- Do not perform circling calibration of the compass in a place where the earth's magnetic field is subject to interference by artificial magnetic fields.
- During calibration, do not operate electric systems (moon roof, power windows, etc.) as they may interfere with the calibration.

4-1. Maintenance and care

Cleaning and protecting
the vehicle exterior..... 382

Cleaning and protecting
the vehicle interior..... 385

4-2. Maintenance

Maintenance
requirements 388

General maintenance..... 391

Emission inspection and
maintenance (I/M)
programs 394

4-3. Do-it-yourself maintenance

Do-it-yourself service
precautions 395

Hood 399

Engine compartment..... 400

Tires 415

Tire inflation pressure 423

Wheels 427

Air conditioning filter..... 430

Wireless remote control
battery 433

Checking and replacing
fuses 435

Light bulbs..... 447

Cleaning and protecting the vehicle exterior

Perform the following to protect the vehicle and maintain it in prime condition.

- Working from top to bottom, liberally apply water to the vehicle body, wheel wells and underside of the vehicle to remove any dirt and dust.
Wash the vehicle body using a sponge or soft cloth, such as a chamois.
- For hard-to-remove marks, use car wash soap and rinse thoroughly with water.
- Wipe away any water.
- Wax the vehicle when the waterproof coating deteriorates.

If water does not bead on a clean surface, apply wax when the vehicle body is cool.

■ Automatic car washes

- Fold the mirrors back before washing the vehicle.
- Brushes used in automatic car washes may scratch the vehicle surface and harm your vehicle's paint.

■ High pressure car washes

Do not allow the nozzles of the car wash to come within close proximity of the windows. Before entering an automatic car wash, check that the fuel filler door on your vehicle is closed properly.

■ Aluminum wheels

- Remove any dirt immediately by using a neutral detergent. Do not use hard brushes or abrasive cleaners. Do not use strong or harsh chemical cleaners. Use the same mild detergent and wax as used on the paint.
- Do not use detergent on the wheels when they are hot, for example after driving for long distance in the hot weather.
- Wash detergent from the wheels immediately after use.

■ Bumpers and side moldings

Do not scrub with abrasive cleaners.

⚠ CAUTION**■ Caution about the exhaust pipe**

Exhaust gasses cause the exhaust pipe to become quite hot.

When washing the vehicle, be careful not to touch the pipe until it has cooled sufficiently, as touching a hot exhaust pipe can cause burns.

■ Precaution regarding the Blind Spot Monitor

If the paint of the rear bumper is chipped or scratched, the system may malfunction. If this occurs, consult your Toyota dealer.

 NOTICE

■ **To prevent paint deterioration and corrosion on the body and components (aluminum wheels etc.)**

● Wash the vehicle immediately in the following cases:

- After driving near the sea coast
- After driving on salted roads
- If you see coal tar or tree sap on the paint surface
- If you see dead insects, insect droppings or bird droppings on the paint
- After driving in an area contaminated with soot, oily smoke, mine dust, iron powder or chemical substances
- If the vehicle becomes heavily soiled in dust or mud
- If liquids such as benzene and gasoline are spilled on the paint surface

● If the paint is chipped or scratched, have it repaired immediately.

● To prevent the wheels from corroding, remove any dirt and store in a place with low humidity when storing the wheels.

■ **Cleaning the exterior lights**

● Wash carefully. Do not use organic substances or scrub with a hard brush. This may damage the surfaces of the lights.

● Do not apply wax on the surfaces of the lights. Wax may cause damage to the lenses.

■ **When using a high pressure car wash**

Do not bring the nozzle tip close to boots (rubber or resin manufactured cover), connectors or the following parts. The parts may be damaged if they come into contact with high-pressure water.

- Traction related parts
- Steering parts
- Suspension parts
- Brake parts

The following procedures will help protect your vehicle's interior and keep it in top condition:

■ **Protecting the vehicle interior**

Remove dirt and dust using a vacuum cleaner. Wipe dirty surfaces with a cloth dampened with lukewarm water.

■ **Cleaning the leather areas**

- Remove dirt and dust using a vacuum cleaner.
- Wipe any excess dirt and dust with a soft cloth dampened with diluted detergent.

Use a diluted water solution of approximately 5% neutral wool detergent.

- Wring out any excess water from the cloth and thoroughly wipe off all remaining traces of detergent.
- Wipe the surface with a dry, soft cloth to remove any remaining moisture. Allow the leather to dry in a shaded and ventilated area.

■ **Synthetic leather areas**

- Remove loose dirt using a vacuum cleaner.
- Apply a mild soap solution to the synthetic leather using a sponge or soft cloth.
- Allow the solution to soak in for a few minutes. Remove the dirt and wipe off the solution with a clean, damp cloth.

■ Caring for leather areas

Toyota recommends cleaning the interior of the vehicle at least twice a year to maintain the quality of the vehicle's interior.

■ Shampooing the carpets

There are several commercial foaming-type cleaners available. Use a sponge or brush to apply the foam. Rub in overlapping circles. Do not apply water. Excellent results are obtained when keeping the carpet as dry as possible.

■ Seat belts

Clean with mild soap and lukewarm water using a cloth or sponge. Also check the belts periodically for excessive wear, fraying or cuts.

CAUTION

■ Water in the vehicle

- Do not splash or spill liquid in the vehicle. Doing so may cause the electrical components etc. to malfunction or catch fire.
- Do not get any of the SRS components or wiring in the vehicle interior wet. (→P. 113)

Electrical malfunction may cause the airbags to deploy or not function properly, resulting in death or severe injury.

■ Cleaning the interior (especially instrument panel)

Do not use polish wax or polish cleaner. The instrument panel may reflect off the windshield, obstructing the driver's view and leading to an accident, resulting in death or serious injury.

 NOTICE**■ Cleaning detergents**

- Do not use organic substances such as benzene or gasoline, acidic or alkaline solutions, dye, bleach or other detergent. Doing so may discolor the vehicle interior or cause streaks or damage to painted surfaces.
- Do not use polish wax or polish cleaner. The instrument panel's or other interior part's painted surface may be damaged.

■ Preventing damage to leather surfaces

Observe the following precautions to avoid damage to and deterioration of leather surfaces.

- Remove any dust or dirt on leather surfaces immediately.
- Do not expose the vehicle to direct sunlight for extended periods of time. Park the vehicle in the shade, especially during summer.
- Do not place items made of vinyl or plastic, or that contain wax on the upholstery, as they may stick to the leather surface if the vehicle interior heats up significantly.

■ Water on the floor

Do not wash the vehicle floor with water.

Vehicle systems such as the audio system may be damaged if water comes into contact with electrical components under the floor of the vehicle, and may also cause the body to rust.

■ Cleaning the inside of the back window and the rear quarter windows

- Do not use glass cleaner to clean the back window and the rear quarter windows, as this may cause damage to the rear window defogger heater wires or antennas. Use a cloth dampened with lukewarm water to gently wipe the window clean. Wipe the window in strokes running parallel to the heater wires.
- Be careful not to scratch or damage the heater wires or antennas.

Maintenance requirements

To ensure safe and economical driving, day-to-day care and regular maintenance are essential. It is the owner's responsibility to perform regular checks. Toyota recommends the following maintenance.

■ General maintenance

Should be performed on a daily basis. This can be done by yourself or by a Toyota dealer.

■ Scheduled maintenance

Should be performed at specified intervals according to the maintenance schedule.

For details about maintenance items and schedules, refer to the "Scheduled Maintenance Guide" or "Owner's Manual Supplement".

■ Do-it-yourself maintenance

You can perform some maintenance procedures yourself. Please be aware that do-it-yourself maintenance may affect warranty coverage.

The use of Toyota Repair Manuals is recommended.

For details about warranty coverage, see the separate "Owner's Warranty Information Booklet", "Owner's Manual Supplement".

■ Repair and replacement

It is recommended that genuine Toyota parts be used for repair to ensure performance of each system. If non-Toyota parts are used in replacement or if a repair shop other than Toyota dealer performs repairs, confirm the warranty coverage.

Flex-fuel vehicles: Flex-fuel vehicles use special parts made exclusively for flex-fuel vehicles. When servicing or repairing your vehicles, use genuine Toyota parts made exclusively for your flex-fuel vehicle.

■ **Resetting the maintenance required reminder light (vehicles without multi-information display) or the message indicating maintenance is required (vehicles with multi-information display) (U.S.A. only)**

After the required maintenance is performed according to the maintenance schedule, please reset the reminder light or message.

To reset the reminder light or message, follow the procedures described below:

STEP 1 Turn the engine switch off with the trip meter A reading shown.

STEP 2 While pressing the trip meter reset button (→P. 168), turn the engine switch on.

▶ Without multi-information display

STEP 3 Continue to press and hold the button until the trip meter displays 000000.

▶ With multi-information display

STEP 3 Continue to press and hold the button until “MAINT REQD RESET MODE COMPLETE” appears on the multi-information display.

■ **Allow inspection and repairs to be performed by a Toyota dealer**

- Toyota technicians are well-trained specialists and are kept up to date with the latest service information. They are well informed about the operations of all systems on your vehicle.
- Keep a copy of the repair order. It proves that the maintenance that has been performed is under warranty coverage. If any problem should arise while your vehicle is under warranty, your Toyota dealer will promptly take care of it.

 CAUTION

■ **Warning in handling of battery**

- Engine exhaust, some of its constituents, and a wide variety of automobile components contain or emit chemicals known to the State of California to cause cancer and birth defects and other reproductive harm. Work in a well ventilated area.
- Oils, fuels and fluids contained in vehicles as well as waste produced by component wear contain or emit chemicals known to the State of California to cause cancer and birth defects or other reproductive harm. Avoid exposure and wash any affected area immediately.
- Battery posts, terminals and related accessories contain lead and lead compounds which are known to cause brain damage. Wash your hands after handling. (→P. 410)

General maintenance

Listed below are the general maintenance items that should be performed at the intervals specified in the “Scheduled Maintenance Guide” or “Owner’s Manual Supplement”. It is recommended that any problem you notice should be brought to the attention of your Toyota dealer or qualified service shop for advice.

Engine compartment

Items	Check points
Battery	Maintenance-free. (→P. 410)
Brake fluid	At the correct level? (→P. 407)
Engine coolant	At the correct level? (→P. 405)
Engine oil	At the correct level? (→P. 401)
Exhaust system	No fumes or strange sounds?
Power steering fluid	At the correct level? (→P. 409)
Radiator/condenser/hoses	Not blocked with foreign matter? (→P. 407)
Washer fluid	At the correct level? (→P. 413)

Vehicle interior

Items	Check points
Accelerator pedal	<ul style="list-style-type: none"> • Moves smoothly (without uneven pedal effort or catching)?
Automatic transmission “Park” mechanism	<ul style="list-style-type: none"> • Can the vehicle be held securely on an incline with the shift lever in P?
Brake pedal	<ul style="list-style-type: none"> • Moves smoothly? • Does it have appropriate clearance and correct amount of free play?
Brakes	<ul style="list-style-type: none"> • Not pull to one side when applied? • Loss of brake effectiveness? • Spongy feeling brake pedal? • Pedal almost touches floor?
Head restraints	<ul style="list-style-type: none"> • Move smoothly and lock securely?
Indicators/buzzers	<ul style="list-style-type: none"> • Function properly?
Lights	<ul style="list-style-type: none"> • Do all the lights come on? • Headlights aimed correctly?
Parking brake	<ul style="list-style-type: none"> • Moves smoothly? • Can hold the vehicle securely on an incline?
Seat belts	<ul style="list-style-type: none"> • Does the seat belt system operate smoothly? • Are the belts undamaged?
Seats	<ul style="list-style-type: none"> • Do the seat controls operate properly?
Steering wheel	<ul style="list-style-type: none"> • Moves smoothly? • Has correct free play? • No strange noises?

Vehicle exterior

Items	Check points
Doors	<ul style="list-style-type: none"> • Operate smoothly?
Engine hood	<ul style="list-style-type: none"> • The lock system works properly?
Fluid leaks	<ul style="list-style-type: none"> • Is there any leakage after parking?
Tire	<ul style="list-style-type: none"> • Inflation pressure is correct? • Tire surfaces not worn or damaged? • Tires rotated according to the maintenance schedule? • Wheel nuts are not loose?
Windshield wipers/rear window wiper	<ul style="list-style-type: none"> • The wiper blades should not show any signs of cracking, splitting, wear, contamination or deformation. • The wiper blades should clear the windshield/rear window without streaking or skipping.

CAUTION

■ If the engine is running

Turn the engine off and ensure that there is adequate ventilation before performing maintenance checks.

Some states have vehicle emission inspection programs which include OBD (On Board Diagnostics) checks. The OBD system monitors the operation of the emission control system.

■ **If the malfunction indicator lamp comes on**

The OBD system determines that a problem exists somewhere in the emission control system. Your vehicle may not pass the I/M test and may need to be repaired. Contact your Toyota dealer to service the vehicle.

■ **Your vehicle may not pass the I/M test:**

- When the battery is disconnected or discharged

Readiness codes that are set during ordinary driving are erased.

Also, depending on your driving habits, the readiness codes may not be completely set.

- When the fuel tank cap is loose

The malfunction indicator lamp comes on as a temporary malfunction and your vehicle may not pass the I/M test.

■ **When the malfunction indicator lamp goes off after several driving trips**

The error code in the OBD system will not be cleared unless the vehicle is driven 40 or more times.

■ **If your vehicle does not pass the I/M test**

Contact your Toyota dealer to prepare the vehicle for re-testing.

Do-it-yourself service precautions

If you perform maintenance yourself, be sure to follow the correct procedures as given in these sections.

Items	Parts and tools
Battery condition (→P. 410)	<ul style="list-style-type: none"> • Warm water • Baking soda • Grease • Conventional wrench (for terminal clamp bolts)
Brake fluid level (→P. 407)	<ul style="list-style-type: none"> • FMVSS No.116 DOT 3 or SAE J1703 brake fluid • Rag or paper towel
Engine coolant level (→P. 405)	<ul style="list-style-type: none"> • “Toyota Super Long Life Coolant” or similar high quality ethylene glycol based non-silicate, non-amine, non-nitrite and non-borate coolant with long-life hybrid organic acid technology. <p>U.S.A.:</p> <p>“Toyota Super Long Life Coolant” is pre-mixed with 50% coolant and 50% deionized water.</p> <p>Canada:</p> <p>“Toyota Super Long Life Coolant” is pre-mixed with 55% coolant and 45% deionized water.</p>
Engine oil level (→P. 401)	<ul style="list-style-type: none"> • Toyota Genuine Motor Oil or equivalent • Rag or paper towel • Funnel (used only for adding oil)
Fuses (→P. 435)	<ul style="list-style-type: none"> • Fuse with same amperage rating as original

Items	Parts and tools
Light bulbs (→P. 447)	<ul style="list-style-type: none"> • Bulb with same number and wattage rating as original • Phillips-head screwdriver • Flathead screwdriver
Power steering fluid level (→P. 409)	<ul style="list-style-type: none"> • Automatic transmission fluid DEXRON® II or III • Rag or paper towel • Funnel (used only for adding power steering fluid)
Radiator and condenser (→P. 407)	—
Tire inflation pressure (→P. 423)	<ul style="list-style-type: none"> • Tire pressure gauge • Compressed air source
Washer fluid (→P. 413)	<ul style="list-style-type: none"> • Washer fluid containing antifreeze (for winter use) • Water • Funnel (used only for adding washer fluid)

 **CAUTION**

The engine compartment contains many mechanisms and fluids that may move suddenly, become hot, or become electrically energized. To avoid death or serious injury observe the following precautions.

■ **When working on the engine compartment**

- Keep hands, clothing, and tools away from the moving fan and engine drive belt.
- Be careful not to touch the engine, radiator, exhaust manifold, etc. right after driving as they may be hot. Oil and other fluids may also be hot.
- Do not leave anything that may burn easily, such as paper or rags, in the engine compartment.
- Do not smoke, cause sparks or expose an open flame to fuel or the battery. Fuel and battery fumes are flammable.
- Be extremely cautious when working on the battery. It contains poisonous and corrosive sulfuric acid.
- Take care because brake fluid can harm your hands or eyes and damage painted surfaces.
If fluid gets on your hands or in your eyes, flush the affected area with clean water immediately.
If you still experience discomfort, see a doctor.

■ **When working near the cooling fans or radiator grille**

Be sure the engine switch is in the LOCK position.

With the engine switch on, the cooling fans may automatically start to run if the air conditioning is on and/or the coolant temperature is high.

■ **Safety glasses**

Wear safety glasses to prevent flying or falling material, fluid spray, etc. from getting in the eyes.



NOTICE

■ If you remove the air cleaner

Driving with the air cleaner removed may cause excessive engine wear due to dirt in the air.

■ If the brake fluid level is low or high

It is normal for the brake fluid level to go down slightly as the brake pads wear or when the brake fluid level in the accumulator is high.

If the reservoir needs frequent refilling, it may indicate a serious problem.

4-3. Do-it-yourself maintenance

Hood

Release the lock from the inside of the vehicle to open the hood.

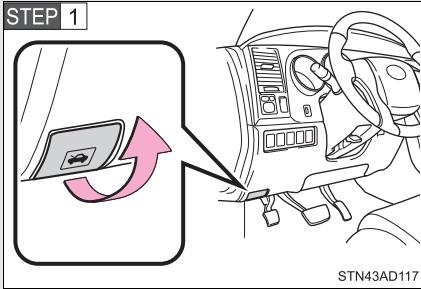

Pull the hood lock release lever.

The hood will pop up slightly.

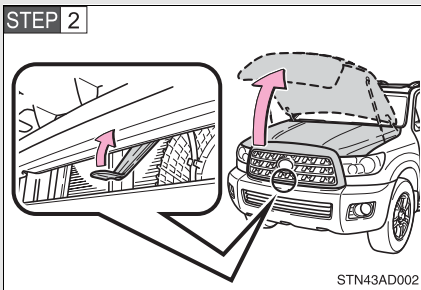

Pull up the hood catch lever and lift the hood.

⚠ CAUTION

■ Pre-driving check

Check that the hood is fully closed and locked.

If the hood is not locked properly, it may open while the vehicle is in motion and cause an accident, which may result in death or serious injury.

4-3. Do-it-yourself maintenance

Engine compartment

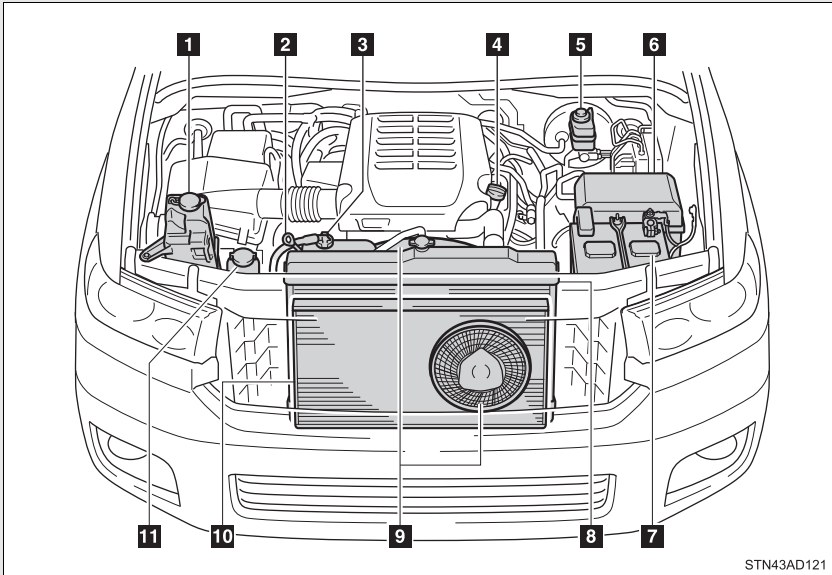

STN43AD121

- | | |
|--|--|
| 1 Washer fluid tank (→P. 413) | 5 Brake fluid reservoir (→P. 407) |
| 2 Engine oil level dipstick (→P. 401) | 6 Fuse box (→P. 435) |
| 3 Engine coolant reservoir (→P. 405) | 7 Battery (→P. 410) |
| 4 Engine oil filler cap (→P. 402) | 8 Radiator (→P. 407) |
| | 9 Cooling fans |
| | 10 Condenser (→P. 407) |
| | 11 Power steering fluid reservoir (→P. 409) |

Engine oil

With the engine at operating temperature and turned off, check the oil level on the dipstick.

■ Checking the engine oil

STEP 1 Park the vehicle on level ground. After turning off the engine, wait more than 5 minutes for the oil to drain back into the bottom of the engine.

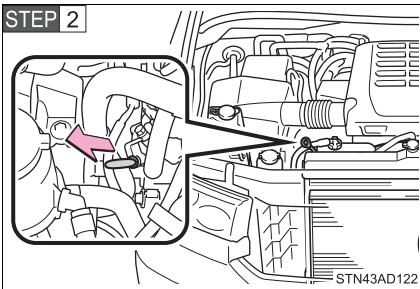

Hold a rag under the end and pull the dipstick out.

STEP 3 Wipe the dipstick clean.

STEP 4 Reinsert the dipstick fully.

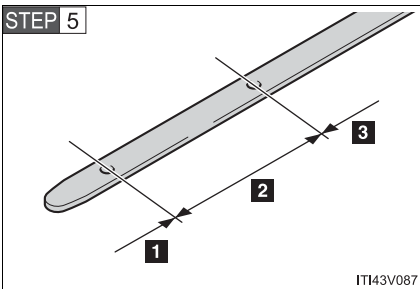

Holding a rag under the end, pull the dipstick out and check the oil level.

- 1** Low
- 2** Normal
- 3** Excessive

The shape of the dipstick may differ depending on the type of vehicle or engine.

STEP 6 Wipe the dipstick and reinsert it fully.

■ Adding engine oil

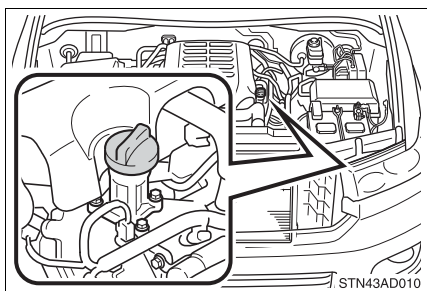

If the oil level is below or near the low level mark, add engine oil of the same type as already in the engine.

Make sure to check the oil type and prepare the items needed before adding oil.

Engine oil selection	→P. 516
Items	Clean funnel

STEP 1 Remove the oil filler cap, turning it counterclockwise.

STEP 2 Add engine oil slowly.

STEP 3 Checking the dipstick.

STEP 4 Reinstall the filler cap, turning it clockwise.

The approximate quantity of oil needed to raise the level between low and full on the dipstick is indicated as follows:

1.6 qt. (1.5 L, 1.3 Imp.qt.)

■ Engine oil consumption

A certain amount of engine oil will be consumed while driving. In the following situations, oil consumption may increase, and engine oil may need to be refilled in between oil maintenance intervals.

- When the engine is new, for example directly after purchasing the vehicle or after replacing the engine
- If low quality oil or oil of an inappropriate viscosity is used
- When driving at high engine speeds or with a heavy load, when towing, or when driving while accelerating or decelerating frequently
- When leaving the engine idling for a long time, or when driving frequently through heavy traffic

 **CAUTION**

■ **Used engine oil**

- Used engine oil contains potentially harmful contaminants which may cause skin disorders such as inflammation or skin cancer, so care should be taken to avoid prolonged and repeated contact. To remove used engine oil from your skin, wash thoroughly with soap and water.
- Dispose of used oil and filters only in a safe and acceptable manner. Do not dispose of used oil and filters in household trash, in sewers or onto the ground. Call your Toyota dealer, service station or auto parts store for information concerning recycling or disposal.
- Do not leave used engine oil within the reach of children.

 **NOTICE**

■ **To prevent serious engine damage**

Check the oil level on a regular basis.

■ **When replacing the engine oil**

- Be careful not to spill engine oil on the vehicle components.
- Avoid overfilling, as the engine could be damaged.
- Check the oil level on the dipstick every time you refill the vehicle.
- Be sure the engine oil filler cap is properly tightened.

Engine coolant

The coolant level is satisfactory if it is between the FULL and LOW lines on the reservoir when the engine is cold.

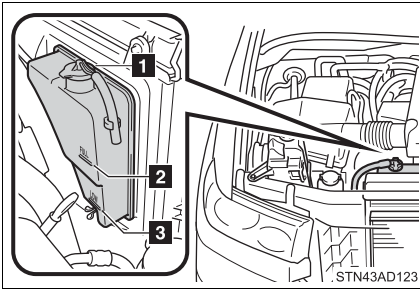

1 Reservoir cap

2 FULL

3 LOW

If the level is on or below the LOW line, add coolant up to the FULL line.

■ If the coolant level drops within a short time after replenishing

Visually check the radiator, hoses, reservoir cap, radiator cap, drain cock and water pump.

If you cannot find a leak, have your Toyota dealer pressure test the cap and check for leaks in the cooling system.

■ Coolant selection

Only use “Toyota Super Long Life Coolant” or similar high quality ethylene glycol based non-silicate, non-amine, non-nitrite and non-borate coolant with long-life hybrid organic acid technology.

U.S.A.: “Toyota Super Long Life Coolant” is a mixture of 50% coolant and 50% deionized water. (Enabled: -31°F [-35°C])

Canada: “Toyota Super Long Life Coolant” is a mixture of 55% coolant and 45% deionized water. (Enabled: -44°F [-42°C])

For more details about engine coolant, contact your Toyota dealer.

 **CAUTION**

■ **When the engine is hot**

Do not remove the radiator cap.

The cooling system may be under pressure and may spray hot coolant if the cap is removed, causing serious injuries, such as burns.

 **NOTICE**

■ **When adding engine coolant**

Coolant is neither plain water nor straight antifreeze. The correct mixture of water and antifreeze must be used to provide proper lubrication, corrosion protection and cooling. Be sure to read the antifreeze or coolant label.

■ **If you spill coolant**

Be sure to wash it off with water to prevent damage to parts or paint.

Radiator and condenser

Check the radiator and condenser and clear any foreign objects. If either of the above parts are extremely dirty or you are not sure of their condition, have your vehicle checked by your Toyota dealer.

⚠ CAUTION

■ When the engine is hot

Do not touch the radiator or condenser as they may be hot and may cause serious injuries, such as burns.

Brake fluid

■ Checking fluid level

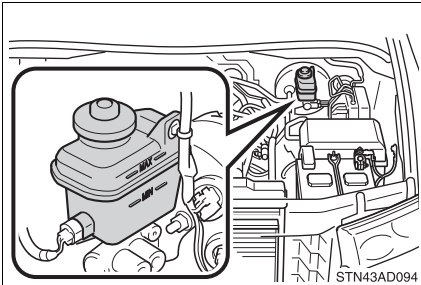

The brake fluid level should be between the MAX and MIN lines on the reservoir.

■ Adding fluid

Make sure to check the fluid type and prepare the necessary items.

Fluid type	FMVSS No.116 DOT 3 or SAE J1703 brake fluid
------------	---

■ Brake fluid can absorb moisture from the air

Excess moisture in the fluid can cause a dangerous loss of braking efficiency. Use only newly opened brake fluid.

 **CAUTION**

■ **When filling the reservoir**

Take care because brake fluid can harm your hands or eyes and damage painted surfaces.

If fluid gets on your hands or in your eyes, flush the affected area with clean water immediately.

If you still experience discomfort, see a doctor.

 **NOTICE**

■ **If the fluid level is low or high**

It is normal for the brake fluid level to go down slightly as the brake pads wear or when the fluid level in the accumulator is high.

If the reservoir needs frequent refilling, it may indicate a serious problem.

■ **If you spill fluid**

Be sure to wash it off with water to prevent damage to parts or paint.

Power steering fluid

■ Fluid level

The fluid level should be within the appropriate range.

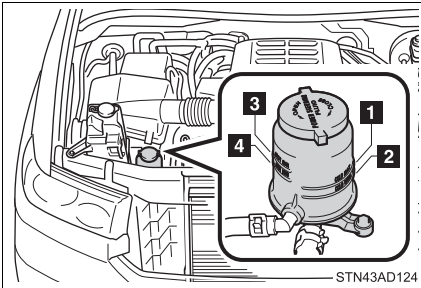

- 1 Full (when cold)
- 2 Add fluid (when cold)
- 3 Full (when hot)
- 4 Add fluid (when hot)

Hot: Vehicle has been driven around 50 mph (80 km/h) for 20 minutes, or slightly longer in frigid temperatures. (Fluid temperature, 140°F - 175°F [60°C - 80°C])

Cold: Engine has not been run for about 5 hours. (Room temperature, 50°F - 85°F [10°C - 30°C])

■ Checking the fluid level

Make sure to check the fluid type and prepare the necessary items.

Fluid type	Automatic transmission fluid DEXRON® II or III
Items	Rag or paper towel and funnel (only for adding fluid)

- STEP 1** Clean all dirt off the reservoir.
- STEP 2** Remove the cap by turning it counterclockwise.
- STEP 3** Wipe the dipstick clean.
- STEP 4** Reinstall and remove the reservoir cap again.
- STEP 5** Check the fluid level.

⚠ CAUTION

■ Checking the fluid level

Take care, as the reservoir may be hot.

⚠ NOTICE

■ When adding fluid

Avoid overfilling, or the power steering may be damaged.

■ After replacing the reservoir cap

Check the steering box case, vane pump and hose connections for leaks or damage.

Battery

■ Battery exterior

Make sure that the battery terminals are not corroded and that there are no loose connections, cracks, or loose clamps.

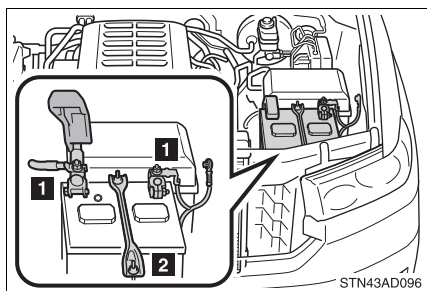

1 Terminals

2 Hold-down clamp

■ Before recharging

When recharging, the battery produces hydrogen gas which is flammable and explosive. Therefore, before recharging:

- If recharging with the battery installed on the vehicle, be sure to disconnect the ground cable.
- Make sure the power switch on the charger is off when connecting and disconnecting the charger cables to the battery.

▲ CAUTION

■ Chemicals in the battery

A battery contains poisonous and corrosive sulfuric acid and may produce hydrogen gas which is flammable and explosive. To reduce the risk of death or serious injury, take the following precautions while working on or near battery:

- Do not cause sparks by touching the battery terminals with tools.
- Do not smoke or light a match near the battery.
- Avoid contact with eyes, skin and clothes.
- Never inhale or swallow electrolyte.
- Wear protective safety glasses when working near the battery.
- Keep children away from the battery.

■ Where to safely charge the battery

Always charge the battery in an open area. Do not charge the battery in a garage or closed room where there is not sufficient ventilation.

■ How to recharge the battery

Only perform a slow charge (5A or less).
The battery may explode if charged at a quicker rate.

 **CAUTION**

■ **Emergency measures regarding electrolyte**

- If electrolyte gets in your eyes

Flush your eyes with clean water for at least 15 minutes and get immediate medical attention. If possible, continue to apply water with a sponge or cloth while traveling to the nearest medical facility.

- If electrolyte gets on your skin

Wash the affected area thoroughly. If you feel pain or burning, get medical attention immediately.

- If electrolyte gets on your clothes

It can soak through clothing on to your skin. Immediately take off the clothing and follow the procedure above if necessary.

- If you accidentally swallow electrolyte

Drink a large quantity of water or milk. Get emergency medical attention immediately.

 **NOTICE**

■ **When recharging the battery**

Never recharge the battery while the engine is running. Also, be sure all accessories are turned off.

Washer fluid

Add washer fluid in the following situations.

- The washer does not work.
- The low washer fluid warning light comes on. (vehicles without multi-information display)
- The warning message appears on the multi-information display. (vehicles with multi-information display)

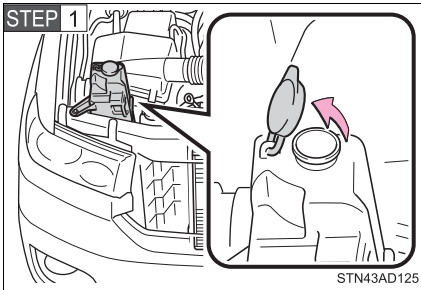

Open the lid.

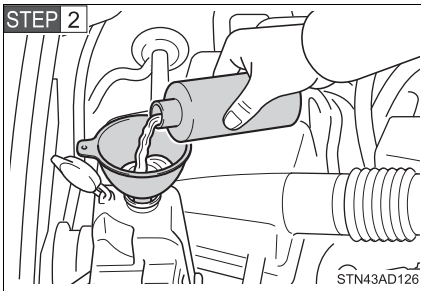

Add washer fluid.

 **CAUTION**

■ **When refilling the washer fluid**

Do not refill the washer fluid when the engine is hot or running, as the washer fluid contains alcohol and may catch fire if spilled on the engine etc.

 **NOTICE**

■ **Do not use any fluid other than washer fluid**

Do not use soapy water or engine antifreeze instead of washer fluid. Doing so may cause streaking on the vehicle's painted surfaces.

■ **Diluting washer fluid**

Dilute washer fluid with water as necessary.

Refer to the freezing temperatures listed on the label of the washer fluid bottle.

Tires

Replace or rotate tires in accordance with maintenance schedules and treadwear.

■ Checking tires

Check if the treadwear indicators are showing on the tires. Also check the tires for uneven wear, such as excessive wear on one side of the tread.

Check the spare tire condition and pressure if not rotated.

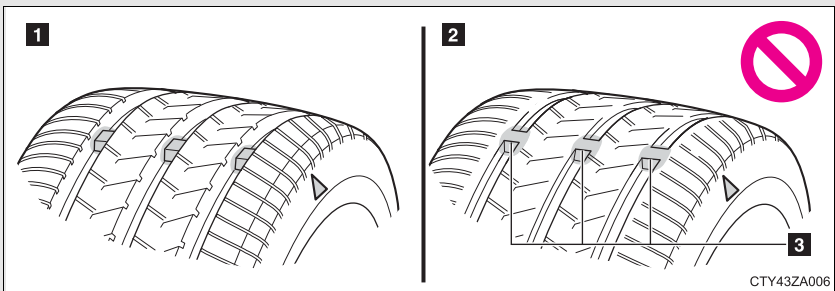

1 New tread

2 Worn tread

3 Treadwear indicator

The location of treadwear indicators is shown by a “TWI” or “△” mark, etc., molded into the sidewall of each tire.

Replace the tires if the treadwear indicators are showing on a tire.

■ Tire rotation

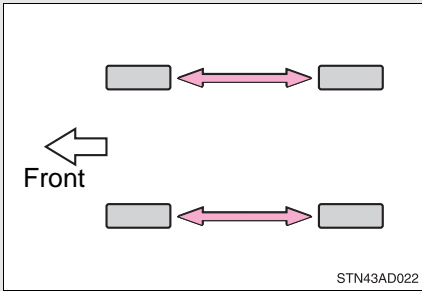

Rotate the tires in the order shown.

To equalize tire wear and extend tire life, Toyota recommends that tire rotation is carried out at the same interval as tire inspection.

Do not fail to initialize the tire pressure warning system after tire rotation.

■ The tire pressure warning system

Your Toyota is equipped with a tire pressure warning system that uses tire pressure warning valves and transmitters to detect low tire inflation pressure before serious problems arise.

(→P. 472)

Installing tire pressure warning valves and transmitters

When replacing tires or wheels, tire pressure warning valves and transmitters must also be installed.

When new tire pressure warning valves and transmitters are installed, new tire pressure warning valve and transmitter ID codes must be registered in the tire pressure warning computer and tire pressure warning system must be initialized. Have tire pressure warning valve and transmitter ID codes registered by your Toyota dealer. (→P. 418)

Initializing the tire pressure warning system

■ **The tire pressure warning system must be initialized in the following circumstances:**

- When rotating the tires on vehicles differing with front and rear tire inflation pressures.
- When changing the tire size.

When the tire pressure warning system is initialized, the current tire inflation pressure is set as the pressure benchmark.

■ **How to initialize the tire pressure warning system**

STEP 1 Park the vehicle in safe place and turn the engine switch off.

While the vehicle is moving, initialization is not performed.

STEP 2 Adjust the tire inflation pressure to the specified cold tire inflation pressure level. (→P. 521)

Make sure to adjust the tire pressure to the specified cold tire inflation pressure level. The tire pressure warning system will operate based on this pressure level.

STEP 3 Turn the engine switch to the ON position.

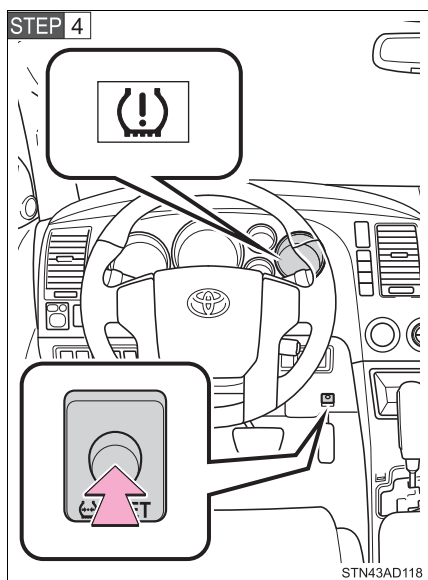

Push and hold the tire pressure warning reset switch until the tire pressure warning light blinks slowly 3 times.

STEP 5 Wait for several minutes with the engine switch on, and then turn the engine switch to the ACC or LOCK position.

Registering ID codes

The tire pressure warning valve and transmitter is equipped with a unique ID code. When replacing a tire pressure warning valve and transmitter, it is necessary to register the ID code of tire pressure warning valve and transmitter. Have the ID code registered by your Toyota dealer.

■ When to replace your vehicle's tires

Tires should be replaced if:

- The treadwear indicators are showing on a tire.
- You have tire damage such as cuts, splits, cracks deep enough to expose the fabric or bulges indicating internal damage
- A tire goes flat repeatedly or cannot be properly repaired due to the size or location of a cut or other damage

If you are not sure, consult with your Toyota dealer.

■ Replacing tires and wheels

If the ID code of the tire pressure warning valve and transmitter is not registered, the tire pressure warning system will not work properly. After driving for about 20 minutes, the tire pressure warning light comes on after blinking for 1 minute to indicate a system malfunction.

■ Tire life

Any tire over 6 years old must be checked by a qualified technician even if they have seldom or never been used or damage is not obvious.

■ If the tread wears down below 0.16 in. (4 mm) on snow tires

The effectiveness of snow tires is lost.

■ Maximum load of tire

Check that the number given by dividing the maximum load by 1.10 of the replacement tire is greater than 1/2 of the Gross Axle Weight Ratings (GAWR) of either the front axle or the rear axle, whichever is greater.

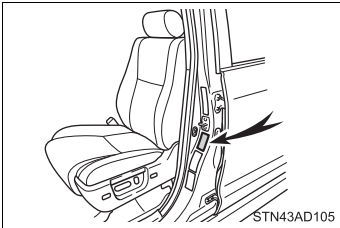

For the GAWR, see the Certification Label. For the maximum load of the tire, see the load limit at maximum cold tire inflation pressure mentioned on the sidewall of the tire. (→P. 528)

■ Tire types

1 Summer tires

Summer tires are high-speed performance tires best suited to highway driving under dry conditions. Since summer tires do not have the same traction performance as snow tires, summer tires are inadequate for driving on snow-covered or icy roads. For driving on snow-covered roads or icy roads, the use of snow tires is recommended. When installing snow tires, be sure to replace all four tires.

2 All season tires

All season tires are designed to provide better traction in snow and to be adequate for driving in most winter conditions, as well as for use year round. All season tires, however, do not have adequate traction performance compared with snow tires in heavy or loose snow. Also, all season tires fall short in acceleration and handling performance compared with summer tires in highway driving.

3 Snow tires

For driving on snow-covered roads or icy roads, we recommend using snow tires. If you need snow tires, select tires of the same size, construction and load capacity as the originally installed tires. Since your vehicle has radial tires as original equipment, make sure your snow tires also have radial construction. Do not install studded tires without first checking local regulations for possible restriction. Snow tires should be installed on all wheels. (→P. 266)

■ **Initializing the tire pressure warning system**

Initialize the tires with the tire inflation pressure adjusted to the specified level.

■ **If you push the tire pressure warning reset switch accidentally**

If initialization is performed, adjust the tire inflation pressure to the specified level and initialize the tire pressure warning system again.

■ **When the initialization of the tire pressure warning system has failed**

Initialization can be completed in several minutes. However, in the following cases, the settings have not been recorded and the system will not operate properly. If repeated attempts to record tire inflation pressure settings are unsuccessful, have the vehicle inspected by your Toyota dealer.

- When operating the tire pressure warning reset switch, the tire pressure warning light does not blink 3 times.
- After carrying out the initialization procedure, the tire pressure warning light blinks for 1 minute and then stays on after driving for about 20 minutes.

■ **Routine tire inflation pressure checks**

The tire pressure warning system does not replace routine tire inflation pressure checks. Make sure to check tire inflation pressure as part of your routine of daily vehicle checks.

■ Tire pressure warning system certification

► For vehicles sold in the U.S.A.

FCC ID: GQ4-45T

FCC ID: GQ4-37R

Note:

This device complies with Part 15 of the FCC Rules. Operation is subject to the following two conditions: (1) This device may not cause harmful interference, and (2) this device must accept any interference received, including interference that may cause undesired operation.

WARNING:

Changes or modifications not expressly approved by the party responsible for compliance could void the user's authority to operate the equipment.

► For vehicles sold in Canada

IC: 1470A-26T

IC: 1470A-9R

Operation is subject to the following two conditions: (1) this device may not cause interference, and (2) this device must accept any interference, including interference that may cause undesired operation of this device.

CAUTION

■ When inspecting or replacing tires

Observe the following precautions to prevent accidents. Failure to do so may cause damage to parts of the drive train, as well as dangerous handling characteristics, which may lead to an accident resulting in death or serious injury.

- Do not mix tires of different makes, models or tread patterns. Also, do not mix tires of remarkably different treadwear.
- Do not use tire sizes other than those recommended by Toyota.
- Do not mix differently constructed tires (radial, bias-belted or bias-ply tires).
- Do not mix summer, all season and winter tires.
- Do not use tires that have been used on another vehicle.
- Do not use tires if you do not know how they were used previously.

 **CAUTION**

■ **When initializing the tire pressure warning system**

Do not push the tire pressure warning reset switch without first adjusting the tire inflation pressure to the specified level. Otherwise, the tire pressure warning light may not come on even if the tire inflation pressure is low, or it may come on when the tire inflation pressure is actually normal.

 **NOTICE**

■ **Repairing or replacing tires, wheels, tire pressure warning valves, transmitters and tire valve caps**

● When removing or fitting the wheels, tires or the tire pressure warning valve and transmitter, contact your Toyota dealer as the tire pressure warning valve and transmitter may be damaged if not handled correctly.

● When replacing tire valve caps, do not use tire valve caps other than those specified. The cap may become stuck.

■ **To avoid damage to the tire pressure warning valves and transmitters**

When a tire is repaired with liquid sealants, the tire pressure warning valve and transmitter may not operate properly. If a liquid sealant is used, contact your Toyota dealer or other qualified service shop as soon as possible. Make sure to replace the tire pressure warning valve and transmitter when replacing the tire. (→P. 417)

■ **Driving on rough roads**

Take particular care when driving on roads with loose surfaces or potholes.

These conditions may cause losses in tire inflation pressure, reducing the cushioning ability of the tires. In addition driving on rough roads may cause damage to the tires themselves, as well as the vehicle's wheels and body.

■ **If tire inflation pressures become low while driving**

Do not continue driving, or your tires and/or wheels may be ruined.

4-3. Do-it-yourself maintenance

Tire inflation pressure

■ Tire inflation pressure

The recommended cold tire inflation pressure and tire size is displayed on the tire and loading information label. (→P. 528)

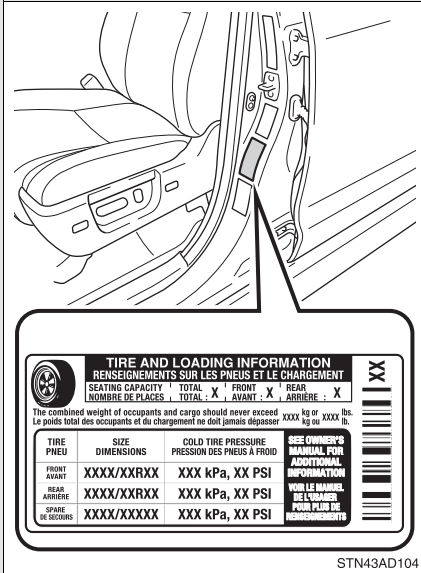

■ Inspection and adjustment procedure

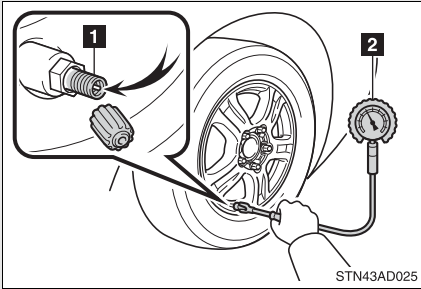

- 1 Tire valve
- 2 Tire pressure gauge

STEP 1 Remove the tire valve cap.

STEP 2 Press the tip of the tire pressure gauge onto the tire valve.

STEP 3 Read the pressure using the graduations of the gauge.

STEP 4 If the tire inflation pressure is not within the recommended levels, adjust inflate the tire.

If you add too much air, press the center of the valve to lower.

STEP 5 After completing the tire inflation pressure measurement and adjustment, apply soapy water to the valve and check for leakage.

STEP 6 Reinstall the tire valve cap.

■ Tire inflation pressure check interval

You should check tire pressure every two weeks, or at least once a month.

Do not forget to check the spare.

■ Effects of incorrect tire inflation pressure

Driving with incorrect tire inflation pressure may result in the following:

- Reduced fuel economy
- Reduced driving comfort and poor handling
- Reduced tire life due to wear
- Reduced safety
- Damage to the drive train

If a tire needs frequent refilling, have it checked by your Toyota dealer.

■ Instructions for checking tire inflation pressure

When checking tire inflation pressure, observe the following:

- Check only when the tires are cold.
If your vehicle has been parked for at least 3 hours and has not been driven for more than 1 mile or 1.5 km, you will get an accurate cold tire inflation pressure reading.
- Always use a tire pressure gauge.
It is difficult to judge if a tire is properly inflated based only on its appearance.
- It is normal for the tire inflation pressure to be higher after driving as heat is generated in the tire. Do not reduce tire inflation pressure after driving.
- Never exceed the vehicle capacity weight.
Passengers and luggage weight should be placed so that the vehicle is balanced.

 CAUTION

■ **Proper inflation is critical to save tire performance**

Keep your tires properly inflated.

If the tires are not properly inflated, the following conditions may occur which could lead to an accident resulting in death or serious injury:

- Excessive wear
- Uneven wear
- Poor handling
- Possibility of blowouts resulting from overheated tires
- Air leaking from between tire and wheel
- Wheel deformation and/or tire damage
- Greater possibility of tire damage while driving (due to road hazards, expansion joints, sharp edges in the road, etc.)

 NOTICE

■ **When inspecting and adjusting tire inflation pressure**

Be sure to reinstall the tire valve caps.

If a valve cap is not installed, dirt or moisture may get into the valve and cause an air leak, resulting in decreased tire inflation pressure.

Wheels

If a wheel is bent, cracked or heavily corroded, it should be replaced.

Otherwise, the tire may separate from the wheel or cause loss of handling control.

■ Wheel selection

When replacing wheels, care should be taken to ensure that they are equivalent to those removed in load capacity, diameter, rim width, and inset*.

Replacement wheels are available at your Toyota dealer.

*: Conventionally referred to as “offset”.

Toyota does not recommend using:

- Wheels of different sizes or types
- Used wheels
- Bent wheels that have been straightened

■ Wheel precautions

- Use only Toyota wheel nuts and wrench designed for use with your aluminum wheels.
- When rotating, repairing or changing your tires, check that the wheel nuts are still tight after driving 100 miles (160 km).
- Be careful not to damage the aluminum wheels when using tire chains.
- Use only Toyota genuine balance weights or equivalent and a plastic or rubber hammer when balancing your wheels.

■ When replacing wheels

The wheels of your Toyota are equipped with tire pressure warning valves and transmitters (except for spare tire) that allow the tire pressure warning system to provide advanced warning in the event of a loss in tire inflation pressure. Whenever wheels are replaced, the tire pressure warning valves and transmitters must be installed. (→P. 417)

⚠ CAUTION

■ When replacing wheels

- Do not use wheels that are a different size from those recommended in the Owner's Manual, as this may result in loss of handling control.
- Never use an inner tube in a leaking wheel which is designed for a tubeless tire. Doing so may result in an accident, causing death or serious injury.

■ When installing the wheel nuts

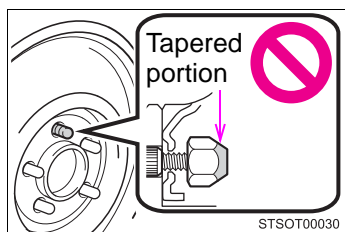

- Be sure to install the wheel nuts with the tapered end facing inward. Installing the nuts with the tapered end facing outward can cause wheel to break and eventually cause a wheel to come off while driving, which could lead to an accident resulting in death or serious injury.

- Never use oil or grease on the wheel bolts or wheel nuts. Oil and grease may cause the wheel nuts to be excessively tightened, leading to bolt or disc wheel damage. In addition, the oil or grease can cause the wheel nuts to loosen and the wheel may fall off, causing an accident and resulting in death or serious injury. Remove any oil or grease from the wheel bolts or wheel nuts.

**NOTICE****■ Replacing tire pressure warning valves and transmitters**

- Because tire repair or replacement may affect the tire pressure warning valves and transmitters, make sure to have tires serviced by your Toyota dealer or other qualified service shop. In addition, make sure to purchase your tire pressure warning valves and transmitters at your Toyota dealer.
- Ensure that only genuine Toyota wheels are used on your vehicle. Tire pressure warning valves and transmitters may not work properly with non-genuine wheels.

4-3. Do-it-yourself maintenance

Air conditioning filter

The air conditioning filter must be changed regularly to maintain air conditioning efficiency.

■ Replacement method

STEP 1 Turn the engine switch off.

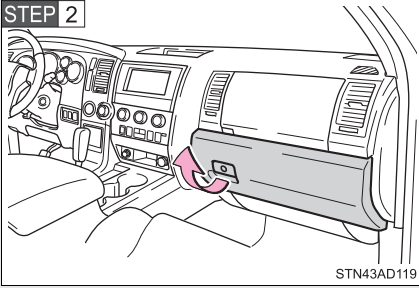

Open the glove box.

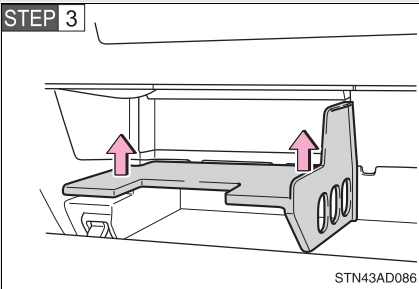

Remove the internal tray.

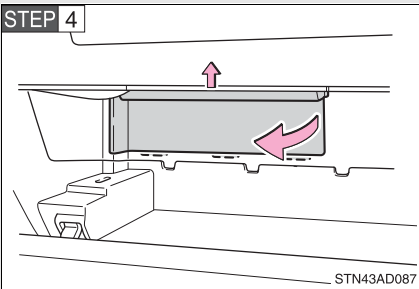

Remove the inside cover by sliding up while pulling toward you.

STEP 5

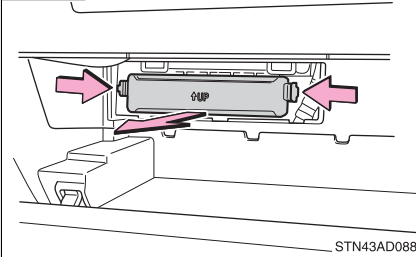

Remove the filter cover.

STEP 6

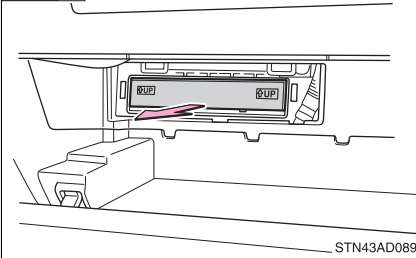

Pull the filter out of the filter outlet.

STEP 7

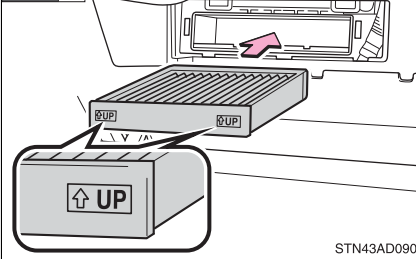

Remove the air conditioning filter and replace it with a new one.

The “↑UP” marks shown on the filter should be pointing up.

■ **Checking interval**

Inspect and replace the air conditioning filter according to the maintenance schedule. In dusty areas or areas with heavy traffic flow, early replacement may be required. (For scheduled maintenance information, please refer to the “Scheduled Maintenance Guide” or “Owner’s Manual Supplement”.)

■ **If air flow from the vents decreases dramatically**

The filter may be clogged. Check the filter and replace if necessary.



NOTICE

■ **When using the air conditioning system**

Make sure that a filter is always installed.

Using the air conditioning system without a filter may cause damage to the system.

Wireless remote control battery

Replace the battery with a new one if it is discharged.

■ **You will need the following items:**

Lithium battery CR2032

■ **Replacing the battery**

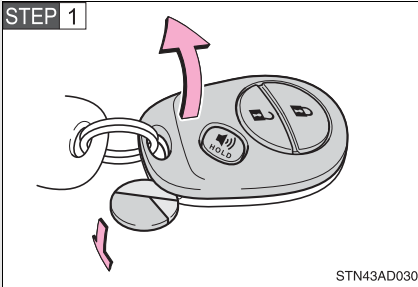

Remove the cover using a coin protected with tape etc.

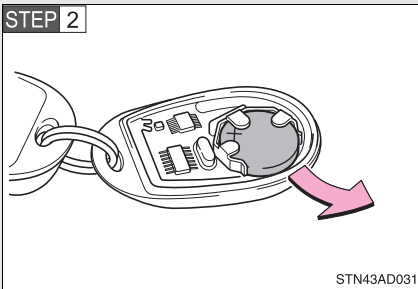

Remove the discharged transmitter battery.

Insert a new battery with the “+” terminal facing up.

■ **If the wireless remote control battery is discharged**

The following symptoms may occur.

- The wireless remote control will not function properly.
- The operational range is reduced.

■ **Use a CR2032 lithium battery**

- Batteries can be purchased at your Toyota dealer, jewelers, or camera stores.
- Replace only with the same or equivalent type recommended by your Toyota dealer.
- Dispose of used batteries according to the local laws.

 **CAUTION**

■ **Removed battery and other parts**

These parts are small and if swallowed by a child they can cause choking. Keep away from children. Failure to do so could result in death or serious injury.

 **NOTICE**

■ **For normal operation after replacing the battery**

Observe the following precautions to prevent accidents.

- Always work with dry hands.
Moisture may cause the battery to rust.
- Do not touch or move any other components inside the remote control.
- Do not bend either of the battery terminals.

4-3. Do-it-yourself maintenance

Checking and replacing fuses

If any of the electrical components do not operate, a fuse may have blown. If this happens, check and replace the fuses as necessary.

STEP 1 Turn the engine switch off.

STEP 2 The fuses are located in the following places. To check the fuses, follow the instructions below.

► Engine compartment

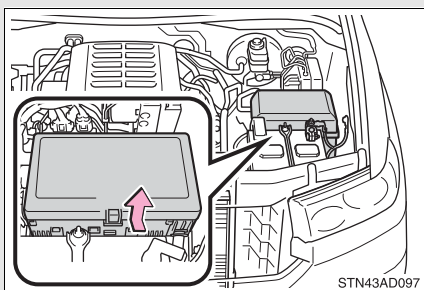

Push the tab in and lift the lid off.

► Under the instrument panel

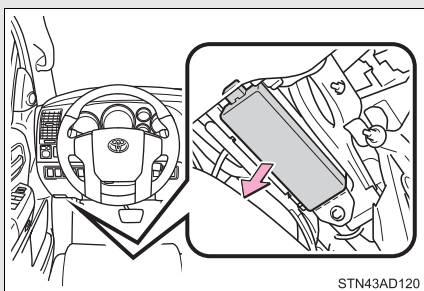

Remove the lid.

STEP 3 After a system failure, see “Fuse layout and amperage ratings” (→P. 438) for details about which fuse to check.

STEP 4

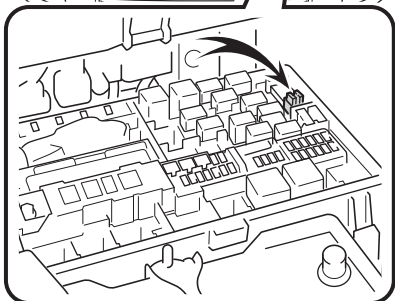
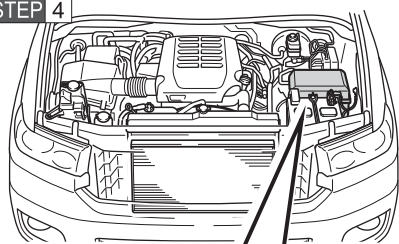

STN43AD127

Remove the fuse with the pull-out tool.

STEP 5 Check if the fuse has blown.

▶ Type A

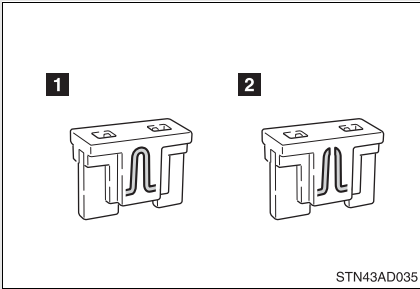
**1** Normal fuse**2** Blown fuse

Replace it with one of an appropriate amperage rating. The amperage rating can be found on the fuse box lid.

▶ Type B

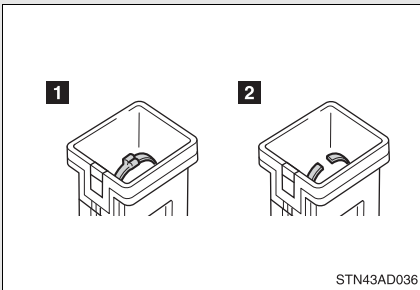
**1** Normal fuse**2** Blown fuse

Replace it with one of an appropriate amperage rating. The amperage rating can be found on the fuse box lid.

▶ Type C

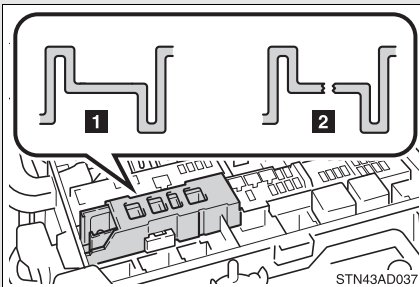
**1** Normal fuse**2** Blown fuse

Contact your Toyota dealer.

Fuse layout and amperage ratings

■ Engine compartment

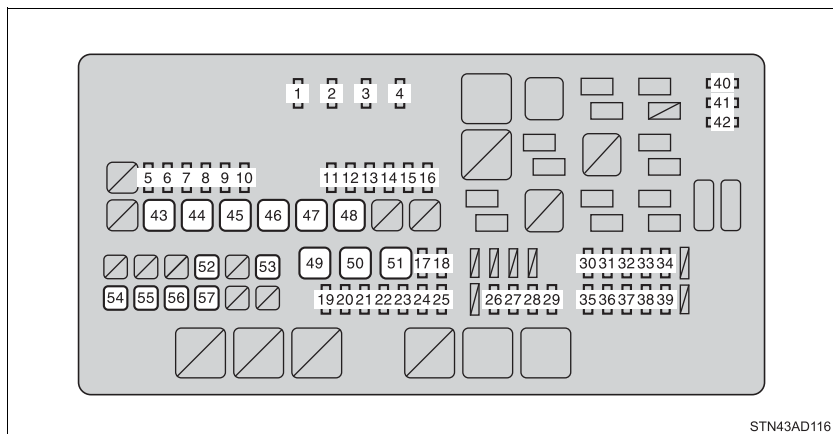

Fuse		Ampere	Circuit
1	A/F	15 A	Multiport fuel injection system/ sequential multiport fuel injection system
2	HORN	10 A	Horn
3	EFI NO.1	25 A	Multiport fuel injection system/ sequential multiport fuel injection system
4	IG2 MAIN	30 A	INJ, MET, IGN fuses
5	L2 RR2 SEAT	30 A	Power third seat
6	L1 RR2 SEAT	30 A	Power third seat
7	CDS FAN	25 A	Electric cooling fans
8	DEICER	20 A	Windshield wiper de-icer
9	TOW TAIL	30 A	Trailer lights (tail lights)
10	CDS FAN NO.2	25 A	Electric cooling fans
11	R2 RR2 SEAT	30 A	Power third seat
12	R1 RR2 SEAT	30 A	Power third seat

Fuse		Ampere	Circuit
13	POWER NO.4	25 A	Power windows
14	FOG	15 A	Front fog lights
15	STOP	15 A	Stop lights, high mounted stop-light, vehicle stability control system, anti-lock brake system, shift lock system, multiport fuel injection system/sequential multiport fuel injection system, towing converter
16	TOW BRK	30 A	Trailer brake controller
17	IMB	7.5 A	Multiport fuel injection system/sequential multiport fuel injection system
18	AM2	7.5 A	Starting system
19	TOWING	30 A	Towing converter
20	AI-HTR	10 A	Air injection pump heaters
21	ALT-S	5 A	Charging system
22	TURN-HAZ	15 A	Turn signal lights, emergency flashers, towing converter
23	F/PMP	25 A	Fuel pump
24	ETCS	10 A	Multiport fuel injection system/sequential multiport fuel injection system, electric throttle control system
25	MET-B	5 A	Gauges and meters
26	AMP	30 A	Audio system, rear view monitor, navigation system, rear seat entertainment system
27	RAD NO.1	15 A	Audio system, rear view monitor, navigation system, rear seat entertainment system

Fuse		Ampere	Circuit
28	ECU-B1	7.5 A	Multiplex communication system, Multiport fuel injection system/ sequential multiport fuel injection system, auto anti-glare inside rear view mirror, power front driver's seat, power tilt and power telescopic, power back door, gateway ECU
29	DOME	7.5 A	Interior lights, personal lights, vanity lights, engine switch light, foot light, door courtesy lights, accessory meter, power back door, power third seat
30	HEAD LH	15 A	Left-hand headlight (high beam)
31	HEAD LL	15 A	Left-hand headlight (low beam)
32	INJ	10 A	Multiport fuel injection system/ sequential multiport fuel injection system, ignition system
33	MET	7.5 A	Gauges and meters
34	IGN	10 A	SRS airbag system, multiport fuel injection system/sequential multiport fuel injection system, cruise control system, gateway ECU
35	HEAD RH	15 A	Right-hand headlight (high beam)
36	HEAD RL	15 A	Right-hand headlight (low beam)
37	EFI NO.2	10 A	Multiport fuel injection system/ sequential multiport fuel injection system, leak detection pump
38	DEF I/UP	5 A	No circuit

Fuse		Ampere	Circuit
39	AIR SUS NO.2	7.5 A	Electronically modulated air suspension system
40	SPARE	5 A	Spare fuse
41	SPARE	15 A	Spare fuse
42	SPARE	30 A	Spare fuse
43	AIR SUS	50 A	Electronically modulated air suspension system
44	PBD	30 A	Power back door
45	RR HTR	40 A	Air conditioning system
46	H-LP CLN	30 A	Headlight cleaner
47	DEFOG	40 A	Rear window defogger
48	SUB BATT	40 A	Trailer towing
49	ABS1	50 A	Anti-lock brake system, vehicle stability control system
50	ABS2	40 A	Anti-lock brake system, vehicle stability control system
51	ST	30 A	Starting system
52	HTR	50 A	Air conditioning system
53	LH-J/B	150 A	AM1, TAIL, PANEL, ACC, CIG, LH-IG, 4WD, ECU-IG NO.1, BK/UP LP, SEAT-HTR, A/C IG, ECU-IG NO.2, WSH, WIPER, OBD, A/C, TI&TE, FR P/SEAT RH, MIR, DR/LCK, FR P/SEAT LH, CARGO LP, PWR OUTLET, POWER NO.1 fuses
54	ALT	180 A*	LH-J/B, HTR, SUB BATT, TOW BRK, STOP, FOG, TOW TAIL, DEICER fuses
		140 A*	
55	A/PUMP NO.1	50 A	Multiport fuel injection system/ sequential multiport fuel injection system

Fuse		Ampere	Circuit
56	A/PUMP NO.2	50 A	Multiport fuel injection system/ sequential multiport fuel injection system
57	MAIN	40 A	HEAD LL, HEAD RL, HEAD LH, HEAD RH fuses

*: Replace the fuse with one of the same ampere rating as the original.

■ Under the instrument panel

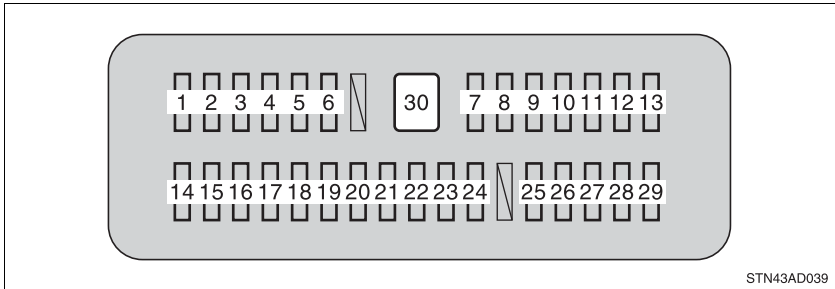

Fuse		Ampere	Circuit
1	INVERTER	15 A	Power outlet (120 V)
2	FR P/SEAT LH	30 A	Power front driver's seat
3	DR/LCK	25 A	Multiplex communication system
4	POWER No.5	30 A	Power back door
5	OBD	7.5 A	On-board diagnosis system
6	PWR OUTLET	15 A	Power outlets
7	AM1	7.5 A	Shift lock system, starting system, seat heaters
8	A/C	7.5 A	Air conditioning system
9	MIR	15 A	Outside rear view mirror control, outside rear view mirror heaters
10	POWER No.3	20 A	Power windows
11	FR P/SEAT RH	30 A	Power front passenger seat
12	TI&TE	15 A	Power tilt and power telescopic
13	S/ROOF	25 A	Electric moon roof
14	RR SEAT-HTR RH	10 A	Seat heaters

Fuse		Ampere	Circuit
15	ECU-IG No.1	7.5 A	Anti-lock brake system, vehicle stability control system, multiplex communication system, intuitive parking assist system, power front driver's seat, power tilt and power telescopic, shift lock, tire pressure warning system, accessory meter, trailer towing, power outlet, electric moon roof, power back door, head light cleaner, Blind Spot Monitor system, BSM main switch
16	AIR SUS IG	20 A	Electronically modulated air suspension system
17	LH-IG	7.5 A	Back-up lights, charging system, gauge and meters, turn signal lights, air conditioning system, seat heaters, rear window defogger
18	4WD	20 A	Four-wheel drive control system
19	RR SEAT-HTR LH	10 A	Seat heaters
20	WSH	20 A	Window washer
21	WIPER	30 A	Wiper and washer
22	ECU-IG No.2	7.5 A	Multiplex communication system, power steering, gateway ECU
23	TAIL	15 A	Tail lights, trailer lights (tail lights), parking lights
24	A/C IG	10 A	Air conditioning system
25	SEAT-HTR	20 A	Seat heater or Heated and ventilated seats

Fuse		Ampere	Circuit
26	PANEL	7.5 A	Instrument panel lights, glove box light, ashtray, accessory meter, audio system, rear view monitor, navigation system, rear seat entertainment system, gauges and meters, air conditioning system, seat heater or heated and ventilated switches, BSM main switch
27	ACC	7.5 A	Accessory meter, audio system, rear seat entertainment system, rear view monitor, navigation system, back-up lights, trailer lights (back-up lights), multiplex communication system, power outlet, outside rear view mirror
28	BK/UP LP	10 A	Back-up light, gauges and meters
29	CIG	15 A	Cigarette lighter
30	POWER No.1	30 A	Power windows, power back window

■ After a fuse is replaced

- If the lights do not turn on even after the fuse has been replaced, a bulb may need replacement. (→P. 447)
- If the replaced fuse blows again, have the vehicle inspected by your Toyota dealer.

■ If there is an overload in the circuits

The fuses are designed to blow, protecting the wiring harness from damage.

 CAUTION

■ **To prevent system breakdowns and vehicle fire**

Observe the following precautions.

Failing to do so may cause damage to the vehicle, and possibly a fire or injury.

- Never use a fuse of a higher amperage rating than indicated, or use any other object in place of a fuse.
- Always use a genuine Toyota fuse or equivalent.
Never replace a fuse with a wire, even as a temporary fix.
- Do not modify the fuse or the fuse box.

 NOTICE

■ **Before replacing fuses**

Have the cause of electrical overload determined and repaired by your Toyota dealer as soon as possible.

Light bulbs

You may replace the following bulbs yourself. The difficulty level of replacement varies depending on the bulb. If necessary bulb replacement seems difficult to perform, contact your Toyota dealer.

For more information about replacing other light bulbs, contact your Toyota dealer.

■ Prepare a replacement light bulb.

Check the wattage of the light bulb being replaced. (→P. 522)

■ Front bulb locations

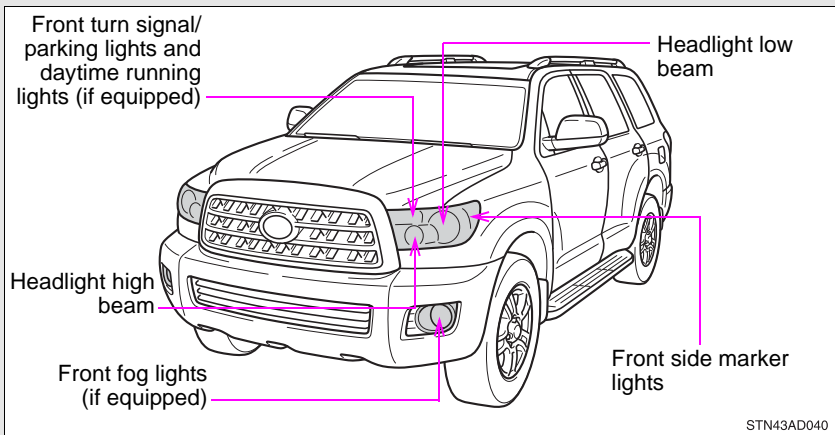

■ Rear bulb locations

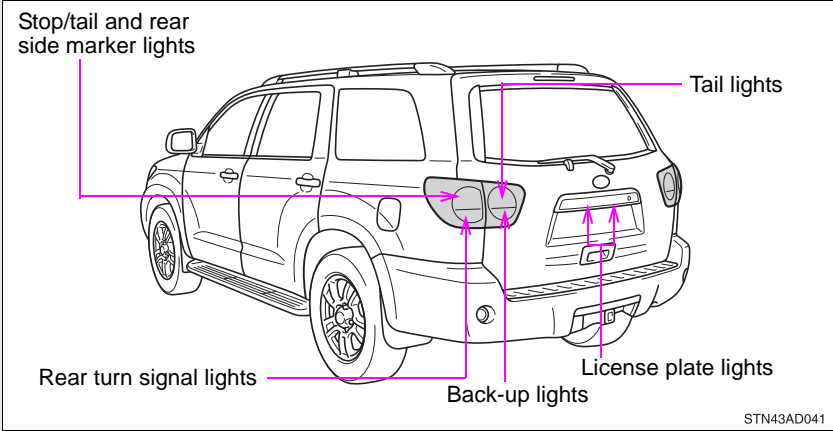

Replacing light bulbs

■ Headlight high beam

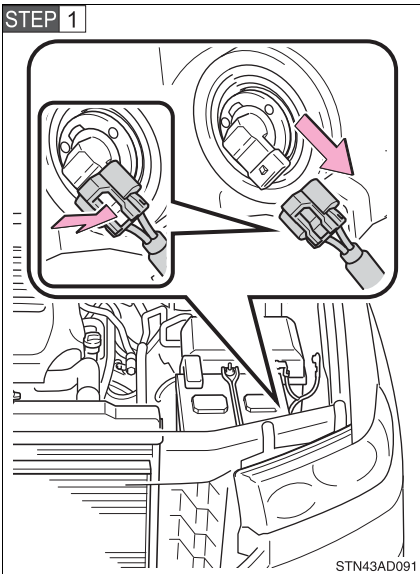

Unplug the connector while depressing the lock release.

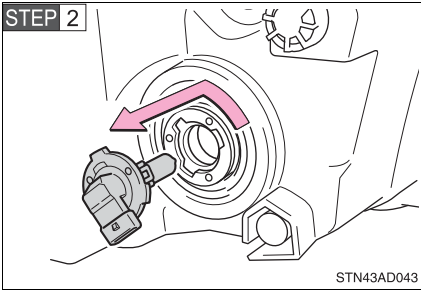

Turn the bulb base counterclockwise.

■ Headlight low beam

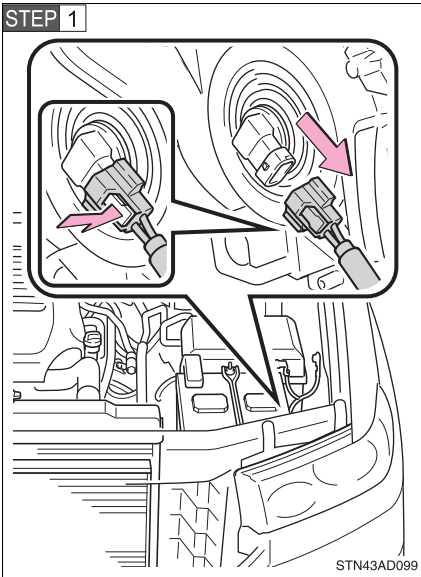

Unplug the connector while depressing the lock release.

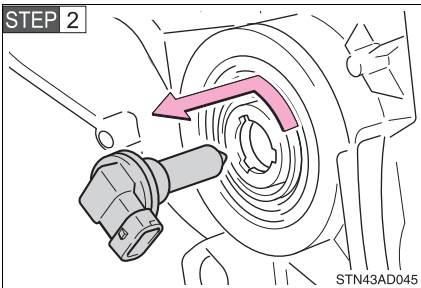

Turn the bulb base counterclockwise.

■ **Front turn signal/parking lights and daytime running lights (if equipped)**

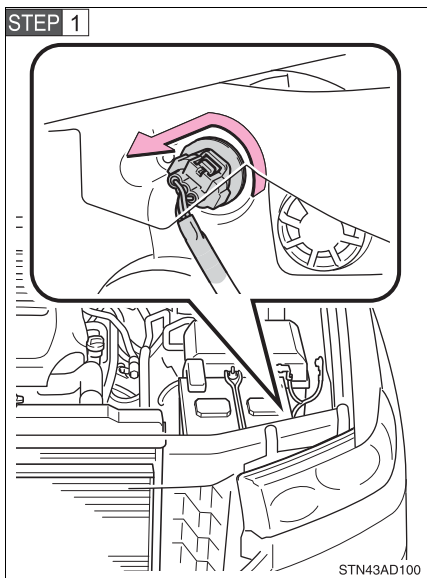

Turn the bulb base counterclockwise.

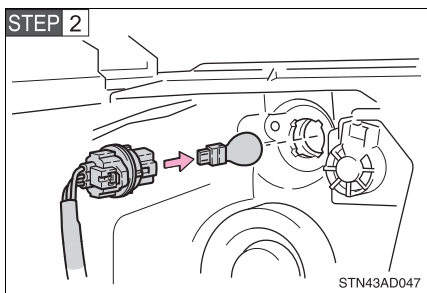

Remove the light bulb.

■ Front side marker lights

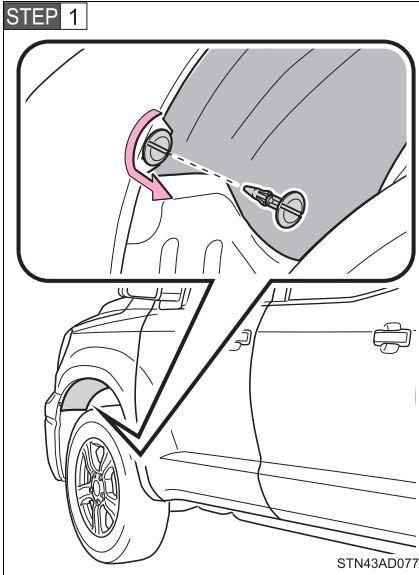

Remove the fender liner clip.

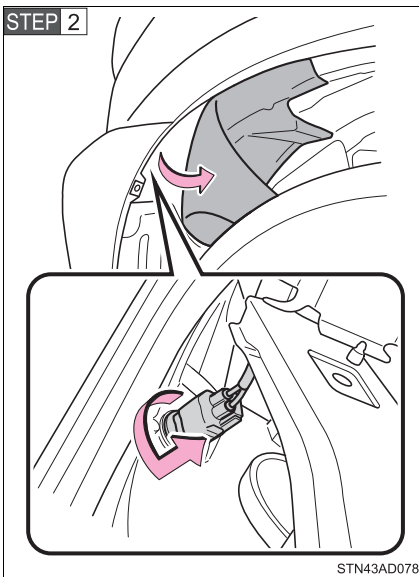

Partly remove the fender liner and turn the bulb base counter-clockwise.

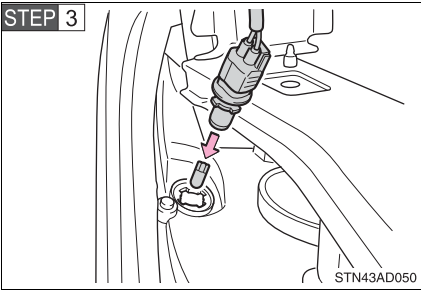

Remove the light bulb.

■ Front fog lights (if equipped)

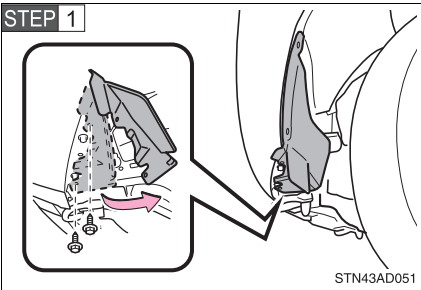

Remove the bolts and partly remove the fender liner.

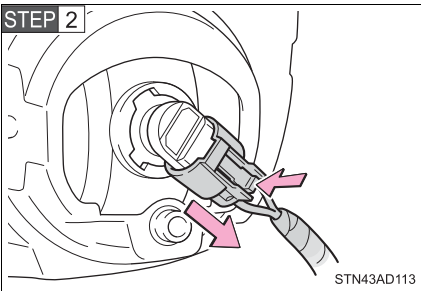

Unplug the connector while depressing the lock release.

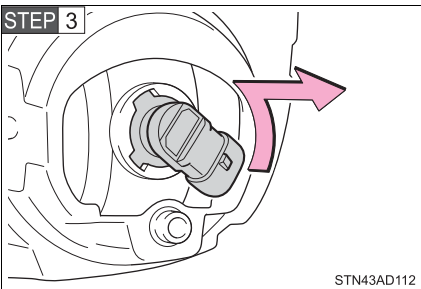

Turn the bulb counterclockwise.

■ Stop/tail and rear side marker lights, rear turn signal lights

▶ Right side

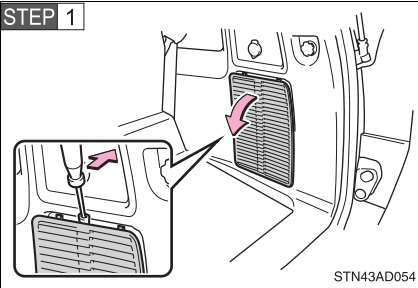

Open the back door and remove the cover.

To protect the cover, place a rag between the flathead screwdriver or equivalent and cover as shown in the illustrations.

▶ Left side (vehicles without speaker in the luggage)

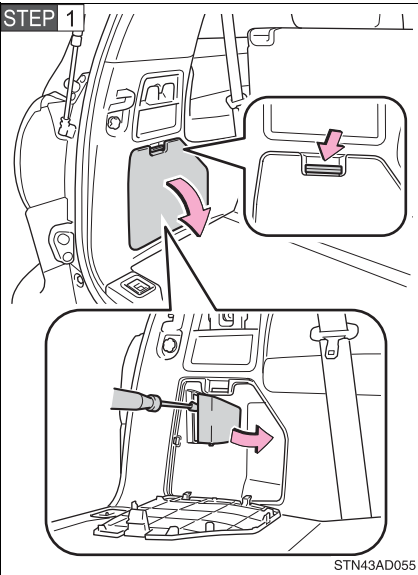

Open the back door and remove the covers.

To protect the cover, place a rag between the flathead screwdriver or equivalent and cover as shown in the illustrations.

► Left side (vehicles with speaker in the luggage)

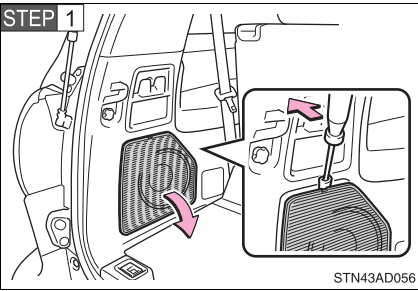

Open the back door and remove the cover.

To protect the cover, place a rag between the flathead screwdriver or equivalent and cover as shown in the illustrations.

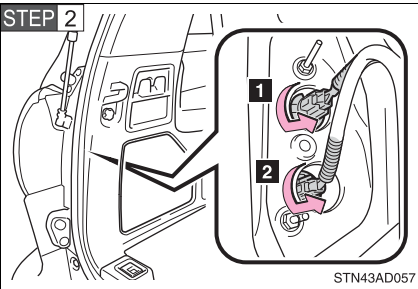

Turn the bulb bases counter-clockwise.

- 1 Stop/tail and rear side marker light
- 2 Rear turn signal light

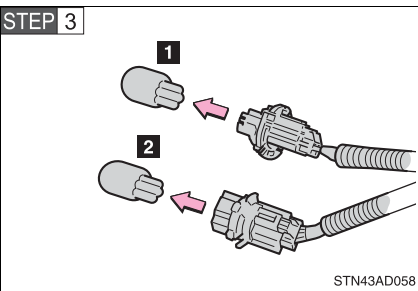

Remove the light bulb.

- 1 Stop/tail and rear side marker light
- 2 Rear turn signal light

► Tail lights, back-up lights

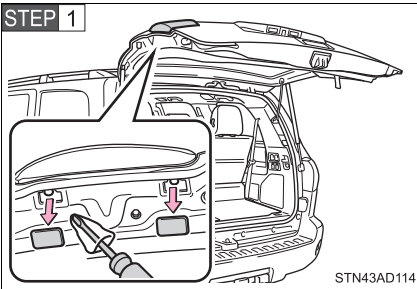

Remove the covers. (vehicles with power back door only)

To protect the cover, place a rag between the flathead screwdriver or equivalent and cover as shown in the illustrations.

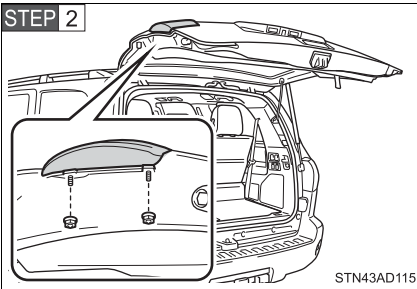

Remove the nuts.

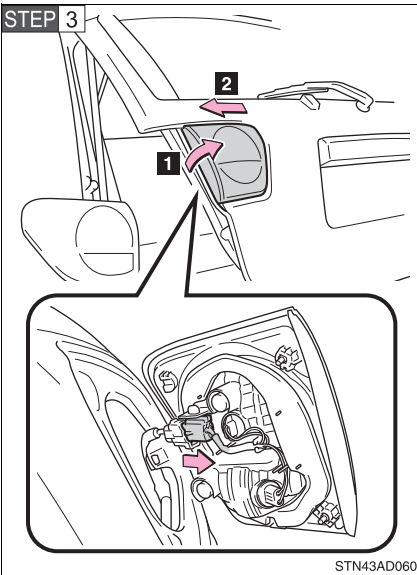

Remove the rear combination light assembly in the order shown in the illustration.

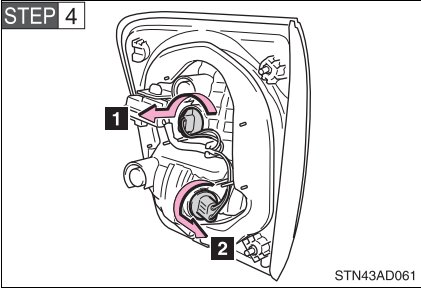

Turn the bulb base counterclockwise.

- 1** Tail light
- 2** Back-up light

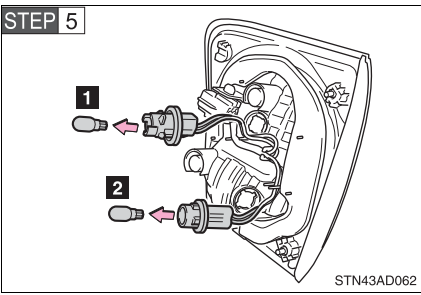

Remove the light bulb.

- 1** Tail light
- 2** Back-up light

■ License plate lights

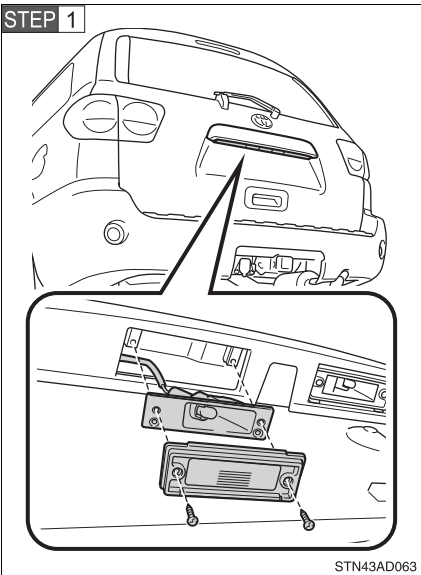

Remove the screws and light unit.

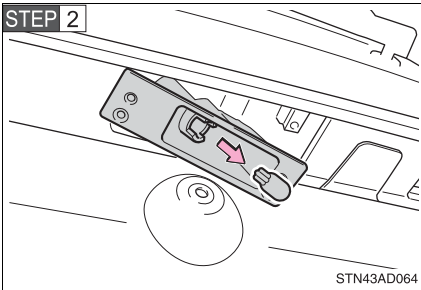

Remove the light bulb.

■ Lights other than the above

If any of the lights listed below has burnt out, have it replaced by your Toyota dealer.

- High mounted stoplight
- Outer foot light (if equipped)
- Side turn signal light (if equipped)

■ Condensation build-up on the inside of the lens

Temporary condensation build-up on the inside of the headlight lens does not indicate a malfunction.

Contact your Toyota dealer for more information in the following situations:

- Large drops of water are built up on the inside of the lens.
- Water has built up inside the headlight.

■ LED high mounted stoplight and side turn signal light

The high mounted stoplight and side turn signal light consist of a number of LEDs. If any of the LEDs burn out, take your vehicle to your Toyota dealer to have the light replaced.

■ Installing the fender liner clips

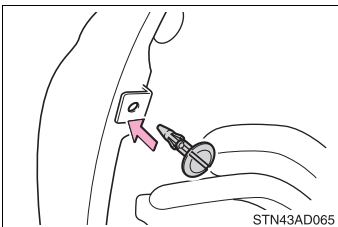

Insert the clip.

 CAUTION

■ **Replacing light bulbs**

- Turn off the headlights. Do not attempt to replace the bulb immediately after turning off the headlights.
The bulbs become very hot and may cause burns.
- Do not touch the glass portion of the light bulb with bare hands. When it is unavoidable to hold the glass portion, use and hold with a clean dry cloth to avoid getting moisture and oils on the bulb.
Also, if the bulb is scratched or dropped, it may blow out or crack.
- Fully install light bulbs and any parts used to secure them. Failing to do so may result in heat damage, fire, or water entering the headlight unit. This may damage the headlights or cause condensation to build up on the lens.

■ **To prevent damage or fire**

Make sure bulbs are fully seated and locked.

When trouble arises

5

5-1. Essential information

Emergency flashers	460
If your vehicle needs to be towed	461
If you think something is wrong	467
Fuel pump shut off system	468

5-2. Steps to take in an emergency

If a warning light turns on or a warning buzzer sounds... ..	469
If a warning message is displayed (vehicles with multi-information display)	480
If you have a flat tire.....	486
If the engine will not start.....	497
If the shift lever cannot be shifted from P.....	499
If you lose your keys	500
If the vehicle battery is discharged	501
If your vehicle overheats	504
If the vehicle becomes stuck	507
If your vehicle has to be stopped in an emergency	509

5-1. Essential information

Emergency flashers

Use the emergency flashers if the vehicle malfunctions or is involved in an accident.

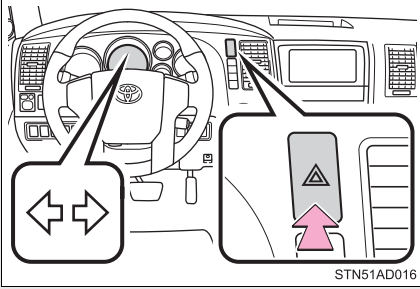

Press the switch to flash all the turn signal lights. To turn them off, press the switch once again.

NOTICE

■ To prevent battery discharge

Do not leave the emergency flashers on longer than necessary when the engine is not running.

5-1. Essential information

If your vehicle needs to be towed

If towing is necessary, we recommend having your vehicle towed by your Toyota dealer or commercial towing service, using a wheel-lift type truck or flatbed truck.

Use a safety chain system for all towing, and abide by all state/provincial and local laws.

Situations when it is necessary to contact dealers before towing

The following may indicate a problem with your transmission. Contact your Toyota dealer or commercial towing service before towing.

- The engine is running but the vehicle does not move.
- The vehicle makes an abnormal sound.

Towing with a sling-type truck

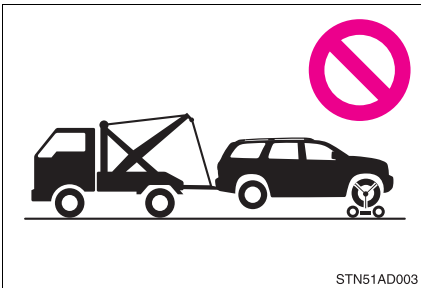

Do not tow with a sling-type truck to prevent body damage.

Towing with a wheel-lift type truck

► From the front

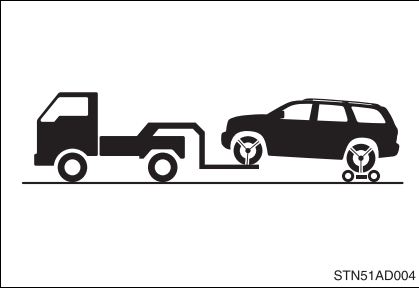

Use a towing dolly under the rear wheels.

► From the rear

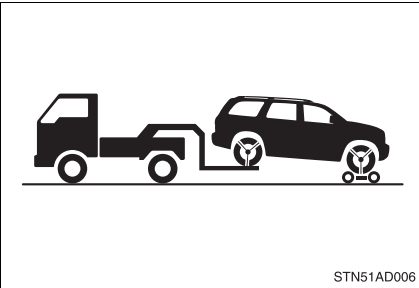

Use a towing dolly under the front wheels.

Using a flatbed truck

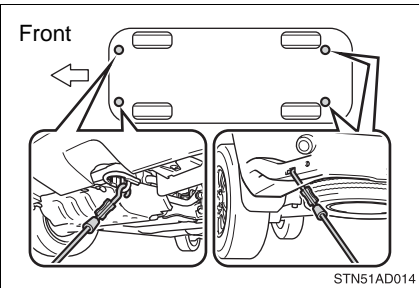

If your vehicle is transported by a flatbed truck, it should be tied down at the locations shown in the illustration.

► Vehicles without electronically modulated air suspension

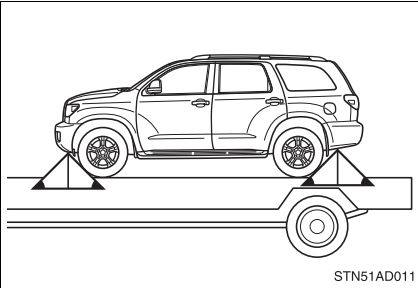

If you use chains or cables to tie down your vehicle, the angles shaded in black must be 45°.

Do not overly tighten the tie downs or the vehicle may be damaged.

► Vehicles with electronically modulated air suspension

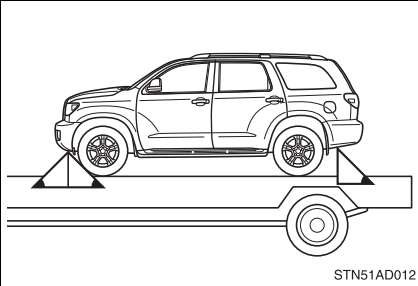

If you use chains or cables to tie down your vehicle, the angles shaded in black must be 45°.

Do not overly tighten the tie downs or the vehicle may be damaged.

Emergency towing

If a tow truck is not available in an emergency, your vehicle may be temporarily towed using cables or chains secured to the emergency towing hooks. This should only be attempted on hard, surfaced roads for at most 50 miles (80 km) at under 18mph (30 km/h).

A driver must be in the vehicle to steer and operate the brakes. The vehicle's wheels, drive train, axles, steering and brakes must be in good condition.

Emergency towing procedure

► TYPE A

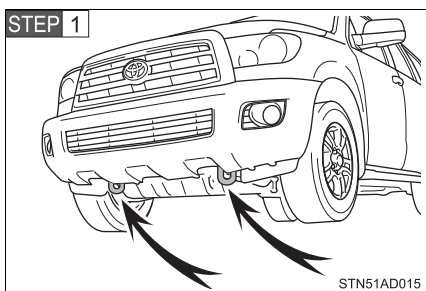

Securely attach cables or chains to the towing hooks.

Take care not to damage the vehicle body.

► TYPE B

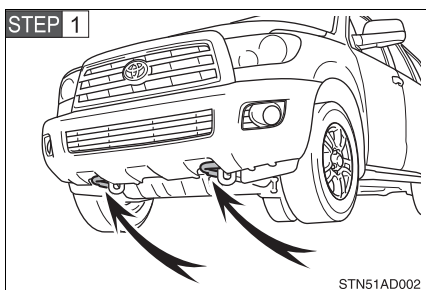

Securely attach cables or chains to the towing hooks.

Take care not to damage the vehicle body.

STEP 2 Enter the vehicle being towed and start the engine.

If the engine does not start, turn the engine switch to the “ON” position.

STEP 3 4WD models: Put the front-wheel drive control switch in “2WD”.

STEP 4 Shift the shift lever to N and release the parking brake.

When the shift lever cannot be shifted: (→P. 499)

■ While towing

If the engine is not running, the power assist for the brakes and steering will not function, making steering and braking more difficult.

⚠ CAUTION

Observe the following precautions.
Failure to do so may result in death or serious injury.

■ When towing the vehicle

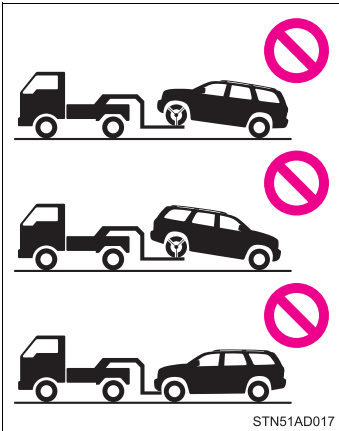

2WD models: Be sure to transport the vehicle with all four wheels raised off the ground. If the vehicle is towed with the tires contacting the ground, the drivetrain and related parts may be damaged or an accident may occur due to a change in direction of the vehicle.

4WD models: Be sure to transport the vehicle with all four wheels raised off the ground. If the vehicle is towed with the tires contacting the ground, the drivetrain or related parts may be damaged, the vehicle may fly off the truck.

■ While towing

- When towing using cables or chains, avoid sudden starts, etc. which place excessive stress on the towing hooks, cables or chains. The towing hooks, cables or chains may become damaged, broken debris may hit people, and cause serious damage.
- Do not turn the engine switch to the LOCK position.
There is a possibility that the steering wheel is locked and cannot be operated.



NOTICE

■ **To prevent damage to the vehicle when towing using a wheel-lift type truck**

- Do not tow the vehicle from the rear when the engine switch is in the LOCK position or the key is removed.

The steering lock mechanism is not strong enough to hold the front wheels straight.

- When raising the vehicle, ensure adequate ground clearance for towing at the opposite end of the raised vehicle. Without adequate clearance, the vehicle could be damaged while being towed.

■ **To prevent damage to the vehicle when towing with a sling-type truck**

Do not tow with a sling-type truck, either from the front or rear.

■ **To prevent damage to the vehicle during emergency towing**

Do not secure cables or chains to the suspension components.

If you notice any of the following symptoms, your vehicle probably needs adjustment or repair. Contact your Toyota dealer as soon as possible.

■ **Visible symptoms**

- Fluid leaks under the vehicle
(Water dripping from the air conditioning after use is normal.)
- Flat-looking tires or uneven tire wear
- Engine coolant temperature gauge needle continually points higher or lower than normal
- Voltmeter continually points higher or lower than normal
- Engine oil pressure gauge continually points higher or lower than normal
- Automatic transmission fluid temperature gauge needle continually points higher or lower than normal (if equipped)

■ **Audible symptoms**

- Changes in exhaust sound
- Excessive tire squeal when cornering
- Strange noises related to the suspension system
- Pinging or other noises related to the engine

■ **Operational symptoms**

- Engine misfire, stumbling or running rough
- Appreciable loss of power
- Vehicle pulls heavily to one side when braking
- Vehicle pulls heavily to one side when driving on a level road
- Loss of brake effectiveness, spongy feeling, pedal almost touches the floor

Fuel pump shut off system

To minimize the risk of fuel leakage when the engine stalls or an air-bag inflates upon collision, the fuel pump shut off system stops supplying fuel to the engine.

Follow the procedure below to restart the engine after the system is activated.

STEP 1 Turn the engine switch to the ACC or LOCK position.

STEP 2 Restart the engine.



NOTICE

■ Before starting the engine

Inspect the ground under the vehicle.

If you find that fuel has leaked onto the ground, the fuel system has been damaged and is in need of repair. Do not restart the engine.



5-2. Steps to take in an emergency

If a warning light turns on or a warning buzzer sounds...

Calmly perform the following actions if any of the warning lights turn on or flash. If a light turns on or flashes, but then turns off, this does not necessarily indicate a malfunction in the system.

Stop the vehicle immediately. Continuing to drive the vehicle may be dangerous.

The following warning indicates a possible problem in the brake system. Immediately stop the vehicle in a safe place and contact your Toyota dealer.

Warning light	Warning light/Details
 (U.S.A.)	Brake system warning light (warning buzzer)* <ul style="list-style-type: none">• Low brake fluid• Malfunction in the brake system This light also comes on when the parking brake is not released. If the light turns off after the parking brake is fully released, the system is operating normally.
 (Canada)	

*: Parking brake engaged warning buzzer:

The buzzer sounds to indicate that parking brake is still engaged (with the vehicle having reached a speed of 3 mph [5 km/h])







Stop the vehicle immediately.

The following warnings indicate the possibility of damage to the vehicle that may lead to an accident. Immediately stop the vehicle in a safe place and contact your Toyota dealer.

Warning light	Warning light/Details
	Charging system warning light Indicates a malfunction in the vehicle's charging system.



Have the vehicle inspected immediately.

Failing to investigate the cause of the following warnings may lead to the system operating abnormally and possibly cause an accident. Have the vehicle inspected by your Toyota dealer immediately.



Warning light	Warning light/Details
 (U.S.A.)  (Canada)	<p>Malfunction indicator lamp Indicates a malfunction in:</p> <ul style="list-style-type: none"> • The electronic engine control system; • The electronic throttle control system; • The electronic automatic transmission control system; or • The emission control system.
	<p>SRS warning light Indicates a malfunction in:</p> <ul style="list-style-type: none"> • The SRS airbag system; • The front passenger occupant classification system; or • The seat belt pretensioner system.
 (U.S.A.)  (Canada)	<p>ABS warning light Indicates a malfunction in:</p> <ul style="list-style-type: none"> • The ABS; or • The brake assist system.
	<p>Slip indicator Indicates a malfunction in:</p> <ul style="list-style-type: none"> • The VSC; • The TRAC; or • The AUTO LSD system.
	<p>Power steering warning light Indicates a malfunction in the variable flow control power steering system.</p>

Follow the correction procedures.

After taking the specified steps to correct the suspected problem, check that the warning light turns off.

Warning light	Warning light/Details	Correction procedure
	<p>Open door warning light (warning buzzer)*¹ Indicates that a door or back door is not fully closed.</p>	<p>Check that all doors are closed.</p>
 (On the instrument cluster)	<p>Driver's seat belt reminder light (warning buzzer)*² Warns the driver to fasten his/her seat belt.</p>	<p>Fasten the seat belt.</p>
 (On the center panel)	<p>Front passenger's seat belt reminder light (warning buzzer)*³ Warns the front passenger to fasten his/her seat belt.</p>	<p>Fasten the seat belt.</p>

Warning light	Warning light/Details	Correction procedure
<p style="text-align: right;">*4</p> <div style="border: 1px solid black; padding: 5px; width: fit-content; margin: 0 auto;"> <p>A/T OIL TEMP</p> </div>	<p>Automatic transmission fluid temperature warning light</p> <p>When the light comes on: Indicates that the automatic transmission fluid temperature is too high.</p> <p>When the light flashes: Indicates a malfunction in the automatic transmission system.</p>	<p>Immediately stop the vehicle in a safe place, shift the shift lever to P and wait until the light goes off.</p> <p>If the light goes off, you may start the vehicle again. If the light does not go off, contact your Toyota dealer.</p> <p>Have the system checked by your Toyota dealer.</p>
<div style="border: 1px solid black; padding: 5px; width: fit-content; margin: 0 auto;">  </div>	<p>Tire pressure warning light</p> <p>When the light comes on: Low tire inflation pressure such as</p> <ul style="list-style-type: none"> • Natural causes (→P. 475) • Flat tire (→P. 486) <p>When the light comes on after blinking for 1 minute: Malfunction in the tire pressure warning system (→P. 476)</p>	<p>Adjust the tire inflation pressure to the specified level.</p> <p>The light will turn off after a few minutes. In case the light does not turn off even if the tire inflation pressure is adjusted, have the system checked by your Toyota dealer.</p> <p>Have the system checked by your Toyota dealer.</p>

Warning light	Warning light/Details	Correction procedure
	<p>Low fuel level warning light Low level of fuel.</p>	<p>Refuel the vehicle.</p>
<p>^{*4}</p> 	<p>Low washer fluid warning light Low level of washer fluid.</p>	<p>Fill the tank.</p>
<p>^{*4}</p>  <p>(U.S.A.)</p>	<p>Maintenance required reminder light Indicates that maintenance is required according to the driven distance on the maintenance schedule. ^{*6}</p>	
	<p>Illuminates for about 3 seconds and then flashes for about 15 seconds approximately 4500 miles (7200 km) after the reminder light has been reset.</p>	<p>If necessary, perform maintenance.</p>
	<p>Comes on and remains on if the distance driven exceeds 5000 miles (8000 km) after the reminder light has been reset. (The indicator will not work properly unless the reminder light has been reset.)</p>	<p>Perform the necessary maintenance. Please reset the reminder light after the maintenance is performed. (→P. 389)</p>

Warning light	Warning light/Details	Correction procedure
	<p>Master warning light A buzzer sounds and the warning light comes on and flashes to indicate that the master warning system has detected a malfunction.</p>	<p>→P. 480</p>

*1: Open door warning buzzer:

The buzzer sounds to indicate that any door is opened (with the vehicle having reached a speed of 3 mph [5 km/h])

*2: Driver's seat belt reminder:

The driver's seat belt reminder sounds to alert the driver that his or her seat belt is not fastened. Once the engine switch is turned to the ON or START position, the buzzer sounds for 6 seconds. If the vehicle has reached a speed of at least 12 mph (20 km/h), the buzzer sounds intermittently for 10 seconds. Then, if the seat belt is still unfastened, the buzzer will sound in a different tone for 20 more seconds.

*3: Front passenger's seat belt reminder:

The front passenger's seat belt reminder sounds to alert the front passenger that his or her seat belt is not fastened. The buzzer sounds intermittently for 10 seconds after the vehicle has reached a speed of at least 12 mph (20 km/h). Then, if the seat belt is still unfastened, the buzzer will sound in a different tone for 20 more seconds.

*4: Vehicles without multi-information display

*5: Vehicles with multi-information display

*6: Refer to the separate "Scheduled Maintenance Guide" or "Owner's Manual Supplement" for the maintenance interval applicable to your vehicle.

■ Four-wheel drive system warning buzzer

The buzzer indicated that the transfer mode is not selected correctly.

■ Key reminder buzzer

The buzzer indicates that the key has not been removed (with the engine switch in the ACC or LOCK position and the driver's door opened).

■ Open moon roof reminder buzzer

The buzzer indicate that the moon roof is still opened (with the engine switch in the ACC or LOCK position and the driver's door opened).

■ If the malfunction indicator lamp comes on while driving

First check the following:

- Is your vehicle low on gas?
If it is, refuel the vehicle immediately.
- Is the fuel tank cap loose?
If it is, tighten it securely.

The light will go off after taking several driving trips.

If the light does not go off even after several trips, contact your Toyota dealer as soon as possible.

■ Front passenger detection sensor and passenger seat belt reminder

If luggage or other load is placed on the front passenger seat, depending on its weight, the reminder light to flash and buzzer to sound.

■ When the tire pressure warning light comes on

Check the tire inflation pressure and adjust to the appropriate level. Pushing the tire pressure warning reset switch does not turn off the tire pressure warning light.

■ The tire pressure warning light may turn on due to natural causes

The tire pressure warning light may turn on due to natural causes such as natural air leaks or tire inflation pressure changes caused by temperature. In this case, adjusting the tire inflation pressure will turn off the warning light (after several minutes).

■ When a tire is replaced with a temporary spare tire

The temporary spare tire is not equipped with the tire pressure warning valve and transmitter. If a tire goes flat, the tire pressure warning light will not turn off even though the flat tire is replaced with the temporary spare tire. Replace the temporary spare tire with the repaired tire and adjust the proper tire inflation pressure. The tire pressure warning light will turn off after several minutes.

■ If the tire pressure warning system is inoperative

The tire pressure warning system will be disabled in the following conditions:

(When the condition becomes normal, the system will work properly.)

- If tires not equipped with tire pressure warning valves and transmitters are used.
- If the ID code on the tire pressure warning valves and transmitters is not registered in the tire pressure warning computer.
- If the tire inflation pressure is 73 psi (500 kPa, 5.1 kgf/cm² or bar) or higher.

The tire pressure warning system may be disabled in the following conditions:

(When the condition becomes normal, the system will work properly.)

- If electronic devices or facilities using similar radio wave frequencies are nearby.
- If a radio set at similar frequencies is in use in the vehicle.
- If a window tint that affects the radio wave signals is installed.
- If there is a lot of snow or ice on the vehicle, in particular around the wheels or wheel housings.
- If non-genuine Toyota wheels are used. (Even if you use Toyota wheels, the tire pressure warning system may not work properly with some types of tires.)
- If tire chains are used.

■ **If the tire pressure warning light frequently comes on after blinking for 1 minute**

If the tire pressure warning light frequently comes on after blinking for 1 minute when the engine switch is turned to the ON position, have it checked by your Toyota dealer.

■ **Customization that can be configured at Toyota dealer**

The vehicle speed linked seat belt reminder buzzer can be disabled. (Customizable features →P. 539)

 **CAUTION**

■ **If the tire pressure warning light comes on**

Be sure to observe the following precautions. Failure to do so could cause loss of vehicle control and result in death or serious injury.

- Stop your vehicle in a safe place as soon as possible. Adjust the tire inflation pressure immediately.
- If the tire pressure warning light comes on even after tire inflation pressure adjustment, it is probable that you have a flat tire. Check the tires. If the tire is flat, change to the spare tire and have the flat tire repaired by the nearest Toyota dealer.
- Avoid abrupt maneuvering and braking. If the vehicle tires deteriorate, you could lose control of the steering wheel or the brakes.

■ **If a blowout or sudden air leakage should occur**

The tire pressure warning system may not activate immediately.

 CAUTION

■ **Maintenance of the tire**

Each tire, including the spare (if provided), should be checked monthly when cold and inflated to the inflation pressure recommended by the vehicle manufacturer on the vehicle placard or tire inflation pressure label (tire and load information label). (If your vehicle has tires of a different size than the size indicated on the vehicle placard or tire inflation pressure label [tire and load information label], you should determine the proper tire inflation pressure for those tires.)

As an added safety feature, your vehicle has been equipped with a tire pressure monitoring system (TPMS-tire pressure warning system) that illuminates a low tire pressure telltale (tire pressure warning light) when one or more of your tires is significantly under-inflated. Accordingly, when the low tire pressure telltale (tire pressure warning light) illuminates, you should stop and check your tires as soon as possible, and inflate them to the proper pressure. Driving on a significantly under-inflated tire causes the tire to overheat and can lead to tire failure. Under-inflation also reduces fuel efficiency and tire tread life, and may affect the vehicle's handling and stopping ability.

Please note that the TPMS (tire pressure warning system) is not a substitute for proper tire maintenance, and it is the driver's responsibility to maintain correct tire pressure, even if under-inflation has not reached the level to trigger illumination of the TPMS low tire pressure telltale (tire pressure warning light).

Your vehicle has also been equipped with a TPMS (tire pressure warning system) malfunction indicator to indicate when the system is not operating properly. The TPMS (tire pressure warning system) malfunction indicator is combined with the low tire pressure telltale (tire pressure warning light). When the system detects a malfunction, the telltale will flash for approximately one minute and then remain continuously illuminated. This sequence will continue upon subsequent vehicle start-ups as long as the malfunction exists. When the malfunction indicator is illuminated, the system may not be able to detect or signal low tire pressure as intended.

 CAUTION

TPMS (tire pressure warning system) malfunctions may occur for a variety of reasons, including the installation of replacement or alternate tires or wheels on the vehicle that prevent the TPMS (tire pressure warning system) from functioning properly. Always check the TPMS (tire pressure warning system) malfunction telltale after replacing one or more tires or wheels on your vehicle to ensure that the replacement or alternate tires and wheels allow the TPMS (tire pressure warning system) to continue to function properly.

 NOTICE

■ **To ensure the tire pressure warning system operates properly**

When a tire of a different specification or maker is installed, the tire pressure warning system may not operate properly.

5-2. Steps to take in an emergency

If a warning message is displayed (vehicles with multi-information display)

If a warning is shown on the multi-information display, stay calm and perform the following actions:

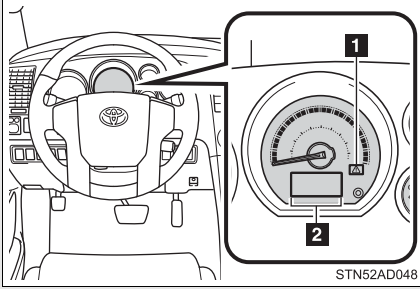

1 Master warning light



The master warning light also comes on or flashes in order to indicate that a message is currently being displayed on the multi-information display.

2 Multi-information display

If any of the warning lights turns on again after performing the following actions, contact your Toyota dealer.



Stop the vehicle immediately.

The following warnings indicate the possibility of damage to the vehicle that may lead to an accident. Immediately stop the vehicle in a safe place and contact your Toyota dealer.









Warning message	Details
  (Flashing)	Indicates that the engine coolant temperature is too high A buzzer also sounds.

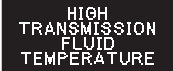

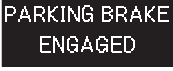

Follow the correction procedures.

After taking the specified steps to correct the suspected problem, check that the warning message goes off.

Warning message	Details	Correction procedure
<div data-bbox="142 472 314 540" style="background-color: black; color: white; padding: 5px; text-align: center;">DRIVER'S DOOR OPEN</div> <div data-bbox="142 586 314 654" style="background-color: black; color: white; padding: 5px; text-align: center;">FRONT PASSENGER'S DOOR OPEN</div> <div data-bbox="142 699 314 768" style="background-color: black; color: white; padding: 5px; text-align: center;">LEFT REAR DOOR OPEN</div> <div data-bbox="142 813 314 881" style="background-color: black; color: white; padding: 5px; text-align: center;">RIGHT REAR DOOR OPEN</div>	<p>Indicates that one or more of the doors is not fully closed.</p> <p>The system also indicates which doors are not fully closed.</p> <div data-bbox="391 634 476 695" style="border: 1px solid black; padding: 5px; display: inline-block; text-align: center;">  </div> <p>flashes and a buzzer sounds to indicate that one or more of the doors is not fully closed (with the vehicle having reached a speed of 3 mph [5 km/h]). Open door warning light also comes on.</p>	<p>Make sure that all of the doors are closed.</p>
<div data-bbox="142 1057 314 1125" style="background-color: black; color: white; padding: 5px; text-align: center;">BACK DOOR OPEN</div>	<p>Indicates that the back door is not fully closed.</p> <div data-bbox="391 1040 476 1101" style="border: 1px solid black; padding: 5px; display: inline-block; text-align: center;">  </div> <p>flashes and a buzzer sounds to indicate that the back door is not fully closed (with the vehicle having reached a speed of 3 mph [5 km/h]).</p>	<p>Closed the back door.</p>

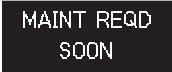



5-2. Steps to take in an emergency



Warning message	Details	Correction procedure
 	<p>Indicates that the automatic transmission fluid temperature is too high A buzzer also sounds.</p>	<p>Immediately stop the vehicle in a safe place, shift the shift lever to P and wait until the light goes off. If the light goes off, you may start the vehicle again. If the light does not go off, contact your Toyota dealer.</p>
 	<p>Indicates a malfunction in the automatic transmission system A buzzer also sounds.</p>	<p>Have the system checked by your Toyota dealer.</p>
  (Flashing)	<p>Indicates that the parking brake is still engaged with the vehicle having reached a speed of more than 3 mph (5 km/h). A buzzer also sounds intermittently.</p>	<p>Release the parking brake.</p>
 	<p>Indicates that the washer fluid level is low. A buzzer also sounds.</p>	<p>Add washer fluid.</p>

Warning message	Details	Correction procedure
  (U.S.A. only)	<p>Indicates that all maintenance according to the driven distance on the maintenance schedule* should be performed soon.</p> <p>Comes on approximately 4500 miles (7200 km) after the message has been reset.</p>	<p>If necessary, perform maintenance.</p>
  (U.S.A. only)	<p>Indicates that all maintenance is required to correspond to the driven distance on the maintenance schedule*.</p> <p>Comes on approximately 5000 miles (8000 km) after the message has been reset. (The indicator will not work properly unless the message has been reset.)</p>	<p>Perform the necessary maintenance. Please reset the message after the maintenance is performed. (→P. 389)</p>
	<p>Indicates that the fuel level is low.</p> <p>A buzzer also sounds and the low fuel level warning light comes on.</p>	<p>Fill up the tank as soon as possible.</p>

*: Refer to the separate “Scheduled Maintenance Guide” or “Owner’s Manual Supplement” for the maintenance interval applicable to your vehicle.

5-2. Steps to take in an emergency

Warning message	Details	Correction procedure
<p>CLEAN RADAR SENSOR</p> <p>(if equipped)</p> 	<p>Indicates that the laser radar sensor is dirty or covered with ice.</p> <p>A buzzer also sounds.</p>	<p>Clean the sensor.</p>
<p>CRUISE NOT AVAILABLE</p> <p>(if equipped)</p> 	<p>Indicates that the dynamic laser cruise control system is unable to judge vehicle-to-vehicle distance.</p> <p>A buzzer also sounds.</p>	<p>If the windshield wipers are on, turn them off or set them to either the intermittent.</p>
 <p>SET 60 mph</p> <p>(Flashing)</p> <p>(if equipped)</p>	<p>Indicates that your vehicle is nearing the vehicle ahead (in vehicle-to-vehicle distance control mode).</p>	<p>Slow the vehicle by applying the brakes.</p>
<p>CHECK CRUISE SYSTEM</p> <p>(if equipped)</p>  <p>CRUISE (Flashing)</p>	<p>Indicates that the dynamic laser cruise control system is malfunction.</p> <p>A buzzer also sounds.</p>	<p>Press the ON-OFF button once to deactivate the system, and then press the button again to reactivate the system.</p>

Warning message	Details	Correction procedure
<div data-bbox="142 321 316 391" style="background-color: black; color: white; padding: 5px; text-align: center;">BSM NOT AVAILABLE</div> <p data-bbox="155 415 298 443">(if equipped)</p> <div data-bbox="119 451 213 513" style="border: 1px solid black; padding: 5px; text-align: center;">  </div>	<p data-bbox="373 256 678 347">Indicates that the Blind Spot Monitor sensor is dirty or covered with ice.</p> <p data-bbox="389 355 642 383">A buzzer also sounds.</p> <hr/> <p data-bbox="373 404 687 526">Indicates that the Blind Spot Monitor sensor has been exposed to very high or low temperatures.</p> <p data-bbox="389 534 642 561">A buzzer also sounds.</p>	<p data-bbox="710 305 910 332">Clean the sensor.</p> <hr/> <p data-bbox="710 451 969 511">Wait for sensor to cool down or warm up.</p>
<div data-bbox="142 597 316 667" style="background-color: black; color: white; padding: 5px; text-align: center;">CHECK BSM SYSTEM</div> <p data-bbox="155 691 298 719">(if equipped)</p> <div data-bbox="119 727 213 789" style="border: 1px solid black; padding: 5px; text-align: center;">  </div>	<p data-bbox="373 621 657 712">Indicates that the Blind Spot Monitor system is malfunction.</p> <p data-bbox="389 721 642 748">A buzzer also sounds.</p>	<p data-bbox="710 589 976 776">Press the ON-OFF button once to deactivate the system, and then press the button again to reactivate the system.</p>

■ Warning light display in vehicle-to-vehicle distance control mode

In the following cases, the warning light may not be displayed even if vehicle-to-vehicle distance closes.

- When your vehicle and the vehicle ahead are traveling at the same speed or the vehicle ahead is traveling more quickly than your vehicle
- When the vehicle ahead is traveling at a very low speed
- Immediately after cruise control speed is set
- At the instant the accelerator pedal is depressed

5-2. Steps to take in an emergency If you have a flat tire

Your vehicle is equipped with a spare tire. The flat tire can be replaced with the spare tire.

■ Before jacking up the vehicle

- Stop the vehicle on a hard, flat surface.
- Press the height control mode select switch to set the height control system to manual mode (if equipped)
- Set the parking brake.
- Shift the shift lever to P.
- Stop the engine.
- Turn on the emergency flashers.

■ Location of the spare tire

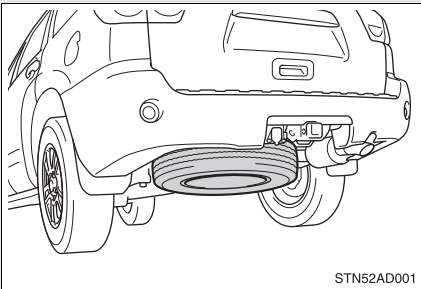

■ Location of the jack and tools

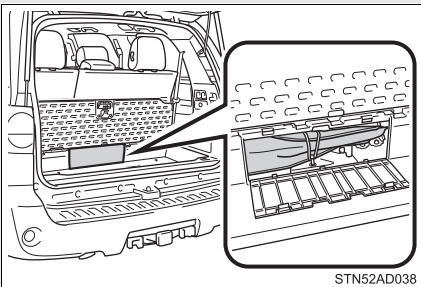

Taking out the jack and tool bag

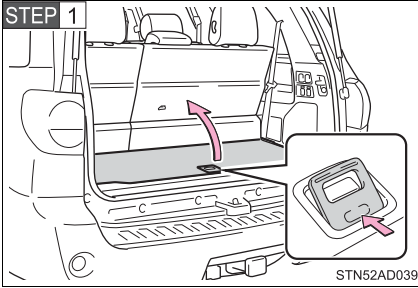

Pull the deck board up.

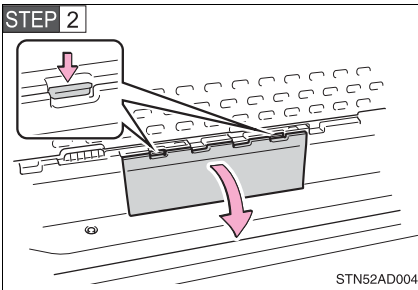

Remove the cover and loosen the strap.

Remove the tools.

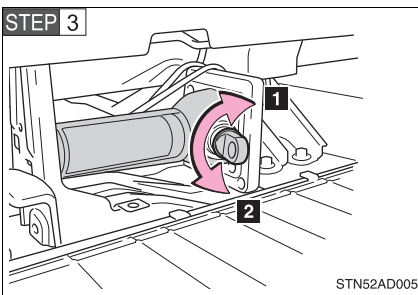

1 Tighten

2 Loosen

Taking out the spare tire

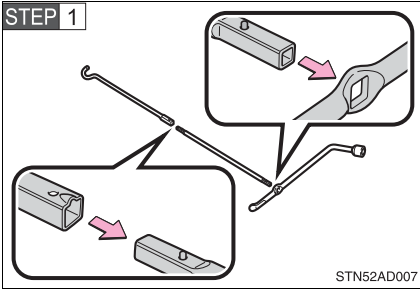

Assemble the jack handle extension as shown.

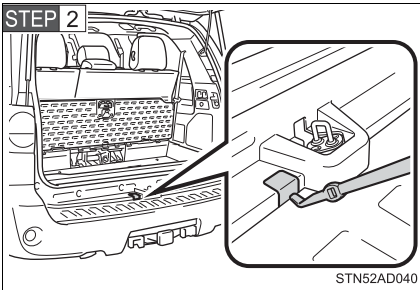

Remove the cover.

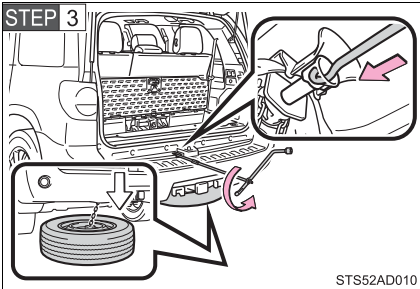

Insert the end of the jack handle extension into the lowering screw and turn it counterclockwise.

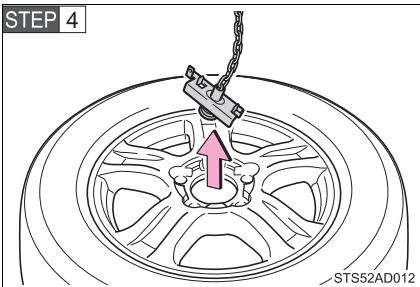

After the tire is lowered completely to the ground, remove the holding bracket.

Replacing a flat tire

STEP 1

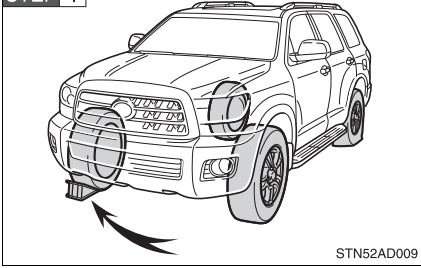

Chock the tires.

Flat tire		Wheel chock positions
Front	Left-hand side	Behind the rear right-hand side tire
	Right-hand side	Behind the rear left-hand side tire
Rear	Left-hand side	In front of the front right-hand side tire
	Right-hand side	In front of the front left-hand side tire

STEP 2

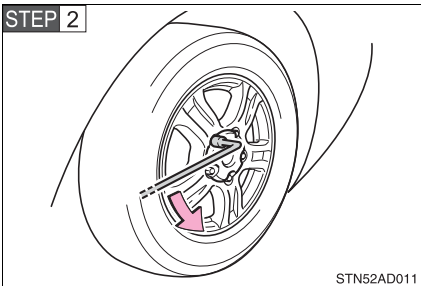

Slightly loosen the wheel nuts (one turn).

5-2. Steps to take in an emergency

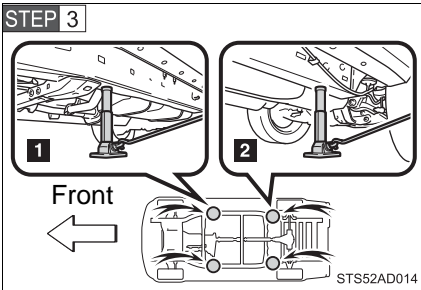

Position the jack at the correct jack point as shown.

- 1 Front
- 2 Rear

Make sure the jack is positioned on a level and solid place.

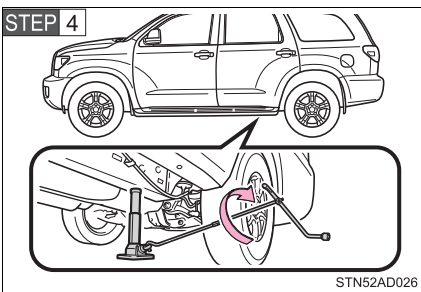

Raise the vehicle until the tire is slightly raised off the ground.

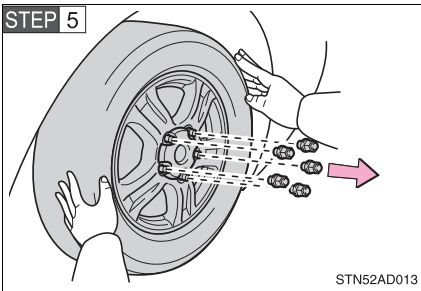

Remove all the wheel nuts and the tire.

When resting the tire on the ground, place the tire so that the wheel design faces up to avoid scratching the wheel surface.

Installing the tire

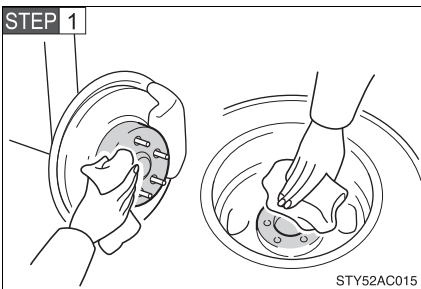

Remove any dirt or foreign matter from the wheel contact surface.

If foreign matter is on the wheel contact surface, the wheel nuts may loosen while the vehicle is in motion, and the tire may come off the vehicle.

STEP 2 Install the tire and loosely tighten each wheel nut by hand by approximately the same amount.

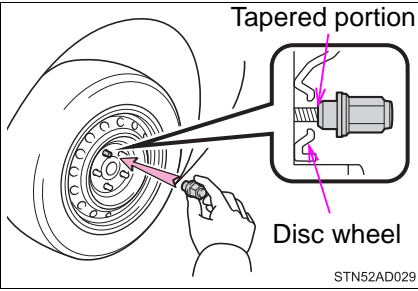

Tighten the nuts until the tapered portion comes into loose contact with the disc wheel.

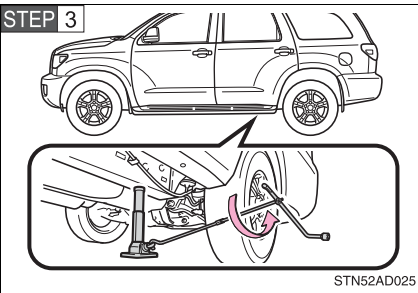

Lower the vehicle.

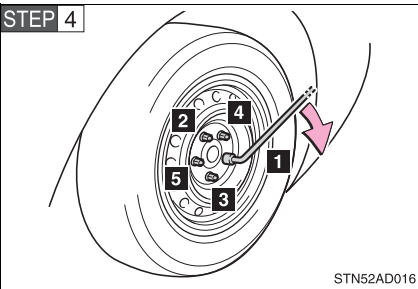

Firmly tighten each nut two or three times in the order shown in the illustration.

Tightening torque:
154 ft·lbf (209 N·m, 21.3 kgf·m)*

*:When used on aluminum wheel, apply 97 ft·lbf (131 N·m, 13.4 kgf·m)

⚠ CAUTION

■ Stowing the flat tire

Failure to follow steps listed under stowing the tire may result in damage to the spare tire carrier and loss of the tire, which could result in serious injury or death.

Stowing the flat tire, jack and all tools

STEP 1 Remove the center wheel ornament by pushing from the reverse side.

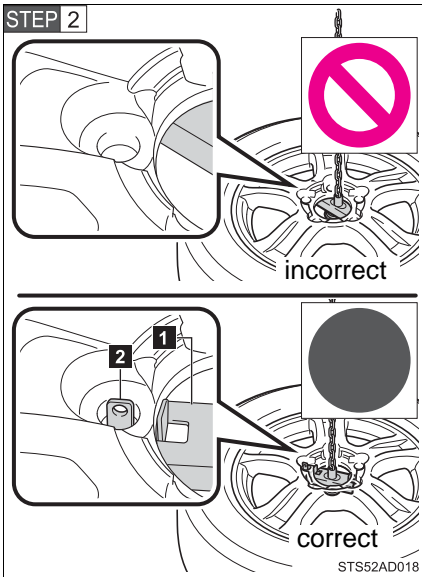

Lay down the tire with the valve stem facing up and install the holding bracket, inserting the claw into the wheel lug nut hole. Turn the jack handle extension clockwise to take up slack in the chain.

Then, check to ensure the claw is in the wheel lug nut hole and the holding bracket is centered in the wheel hub.

1 Holding bracket

2 Claw

While raising, secure the tire, taking care that the tire goes straight up without catching on any surrounding part to prevent it from flying forward during a collision or sudden braking.

Tightening torque:

34.7 ft·lbf (46.6 N·m, 4.8 kgf·m)

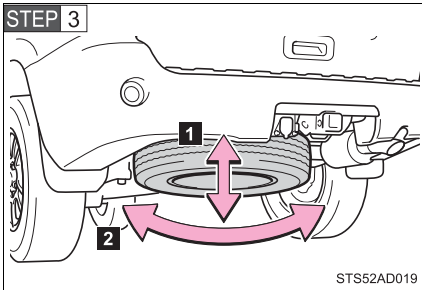

Confirm that the tire is not loose after tightening:

- 1 Push and pull the tire
- 2 Try rotating

Visually check to ensure the tire is not hung on surrounding parts.

If looseness or misassembly exists, repeat step 2 and step 3.

STEP 4 Repeat step 3 any time the tire is lowered or disturbed.

STEP 5 Stow the tools and jack securely.

■ After completing the tire change

The tire pressure warning system must be reset. (→P. 417)

■ When using the temporary spare tire

As the temporary spare tire is not equipped with the tire pressure warning valve and transmitter, low inflation pressure of the temporary spare tire will not be warned. Also, if you replace the temporary spare tire after the tire pressure warning light comes on, the light remains on.

⚠ CAUTION

■ Using the jack

Improper use of the jack may lead to death or serious injuries due to the vehicle suddenly falling off the jack.

- Do not use the jack for any purpose other than replacing tires or installing and removing tire chains.
- Only use the jack that comes with this vehicle for replacing a flat tire. Do not use it on other vehicles, and do not use other jacks for replacing tires on this vehicle.
- Always check that the jack is securely set to the jack point.
- Do not put any part of your body under the vehicle supported by a jack.
- Do not start or run the engine while your vehicle is supported by the jack.
- Do not raise the vehicle while someone is in it.
- When raising the vehicle, do not put an object on or under the jack.
- Do not raise the vehicle to a height greater than that required to replace the tire.
- Use a jack stand if it is necessary to get under the vehicle.

Take particular care when lowering the vehicle to ensure that no one working on or near the vehicle will be injured.

 CAUTION

■ **Using the jack handle**

Insert the square head securely until you hear a click to prevent the extension parts from coming apart unexpectedly.

■ **Replacing a flat tire**

Observe the following precautions to reduce the risk of death or serious injury.

- Retighten the wheel nuts within 100 miles (160 km) of driving. Otherwise, the nuts may loosen and the wheels may fall off, which could cause a serious accident.
- Lower the spare tire completely to the ground before removing it from under the vehicle.
- Do not try to remove the wheel ornament by hand. Take due care in handling the ornament to avoid unexpected personal injury.
- Have the wheel nuts tightened with a torque wrench as soon as possible after changing wheels.

Steel wheel: 154 ft·lbf (209 N·m, 21.3 kgf·m)

Aluminum wheel: 97 ft·lbf (131 N·m, 13.4 kgf·m)

Failure to follow these precautions could cause the nuts to loosen and the wheels may fall off, which could lead to an accident causing death or serious injury.

- Do not attach a heavily damaged wheel ornament, as it may fly off the wheel while the vehicle is moving.
- Be sure to install the wheel nuts with the tapered end facing inward. (→P. 428)

■ **When using the temporary spare tire**

- Remember that your temporary spare tire is specifically designed for use with your vehicle. Do not use your temporary spare tire on another vehicle.
- Do not use two temporary spare tires simultaneously.
- Replace the temporary spare tire with a standard tire as soon as possible.
- Avoid sudden acceleration, deceleration and braking, as well as sharp cornering.

 CAUTION**■ Speed limit when using the temporary spare tire**

Do not drive at speeds in excess of 50 mph (80 km/h) when a temporary spare tire is installed on the vehicle.

The temporary spare tire is not designed for driving at high speeds. Failing to observe this precaution may lead to an accident causing death or serious injury.

■ Driving with tire chains and the temporary spare tire

Do not fit tire chains to the temporary spare tire.

Tire chains may damage the vehicle body and adversely affect driving performance.

■ When the temporary spare tire is attached

The vehicle speed may not be correctly detected, and the following systems may not operate correctly:

- ABS & Brake assist
- VSC
- TRAC
- A-TRAC
- AUTO LSD
- Cruise control
- Navigation system (if equipped)

Also, not only can the following system not be utilized fully, it may actually negatively effect the drive-train components:

- 4WD system

 NOTICE

■ **Do not drive the vehicle with a flat tire.**

Do not continue driving with a flat tire.

Driving even a short distance with a flat tire can damage the tire and the wheel beyond repair.

■ **When replacing the tires**

● When removing or fitting the wheels, tires or the tire pressure warning valve and transmitter, contact your Toyota dealer as the tire pressure warning valve and transmitter may be damaged if not handled correctly.

● Replace the grommets for the tire pressure warning valves and transmitters as well.

■ **To avoid damage to the tire pressure warning valves and transmitters**

When a tire is repaired with liquid sealants, the tire pressure warning valve and transmitter may not operate properly. If a liquid sealant is used, contact your Toyota dealer or other qualified service shop as soon as possible. Make sure to replace the tire pressure warning valve and transmitter when replacing the tire. (→P. 417)

5-2. Steps to take in an emergency If the engine will not start

If the engine still does not start after following the correct starting procedure (→P. 158) or releasing the steering lock (→P. 159), confirm the following points.

■ **The engine will not start even when the starter motor operates normally.**

One of the following may be the cause of the problem.

- There may not be sufficient fuel in the vehicle's tank.
Refuel the vehicle. (→P. 100)

Flex-fuel vehicles: The type of fuel may be different. When refueling, add the same type of fuel, if available.

After adding a different type of fuel, the engine may run roughly and driving performance may be reduced for a while when the engine is first started. In this case, wait until the engine runs normally.

- The engine may be flooded.
Try to restart the engine once more following correct starting procedures.
- There may be a malfunction in the engine immobilizer system.
(→P. 105)

■ **The starter motor turns over slowly, the interior lights and headlights are dim, or the horn does not sound or sounds at a low volume.**

One of the following may be the cause of the problem.

- The battery may be discharged. (→P. 501)
- The battery terminal connections may be loose or corroded.

■ **The starter motor does not turn over, the interior lights and headlights do not turn on, or the horn does not sound.**

One of the following may be the cause of the problem.

- One or both of the battery terminals may be disconnected.
- The battery may be discharged. (→P. 501)

Contact your Toyota dealer if the problem cannot be repaired, or if repair procedures are unknown.

5-2. Steps to take in an emergency

If the shift lever cannot be shifted from P

If the shift lever cannot be shifted with your foot on the brake, there may be a problem with the shift lock system (a system to prevent accidental operation of the shift lever). Have the vehicle inspected by your Toyota dealer immediately.

The following steps may be used as an emergency measure to ensure that the shift lever can be shifted.

STEP 1 Set the parking brake.

STEP 2 Turn the engine switch to the ACC or ON position.

STEP 3 Depress the brake pedal.

STEP 4

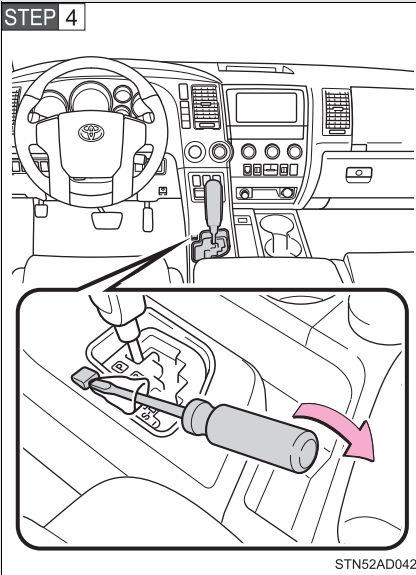

Pry the cover up with a flat-head screwdriver or equivalent.

STEP 5

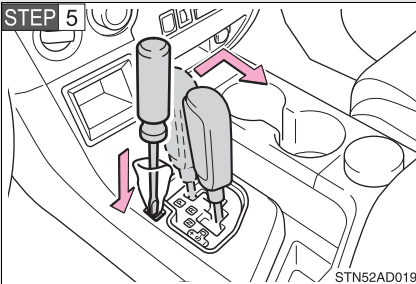

Press the shift lock override button.

The shift lever can be shifted while the button is pressed.

If you lose your keys

New genuine Toyota keys can be made by your Toyota dealer using one of the master keys and the key number stamped on your key number plate. (→P. 30)

■ **If you lose all your master keys.**

You cannot make new keys; the whole engine immobilizer system must be replaced.

5-2. Steps to take in an emergency

If the vehicle battery is discharged

The following procedures may be used to start the engine if the vehicle's battery is discharged.

You can call your Toyota dealer or qualified repair shop.

If you have a set of jumper (or booster) cables and a second vehicle with a 12-volt battery, you can jump start your Toyota following the steps below.

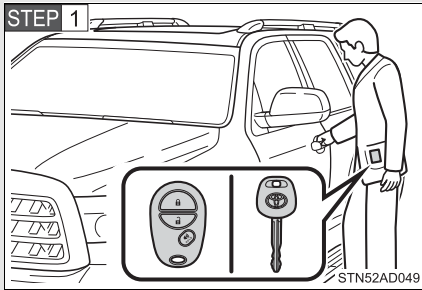

Confirm that the key and wireless remote control are being carried.

When connecting the jumper (or booster) cables, depending on the situation, the alarm may activate and the doors may lock. (→P. 109)

STEP 2 Connect the jumper cables.

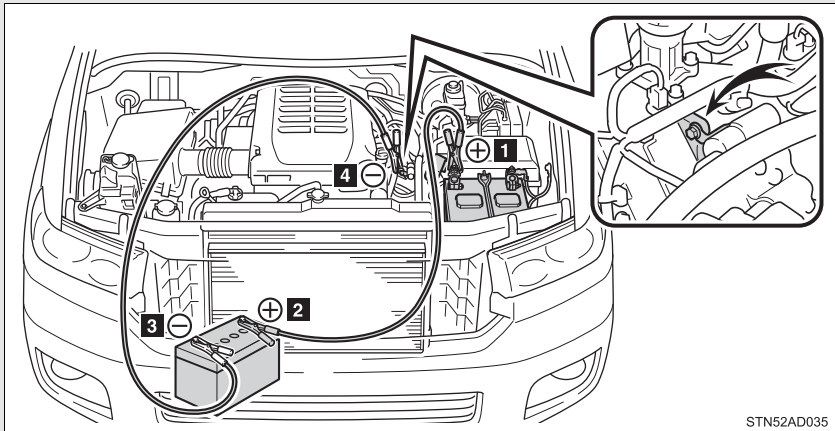

- 1** Positive (+) battery terminal on your vehicle
- 2** Positive (+) battery terminal on the second vehicle
- 3** Negative (-) battery terminal on the second vehicle
- 4** Connect the jumper cable to ground on your vehicle as shown in the illustration.

STEP 3 Start the engine of the second vehicle. Increase the engine speed slightly and maintain at that level for approximately 5 minutes to recharge the battery of your vehicle.

STEP 4 Maintain the engine speed of the second vehicle and start the vehicle's engine.

STEP 5 Once the vehicle's engine has started, remove the jumper cables in the exact reverse order in which they were connected.

Once the engine starts, have the vehicle checked at your Toyota dealer as soon as possible.

■ Starting the engine when the battery is discharged

The engine cannot be started by push-starting.

■ Avoiding a discharged battery

- Turn off the headlights and the audio system while the engine is turned off.
- Turn off any unnecessary electrical components when the vehicle is running at a low speed for an extended period, such as in heavy traffic, etc.

■ When the battery is removed or discharged

Flex-fuel vehicles: The information recorded in the computer will be cleared, which may cause the engine to run roughly and reduce driving performance for a while when the engine is first started. In this case, wait until the engine runs normally.

If the vehicle is running on E85, the engine may stall. In this case, restart the engine, repeatedly if necessary.

■ Charging the battery

The electricity stored in the battery will discharge gradually even when the vehicle is not in use, due to natural discharge and the draining effects of certain electrical appliances. If the vehicle is left for a long time, the battery may discharge, and the engine may be unable to start. (The battery recharges automatically during driving.)

 **CAUTION**
■ Avoiding battery fires or explosions

Observe the following precautions to prevent accidentally igniting the flammable gas that may be emitted from the battery.

- Make sure the jumper cable is connected to the correct terminal and that it is not unintentionally in contact with any part other than the intended terminal.
- Do not allow the jumper cables to come into contact with the “+” and “-” terminals.
- Do not smoke, use matches, cigarette lighters or allow open flame near the battery.

■ Battery precautions

The battery contains poisonous and corrosive acidic electrolyte, while related parts contain lead and lead compounds. Observe the following precautions when handling the battery.

When working with the battery, always wear safety glasses and take care not to allow any battery fluids (acid) to come into contact with skin, clothing or the vehicle body.

- Do not lean over the battery.
- In the event that battery fluid comes into contact with the skin or eyes, immediately wash the affected area with water and seek medical attention. Place a wet sponge or cloth over the affected area until medical attention can be received.
- Always wash your hands after handling the battery support, terminals, and other battery-related parts.
- Do not allow children near the battery.

 **NOTICE**
■ When handling jumper cables

Be careful that the jumper cables do not become tangled in the cooling fan or any of the belts when connecting or disconnecting them.

5-2. Steps to take in an emergency If your vehicle overheats

The following may indicate that your vehicle is overheating.

- The needle of the engine coolant temperature gauge (→P. 168) enters the red zone or a loss of engine power is experienced. (For example, the vehicle speed does not increase.)
- Steam comes out from under the hood.

Correction procedures

STEP 1 Stop the vehicle in a safe place and turn off the air conditioning system, and then stop the engine.

STEP 2 If you see steam:

Carefully lift the hood after the steam subsides.

If you do not see steam:

Carefully lift the hood.

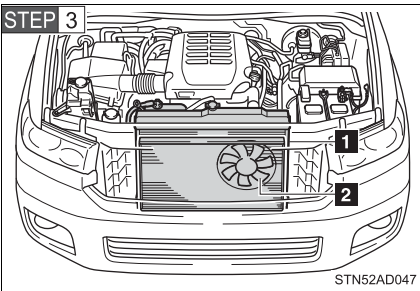

After the engine has cooled down sufficiently, inspect the hoses and radiator core (radiator) for any leaks.

- 1** Radiator
- 2** Cooling fan

If a large amount of coolant leaks, immediately contact your Toyota dealer.

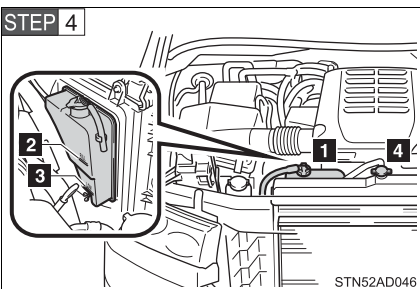

The coolant level is satisfactory if it is between the "FULL" and "LOW" lines on the reservoir.

- 1** Engine coolant reservoir
- 2** "FULL"
- 3** "LOW"
- 4** Radiator cap

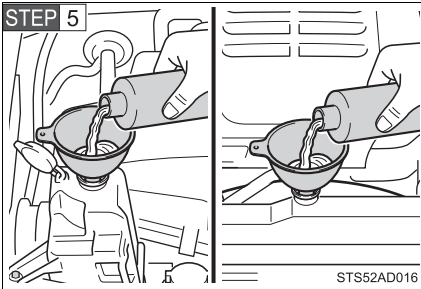

Add coolant if necessary.

Water can be used in an emergency if coolant is unavailable.

STEP 6 Start the engine to check that the radiator cooling fan operates and to check for coolant leaks from the radiator or hoses.

STEP 7 If the fan is not operating:

Stop the engine immediately and contact your Toyota dealer.

If the fan is operating:

Have the vehicle inspected at the nearest Toyota dealer.

CAUTION

■ To prevent an accident or injury when inspecting under the hood of your vehicle

- If steam is seen coming from under the hood, do not open the hood until the steam has subsided. The engine compartment may be very hot, causing serious injuries such as burns.
- Keep hands and clothing (especially a tie, a scarf or a muffler) away from the fan and belts. Failure to do so may cause the hands or clothing to be caught, resulting in serious injury.
- Do not loosen the radiator cap and coolant reservoir while the engine and radiator are hot.
Serious injury, such as burns, may result from hot coolant and steam released under pressure.

 NOTICE

■ **When adding engine coolant**

Wait until the engine has cooled down before adding engine coolant. When adding coolant, do so slowly. Adding cool coolant to a hot engine too quickly can cause damage to the engine.

■ **To prevent damage to the cooling system**

Observe the following precautions:

- Avoid contaminating the coolant with foreign matter (such as sand or dust etc.).
- Do not use any coolant additives.

5-2. Steps to take in an emergency If the vehicle becomes stuck

Carry out the following procedures if the tires spin or the vehicle becomes stuck in mud, dirt, or snow.

- STEP 1** Stop the engine. Set the parking brake and put the shift lever in P.
- STEP 2** Remove the mud, snow, or sand from around the stuck tire.
- STEP 3** Place wood, stones or some other material to help provide traction under the tires.
- STEP 4** Restart the engine.
- STEP 5** Turn off the VSC. (→P. 247, 249)
- STEP 6** Shift the shift lever to D or R and carefully apply the accelerator to free the vehicle.

CAUTION

■ **When attempting to free a stuck vehicle**

If you choose to rock the vehicle back and forth to free it, make sure the surrounding area is clear, to avoid striking other vehicles, objects or persons. The vehicle may also lunge forward or lunge back suddenly as it becomes free. Use extreme caution.

■ **When shifting the shift lever**

Be careful not to shift the shift lever with the accelerator pedal depressed. This may lead to unexpected rapid acceleration of the vehicle that may cause an accident and result in death or serious injury.

 NOTICE

■ **To avoid damaging the transmission and other components**

- Avoid spinning the wheels and do not rev the engine.
- If the vehicle remains stuck after trying these procedures, the vehicle may require towing to be freed.
- When the automatic transmission fluid temperature warning light comes on while attempting to free a stuck vehicle, immediately remove your foot from the accelerator pedal and wait until the warning light turns off. Otherwise, the transmission may become damaged. (vehicles without multi-information display) (→P. 471)
- When a warning message for the automatic transmission fluid temperature is displayed while attempting to free a stuck vehicle, immediately remove your foot from the accelerator pedal and wait until the warning message disappears. Otherwise, the transmission may become damaged. (vehicles with multi-information display) (→P. 481)

5-2. Steps to take in an emergency

If your vehicle has to be stopped in an emergency

Only in an emergency, such as if it becomes impossible to stop the vehicle in the normal way, stop the vehicle using the following procedure:

STEP 1 Steadily step on the brake pedal with both feet and firmly depress it.

Do not pump the brake pedal repeatedly as this will increase the effort required to slow the vehicle.

STEP 2 Shift the shift lever to N.

► If the shift lever is shifted to N

STEP 3 After slowing down, stop the vehicle in a safe place by the road.

STEP 4 Stop the engine.

► If the shift lever cannot be shifted to N

STEP 3 Keep depressing the brake pedal with both feet to reduce vehicle speed as much as possible.

STEP 4

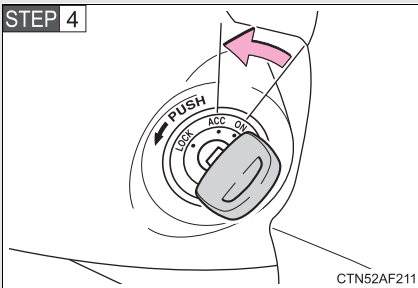

Stop the engine by turning the engine switch to the ACC position.

STEP 5 Stop the vehicle in a safe place by the road.

 CAUTION

■ **If the engine has to be turned off while driving**

- Power assist for the brakes and steering wheel will be lost, making the brake pedal harder to depress and the steering wheel heavier to turn. Decelerate as much as possible before turning off the engine.
- Never attempt to remove the key, as doing so will lock the steering wheel.

6-1. Specifications

Maintenance data
(fuel, oil level, etc.)..... 512
Fuel information 523
Tire information 528

6-2. Customization

Customizable features 539
Items to initialize 543

6-1. Specifications

Maintenance data (fuel, oil level, etc.)

Dimensions

Overall length	205.1 in. (5210 mm)
Overall width	79.9 in. (2030 mm)
Overall height*	77.0 in. (1955 mm)
Wheelbase	122.0 in. (3100 mm)
Front tread	67.9 in. (1725 mm)
Rear tread	69.1 in. (1755 mm)

*: Unladen vehicle

Weight

Model code*1	Engine	Driving system	Vehicle capacity weight (Occupants+luggage)	TWR* (Trailer weight + cargo)	
USK60L-GKTSKA	5.7L V8 (3UR-FE) engine	2WD	1310 lb. (590 kg)	7400 lb. (3357 kg)	
USK60L-GKTLKA			1330 lb. (600 kg)	7300 lb. (3311 kg)	
USK60L-GKTZKA			1315 lb. (595 kg)	7200 lb. (3266 kg)	
USK65L-GKTSKA		5.7L V8 (3UR-FBE) engine	4WD	1255 lb. (565 kg)	7100 lb. (3245 kg)
USK65L-GKTLKA				1275 lb. (575 kg)	7100 lb. (3230 kg)
USK65L-GKTZKA				1265 lb. (570 kg)	7000 lb. (3200 kg)
USK65L-GKTSGA	1255 lb. (565 kg)			7100 lb. (3221 kg)	
USK65L-GKTLGA	1275 lb. (575 kg)				
USK65L-GKTZGA	1265 lb. (570 kg)			7000 lb. (3175 kg)	

*1: The model code is indicated on the Certification Label. (→P. 514)

*: This model meets the tow-vehicle trailering requirement of SAE International per SAE J2807.

Vehicle identification

■ Vehicle identification number

The vehicle identification number (VIN) is the legal identifier for your vehicle. This is the primary identification number for your Toyota. It is used in registering the ownership of your vehicle.

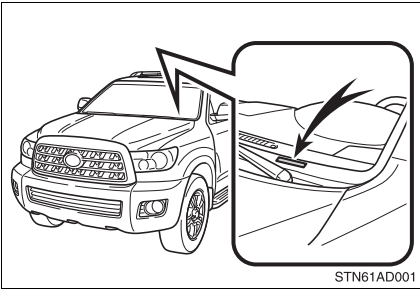

This number is stamped on the top left of the instrument panel.

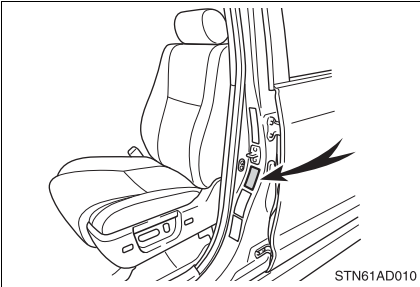

This number is also on the Certification Label.

■ Engine number

The engine number is stamped on the engine block as shown.

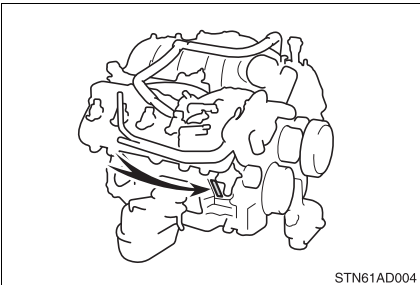

Engine

Model	3UR-FE and 3UR-FBE
Type	8-cylinder V-type, 4-cycle, gasoline
Bore and stroke	3.70 × 4.02 in. (94.0 × 102.0 mm)
Displacement	345.6 cu.in. (5663 cm ³)
Valve clearance (engine cold)	Automatic adjustment
Drive belt tension	Automatic adjustment

Fuel

Engine	Model	3UR-FE engine	3UR-FBE engine
	Type	Gasoline engine	Flex-fuel engine
Fuel type		Unleaded gasoline only	Unleaded gasoline, E85, or a blend of the two fuels
Octane rating (Unleaded gasoline)		87 (Research Octane Number91) or higher	
Ethanol percentage (E85)		—	85% or less
Fuel tank capacity (Reference)		26.4 gal. (100.0 L, 22.0 Imp.gal.)	

Lubrication system

Oil capacity (Drain and refill-reference*)	
▶ With filter	7.9 qt. (7.5 L, 6.6 Imp.qt.)
▶ Without filter	7.5 qt. (7.1 L, 6.2 Imp.qt.)

*: The engine oil capacity is a reference quantity to be used when changing the engine oil. Warm up and turn off the engine, wait more than 5 minutes, and check the oil level on the dipstick.

■ Engine oil selection

“Toyota Genuine Motor Oil” is used in your Toyota vehicle. Use Toyota approved “Toyota Genuine Motor Oil” or equivalent to satisfy the following grade and viscosity.

Oil grade: ILSAC GF-5 multigrade engine oil

Recommended viscosity: SAE 0W-20

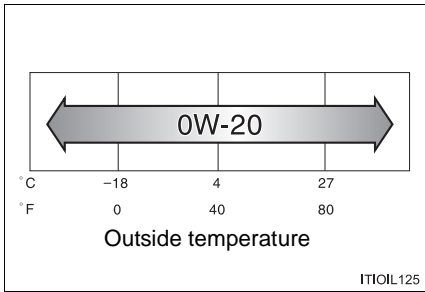

SAE 0W-20 is the best choice for good fuel economy and good starting in cold weather.

If SAE 0W-20 is not available, SAE 5W-20 oil may be used. However, it must be replaced with SAE 0W-20 at the next oil change.

Oil viscosity (0W-20 is explained here as an example):

- The 0W in 0W-20 indicates the characteristic of the oil which allows cold startability. Oils with a lower value before the W allow for easier starting of the engine in cold weather.
- The 20 in 0W-20 indicates the viscosity characteristic of the oil when the oil is at high temperature. An oil with a higher viscosity (one with a higher value) may be better suited if the vehicle is operated at high speeds, or under extreme load conditions.

How to read oil container label:

The International Lubricant Specification Advisory Committee (ILSAC) Certification Mark is added to some oil containers to help you select the oil you should use.



Cooling system

Capacity	<ul style="list-style-type: none"> ▶ Vehicles without towing package 13.1 qt. (12.4 L, 10.9 Imp.qt.) ▶ Vehicles with towing package 14.1 qt. (13.3 L, 11.7 Imp.qt.)
Coolant type	<p>Use either of the following.</p> <ul style="list-style-type: none"> • “Toyota Super Long Life Coolant” • Similar high-quality ethylene glycol-based non-silicate, non-amine, non-nitrite, and non-borate coolant with long-life hybrid organic acid technology <p>Do not use plain water alone.</p>

Ignition system

Spark plug		
Make	DENSO	SK20HR11
Gap		0.043 in. (1.1 mm)

NOTICE

Iridium-tipped spark plugs

Use only iridium-tipped spark plugs. Do not adjust gap when tuning engine.

Electrical system

Battery	
Open voltage at 68°F (20°C):	12.6 — 12.8 V Fully charged 12.2 — 12.4 V Half charged 11.8 — 12.0 V Discharged (Voltage checked 20 minutes after the key is removed with all the lights turned off)
Charging rates	5 A max.

Differential

Oil capacity	Front (4WD models)	2.17 qt. (2.05 L, 1.80 Imp.qt.)
	Rear	1.64 qt. (1.55 L, 1.36 Imp.qt.)
Oil type and viscosity*		Toyota Genuine Differential Gear Oil LT 75W-85 GL-5 or equivalent

*: Your Toyota vehicle is filled with “Toyota Genuine Differential Gear Oil” at the factory. Use Toyota approved “Toyota Genuine Differential Gear Oil” or an equivalent of matching quality to satisfy the above specification. Please contact your Toyota dealer for further details.

Automatic transmission

Fluid capacity*	11.7 qt. (11.1 L, 9.8 Imp.qt.)
Fluid type	Toyota Genuine ATF WS

*: The fluid capacity is the quantity of reference. If replacement is necessary, contact your Toyota dealer.

NOTICE

■ Automatic transmission fluid type

Using automatic transmission fluid other than “Toyota Genuine ATF WS” may cause deterioration in shift quality, locking up of your transmission accompanied by vibration, and ultimately damage the automatic transmission of your vehicle.

Transfer (4WD models)

Oil capacity	1.43 qt. (1.35 L, 1.19 Imp.qt.)
Oil type	Gear oil API GL-5
Recommended oil viscosity	SAE 75W-90

Brakes

Pedal clearance ^{*1}	4.1 in. (104 mm) Min.
Pedal free play	0.04 — 0.24 in. (1 — 6 mm)
Brake pad wear limit	0.04 in. (1.0 mm)
Parking brake lining wear limit	0.04 in. (1.0 mm)
Parking brake pedal travel ^{*2}	6 — 9 clicks
Fluid type	FMVSS No. 116 DOT 3 or SAE J1703

*1: Minimum pedal clearance when depressed with a force of 110 lbf (490 N, 50 kgf) with the engine running.

*2: Parking brake pedal travel when depressed with a force of 67.1 lbf (300 N, 30.6 kgf).

Chassis lubrication (4WD models)

Propeller shafts	Spider	Lithium base chassis grease, NLGI No.2
------------------	--------	--

Steering

Free play	Less than 1.2 in. (30 mm)
Power steering fluid type	Automatic transmission fluid DEXRON [®] II or III

Tires and wheels

► Type A

Tire size	P275/65R18 114T, P255/70R18 112T (spare tire)
Tire inflation pressure (Recommended cold tire inflation pressure)	Front tires: 33 psi (230 kPa, 2.3 kgf/cm ² or bar) Rear tires: 33 psi (230 kPa, 2.3 kgf/cm ² or bar) Spare tire: 33 psi (230 kPa, 2.3 kgf/cm ² or bar)
Wheel size	18 × 8J
Wheel nut torque	Steel wheels: 154 ft·lbf (209 N·m, 21.3 kgf·m) Aluminum wheels: 97 ft·lbf (131 N·m, 13.4 kgf·m)

► Type B

Tire size	P275/55R20 111H, P255/70R18 112T (spare tire)
Tire inflation pressure (Recommended cold tire inflation pressure)	Front tires: 30 psi (210 kPa, 2.1 kgf/cm ² or bar) Rear tires: 33 psi (230 kPa, 2.3 kgf/cm ² or bar) Spare tire: 33 psi (230 kPa, 2.3 kgf/cm ² or bar)
Wheel size	20 × 8J, 18 × 8J (spare wheel)
Wheel nut torque	Steel wheels: 154 ft·lbf (209 N·m, 21.3 kgf·m) Aluminum wheels: 97 ft·lbf (131 N·m, 13.4 kgf·m)

Light bulbs

	Light Bulbs	Bulb No.	W	Type
Exterior	Headlights (high beam)	9005	60	A
	Headlights (low beam)	—	55	B
	Front fog lights	9145	45	C
	Front side marker lights	168	5	D
	Front turn signal/parking lights	4157NAK	27/8	E
	Rear turn signal lights	—	21	E
	Stop/tail and rear side marker lights	7443	21/5	D
	Tail lights	194	3.8	D
	Back-up lights	921	16	D
	License plate lights	168	5	D
	Outer foot light	—	5	D
Interior	Vanity lights	7065	1.4	F
	Personal/interior lights			
	Front	—	5	D
	Center	—	5	D
	Rear	—	5	D
	Interior light	7506	5	F
	Foot well lighting	—	1.4	D
Door courtesy lights	168	5	D	

A: HB3 halogen bulbs

B: H11 halogen bulbs

C: H10 halogen bulbs

D: Wedge base bulbs (clear)

E: Wedge base bulbs (amber)

F: Double end bulbs

Fuel information

▶ Gasoline engine (→P. 515)

You must only use unleaded gasoline.

Select octane rating 87 (Research Octane Number 91) or higher. Use of unleaded gasoline with an octane rating lower than 87 may result in engine knocking. Persistent knocking can lead to engine damage.

At minimum, the gasoline you use should meet the specifications of ASTM D4814 in the U.S.A.

▶ Flex-fuel engine (→P. 515)

You must only use unleaded gasoline, E85, or a blend of the two fuels.

Unleaded gasoline (Octane rating 87 [Research Octane Number 91] or higher), E85, or a blend of two fuels is required for optimum engine performance.

The use of unleaded gasoline with an octane rating lower than 87 may result in engine knocking. Persistent knocking can lead to engine damage.

The use of fuel with an ethanol concentration in excess of 85% will have a negative impact on driving performance and can cause damage to the fuel system components.

At minimum, the gasoline you use should meet the specifications of ASTM D4814 in the U.S.A.

At minimum, the E85 you use should meet the specifications of ASTM D5798 in the U.S.A.

■ Identifying flex-fuel vehicles

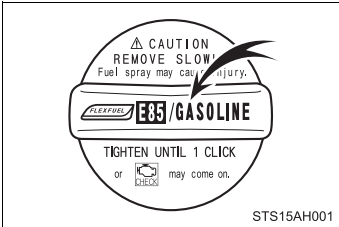

Flex-fuel vehicles can be identified by the fuel tank cap, which is marked “FLEX-FUEL E85/GASOLINE”.

■ Gasoline quality

In very few cases, driveability problems may be caused by the brand of gasoline you are using. If driveability problems persist, try changing the brand of gasoline. If this does not correct the problem, consult your Toyota dealer.

■ Gasoline quality standards

- Automotive manufacturers in the U.S.A., Europe and Japan have developed a specification for fuel quality called the World-Wide Fuel Charter (WWFC), which is expected to be applied worldwide.
- The WWFC consists of four categories that are based on required emission levels. In the U.S., category 4 has been adopted.
- The WWFC improves air quality by lowering emissions in vehicle fleets, and improves customer satisfaction through better performance.

■ E85 fuel (Flex-fuel engine)

- E85 fuel is a blend of 85% ethanol and 15% gasoline. However, E85 does not necessarily contain 85% ethanol. For example, in cold climates the ethanol content of E85 may be reduced during the winter months to maintain cold weather starting performance.
- E85 has less energy per gallon than gasoline, so you will need to fill your fuel tank more frequently when using E85.
- The number of fuel stations that sell E85 fuel is limited. For more information about fueling stations, please refer to the U.S. Department of Energy Web site.

<http://www.afdc.energy.gov/afdc/locator/stations/>

■ Recommendation of the use of gasoline containing detergent additives

- Toyota recommends the use of gasoline that contains detergent additives to avoid the build-up of engine deposits.
- All gasoline sold in the U.S.A. contains minimum detergent additives to clean and/or keep clean intake systems, per EPA's lowest additives concentration program.
- Toyota strongly recommends the use of Top Tier Detergent Gasoline. For more information on Top Tier Detergent Gasoline and a list of marketers, please go to the official website www.toptiergas.com.

■ Recommendation of the use of low emissions gasoline

Gasolines containing oxygenates such as ethers and ethanol, as well as reformulated gasolines, are available in some cities. These fuels are typically acceptable for use, providing they meet other fuel requirements.

Toyota recommends these fuels, since the formulations allow for reduced vehicle emissions.

■ Non-recommendation of the use of blended gasoline (Gasoline engine)

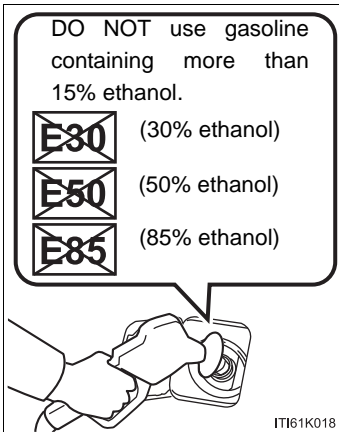

- Use only gasoline containing up to 15% ethanol.

DO NOT use any flex-fuel or gasoline that could contain more than 15% ethanol, including from any pump labeled E30, E50, E85 (which are only some examples of fuel containing more than 15% ethanol).

- If you use gasohol in your vehicle, be sure that it has an octane rating no lower than 87.
- Toyota does not recommend the use of gasoline containing methanol.

■ **Non-recommendation of the use of gasoline containing MMT**

Some gasoline contains an octane enhancing additive called MMT (Methylcyclopentadienyl Manganese Tricarbonyl).

Toyota does not recommend the use of gasoline that contains MMT. If fuel containing MMT is used, your emission control system may be adversely affected.

The malfunction indicator lamp on the instrument cluster may come on. If this happens, contact your Toyota dealer for service.

■ **Non-recommendation of the use of after-market fuel additives (Flex-fuel engine)**

Do not use any after-market fuel additives when repeatedly refueling with E85, as some after-market fuel additives are not compatible with E85.

■ **If your engine knocks**

- Consult your Toyota dealer.
- You may occasionally notice light knocking for a short time while accelerating or driving uphill. This is normal and there is no need for concern.

 **NOTICE**

■ **Notice on fuel quality**

- Do not use improper fuels.
If improper fuels are used, the engine will be damaged.
- Do not use leaded gasoline.
Leaded gasoline can cause damage to your vehicle's three-way catalytic converters causing the emission control system to malfunction.
- Gasoline engine: Do not use gasohol other than the type previously stated.
Other gasohol may cause fuel system damage or vehicle performance problems.
- Using unleaded gasoline with an octane number or rating lower than the level previously stated will cause persistent heavy knocking.
At worst, this will lead to engine damage.

**NOTICE****■ When use of non-specified fuels (Flex-fuel engine)**

The use of non-specified fuels will have a negative impact on starting and driving performance, and will cause damage to the fuel system components. Therefore, do not add fuels such as the following.

- Fuels containing methanol
- Fuels with more than 85% ethanol

■ Fuel-related poor driveability

If poor driveability (poor hot starting, vaporization, engine knocking, etc.) is encountered after using a different type of fuel, discontinue the use of that type of fuel.

■ When refueling with gasohol

Take care not to spill gasohol. It can damage your vehicle's paint.

6-1. Specifications

Tire information

Typical tire symbols

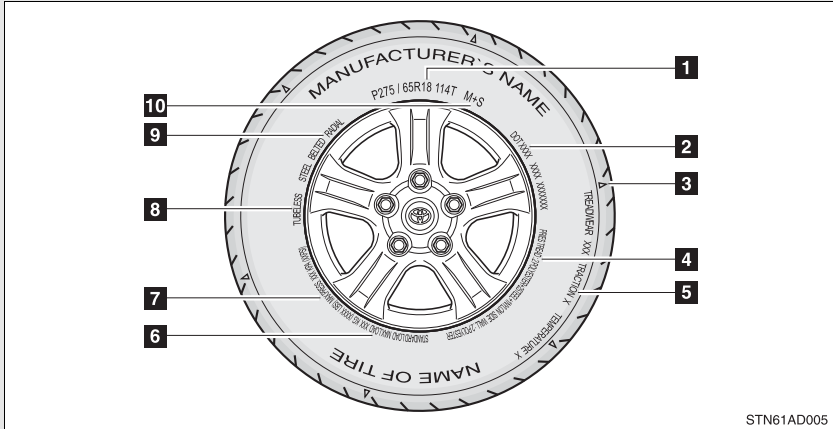

STN61AD005

1 Tire size (→P. 530)

2 DOT and Tire Identification Number (TIN) (→P. 529)

3 Location of treadwear indicators (→P. 415)

4 Tire ply composition and materials

Ply is a layer of rubber-coated parallel cords. Cords are the strands which form the plies in a tire.

5 Uniform tire quality grading

For details, see “Uniform Tire Quality Grading” that follows.

6 Load limit at maximum cold tire inflation pressure (→P. 533)

7 Maximum cold tire inflation pressure (→P. 533)

This means the pressure to which a tire may be inflated.

8 TUBELESS or TUBE TYPE

A tubeless tire does not have a tube and air is directly filled in the tire. A tube type tire has a tube inside the tire and the tube maintains the air pressure.

9 Radial tires or bias-ply tires

A radial tire has RADIAL on the sidewall. A tire not marked RADIAL is a bias-ply tire.

10 Summer tire or all season tire (→P. 419)

An all season tire has M+S on the sidewall. A tire not marked M+S is a summer tire.

Typical DOT and tire identification number (TIN)

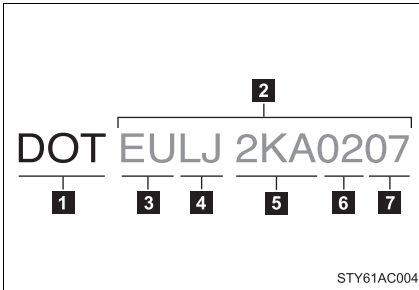
**1** DOT symbol***2** Tire Identification Number (TIN)**3** Tire manufacturer's identification mark**4** Tire size code**5** Manufacturer's optional tire type code (3 or 4 letters)**6** Manufacturing week**7** Manufacturing year

*: The DOT symbol certifies that the tire conforms to applicable Federal Motor Vehicle Safety Standards.

Tire size

■ Typical tire size information

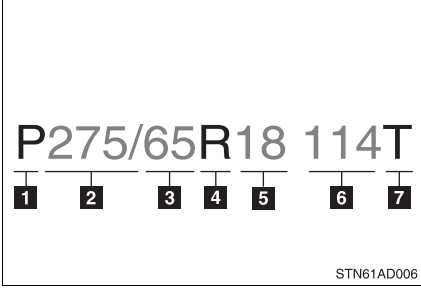

The illustration indicates typical tire size.

- 1** Tire use
(P = Passenger car,
T = Temporary use)
- 2** Section width (millimeters)
- 3** Aspect ratio
(tire height to section width)
- 4** Tire construction code
(R = Radial, D = Diagonal)
- 5** Wheel diameter (inches)
- 6** Load index (2 digits or 3 digits)
- 7** Speed symbol
(alphabet with one letter)

■ Tire dimensions

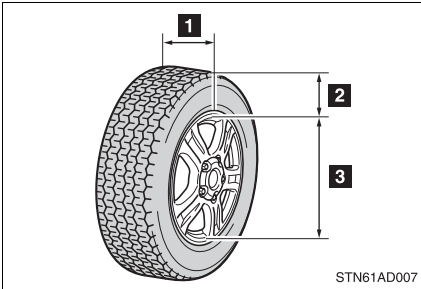

- 1** Section width
- 2** Tire height
- 3** Wheel diameter

Tire section names

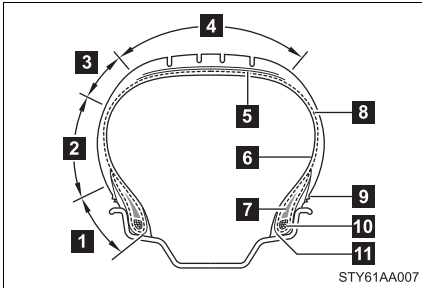

- 1** Bead
- 2** Sidewall
- 3** Shoulder
- 4** Tread
- 5** Belt
- 6** Inner liner
- 7** Reinforcing rubber
- 8** Carcass
- 9** Rim lines
- 10** Bead wires
- 11** Chafer

Uniform Tire Quality Grading

This information has been prepared in accordance with regulations issued by the National Highway Traffic Safety Administration of the U.S.A. Department of Transportation.

It provides the purchasers and/or prospective purchasers of Toyota vehicles with information on uniform tire quality grading.

Your Toyota dealer will help answer any questions you may have as you read this information.

■ DOT quality grades

All passenger vehicle tires must conform to Federal Safety Requirements in addition to these grades. Quality grades can be found where applicable on the tire sidewall between tread shoulder and maximum section width.

For example: Treadwear 200 Traction AA Temperature A

■ Treadwear

The treadwear grade is a comparative rating based on the wear rate of the tire when tested under controlled conditions on a specified government test course.

For example, a tire graded 150 would wear one and a half (1 - 1/2) times as well on the government course as a tire graded 100.

The relative performance of tires depends upon the actual conditions of their use, however, and may depart significantly from the norm due to variations in driving habits, service practices and differences in road characteristics and climate.

■ Traction AA, A, B, C

The traction grades, from highest to lowest, are AA, A, B and C, and they represent the tire's ability to stop on wet pavement as measured under controlled conditions on specified government test surfaces of asphalt and concrete.

A tire marked C may have poor traction performance.

Warning: The traction grade assigned to this tire is based on braking (straight ahead) traction tests and does not include cornering (turning) traction.

■ Temperature A, B, C

The temperature grades are A (the highest), B, and C, representing the tire's resistance to the generation of heat and its ability to dissipate heat when tested under controlled conditions on a specified indoor laboratory test wheel.

Sustained high temperature can cause the material of the tire to degenerate and reduce tire life, and excessive temperature can lead to sudden tire failure.

The grade C corresponds to a level of performance which all passenger car tires must meet under the Federal Motor Vehicle Safety Standard No. 109.

Grades B and A represent higher levels of performance on the laboratory test wheel than the minimum required by law.

Warning: The temperature grades for this tire are established for a tire that is properly inflated and not overloaded.

Excessive speed, underinflation, or excessive loading, either separately or in combination, can cause heat buildup and possible tire failure.

Glossary of tire terminology

Tire related term	Meaning
Cold tire inflation pressure	Tire pressure when the vehicle has been parked for three hours or more, or has not been driven more than 1 mile or 1.5 km under that condition
Maximum inflation pressure	The maximum cold inflated pressure to which a tire may be inflated, shown on the sidewall of the tire
Recommended inflation pressure	Cold tire inflation pressure recommended by a manufacturer
Accessory weight	The combined weight (in excess of those standard items which may be replaced) of transmission, power steering, power brakes, power windows, power seats, radio and heater, to the extent that these items are available as factory-installed equipment (whether installed or not)
Curb weight	The weight of a motor vehicle with standard equipment, including the maximum capacity of fuel, oil and coolant, and if so equipped, air conditioning and additional weight optional engine
Maximum loaded vehicle weight	The sum of: (a) Curb weight (b) Accessory weight (c) Vehicle capacity weight (d) Production options weight

Tire related term	Meaning
Normal occupant weight	150 lb. (68 kg) times the number of occupants specified in the second column of Table 1* that follows
Occupant distribution	Distribution of occupants in a vehicle as specified in the third column of Table 1* below
Production options weight	The combined weight of installed regular production options weighing over 5 lb. (2.3 kg) in excess of the standard items which they replace, not previously considered in curb weight or accessory weight, including heavy duty brakes, ride levelers, roof rack, heavy duty battery, and special trim
Rim	A metal support for a tire or a tire and tube assembly upon which the tire beads are seated
Rim diameter (Wheel diameter)	Nominal diameter of the bead seat
Rim size designation	Rim diameter and width
Rim type designation	The industry manufacturer's designation for a rim by style or code
Rim width	Nominal distance between rim flanges
Vehicle capacity weight (Total load capacity)	The rated cargo and luggage load plus 150 lb. (68 kg) times the vehicle's designated seating capacity
Vehicle maximum load on the tire	The load on an individual tire that is determined by distributing to each axle its share of the maximum loaded vehicle weight, and dividing by two
Vehicle normal load on the tire	The load on an individual tire that is determined by distributing to each axle its share of curb weight, accessory weight, and normal occupant weight (distributed in accordance with Table 1* below), and dividing by two

Tire related term	Meaning
Weather side	The surface area of the rim not covered by the inflated tire
Bead	The part of the tire that is made of steel wires, wrapped or reinforced by ply cords and that is shaped to fit the rim
Bead separation	A breakdown of the bond between components in the bead
Bias ply tire	A pneumatic tire in which the ply cords that extend to the beads are laid at alternate angles substantially less than 90 degrees to the centerline of the tread
Carcass	The tire structure, except tread and sidewall rubber which, when inflated, bears the load
Chunking	The breaking away of pieces of the tread or sidewall
Cord	The strands forming the plies in the tire
Cord separation	The parting of cords from adjacent rubber compounds
Cracking	Any parting within the tread, sidewall, or innerliner of the tire extending to cord material
CT	A pneumatic tire with an inverted flange tire and rim system in which the rim is designed with rim flanges pointed radially inward and the tire is designed to fit on the underside of the rim in a manner that encloses the rim flanges inside the air cavity of the tire
Extra load tire	A tire designed to operate at higher loads and at higher inflation pressures than the corresponding standard tire
Groove	The space between two adjacent tread ribs
Innerliner	The layer(s) forming the inside surface of a tubeless tire that contains the inflating medium within the tire

Tire related term	Meaning
Innerliner separation	The parting of the innerliner from cord material in the carcass
Intended outboard sidewall	(a)The sidewall that contains a whitewall, bears white lettering, or bears manufacturer, brand, and/or model name molding that is higher or deeper than the same molding on the other sidewall of the tire, or (b)The outward facing sidewall of asymmetrical tire that has a particular side that must always face outward when mounted on a vehicle
Light truck (LT) tire	A tire designated by its manufacturer as primarily intended for use on lightweight trucks or multipurpose passenger vehicles
Load rating	The maximum load that a tire is rated to carry for a given inflation pressure
Maximum load rating	The load rating for a tire at the maximum permissible inflation pressure for that tire
Maximum permissible inflation pressure	The maximum cold inflation pressure to which a tire may be inflated
Measuring rim	The rim on which a tire is fitted for physical dimension requirements
Open splice	Any parting at any junction of tread, sidewall, or innerliner that extends to cord material
Outer diameter	The overall diameter of an inflated new tire
Overall width	The linear distance between the exteriors of the sidewalls of an inflated tire, including elevations due to labeling, decorations, or protective bands or ribs
Passenger car tire	A tire intended for use on passenger cars, multipurpose passenger vehicles, and trucks, that have a gross vehicle weight rating (GVWR) of 10,000 lb. or less

Tire related term	Meaning
Ply	A layer of rubber-coated parallel cords
Ply separation	A parting of rubber compound between adjacent plies
Pneumatic tire	A mechanical device made of rubber, chemicals, fabric and steel or other materials, that, when mounted on an automotive wheel, provides the traction and contains the gas or fluid that sustains the load
Radial ply tire	A pneumatic tire in which the ply cords that extend to the beads are laid at substantially 90 degrees to the centerline of the tread
Reinforced tire	A tire designed to operate at higher loads and at higher inflation pressures than the corresponding standard tire
Section width	The linear distance between the exteriors of the sidewalls of an inflated tire, excluding elevations due to labeling, decoration, or protective bands
Sidewall	That portion of a tire between the tread and bead
Sidewall separation	The parting of the rubber compound from the cord material in the sidewall
Snow tire	A tire that attains a traction index equal to or greater than 110, compared to the ASTM E-1136 Standard Reference Test Tire, when using the snow traction test as described in ASTM F-1805-00, Standard Test Method for Single Wheel Driving Traction in a Straight Line on Snow-and Ice-Covered Surfaces, and which is marked with an Alpine Symbol () on at least one sidewall
Test rim	The rim on which a tire is fitted for testing, and may be any rim listed as appropriate for use with that tire

Tire related term	Meaning
Tread	That portion of a tire that comes into contact with the road
Tread rib	A tread section running circumferentially around a tire
Tread separation	Pulling away of the tread from the tire carcass
Treadwear indicators(TWI)	The projections within the principal grooves designed to give a visual indication of the degrees of wear of the tread
Wheel-holding fixture	The fixture used to hold the wheel and tire assembly securely during testing

*:Table 1 — Occupant loading and distribution for vehicle normal load for various designated seating capacities

Designated seating capacity, Number of occupants	Vehicle normal load, Number of occupants	Occupant distribution in a normally loaded vehicle
2 through 4	2	2 in front
5 through 10	3	2 in front, 1 in second seat
11 through 15	5	2 in front, 1 in second seat, 1 in third seat, 1 in fourth seat
16 through 20	7	2 in front, 2 in second seat, 2 in third seat, 1 in fourth seat

Customizable features

Your vehicle includes a variety of electronic features that can be personalized to your preferences. Programming these preferences requires specialized equipment and may be performed by an authorized Toyota dealership.

Some function settings are changed simultaneously with other functions being customized. Contact your Toyota dealer for further details.

Item	Function	Default setting	Customized setting
Wireless remote control (→P. 31)	Wireless remote control	ON	OFF
	Unlocking operation	Driver's door unlocked in one step, all doors unlocked in two steps	All doors unlocked in one step
	Automatic door lock function to be activated if door is not opened after being unlocked	ON	OFF
	Time elapsed before automatic door lock function is activated if door is not opened after being unlocked	60 seconds	30 seconds
			120 seconds
	Operation signal (Emergency flashers)	ON	OFF
	Operation signal (Buzzer)	ON	OFF
	Panic function	ON	OFF
Buzzer sounds when pushing LOCK with any door not closed	ON	OFF	

Item	Function	Default setting	Customized setting
Wireless remote control (→P. 31)	Power back door operation	Push and hold	Push twice*
			One short push*
Power back door (→P. 40)	Switch operation	Push and hold	One short push
	Wireless remote control linked operation	ON	OFF
	Operation signal volume	OFF	ON
	Operation when door locks	Possible	Impossible
	Time elapsed before back door closing function is activated when pushing switch in the luggage compartment	1.5 seconds	0 seconds
			1 seconds
			2 seconds
Door lock (→P. 35)	Speed-detecting automatic door lock function	ON	OFF
	Opening driver's door unlocks all doors.	OFF	ON
	Shifting gears to "P" unlocks all doors.	ON	OFF
	Shifting gears to position other than "P" locks all doors.	OFF	ON

*: It is possible to select them only when the power back door operation with the open/close switch is made impossible when the door is locked.

Item	Function	Default setting	Customized setting
Door lock (→P. 35)	Unlocking using a key	Driver's door unlocked in one step, all doors unlocked in two steps	All doors unlocked in one step
Power windows (→P. 90)	Door key linked operation	Open and close	Open only
			Close only
			OFF
Moon roof (→P. 96)	Door key linked operation	Open and close	Open only
			Close only
	Linked operation of components when door key is used	Slide only	Tilt only
Automatic light off system (→P. 187)	Light sensor sensitivity	Level 3	Level 1 to 5
	Time elapsed before headlights automatically turn off after doors are closed	30 seconds	0 seconds
			60 seconds
90 seconds			
Back window (→P. 93)	Linked back door key operation	Open and close	Open only
	Sensitivity of jam protection function	Level 1	Level 2 to 4
Rear window wiper and washer (→P. 199)	Washer linkage wiper control	ON	OFF
	Drip prevention function	ON	OFF

Item	Function	Default setting	Customized setting
Illumination (→P. 313)	Time elapsed before lights turn off	15 seconds	7.5 seconds
			30 seconds
	Operation after the engine is off	ON	OFF
	Operation when the doors are unlocked	ON	OFF
Seat Belt Reminder Buzzer (→P. 471)	Vehicle speed linked seat belt reminder buzzer	ON	OFF

6-2. Customization

Items to initialize

The following items must be initialized for normal system operation in cases such as after the battery is reconnected, or maintenance is performed on the vehicle.

Item	When to initialize	Reference
Power back door	<ul style="list-style-type: none"> • After reconnecting or changing the battery. • After changing a fuse. 	P. 40
<p>▶ Vehicles without multi-information display</p> <p>Maintenance required reminder light</p> <p>▶ Vehicles with multi-information display</p> <p>Message indicating maintenance is required</p>	After the maintenance is performed	P. 389
Tire pressure warning system	<ul style="list-style-type: none"> • When rotating the tires on vehicles differing with front and rear tire inflation pressures. • When changing the tire inflation pressure by changing traveling speed or load weight, etc. • When changing the tire size. 	P. 417

For owners

7

Reporting safety defects
for U.S. owners 546

Seat belt instructions
for Canadian owners
(in French) 547

SRS airbag instructions
for Canadian owners
(in French) 550

Reporting safety defects for U.S. owners

If you believe that your vehicle has a defect which could cause a crash or could cause injury or death, you should immediately inform the National Highway Traffic Safety Administration (NHTSA) in addition to notifying Toyota Motor Sales, U.S.A., Inc. (Toll-free: 1-800-331-4331).

If NHTSA receives similar complaints, it may open an investigation, and if it finds that a safety defect exists in a group of vehicles, it may order a recall and remedy campaign. However, NHTSA cannot become involved in individual problems between you, your dealer, or Toyota Motor Sales, U.S.A., Inc.

To contact NHTSA, you may call the Vehicle Safety Hotline toll-free at 1-888-327-4236 (TTY: 1-800-424-9153); go to <http://www.safercar.gov>, or write to: Administrator, NHTSA, 1200 New Jersey Ave, S.E., Washington, DC 20590. You can also obtain other information about motor vehicle safety from <http://www.safercar.gov>.

Seat belt instructions for Canadian owners (in French)

The following is a French explanation of seat belt instructions extracted from the seat belt section in this manual.

See the seat belt section for more detailed seat belt instructions in English.

Utilisation adéquate des ceintures de sécurité

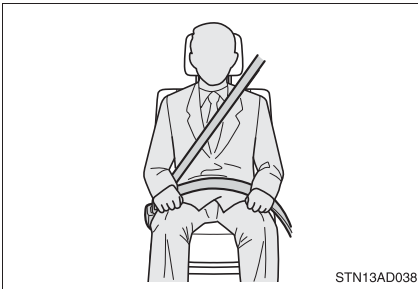

- Tirez sur la ceinture épaulière jusqu'à ce qu'elle recouvre entièrement l'épaule; elle ne doit cependant pas toucher le cou ni glisser de l'épaule.
- Placez la sangle abdominale de la ceinture de sécurité le plus bas possible sur les hanches.
- Réglez la position du dossier du siège. Tenez-vous assis dans le fond du siège, le dos droit.
- Ne tournez pas la ceinture de sécurité.

! ATTENTION

■ **Lorsque vous utilisez la ceinture de sécurité du siège central de troisième rangée**

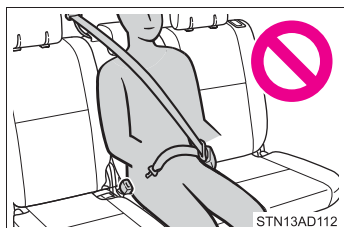

Ne pas utiliser la ceinture de sécurité du siège central de troisième rangée sans que ses deux boucles ne soient attachées. Fixer une seule boucle pourrait occasionner des blessures graves, voire mortelles, en cas de freinage brusque ou de collision.

Guide des ceintures de sécurité (siège central de troisième rangée)

Si la ceinture épaulière est trop près du cou d'une personne, utilisez le guide de la ceinture de sécurité.

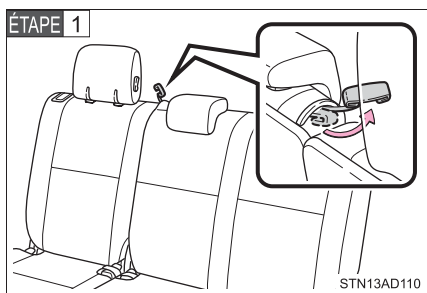

Retirez le guide de la pochette.

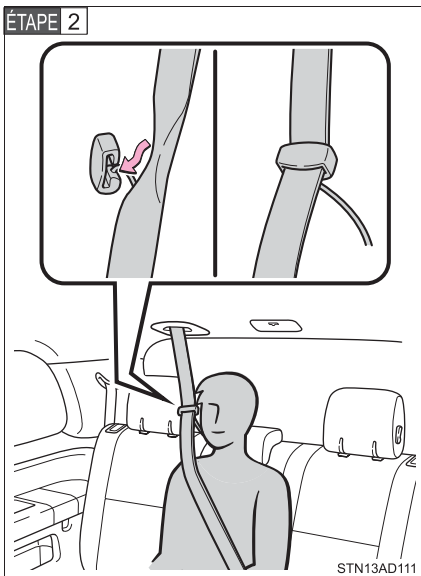

Faites glisser la ceinture au-delà de la fente du guide.

L'élastique doit être placé derrière la ceinture de sécurité.

Entretien et soins

■ Ceintures de sécurité

Avec un tissu ou une éponge, nettoyez à l'aide d'un savon doux et de l'eau tiède. Vérifiez aussi les ceintures régulièrement pour vous assurer qu'elles ne présentent pas d'usure excessive, d'effilochage ou de coupures.

⚠ ATTENTION

■ Dommages et usure de la ceinture de sécurité

Vérifiez périodiquement le système de ceintures de sécurité. Assurez-vous qu'il n'y a pas de coupures, d'effilochures ni de pièces desserrées. N'utilisez pas une ceinture de sécurité endommagée avant qu'elle soit remplacée. Une ceinture de sécurité endommagée ne peut pas protéger les occupants contre les blessures.

The following is a French explanation of SRS airbag instructions extracted from the SRS airbag section in this manual.

See the SRS airbag section for more detailed SRS airbag instructions in English.

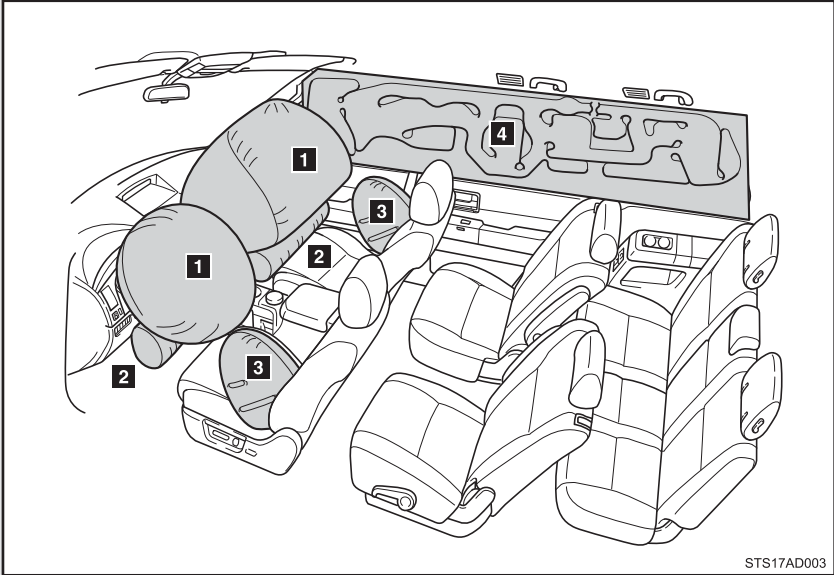

► Coussins gonflables avant SRS

1 Coussin gonflable SRS du conducteur/du passager avant
Peut protéger la tête et la poitrine du conducteur et du passager avant contre les impacts avec des composants intérieurs.

2 Coussins gonflables SRS de protection des genoux
Peuvent protéger le conducteur et le passager avant.

► Coussins gonflables SRS latéraux et coussins gonflables en rideau

3 Coussins gonflables SRS latéraux
Peuvent protéger le torse des occupants des sièges avant.

4 Coussins gonflables SRS en rideau

- Peuvent surtout protéger la tête des occupants des places extérieures.
- Peuvent empêcher les occupants d'être éjectés du véhicule en cas de retournement de celui-ci

Composants du système de coussins gonflables

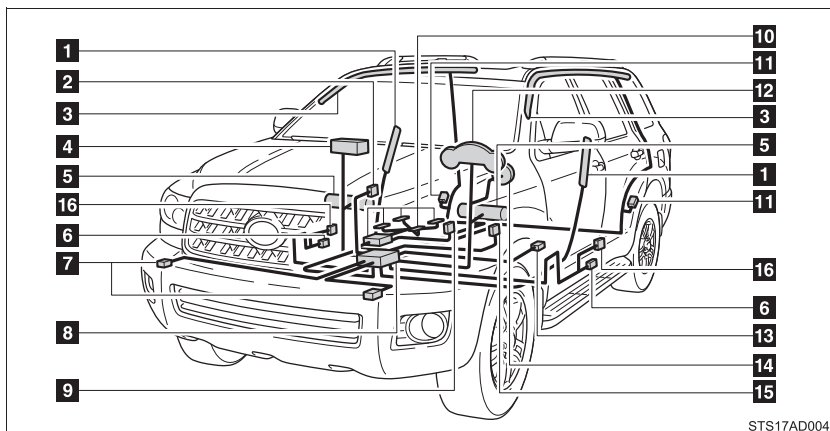

- | | |
|--|---|
| 1 Coussins gonflables latéraux | 7 Capteurs de coussin gonflable avant |
| 2 Lampes témoins AIR BAG ON et AIR BAG OFF | 8 Module de capteur de coussin gonflable |
| 3 Coussins gonflables rideaux | 9 Contacteur de boucle de ceinture de sécurité du passager avant |
| 4 Coussin gonflable du passager avant | 10 Système de classification d'occupant du siège passager avant (ECU et capteurs) |
| 5 Coussins gonflables de protection des genoux | |
| 6 Capteurs de coussin gonflable rideau et latéraux | |

- | | |
|--|--|
| 11 Capteurs de coussin gonflable rideau | 15 Contacteur de boucle de ceinture de sécurité du conducteur |
| 12 Témoin d'alerte SRS | |
| 13 Capteur de position de siège du conducteur | 16 Prétensionneurs et limiteurs d'effort de ceintures de sécurité |
| 14 Coussin gonflable du conducteur | |

Votre véhicule est équipé de COUSSINS GONFLABLES ÉVOLUÉS, dont la conception est basée sur les normes de sécurité des véhicules automobiles américains (FMVSS208). Le boîtier électronique de coussins gonflables (ECU) utilise les informations reçues des capteurs, etc. détaillés dans le schéma ci-dessus de composition du système pour commander le déploiement des coussins gonflables. Ces informations comprennent des informations sur la gravité de la collision et les occupants. Le déploiement rapide des coussins gonflables est obtenu au moyen d'une réaction chimique dans les dispositifs pyrotechniques, qui produit un gaz inoffensif permettant d'amortir le mouvement des occupants.

ATTENTION

■ Précautions relatives aux coussins gonflables SRS

Observez les précautions suivantes en ce qui concerne les coussins gonflables.

Les négliger pourrait occasionner des blessures graves, voire mortelles.

- Le conducteur et tous les passagers du véhicule doivent porter leur ceinture de sécurité de la manière appropriée.

Les coussins gonflables SRS sont des dispositifs supplémentaires qui doivent être utilisés de concert avec les ceintures de sécurité.

- Le coussin gonflable SRS du conducteur se déploie avec une force considérable et peut occasionner des blessures graves, voire mortelles, notamment lorsque le conducteur se trouve très près du coussin gonflable. La National Highway Traffic Safety Administration ("NHTSA") donne les recommandations suivantes:

Comme la zone à risque d'un coussin gonflable côté conducteur couvre 2 - 3 in. (50 - 75 mm) de la zone de déploiement du coussin gonflable, restez à 10 in. (250 mm) du coussin gonflable pour assurer une marge de sécurité suffisante. Cette distance est mesurée depuis le centre du volant jusqu'à votre sternum. Si vous vous tenez à moins de 10 in. (250 mm), vous pouvez changer votre position de conduite de plusieurs manières:

- Reculez votre siège à la position maximale vous permettant d'atteindre encore aisément les pédales.
- Inclinez légèrement le dossier du siège.

Même si les véhicules sont conçus différemment, la plupart des conducteurs peuvent maintenir une distance de 10 in. (250 mm), même si le siège se trouve complètement vers l'avant, simplement en inclinant un peu le dossier du siège vers l'arrière. Si la visibilité avant est moindre après avoir incliné le dossier du siège, utilisez un coussin ferme et non glissant pour être assis plus haut ou relevez l'assise du siège si cette option est disponible sur votre véhicule.

- Si votre volant est réglable en hauteur, inclinez-le vers le bas. Cela vous permet d'orienter le coussin gonflable vers votre buste plutôt que vers la tête et le cou.

Le siège doit être réglé de la manière recommandée ci-dessus par la NHTSA, tout en gardant le contrôle des pédales et du volant et la vue des commandes et des instruments.

ATTENTION

■ Précautions relatives aux coussins gonflables SRS

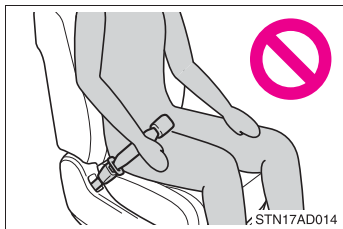

- Si vous attachez une rallonge de ceinture de sécurité aux boucles des ceintures de sièges avant, mais pas au pêne de la ceinture de sécurité proprement dite, les coussins gonflables SRS frontaux déterminent que le conducteur et le passager avant portent leur ceinture de sécurité, alors même qu'elle n'est pas attachée. Dans ce cas, les coussins gonflables SRS frontaux risquent de ne pas se déployer correctement en cas de collision, causant des blessures graves, voire mortelles. Veillez à porter la ceinture de sécurité avec la rallonge de ceinture de sécurité.
- Le coussin gonflable SRS du passager avant se déploie également avec une force considérable et peut occasionner des blessures graves, voire mortelles, notamment lorsque le passager avant se trouve très près du coussin gonflable. Le siège du passager avant doit se trouver le plus loin possible du coussin gonflable et le dossier doit être réglé de manière à ce que le passager avant soit assis bien droit.
- Le déploiement d'un coussin gonflable risque d'infliger des blessures graves, voire mortelles, aux bébés et aux enfants mal assis et/ou mal attachés. Un bébé ou un enfant trop petit pour utiliser une ceinture de sécurité doit être correctement retenu à l'aide d'un dispositif de retenue pour enfants. Toyota recommande vivement de placer et d'attacher correctement tous les bébés et enfants sur les sièges arrière du véhicule à l'aide de systèmes de retenue adaptés. Les sièges arrière constituent en effet l'endroit le plus sûr pour eux.

ATTENTION

■ Précautions relatives aux coussins gonflables SRS

- N'installez jamais un dispositif de retenue pour enfants de type dos à la route sur le siège du passager avant, même si le voyant AIR BAG OFF est allumé.

En cas d'accident, la force et la vitesse de déploiement du coussin gonflable du passager avant sont telles qu'elles pourraient infliger à l'enfant des blessures graves, voire mortelles, si le dispositif de retenue pour enfants du type dos à la route était installé sur le siège du passager avant.

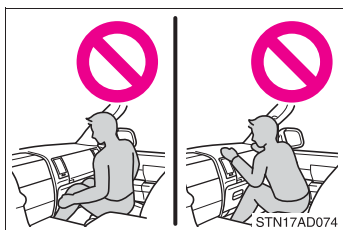

- Ne vous asseyez pas sur le bord du siège et ne vous appuyez pas sur le tableau de bord.

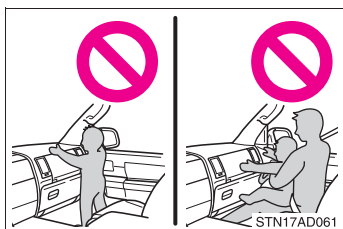

- Ne laissez pas un enfant se tenir face au coussin gonflable SRS du passager avant ou s'asseoir sur les genoux d'un passager avant.

- Ne conduisez pas le véhicule si vous ou le passager avez quelque chose sur les genoux.



- Ne vous appuyez pas sur la portière ou sur le longeron du toit, ni sur les montants avant, latéraux ou arrière.

ATTENTION

■ Précautions relatives aux coussins gonflables SRS

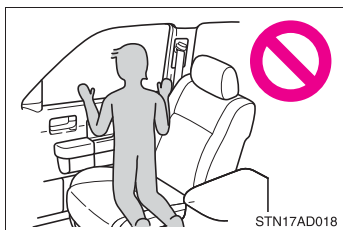

- Ne laissez personne s'agenouiller face à la portière sur le siège du passager ou sortir la tête ou les mains à l'extérieur du véhicule.

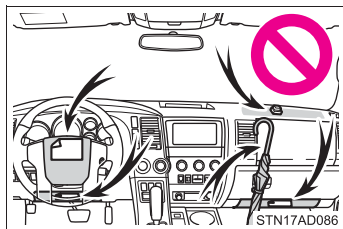

- Ne fixez et n'appuyez rien sur le tableau de bord, le tampon de volant ou la partie inférieure du bloc d'instrumentation.
Ces objets peuvent se transformer en projectiles lorsque les coussins gonflables SRS du conducteur, du passager avant ou de protection des genoux se déploient.



- Ne fixez rien sur les portières, le pare-brise, les vitres latérales, les montants avant et arrière, le longeron du toit ou la poignée de maintien.
- N'accrochez pas de cintres ni d'autres objets rigides sur les crochets porte-vêtements. Tous ces objets pourraient se transformer en projectiles et vous occasionner des blessures graves, voire mortelles, en cas de déploiement du coussin gonflable SRS rideau.

ATTENTION

■ Précautions relatives aux coussins gonflables SRS

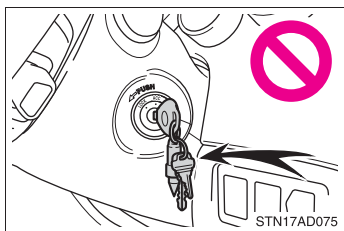

● N'accrochez pas d'objets lourds, aiguisés ou durs, par exemple des clés ou des accessoires, à la clé. Ces objets pourraient empêcher le déploiement du coussin SRS de protection des genoux ou être projetés dangereusement sur le siège du conducteur par la force du déploiement, et donc vous mettre en danger.

- Si le recouvrement de vinyle est placé sur la zone de déploiement des coussins gonflables SRS de protection des genoux, veuillez à le retirer.
- N'utilisez pas d'accessoires recouvrant les parties du siège où les coussins gonflables SRS latéraux se déploient, car ceux-ci pourraient nuire au déploiement de ces coussins gonflables SRS.
- Ne frappez pas et n'appliquez pas une pression importante à l'emplacement des composants de coussins gonflables SRS. Ces actions peuvent entraîner un mauvais fonctionnement des coussins gonflables SRS.
- Ne touchez à aucun composant des coussins gonflables SRS immédiatement après leur déploiement (gonflage), car ils pourraient être chauds.
- Si vous avez de la difficulté à respirer après le déploiement d'un coussin gonflable SRS, ouvrez une portière ou une vitre pour laisser entrer l'air, ou quittez le véhicule si vous pouvez le faire en toute sécurité. Dès que possible, nettoyez tous les résidus afin d'éviter les irritations cutanées.
- Si les emplacements de stockage des coussins gonflables SRS, notamment le tampon de volant et les garnitures des montants avant et arrière, sont endommagés ou fissurés, faites-les remplacer par votre concessionnaire Toyota.

ATTENTION

■ **Modification et mise au rebut des composants du système de coussins gonflables SRS**

Ne mettez pas le véhicule au rebut et n'effectuez aucune des modifications suivantes sans d'abord consulter votre concessionnaire Toyota.

Les coussins gonflables SRS pourraient fonctionner de manière incorrecte ou se déployer (gonfler) accidentellement, ce qui serait susceptible d'occasionner des blessures graves, voire mortelles.

- Installation, retrait, démontage et réparation des coussins gonflables SRS.
- Réparations, modifications, retrait ou remplacement du volant, du bloc d'instrumentation, du tableau de bord, des sièges ou du capitonnage des sièges, des montants avant, latéraux ou arrière et du longeron du toit.
- Réparations ou modifications de l'aile ou du pare-choc avant, ou du côté de l'habitacle.
- Installation d'un équipement de protection sur la calandre (pare-buffle, pare-kangourou, etc.), d'un chasse-neige, d'un treuil ou d'une galerie de pavillon.
- Modifications au système de suspension du véhicule.
- Installation d'appareils électroniques tels qu'un radio bidirectionnelle ou un lecteur de CD.
- Modifications à votre véhicule pour une personne aux capacités physiques réduites.

Index

Abbreviation list	560
Alphabetical index.....	562
What to do if...	573

For vehicles with Entune Audio Plus or Entune Premium Audio, refer to the “NAVIGATION SYSTEM OWNER’S MANUAL” for information regarding the multimedia system.

Multimedia system types: →P. 310

Abbreviation/Acronym list

ABBREVIATIONS	MEANING
2WD	Two Wheel Drive
4WD	Four Wheel Drive
ABS	Anti-Lock Brake System
ACC	Accessory
AI-SHIFT	Artificial Intelligence shifting
ALR	Automatic Locking Retractor
A-TRAC	Active Traction Control
AUTO LSD	Automatic Limited Slip Differential
AVS	Adaptive Variable Suspension System
BSM	Blind Spot Monitor
CRS	Child Restraint System
ECU	Electronic Control Unit
EDR	Event Data Recorder
ELR	Emergency Locking Retractor
FFV	Flexible Fuel Vehicle
GAWR	Gross Axle Weight Rating
GCWR	Gross Combination Weight Rating
GVWR	Gross Vehicle Weight Rating
I/M	Emission inspection and maintenance
INFO	Information
LATCH	Lower Anchors and Tethers for Children
LED	Light Emitting Diode
LT	Light truck
M + S	Mud + Snow
MMT	Methylcyclopentadienyl Manganese Tricarbonyl
MTBE	Methyl Tertiary Butyl Ether
OBD	On Board Diagnostics

ABBREVIATIONS	MEANING
PWR	Power
SRS	Supplemental Restraint System
TIN	Tire Identification Number
TPMS	Tire Pressure Warning System
TRAC	Traction Control
TWI	Treadwear indicators
TWR	Trailer Weight Rating
VIN	Vehicle Identification Number
VSC	Vehicle Stability Control

A	<p>A/C.....294, 303</p> <p>AAC disc*</p> <p>ABS246</p> <p>Active traction control.....246</p> <p>Adaptive variable suspension system238</p> <p>Air conditioning filter.....430</p> <p>Air conditioning system</p> <p> Air conditioning filter.....430</p> <p> Front air conditioning system294</p> <p> Rear air conditioning system303</p> <p>Airbags</p> <p> Airbag operating conditions.....115</p> <p> Airbag precautions for your child119</p> <p> Airbag warning light.....470</p> <p> Curtain shield airbag operating conditions.....115</p> <p> Curtain shield airbag precautions119</p> <p> Front passenger occupant classification system124</p> <p> General airbag precautions119</p> <p> Locations of airbags112</p> <p> Modification and disposal of airbags123</p> <p> Proper driving posture.....110, 119</p> <p> Side airbag operating conditions.....115</p> <p> Side airbag precautions119</p> <p> SRS airbags112</p>	<p>Alarm.....107</p> <p>Antenna*</p> <p>Anti-lock brake system246</p> <p>Armrest.....359</p> <p>Ashtrays345</p> <p>Assist grips362</p> <p>A-TRAC246</p> <p>Audio input.....311</p> <p>Audio system</p> <p> A/V input port*</p> <p> Antenna*</p> <p> Audio input311</p> <p> Audio visual input*</p> <p> AUX port312</p> <p> Blu-ray Disc™*</p> <p> CD player*</p> <p> DVD disc*</p> <p> DVD player*</p> <p> iPod*</p> <p> MP3/WMA/AAC disc*</p> <p> Portable music player*</p> <p> Radio*</p> <p> Rear seat entertainment system*</p> <p> Steering wheel audio switch*</p> <p> Type310</p> <p> USB memory*</p> <p>Audio visual input*</p> <p>AUTO LSD system244</p> <p>Automatic light control system192</p> <p>Automatic transmission161</p> <p>AUX port311</p> <p>Auxiliary box338</p> <p>A/V input port*</p> <p>AVS238</p>
----------	---	--

B	Back-up lights	
	Replacing light bulbs	447
	Wattage	522
	Back door	
	Back door	40
	Back window	93
	Wireless remote control.....	31
	Battery	
	Checking	410
	If the vehicle has discharged battery	501
	Preparing and checking before winter	266
	Blind Spot Monitor	227
	Bluetooth® audio*	
	Bluetooth® phone*	
	Bottle holder	337
	Brake assist	246
	Brakes	
	Fluid.....	407
	Parking brake	166
	Break-in tips	149
	BSM	227
C	Card holder	323
	Care	
	Exterior	382
	Interior	385
	Seat belts	386
	Cargo capacity	259
	Cargo hooks	366
	CD player*	
	Chains	266
	Child restraint system	
	Booster seats, definition	129
	Booster seats, installation	140
	Convertible seats, definition.....	129
	Convertible seats, installation	139

	Front passenger occupant classification system	124
	Infant seats, definition	129
	Infant seats, installation.....	138
	Installing CRS with LATCH system	135
	Installing CRS with seat belts	138
	Installing CRS with top tether straps.....	141
	Child safety	
	Airbag precautions	119
	Battery precautions	411, 503
	Child restraint system.....	129
	Child-protectors.....	37
	How your child should wear the seat belt	75
	Installing child restraints.....	133
	Moon roof precautions	99
	Power window lock switch.....	90
	Power window precautions	92
	Removed key battery precautions	434
	Seat belt extender precautions	78
	Seat belt precautions	75
	Seat heater precautions	356
	Child-protectors	37
	Cigarette lighter	346
	Cleaning	
	Exterior.....	382
	Interior	385
	Seat belts	386
	Climate control seat	357
	Clock	342
	Coin holder	319
	Compass	376
	Condenser	407
	Console box	320, 328
	Conversation mirror	347

*: Refer to “NAVIGATION SYSTEM OWNER’S MANUAL”.

D

Cooling system
 Engine overheating504

CRS129

Cruise control
 Cruise control202
 Dynamic laser cruise control206

Cup holders333

Curtain shield airbags112

Customizable features.....539

Daytime running light system191

Defogger
 Rear window307
 Side mirrors307

Dimension.....512

Dinghy towing290

Display
 Trip information178
 Warning message480

Do-it-yourself maintenance.....395

Door courtesy lights
 Door courtesy lights313
 Wattage522

Doors
 Back door40
 Door glasses90
 Door lock31, 35
 Side doors35
 Side mirrors84

Driver's seat belt reminder light471

Driving
 Break-in tips149
 Correct posture110
 Procedures148
 Winter driving tips266

Driving position memory.....62

DVD player*

E

Electronically modulated air suspension233

Emergency flashers
 Switch460

Emergency, in case of
 If the engine will not start497
 If the shift lever cannot be shifted from P499
 If the vehicle has discharged battery501
 If the warning buzzer sounds469
 If the warning light turns on469
 If the warning message is displayed480
 If you have a flat tire486
 If you lose your keys500
 If you think something is wrong467
 If your vehicle becomes stuck507
 If your vehicle has to be stopped in an emergency509
 If your vehicle needs to be towed461
 If your vehicle overheats504

Engine
 Compartment..... 400
 Engine switch 158
 Hood..... 399
 How to start the
 engine 158
 Identification number 514
 If the engine will not start..... 497
 Ignition switch 158
 Overheating..... 504
Engine coolant
 Capacity 517
 Checking 405
 Preparing and checking
 before winter 266
**Engine coolant temperature
 gauge 168**
Engine immobilizer system.... 105
Engine oil
 Capacity 516
 Checking 401
 Preparing and checking
 before winter 266
Engine switch 158
Event data recorder 25

F **FFV100, 523**
Flex-fuel100, 523
Flexible fuel vehicle100, 523
Floor mat.....363
Fluid
 Brake407
 Washer.....413
Fog lights
 Replacing light bulbs447
 Switch.....193
 Wattage522
Four-wheel drive system.....239
**Front air conditioning
 system294**
**Front passenger occupant
 classification system124**
**Front passenger’s seat belt
 reminder light.....471**
Front seats
 Adjustment48
Front side marker lights
 Replacing light bulbs447
 Switch.....187
 Wattage522
Front turn signal lights
 Replacing light bulbs447
 Wattage522
Fuel
 Capacity515
 Fuel gauge168
 Fuel pump shut off system468
 Gas station information576
 Information523
 Refueling100
 Type515
Fuel filler door100
Fuel pump shut off system468
Fuses.....435

*: Refer to “NAVIGATION SYSTEM OWNER’S MANUAL”.

G	Garage door opener	370
	Gas station information	576
	Gauges	168
	Glove box	318
H	Hands-free system (for cellular phone)*	
	Hazard lights	
	Switch.....	460
	Head restraints	
	Adjusting	65
	Headlight cleaner	201
	Headlights	
	Replacing light bulbs	447
	Switch.....	187
	Wattage.....	522
	Heaters	
	Seat heaters.....	354, 357
	Side mirror.....	307
	Height control	
	Electronically modulated air suspension.....	233
	Hood	399
	Hooks	
	Cargo net	366
	Shopping bag.....	367
	Horn	167

I	I/M test	394
	Identification	
	Engine.....	514
	Vehicle	514
	Ignition switch	158
	Illuminated entry system	313
	Indicator lights	173
	Initialization	
	Items to initialize	543
	Inside rear view mirror	81
	Interior lights	
	Interior lights	313
	Switch	314
	Wattage.....	522
	Instrument panel light control	172
	Intuitive parking assist	220
J	Jack	
	Positioning the jack	489
	Vehicle-equipped jack.....	486
	Jack handle	486
K	Keyless entry	31
	Keys	
	Engine switch.....	158
	If you lose your keys	500
	Ignition switch	158
	Key number.....	30
	Keyless entry	31
	Keys	30
	Wireless remote control key	31

L	LATCH system	135
	License plate lights	
	Replacing light bulbs	447
	Wattage	522
	Light bulbs	
	Replacing	447
	Wattage	522
	Lights	
	Door courtesy lights.....	313
	Emergency flasher switch	460
	Fog light switch.....	193
	Hazard light switch	460
	Headlight switch	187
	Interior light switch.....	315, 316
	Outer foot lights	313
	Personal light switch.....	315
	Replacing light bulbs	447
	Turn signal lever.....	165
	Vanity lights	341
	Wattage	522
	Load capacity	264
	Lock steering column	159
	Luggage compartment	
	features	365

M	Maintenance	
	Do-it-yourself	
	maintenance	395
	General maintenance.....	391
	Maintenance data.....	512
	Maintenance requirements....	388
	Reset the maintenance	
	data	389
	Map holder	324
	Meter	
	Accessory meter	184
	Instrument panel light	
	control	172
	Meters	168
	Mirrors	
	Conversation mirror.....	347
	Inside rear view mirror.....	81
	Side mirror heaters.....	307
	Side mirrors.....	84
	Vanity mirrors	341
	Moon roof	96
	MP3 disc *	
	Multi-information	
	display	178

*: Refer to “NAVIGATION SYSTEM OWNER’S MANUAL”.

N	Noise from under vehicle	23
O	Odometer	168
	Off-road precautions	254
	Oil	
	Engine oil	401
	Opener	
	Back door	40
	Fuel filler door	100
	Hood.....	399
	Outside rear view mirror	
	indicator	227
	Outside rear view mirrors	
	Adjusting and folding.....	84
	Indicator	227
	Outside temperature	
	display	343
	Overhead console.....	331
	Overheating, Engine	504

P	Parking assist	220
	Parking brake	166
	Parking lights	
	Replacing light bulbs.....	447
	Switch	187
	Wattage.....	522
	Pen holder	326
	Personal lights	
	Switch	315
	Wattage.....	522
	Power back door.....	41
	Power back window.....	93
	Power outlet	348
	Power windows.....	90

R	Radiator	407
	Radio *	
	Rear air conditioning system	303
	Rear console box	328
	Rear seat	
	Adjustment	51
	Folding down second seatback.....	55
	Folding down third seatback.....	57
	Rear seat entertainment system *	
	Rear seat entertainment system controller battery *	
	Rear side sunshade	360
	Rear turn signal lights	
	Replacing light bulbs	447
	Wattage	522
	Rear view mirror	
	Anti-glare	81, 86
	Compass	376
	Indicator.....	227
	Rear view monitor system *	
	Rear window defogger	307
	Rear window wiper	199
	Replacing	
	Fuses.....	435
	Key battery	433
	Light bulbs	447
	Tires	486
	Reporting safety defects for U.S. owners	546
	Resetting the maintenance required reminder light	389
	Resetting the message indicating maintenance is required	389
	Roof luggage carrier	88

S	Seat belts	
	Adjusting the seat belt.....	69
	ALR	74
	Automatic Locking Retractor	74
	Child restraint system installation.....	133
	Cleaning and maintaining the seat belts	386
	Comfort guide.....	72
	ELR	74
	Emergency Locking Retractor	74
	How to wear your seat belt.....	69
	How your child should wear the seat belt	75
	Pregnant women, proper seat belt use	74
	Reminder light.....	471
	Seat belt extenders	75
	Seat belt pretensioners	73
	Seat heaters	354
	Seating capacity	264
	Seats	
	Adjustment	48, 51
	Adjustment precaution	50, 61
	Child seats/child restraint system installation	133
	Cleaning	385
	Climate control seat	357
	Driver's seat position memory	62
	Head restraint.....	65
	Properly sitting in the seat.....	110
	Seat heaters.....	354, 357
	Seat heaters and ventilators	357

*: Refer to "NAVIGATION SYSTEM OWNER'S MANUAL".

Service reminder indicators 173

Shift lever

- Automatic transmission..... 161
- If the shift lever cannot be shifted from P..... 499

Shift lock system 499

Shopping bag hooks 367

Side airbags..... 112

Side marker lights

- Replacing 447
- Switch..... 187
- Wattage..... 522

Side mirrors

- Adjusting and folding..... 84

Spare tire

- Inflation pressure..... 521
- Storage location 486

Spark plug 518

Specifications..... 512

Speedometer 168

Steering

- Column lock release..... 79

Steering wheel

- Adjustment 79, 80
- Audio switches*
- Steering wheel memory 62
- Telephone switches*

Stop lights

- Replacing light bulbs..... 447
- Wattage..... 522

Storage feature 317

Storage precautions 261

Stuck

- If your vehicle becomes stuck 507

Sun visors 340

Sunshade..... 360

Switch

- BSM main switch 227
- Emergency flasher switch 460
- Engine switch..... 158
- Fog light switch 193
- Hazard light switch..... 460
- Ignition switch 158
- Light switches 187
- Power back door switch 31, 41
- Power back window switch 93
- Power door lock switch 35
- Power window switch..... 90
- Rear window wiper and washer switch..... 199
- Seatback folding/returning switch..... 54, 60
- Window lock switch..... 90
- Wiper and washer switch..... 195, 199

T	Tachometer	168
	Tail lights	
	Replacing light bulbs	447
	Switch	187
	Wattage	522
	Talk switch*	
	Telephone switch*	
	Theft deterrent system	
	Alarm	107
	Engine immobilizer system...	105
	Tire inflation pressure	423
	Tire information	
	Glossary	533
	Size	530
	Tire identification number	529
	Uniform tire quality grading	531
	Tires	
	Chains	267
	Checking	415
	If you have a flat tire	486
	Inflation pressure	423, 521
	Information	528
	Replacing	486
	Rotating tires	416
	Size	521
	Snow tires	266
	Tire pressure warning system	416, 472

	Tissue pocket	327
	Tools	486
	Total load capacity	264
	Towing	
	Dinghy towing	290
	Emergency towing	461
	Trailer towing	270
	Trailer weight rating	272, 513
	Traction control	246
	TRAC	246
	Trip information	178
	Trip meter	168
	Turn signal lights	
	Replacing light bulbs	447
	Switch	165
	Wattage	522
V	Valet key	30
	Vanity lights	
	Vanity lights	341
	Wattage	522
	Vanity mirrors	341
	Vehicle data recordings	24
	Vehicle identification	
	number	514
	Vehicle stability control	246
	VSC	246

*: Refer to “NAVIGATION SYSTEM OWNER’S MANUAL”.

W

Warning buzzers
 Brake system469
 Open door471
 Seat belt reminder.....471

Warning lights
 ABS470
 Airbag system470
 Anti-lock brake system.....470
 Brake assist system470
 Brake system469
 Charging system469
 Electronic engine control
 system470
 Malfunction indicator lamp470
 Master warning light.....474
 Open door471
 Pretensioners470
 Seat belt reminder light471
 SRS airbags470
 Tire pressure warning light....472

Warning messages480

Washer
 Checking413
 Preparing and checking
 before winter266
 Switch.....195, 199

Washing and waxing382

Weight
 Cargo capacity259
 Load limits.....264
 Towing capacity513
 Trailer Weight Rating275, 513
 TWR.....275, 513
 Vehicle capacity weight.....513
 Weight.....513

Wheels427

Window glasses90, 93

Window lock switch.....90

Windows
 Power back window93
 Power windows90
 Rear window defogger307
 Washer.....195, 199

Windshield wiper de-icer309

Windshield wipers195

Wireless remote control key
 Replacing the battery433
 Wireless remote control31

WMA disc*

What to do if...

What to do if...

A tire punctures

P. 486 If you have a flat tire

The engine does not start

P. 497 If the engine will not start

P. 105 Engine immobilizer system

P. 501 If the vehicle battery is discharged

The shift lever cannot be moved out

P. 499 If the shift lever cannot be shifted from P

The engine coolant temperature gauge enters the red zone

P. 504 If your vehicle overheats

Steam can be seen coming from under the hood

The key is lost

P. 500 If you lose your keys

The battery runs out

P. 501 If the vehicle battery is discharged

The doors cannot be locked

P. 35 Side doors

P. 40 Back door

The horn begins to sound.

P. 107 Alarm

The vehicle is stuck in mud or sand

P. 507 If the vehicle becomes stuck

The warning light or indicator light comes on

P. 469 If a warning light turns on

■ Instrument cluster

▶ Vehicles with multi-information display

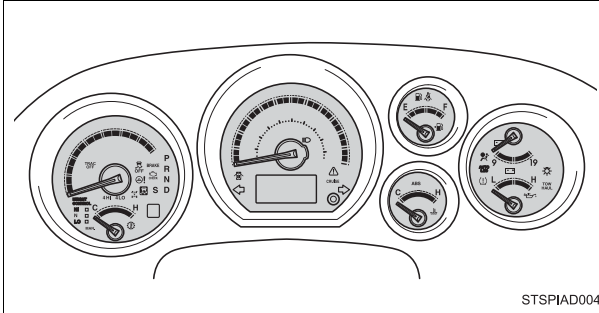

▶ Vehicles without multi-information display

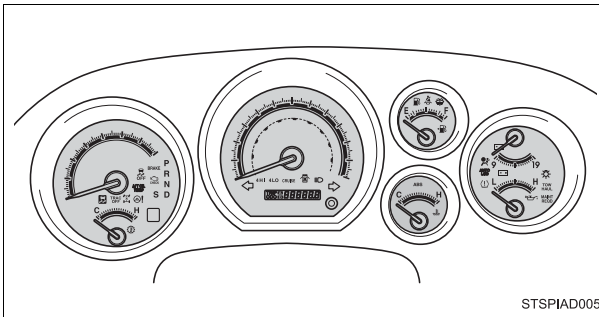

■ Center panel

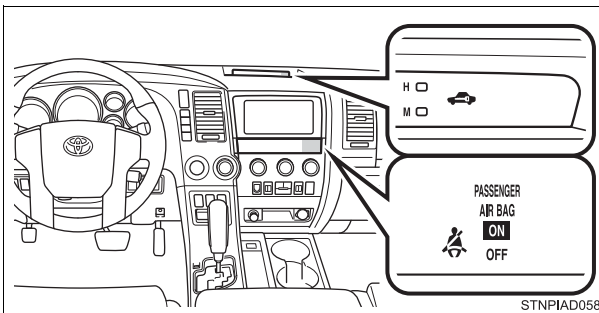



■ Warning lights

BRAKE Brake system warning light

or

 P. 469

 Charging system warning light P. 469

 Malfunction indicator lamp

or

 P. 470

ABS ABS warning light

or

 P. 470

MAINT REQD Maintenance required reminder light P. 473

 SRS warning light P. 470

A/T OIL TEMP Automatic transmission fluid temperature warning light P. 472

 Low washer fluid warning light P. 473

 Power steering warning light P. 470

 Master warning light P. 474

 Slip indicator P. 470

 Tire pressure warning light P. 472

 Open door warning light P. 471

 Low fuel level warning light P. 473

 Driver's seat belt reminder light P. 471

PASSENGER
 Front passenger's seat belt reminder light P. 471

The warning message is displayed

P. 480 If a warning message is displayed

GAS STATION INFORMATION

Auxiliary catch lever

P. 399

Fuel filler door

P. 100

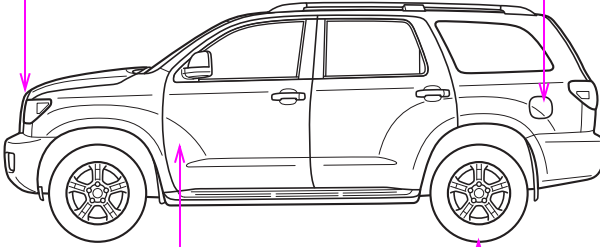

Hood lock release lever

P. 399

Tire inflation pressure

P. 521

STNPIAD002

Fuel tank capacity (Reference)	26.4 gal. (100.0 L, 22.0 Imp.gal.)	
Fuel type	P. 515	
Cold tire inflation pressure	P. 521	
Engine oil capacity (Drain and refill-reference)	With filter	qt. (L, Imp.qt.) 7.9 (7.5, 6.6)
	Without filter	7.5 (7.1, 6.2)
Engine oil type	P. 516	