

**2002
VOLVO
C70 Coupe & Convertible**

This manual deals with the operation and care of your Volvo.

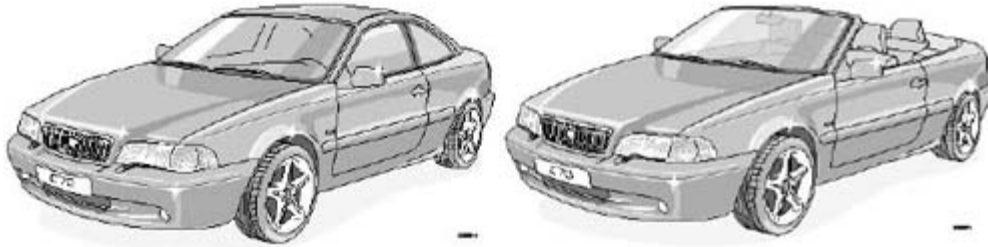

Welcome to the world-wide family of Volvo owners. We trust that you will enjoy many years of safe driving in your Volvo, an automobile designed with your safety and comfort in mind. To help ensure your satisfaction with this vehicle, we encourage you to familiarize yourself with the equipment descriptions, operating instructions and maintenance requirements/recommendations in this manual. We also urge you and your passengers to wear seat belts at all times in this (or any other) automobile. And, of course, please do not operate a vehicle if you may be affected by alcohol, medication or any impairment that could hinder your ability to drive.

Your Volvo is designed to meet all applicable safety and emission standards, as evidenced by the certification labels attached to the driver's door opening and on the left wheel housing in the engine compartment.

For further information please contact your retailer, or:

In the USA:

Volvo Cars of North America

Customer Relations

P.O. Box 914

Rockleigh, New Jersey 07647-0914

800-458-1552

In Canada:

Volvo Canada Ltd.

175 Gordon Baker Road

Willowdale, Ontario M2H 2N7

800-663-8255

We also invite you to visit our Home Page on the Internet at:

<http://www.volvocars.com>

Contents

Contents

[Chapter 1 - Occupant safety](#)

[Chapter 2 - Instruments, switches and controls](#)

[Chapter 3 - Body and interior](#)

[Chapter 4 - Starting and driving](#)

[Chapter 5 - Wheels and tires](#)

[Chapter 6 - In case of an emergency](#)

[Chapter 7 - Car care](#)

[Chapter 8 - Volvo Service](#)

[Chapter 9 - Specifications](#)

[Chapter 10 - Audio systems](#)

[Homelink® Universal Transceiver \(option\)](#)

[Index](#)

[Back Cover](#)

NOTE: This manual contains information on the Volvo C70 Coupe and C70 Convertible. Unless otherwise stated, the information pertains to both models.

General information

Important

Before you operate your car for the first time, please familiarize yourself with the **BREAK-IN** information on [page 64](#). You should also be familiar with the information in the first three chapters of this manual.

Information contained in the balance of the manual is extremely useful and should be read after operating the vehicle for the first time.

The manual is structured so that it can be used for reference. For this reason, it should be kept in the car for ready access.

Do not export your Volvo to another country before investigating that country's applicable safety and exhaust emission requirements. In some cases it may be difficult or impossible to comply with these requirements. Modifications to the emission control system(s) may render your Volvo not certifiable for legal operation in the U.S., Canada and other countries.

All information, illustrations and specifications contained in this manual are based on the latest product information available at the time of publication. Please note that some vehicles may be equipped differently, depending on special legal requirements and that optional equipment described in this manual may not be available in all markets.

Volvo reserves the right to make model changes at any time, or to change specifications or design, without notice and without incurring obligation.

CAUTION: Certain models have reduced ground clearance due to the design of the front spoiler. Please observe caution when e.g., driving onto garage hoists, through drifted snow or when other road debris is encountered, or when parking near curbs.

© 2001 Volvo Cars of North America Inc.

Shiftlock (automatic transmission only)

When your car is parked, the gear selector is locked in the (P)ark position. To release the selector from this position, turn the ignition key to position II (or start the engine), depress the brake pedal, press the button on the front side of the gear selector and move the selector from (P)ark.

If it is necessary to manually override the shiftlock system:

- Turn the starting (ignition) key to position I
- Press firmly on the "SHIFTLOCK OVERRIDE" button located to the right of the base of the gear selector
- While holding the override button down, press the button on the front of the gear selector
- Move the selector from the (P)ark position.

Keylock (automatic transmission only)

This means that when you switch off the ignition, the gear selector must be in the (P)ark position before the starting (ignition) key can be removed from the ignition switch.

Clutch interlock (manual transmission only)

The clutch must be fully depressed before you can start your car. If the clutch is not depressed, it will not be possible to start the engine.

Anti-lock Brake System (ABS)

The ABS system in your car performs a self-diagnostic test when the vehicle first reaches the speed of approximately 12 mph (20 km/h). The brake pedal will pulsate several times and a sound may be audible from the ABS control module. This is normal.

Fuel tank cover

The fuel tank cover is locked and must be popped open using the control on the driver's door (see illustration on [page 16](#)).

Volvo and the environment

Volvo is committed to the well being of our customers. As a natural part of this commitment, we care about the environment in which we all live. Caring for the environment means an everyday involvement in reducing our

environmental impact.

Volvo's environmental activities are based on a holistic view, which means we consider the overall environmental impact of a product throughout its complete life cycle. In this context, design, production, product use, and recycling are all important considerations.

In production, Volvo has partly or completely phased out several chemicals including freons, lead chromates, naphthanates, asbestos, mercury and cadmium; and reduced the amount of chemicals used in our plants 50% since 1991.

In use, Volvo was the first in the world to introduce into production a three-way catalytic converter with a Lambda sond, now called oxygen sensor, in 1976. The current version of this highly efficient system reduces emissions of harmful substances (CO, HC, NOx) from the exhaust pipe by approximately 95% and the search to eliminate the remaining emissions continues. Volvo is the only automobile manufacturer to offer CFC-free retrofit kits for the air conditioning system for all models as far back as the M/Y 1975 240. Advanced electronic engine controls, refined purification systems and cleaner fuels are bringing us closer to our goal.

After Volvo cars and parts have fulfilled their use, recycling is the next critical step in completing the life cycle. The metal content is about 75% of the total weight of a car, which makes the car among the most recycled industrial products. In order to have efficient and well controlled recycling, many Volvo variants have printed dismantling manuals, indicating the weight and material of individual components. For Volvo, all homogeneous plastic parts weighing more than 1.7 oz. (50 grams) are marked with international symbols that indicate how the component is to be sorted for recycling.

In addition to continuous environmental refinement of conventional gasoline-powered internal combustion engines, Volvo is actively looking at advanced technology alternative-fuel vehicles.

When you drive a Volvo, you become our partner in the work to lessen the car's impact on the environment.

To reduce your vehicle's environmental impact, you can:

- Maintain proper air pressure in your tires. Tests have shown decreased fuel economy with improperly inflated tires
- Follow the recommended maintenance schedule
- Drive at a constant speed
- See an authorized Volvo retailer as soon as possible for inspection if the check engine (malfunction indicator) lamp illuminates, or stays on after the vehicle has started
- Properly dispose of any vehicle related waste such as used motor oil, used batteries, brake pads, etc.
- When cleaning your car, use Volvo's own car care products, all of which have systematically been adapted to the environment

For additional information regarding the environmental activities in

which Volvo Cars of North America, Inc. and Volvo Car Corporation are involved, visit our Internet Home Page at:

<http://www.volvocars.com>



[Top of Page](#)

**2002
VOLVO
C70 Coupe & Convertible**

Chapter 1 - Occupant safety

pg. 1 Occupant safety

Occupant safety

Not wearing a seat belt is like believing "It'll never happen to me!". Volvo, the inventor of the three-point seat belt, urges you and all adult occupants of your car to wear seat belts and ensure that children are properly restrained, using an infant, car or booster seat determined by age, weight and height. Volvo also believes no child should sit in the front seat of a car.

Fact: In every state and province, some type of child-restraint legislation has been passed. Additionally, most states and provinces have already made it mandatory for occupants of a car to use seat belts.

So, urging you to "buckle up" is not just our recommendation - legislation in your state or province may mandate seat belt usage. The few seconds it takes to buckle up may one day allow you to say, "It's a good thing I was wearing my seat belt".



[Seat belts](#) 2

[Volvo SRS](#) 4

[Side Impact Protection System - \(SIPS\) air bag](#) 8

[WHIPS](#) 9

[Roll Over Protection System \(ROPS\)](#) 10

[Child safety](#) 11

[Occupant safety](#) 14

[Reporting Safety Defects](#) 14

pg. 2 Seat belts

Seat belts

Always fasten the seat belts before you drive or ride.

Two lights above the rear view mirror will be illuminated for 4-8 seconds after the starting (ignition) key is turned to the driving position. A chime will sound at the same time if the driver has not fastened his seat belt. The rear seats are provided with self-retracting inertia reel belts. The front seats are provided with single roller belts with tensioners.

To buckle:

Pull the belt out far enough to insert the latch plate into the receptacle (buckle for rear seats) until a distinct snapping sound is heard. The seat belt retractor is normally "unlocked" and you can move freely, provided that the shoulder belt is not pulled out too far. The retractor will lock up as follows:

- if the belt is pulled out rapidly
- during braking and acceleration
- if the vehicle is leaning excessively
- when driving in turns

For the seat belt to provide maximum protection in the event of an accident, it must be worn correctly. When wearing the seat belt remember:

- The belt should not be twisted or turned.
- The lap belt must be positioned low on the hips (not pressing against the abdomen).

Make sure that the shoulder belt is rolled up into its retractor and that the shoulder and lap belts are taut. Before exiting the car, check that the seat belt retracts fully after being unbuckled. If necessary, guide the belt back into the retractor slot.

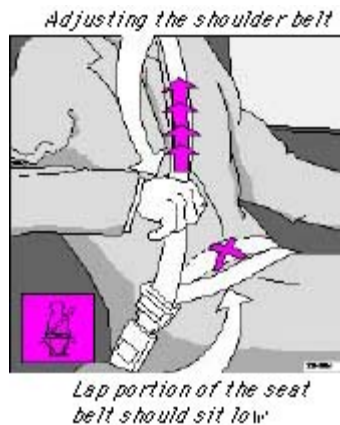

NOTE: Legislation in your state or province may mandate seat belt usage.

For information on securing child seats, please refer to [page 11](#).

WARNING!

The rear seat of the Volvo C70 is intended for two occupants only. Only two three-point seat belts are provided. The center position should never be used to seat a passenger.

WARNING!

· Any device used to induce slack into the shoulder belt portion of the three-point belt system will have a detrimental effect on the amount of protection available to you in the event of a collision. The seat back should not be tilted too far back. The shoulder belt must be taut in order to function properly.

· Do not use child safety seats or child booster cushions/backrests in the front passenger's seat. We also recommend that children who have outgrown these devices sit in the rear seat with the seat belt properly fastened.

pg. 3 Seat belts



During pregnancy

Pregnant women should always wear seat belts. Remember that the belt should always be positioned in such a way as to avoid any possible pressure on the abdomen. The lap portion of the belt should be located low, as shown in the above illustration.

WARNING!

- The rear seat of the Volvo C70 is intended for two occupants only. Only two three-point seat belts are provided. The center position should never be used to seat a passenger.
- Never use a seat belt for more than one occupant.
- Never wear the shoulder portion of the belt under the arm, behind the back or otherwise out of position. Such use could cause injury in the event of an accident.
- As the seat belts lose much of their strength when exposed to violent stretching, they should be replaced after any collision, even if they appear to be undamaged.
- Never repair the belt on your own; have this work done by an authorized Volvo retailer only.
- Any device used to induce slack into the shoulder belt portion of the three-point belt system will have a detrimental effect on the amount of protection available to you in the event of a collision.
- The seat back should not be tilted too far back. The shoulder belt must be taut in order to function properly.

pg. 4 Volvo SRS



As an enhancement to the three-point seat belt system, your Volvo is equipped with a Supplemental Restraint System (SRS). The Volvo SRS consists of an airbag (2) on both the driver's and passenger's sides and seat belt tensioners in both front door pillars (4). The system is designed to supplement the protection provided by the three-point seat belt system.

The SRS system is indicated by the "SRS" embossed on the steering wheel pad and above the glove compartment, and by decals on both sun visors and on the far right side of the dash.

The airbags are folded and located in the steering wheel hub and above the glove compartment. They are designed to deploy during certain frontal or front-angular collisions, impacts, or decelerations, depending on the crash severity, angle, speed and object impacted. The airbags may also deploy in certain non-frontal collisions where rapid deceleration occurs.

The airbag system includes gas generators (1) surrounded by the airbags (2) and front seat belt tensioners for both of the front seats (4). To deploy the system, the sensor (3) activates the gas generators causing the airbags to be inflated with nitrogen gas. As the movement of the seats' occupants compresses the airbags, some of the gas is expelled at a controlled rate to provide better cushioning. Both seat belt tensioners also deploy, minimizing any seat belt slack.

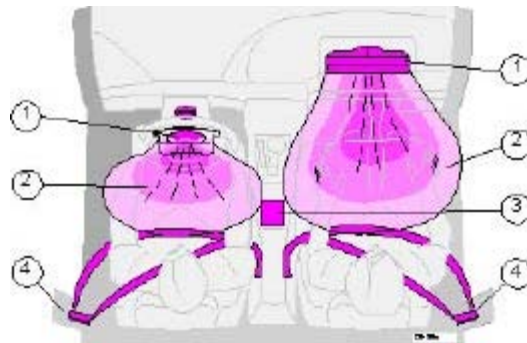

The entire process, including inflation and deflation of the airbags, takes approximately two-tenths of a second.

WARNING!

- As its name implies, SRS is designed to be a SUPPLEMENT to - not a replacement for - the three-point belt system. For maximum protection, wear seat belts at all times. Be aware that no system can prevent all possible injuries that may occur in an accident.
- When installing any optional equipment, make sure that the SRS system is not damaged. Do not attempt to service any component of the SRS yourself. Attempting to do so may result in serious personal injury. If a problem arises, take your car to the nearest authorized Volvo retailer for inspection as soon as possible.

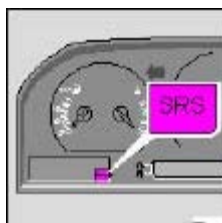

A self-diagnostic system incorporated in the sensor monitors the SRS. This system does not, however, monitor the SIPS airbags. If a fault is detected, the "SRS" warning light will illuminate. The light is included in the warning/indicator light cluster in the instrument panel. Normally, the SRS warning lamp should light up when the ignition is switched on and should go out after 5 seconds or when the engine is started. Check that this light is functioning properly every time the car is started.

The following items are monitored by the self-diagnostic system:

- Sensor unit
- Cable harness
- Gas generator igniters

WARNING!

- Never drive an SRS equipped car with your hands on the steering wheel pad / airbag housing.
- No objects, accessory equipment or stickers may be placed on, attached to or installed near the SRS cover in the center of the steering wheel, the SRS cover above the glove compartment or the area affected by airbag deployment.
- If the SRS warning light stays on after the engine has started or if it comes on while you are driving, drive the car to the nearest authorized Volvo retailer for inspection as soon as possible.

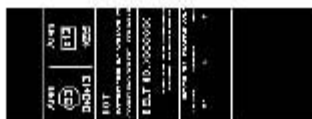

The above is a sample of the label found on all seat belts equipped with tensioners, located on the front seat belts near the lower anchorage point.



The above is a sample of the decal which can be found on the driver's door pillar.

There is no maintenance to perform on the SRS yourself. The only periodic maintenance recommended on the SRS is that the airbag modules and front seat belts (including tensioners) should be replaced every ten years and that the other components in the system (wiring, connectors, etc.) should also be inspected at this time. The SRS decal on your car shows the month and year servicing is due. This service must be performed by an authorized Volvo retailer.

Should you have any questions about the SRS system, please contact

your authorized Volvo retailer or Volvo Customer Support:

In the USA:

Volvo Cars of North America

Customer Relations

P.O. Box 914

Rockleigh, New Jersey 07647-0914 800-663-8255

800-458-1552

In Canada:

Volvo Canada Ltd.

175 Gordon Baker Road

Willowdale, Ontario M2H 2N7



NOTE:

- Deployment of SRS components occurs only one time during an accident. In a collision where deployment occurs, the air bags and seat belt tensioners activate. Some noise occurs and a small amount of powder is released. The release of the powder may appear as smoke-like matter. This is a normal characteristic and does not indicate fire.
- Volvo's dual-threshold air bags use special sensors that are integrated with the front seat buckles. The point at which the air bag deploys is determined by whether or not the seat belt is being used, as well as, the severity of the collision. Collisions can occur where only one of the airbags deploy.

WARNING!

Do not use child safety seats or child booster cushions/backrests in the front passenger's seat. We also recommend that children who have outgrown these devices sit in the rear seat with the seat belt properly fastened.

WARNING!

- Children must never be allowed in the front passenger seat. Volvo recommends that ALL occupants (adults and children) shorter than four feet seven inches (140 cm) be seated in the back seat of any vehicle with a front passenger side airbag. See [page 12](#) for guidelines.
- Occupants in the front passenger's seat must never sit on the edge of the seat, sit leaning toward the instrument panel or otherwise sit out of position. The occupant's back must be as upright as comfort allows and be against the seat back with the seat belt properly fastened.
- Feet must be on the floor, e.g. not on the dash, seat or out of the window.
- No objects or accessory equipment, e.g. dash covers, may be placed on, attached to or installed near the SRS hatch (the area above the glove compartment) or the area affected by airbag deployment (see illustration).
- There should be no loose articles, e.g. coffee cups, on the floor, seat or dash area.
- Never try to open the SRS cover on the steering wheel or the passenger side SRS hatch. This should only be done by an authorized Volvo service technician.
- Failure to follow these instructions can result in injury to the vehicle occupants in an accident.

NOTE: The information on this page does not pertain to the Side Impact Protection System airbags.

When are the airbags deployed?

The SRS system is designed to deploy during certain frontal or frontangular collisions, impacts, or decelerations, depending on the crash severity, angle, speed and object impacted. The SRS sensor is designed to react to both the impact of the collision and the inertial forces generated by it and to determine if the intensity of the collision is sufficient for the airbags to be deployed.

WARNING!

The SRS is designed to help prevent serious injury. Deployment occurs very quickly and with considerable force. During normal deployment and depending on variables such as seating position, one may experience abrasions, bruises, swellings, or other injuries as a result of airbag(s) deployment.

- If the airbags have been deployed, we recommend the following:
- Have the car towed to an authorized Volvo retailer. Never drive with the airbags deployed.
- Have an authorized Volvo retailer replace the SRS system components.
- Use only new, Genuine Volvo Parts when replacing SRS components (airbags, seat belts, tensioners, etc.).

When are the airbags NOT deployed?

Not all frontal collisions activate the SRS system. If the collision involves a nonrigid object (e.g., a snow drift or bush), or a rigid, fixed object at a low speed, the SRS system will not necessarily deploy. Airbags do not normally deploy in a side impact collision, in a collision from the rear or in a rollover situation. The amount of damage to the bodywork does not reliably indicate if the airbags should have deployed or not.

Seat belts the heart of the Volvo safety system

The heart of the Volvo safety system is the **threepoint seat belt** (a Volvo invention)! In order for the SRS system to provide the protection intended, seat belts must be worn at all times by everyone in the car.

The SRS system is a supplement to the seat belts.

WARNING!

If your car has been subjected to flood conditions (e.g. soaked carpeting/standing water on the floor of the vehicle) or if your car has become flooddamaged in any way, do not attempt to start the vehicle or put the key in the ignition before disconnecting the battery (see below). This may cause airbag deployment which could result in personal injury. Have the car towed to an authorized Volvo retailer for repairs.

Automatic transmission only:

Before attempting to tow the car, use the following procedure to override the shiftlock system to move the gear selector to the neutral position.

- Disconnect the battery
- Wait at least one minute
- Insert the key in the ignition and turn it to position 1
- Press firmly on the shiftlock override button (located near the base of the gear selector).
- While holding the override button down, move the gear selector from the park position.

WARNING!

Never drive with the airbags deployed. The fact that they hang out can impair the steering of your car. Other safety systems can also be damaged. The smoke and dust formed when the airbags are deployed can cause skin and eye irritation in the event of prolonged exposure.



[Contents](#) | [Top of Page](#)

2002 VOLVO C70 Coupe & Convertible

Chapter 2 - Instruments, switches and controls

pg. 16 Instruments, switches and controls

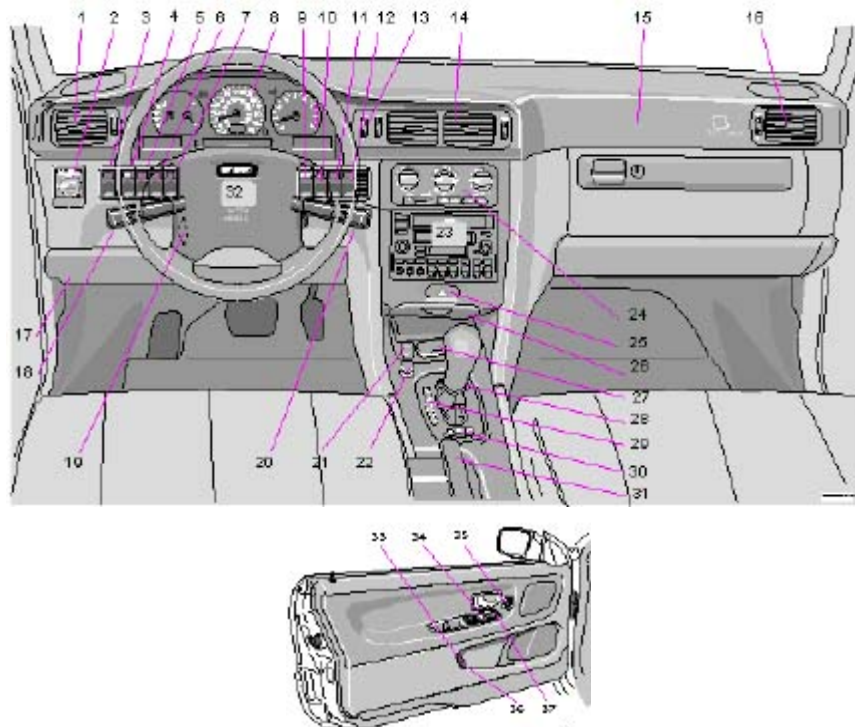

pg. 17 Instruments, switches and controls

The pages in this section provide detailed descriptions of the vehicle's instruments and controls. Note that vehicles may be equipped differently, depending on special legal requirements.

	Page
1 Air vents	35
2 Headlights, parking lights	22
3 Instrument illumination	24
4 Rear fog light	24
5 Front fog lights (optional)	24

6	Space for additional equipment	
7	Space for additional equipment	
8	Instruments	16-17
9	Stability Control System - STC	25
10	Trip computer (optional)	28-30
11	Electrically operated sun roof (C70 Coupe)	44
11	Electrically operated convertible top (C70 Convertible)	44
12	Rear window demister/heated door mirrors	25
13	Air mix	35
14	Air vents	35
15	Passenger side air bag (SRS) hatch	4-6
16	Air vents	35
17	Hood release	58
18	Turn signals, high/low beams, exterior courtesy lights	22
18	Cruise control	31
19	Adjustable steering wheel	34
20	Windshield wiper/washer	23
21	Heated front seats (optional)	32
22	Auxiliary socket	33
23	Audio systems	137
24	Heating and ventilation controls	35-37
25	Hazard warning flashers	25
26	Ashtray	33
27	Coin holder	42
28	Shiftlock release button (automatic transmission only)	105
29	Gear selector shift positions	69-71
30	Winter mode selector	71
31	Parking brake	32
32	Horn/SRS	4-6
33	Trunk open control	59
34	Power window controls	38
35	Power mirror controls	54
36	Fuel tank open control	40
37	Central locking button	38

Some of the items above are available on certain models only.

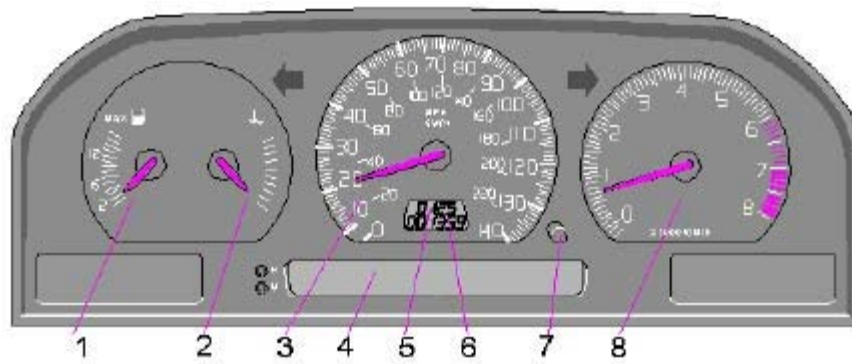

1 Fuel gauge

The fuel tank holds approximately 17.9 US gal. (68 liters). When the warning light comes on there is approximately 1.8 US gal. (8 liters) of fuel remaining. See "Refueling" for further information.

2 Temperature gauge

Do not drive the car with the pointer in the red range. The pointer should be approximately midway on the gauge face when driving. If the pointer approaches the red range repeatedly, check coolant level.

3 Speedometer

4 Clock, ambient temperature sensor, trip computer (certain models)

5 Odometer

6 Trip odometer

NOTE: Digital displays showing Clock, Trip Odometer and Odometer will go off 30 minutes after the ignition has been switched off. To view these displays again, turn the ignition key to position I.

7 Trip odometer reset button

Used for measuring shorter distances. The last digit indicates 1/10 mile/km.

8 Tachometer

Reads thousands of engine rpm. Do not drive for long with the needle in the red section. The engine has an inbuilt function preventing too high a rotation speed. When this function operates, you may discern some pulsation, which in that case is quite normal.

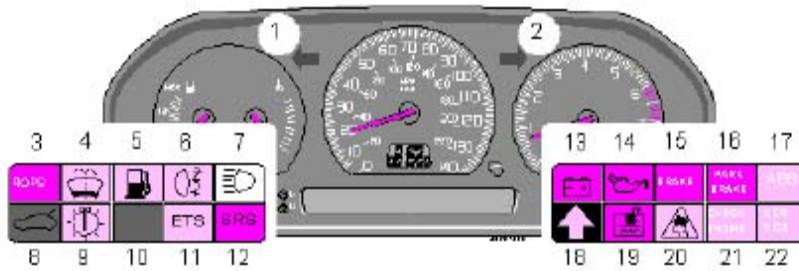

1 Turn signal, left

2 Turn signal, right

3 Cruise control (C70 Coupe) - Roll Over Protection system - ROPS (C70 Convertible)

4 Low washer fluid level

If the lamp glows continuously when the engine is running, there is only about 1/2 - 1 US qt. remaining in the washer fluid reservoir.

5 Low fuel level

When the lamp glows, only about 1.8 US gals. (8 liters) of fuel remain. If the ignition is switched on while refuelling, the gauge may read inaccurately for up to 25 minutes.

6 Rear fog light

7 High beams

8 Trunk open

9 Bulb failure warning sensor

10 (Not in use)

11 Electronic Throttle System (ETS)

12 SRS indicator lamp

13 Generator not charging

14 Low engine oil pressure

15 Brake warning light

16 Parking brake applied

17 ABS-system

18 Transmission mode - Indicates "W", if winter/wet driving mode is active, or indicated currently selected low gear.

19 Low coolant level

20 Stability and Traction Control (STC) System (option)

21 Malfunction indicator lamp

(See [page 20](#) for more information)

22 Service reminder indicator

pg. 20 Warning lights

The warning lights described on [pages 20 and 21](#) should never stay on when driving

When the ignition key is turned on and before the engine starts, all of the warning lights should go on to test the function of the bulbs. Should a light not go off after the engine has started, the system indicated should be inspected. However, the parking brake reminder light will not go off until the parking brake has been fully released.

Malfunction indicator lamp

On-Board Diagnostic II (OBDII): As you drive, a computer called "OBDII" monitors your car's engine, transmission, electrical and emission systems. The CHECK ENGINE light will light up if the computer senses a condition that potentially may need correcting. When this happens, please have your car checked by a Volvo retailer as soon as possible.

A CHECK ENGINE light may have many causes. Sometimes, you may not notice a change in your car's behavior. Even so, an uncorrected condition could hurt fuel economy, emission cleanliness, and driveability. Extended driving without correcting the cause could even damage other components in your car.

Canadian models are equipped with this warning light: 

NOTE: If the fuel filler cap is not closed tightly or if the engine is running when the car is refueled, the Malfunction Indicator Lamp may indicate a fault. However, your vehicle's performance will not be affected. Use only Volvo original or approved fuel filler caps.

Oil pressure warning light

If the light comes on while driving, stop the car and then stop the engine immediately and check the engine oil level. See [page 120](#). If the light stays on after restart, have the car towed to the nearest authorized Volvo retailer. After hard driving, the light may come on occasionally when the engine is idling. This is normal, provided it goes off when the engine speed is increased.

Roll Over Protection System (ROPS)

If the warning lamp remains on after the engine has started or comes on while you are driving, the ROPS self-diagnostic system has detected a fault. The car should be driven to an authorized Volvo retailer as soon as possible for inspection.

Please refer to [page 10](#) for more information on the ROPS system.

Brake failure warning light

If the light comes on while driving or braking, stop immediately, open the hood and check the brake fluid level in the reservoir. See [page 125](#) for reservoir position.

Canadian models are equipped with this warning light: 

WARNING!

If the fluid level is below the MIN mark in either section of the reservoir: **DO NOT DRIVE**. Tow the car to a Volvo retailer and have the brake system checked and any leakage repaired.

Parking brake reminder light

This light will be on when the parking brake (hand brake) is applied. The parking brake lever is situated between the front seats.

Canadian models are equipped with this warning light: 

pg. 21 Warning lights

STC disengaged (option)

The indicator light () in the instrument panel will be ON when you have switched the Stability and Traction Control system (STC) OFF using the button on the dashboard (see [page 25](#)). The light will also come on if there is a fault in the STC system or to indicate that the brakes have overheated. The light will go out when the brake temperature returns to normal. Consult your Volvo retailer.

The symbol will flash when STC is actively regulating power to the drive wheels. Normal power may be reduced at this time. This is normal as power is momentarily reduced to help keep the drive wheels from losing traction and spinning.

Anti-lock Brake system (ABS)

If the warning lamp lights up there is a malfunction of the ABS system (the standard braking system will however function). The vehicle should be driven to a Volvo retailer for inspection.

See [page 78](#) for additional information.

Canadian models are equipped with this warning light: 

Cruise Control - C70 Coupe only

This light will be on when cruise control is engaged. Cruise control will automatically disengage when the ignition is switched off.

Coolant level sensor

If this light comes on while driving, the coolant level is low. The coolant level in the expansion tank should be checked immediately and topped up if necessary. The cooling system should be inspected by an authorized Volvo retailer.

Mode "W" engaged

The lamp will light up when the Winter/Wet starting mode is engaged or if gears "4, 3" or "L" are selected.

If the warning lamp begins to flash, this means that there is a fault in the automatic gearbox. Contact Your Volvo retailer.

SRS Supplemental Restraint System (SRS)

If the light comes on (or stays on after the vehicle has started), the SRS diagnostic system has detected a fault. Drive to an authorized Volvo retailer for an inspection of the system. See the SRS section for more information.

Generator warning light

If the light comes on while the engine is running, have the charging system checked.

SERVICE Service reminder indicator

This light will come on at 7,500 mile (12,000 km) intervals, after 750 hours of driving or after 12 months, whichever occurs first. It is a reminder to the driver that the service interval has been exceeded. The light will stay on for 2 minutes after start until reset by the servicing retailer.

Bulb failure warning light

The light will come on if any of the following bulbs are defective:

- one of the low beam headlights
- one of the tail lights
- one of the brake lights when the brake pedal is depressed.

Check the fuse and bulb. See sections "Replacing bulbs" and "fuses."

Should the warning light come on after a defective outside bulb has been replaced, the corresponding bulb on the other side of the car should also be replaced.

ETS Fault in ETC (Electronic Throttle Control system)

If this lamp comes on, there is a fault in the engine control system and driveability will be affected. Switch the ignition off and then on again. If the light remains on, the system should be inspected by an authorized Volvo retailer.

pg. 22 Headlights, Parking lights, Turn signals

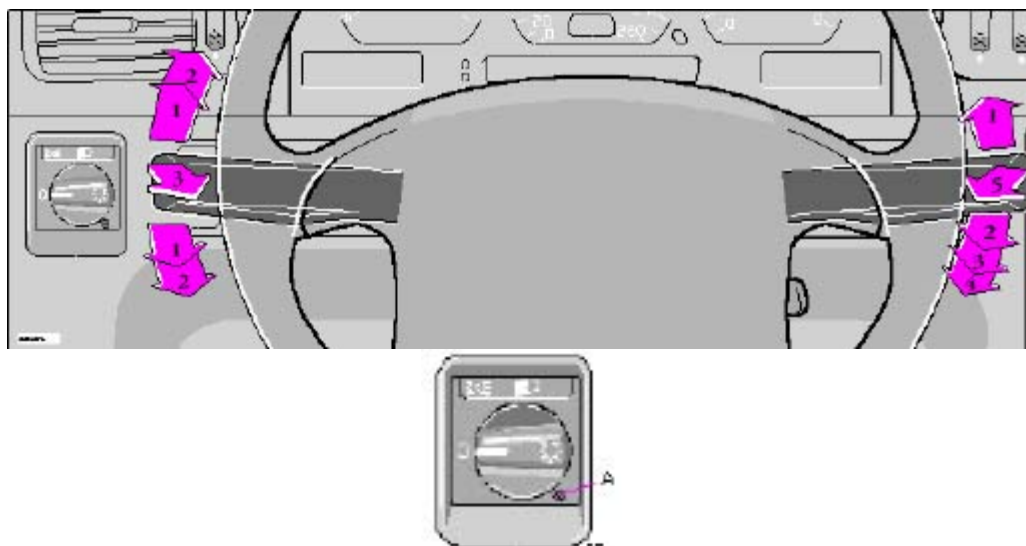



Headlights and parking lights

 All lights off *

 Parking lights on *

 Headlights and parking lights are on if starting (ignition) switch is in positions I or II.

If the headlight switch is in the position  all lights will go out when the starting switch is switched off.

With the headlight switch in position  the parking lights will stay on (headlights off) with the daytime running light screw (A) in position .

The high beams can only be switched on if the headlight switch is in position .

Switch from high to low beams and vice versa by moving the turn signal switch lever on the left side of steering column towards the steering wheel.

* See [page 26](#) for information on Daytime running lights.

Exterior courtesy lights

When you leave your car at night, you can make use of the exterior courtesy lighting function:

- Remove the key from the ignition switch.
- Pull the direction indicator lever towards the steering wheel (as when using the headlight flasher function).

The low beam headlights will now remain on for 30 seconds to light your way.

Turn signals

1 Lane change position. In maneuvers such as lane changing, the driver can flash the turn signals by moving the turn signal lever to the first stop and holding it there. The lever will return to the neutral position when released.

2 Signal lever engaged for normal turns.

3 High beam/low beam switch (headlights on).

Move the lever towards the steering wheel and release it.

Headlight flasher (headlights off).

Move the lever towards the steering wheel. The headlight high beam will be on until the lever is released.

NOTE: A defective turn signal bulb will cause the turn signal indicator and remaining signal lights to flash more rapidly than normal.

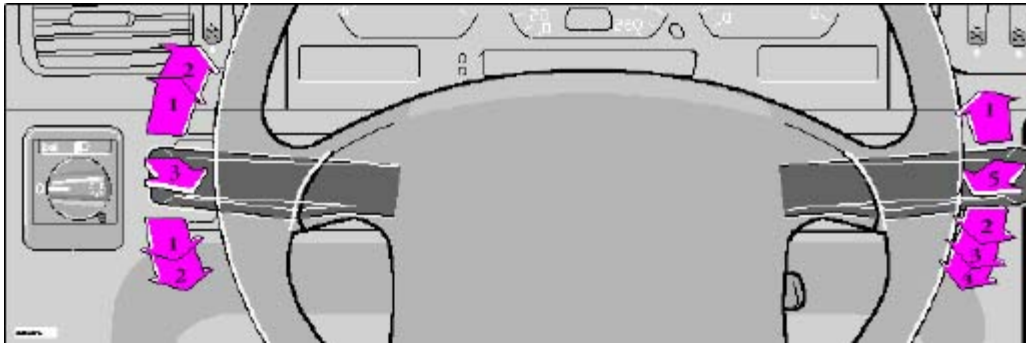

Windshield wipers/washers

1 Intermittent wiper

With the switch in this position, the wipers will sweep approximately every seventh second.

2 "Single sweep" position:





The switch returns automatically when released.

3 Wipers, normal speed

4 Wipers, high speed

5 Windshield wiper/washer, headlight wiper/washer

The wipers will make 23 sweeps across the windshield and headlights (certain models) after the lever is released.

O Locked position: Remove the key to lock the steering wheel*

WARNING!
Never turn the key to position O while driving or when the car is being towed.

I Intermediate position: Certain accessories, radio, etc. on, daytime running lights off.

II Drive position: Key position when engine is running.

III Starting position: Release the key when the engine starts. The key returns automatically to the Drive position.

* On cars equipped with an automatic transmission the gear selector must also be in the (P)ark position.

Starting (ignition) switch/steering wheel lock

If you find it difficult to insert the key in the ignition or to move the steering wheel, the steering wheel lock might be under tension. Turn the wheel back and forth slightly to free the ignition key.

In order to reduce car theft, make sure the steering wheel lock is engaged before leaving the car.

A chime will sound if the starting key is left in the ignition lock and the front door on the driver's side is opened.

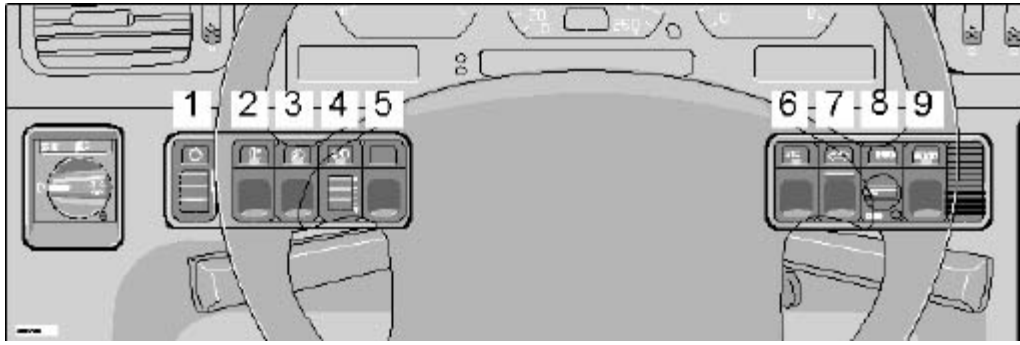

1 - Instrument illumination

To increase the brightness: move the thumbwheel up.

To decrease the brightness: move the thumbwheel down.

2 - Rear fog light *

The rear fog light (located in the driver's side tail light cluster) is considerably brighter than the normal tail lights and should be used only when the atmospheric conditions, such as fog, rain, snow, smoke or dust reduce the daytime or nighttime visibility of other vehicles to less than 500 ft (150 meters).

For the rear fog light to function, the low beam headlights must be switched on.

* By design, there is one rear fog light only, located in the driver's side tail light cluster.

3 - Front fog lights

The front fog lights, located in the front spoiler, will only function in combination with the low beam headlights.

4 - Space for optional equipment

5 - Space for optional equipment



2 0 0 2
VOLVO
C70 Coupe & Convertible

Chapter 3 - Body and interior

pg. 41 Body and interior

	Page
Storage compartments	42
Sun roof	43
Convertible top/wind deflector	44
Keys, doors and locks	46
Remote keyless entry system	47
Alarm	48
Front seats	50
Rear/side view mirrors	53
Interior lights, Vanity mirrors	55
Long load storage	57
Hood	58
Opening the trunk	59
Trunk light, Spare tire, Jack	60
Securing cargo, Avoiding battery drain	61

pg. 42 Storage compartments

WARNING!

Packages on the rear window shelf can obscure vision and may become dangerous projectiles in the event of a sudden stop or an accident.

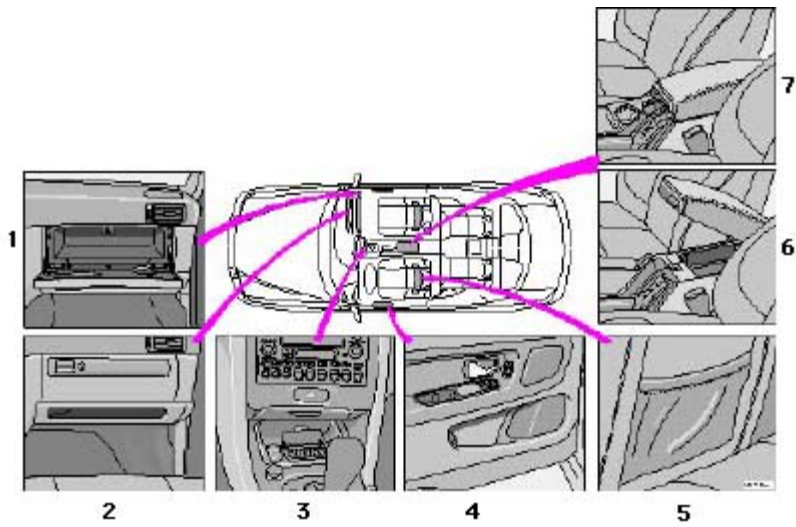

- 1 Glove compartment
- 2 Shelf under glove compartment
- 3 Coin holder
- 4 Compartment in door
- 5 Pocket on rear of front seat
- 6 Compartment between front seats
- 7 Cup holder

pg. 43 Sun roof (option) - C70 Coupe

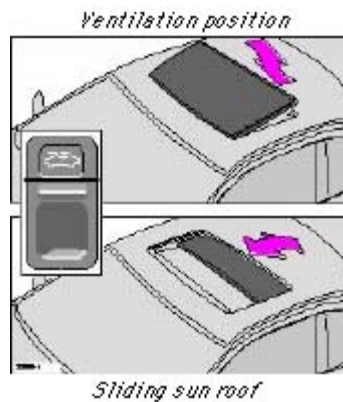

Electrically operated sun roof

The switch for operating the sun roof is located on the instrument panel. The starting

(ignition) key must first be turned to the drive position (position II). The sun roof is also equipped with a one-touch, AUTO-open function.

- **AUTO-open:** Press the lower section of the switch once to automatically open the sun roof.

The AUTO-open function can be stopped at any time by pressing the switch.

- **To close the sun roof:** Depress the upper section of the switch *until the sun roof has closed completely.*

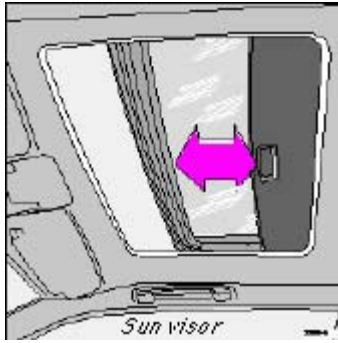

- **To open the rear edge of the sun roof (ventilation position):** With the sun roof closed, depress the upper section of the switch. To close, depress the lower section of the switch until the sun roof has closed completely.
- **To slide open the sun roof :** Depress the lower section of the switch until the sun roof has opened to the position you prefer or until it reaches its final position and stops automatically.

Sun visor: The sun roof also features a sliding sun visor. The visor slides back automatically when the sun roof is opened and also slides back slightly when the sun roof is opened to the ventilation position. The visor must be closed manually.

CAUTION: Do not close the sun visor when the sun roof is in the ventilation position as this could damage the mechanism.

NOTE: The electrically operated sun roof has an overload protecting circuit breaker (fuse no. 37) which is activated when an object blocks the sun roof. Should this occur, remove the object and wait 20 seconds for the circuit breaker to reset. The sun roof should then function normally. Also check fuse no. 35.

WARNING!

The sun roof must never be obstructed in any way when in operation.

pg. 44 Electrically operated convertible top

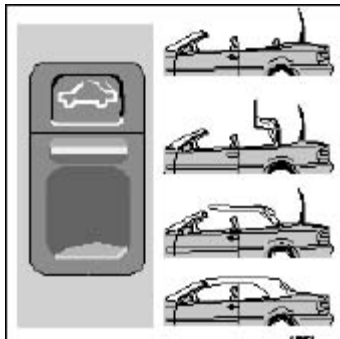

Electrically operated convertible top

Electrically operated convertible top

To lower the convertible top:

- Start the engine. **The car must be at a standstill, the parking brake must be ON and the trunk must be closed when raising/lowering the convertible top.** The gear selector must be in position P (automatic transmission) or in neutral (manual transmission).
- Press and hold down the *lower* section of the control switch (an indicator lamp will light up and all four windows will

automatically be lowered slightly) until the convertible top is completely lowered. A chime will indicate when the top is completely down and properly in place in the storage compartment. The windows can then be raised/lowered with the "All windows" button on the driver's door.

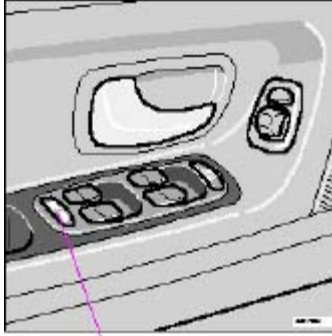

"All windows" control button

To raise the convertible top:

- Press and hold down the *upper* section of the control switch until the convertible top is completely raised. A chime will indicate when the top is properly in position.

Check that the cover over the convertible top storage compartment closes completely.

Movement of the convertible top can be stopped at any time by releasing the control switch.

WARNING!

- The convertible top must not be obstructed in any way when it is being raised or lowered.
- The rear seat should not be occupied while the convertible top is being raised or lowered.
- Anyone near the car should be well clear of the convertible top's moving parts before it is raised or lowered.
- Children should never be allowed to play with the convertible top control switch.

CAUTION: If the cover over the convertible top storage space is not **completely closed**, the trunk lid should NOT be opened to help avoid scratching the paint.

NOTE: · The electrically operated convertible top has an overload protecting circuit breaker that is activated when an object blocks the top when it is in motion. If this occurs, remove the object and wait 20 seconds for the circuit breaker to reset before trying to raise/lower the top again.

See [page 106](#) for fault tracing information and instructions on manually raising the convertible top.

- The trunk cannot be opened and the power windows/power antenna cannot be operated while the convertible top is being raised/lowered.

pg. 45 Electrically operated convertible top, Wind deflector

CAUTION:

- Be sure there is sufficient clearance above the car before raising/lowering the convertible top.
- Volvo recommends that you raise the convertible top and close the windows when you leave the car to help deter thefts and to protect the interior from rain, windblown dust, etc.
- No objects should be placed in the convertible top storage compartment. This could damage the convertible top mechanism.
- Roof racks may not be attached to or placed on the convertible top. See [page 74](#) for information on trunk-mounted luggage racks.
- Ice scrapers should not be used to remove snow from the convertible top.
- Do not lower the convertible top if it is frozen. The top should not be raised/lowered if the temperature is below 32° F (0° C).
- The top should be completely dry before it is lowered and stored in the storage compartment to help prevent damage

from mildew.

See [page 111](#) for information on cleaning the convertible top.

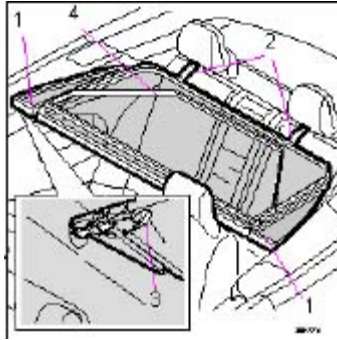

Wind deflector (option/accessory)

Installing the wind deflector:

- Fold out the panels on the sides of the wind deflector (1).
- Slide the two metal slats on the wind deflector under the rear seat head restraints (2). Slide them carefully to avoid damaging the upholstery.
- Press the catches (3) into the holes provided in the side panel until they click into place.
- Raise the wind deflector (4) 90°.

NOTE: The panels on the sides of the wind deflector can be folded under so that the deflector can be stored in the trunk. The catches (3) must be pushed in (toward the center of the car) before the panels can be folded.

WARNING!

The wind deflector must be securely attached to help avoid injury to the occupants of the car or to other motorists.

pg. 46 Keys, doors and locks



Doors and locks

Your car is equipped with a central locking system. The key, used on the driver's door, the remote control or central locking button, will lock/unlock both doors and the trunk.

- **Turn the key once** to unlock the driver's door only.
 - **Turn the key again (within 10 seconds)** to unlock both doors and the trunk.
- One turn with the key towards lock in the drivers door locks both doors and the trunk.
- Use the switch on the front door armrests to lock/unlock the car from the inside.
- Check the action of the button on the other door to verify its function (lock/ unlock).

WARNING!

If the doors are locked while driving, this may hinder rapid access to the occupants of the car in the event of an accident. (Also see information on "Child safety locks").

NOTE:

- If a door is not closed completely, the courtesy lights will stay on and a chime will sound until the door is closed.
- As an added anti-theft measure, new keys have been developed which may take slightly longer to copy or replace if the original keys are misplaced. Duplicate keys may be ordered from your Volvo retailer.

Immobilizer (start inhibitor)

Each of the keys supplied with your car contains a coded transmitter and receiver (transponder). The code in the key is transmitted to an antenna in the ignition switch where it is compared to the code stored in the start inhibitor module. The car can only be started if a properly coded key is used.

If you misplace a key, take the other keys to an authorized Volvo retailer. The existing code in the start inhibitor module and all the keys will be erased as an antitheft measure and a new code will be programmed in.

NOTE:

Not more than one of the keys for your car should be kept on the same key ring. This could cause conflicting signals to be transmitted to the ignition switch, making it impossible to start the car.

This device complies with part 15 of the FCC rules. Operation is subject to the following condition: (1) This device may not cause harmful interference, and (2) this device must accept any interference received, including interference that may cause undesired operation.

The key number codes are stamped on a separate tag supplied with the keys. This tag should be separated from the key ring and kept in a safe place.

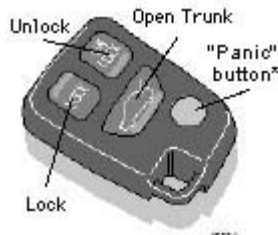

Remote keyless entry system

Your car is equipped with a remote control transmitter. This transmitter uses a radio frequency which will allow "keyless" entry into the passenger compartment or the trunk. You will be supplied with two coded key ring transmitters, which will enable you to lock/unlock both doors and the trunk from a distance of 10-15 feet (3-5 meters).

On vehicles equipped with an alarm, the alarm will also be activated/deactivated by this system.

The car can also be locked/unlocked with the key.

As an extra security precaution in certain situations (valet parking, etc.), Volvo recommends that the transmitter not be included when the keys are given to anyone. The service key can be used instead. If one of the transmitters is misplaced, contact the nearest authorized Volvo retailer for assistance.

Using the remote control

- Press the **LOCK** button once to lock both doors and the trunk.
- Press the **UNLOCK** button **once** to unlock the driver's door only. Press this button again (within 10 seconds) to unlock both doors and the trunk.
- Press the **OPEN trunk** button twice within 3 seconds to pop open the trunk.

NOTE:

- If only the driver's door is unlocked, the lock will automatically reengage (re-lock) and the alarm will reset after 2 minutes unless the door has been opened.
- The lock/unlock and alarm features can also be utilized by using the keys. See section: Doors and Locks on [page 42](#).
- If the alarm LED glows continuously for 5 seconds, this indicates a fault in the system or that a door is not properly closed.
- : To avoid leaving your keys in the car, make a habit of always locking the car with the remote control.

WARNING!

Volvo does not recommend using the transmitter to lock the doors from inside the car. On cars equipped with an alarm, the alarm would be activated and would sound when one of the doors is opened. The doors must not be locked using the remote transmitter while the vehicle is occupied. In case of an accident, this may hinder rapid access to the occupants of the vehicle. The alarm will also sound on models equipped with this feature.

FCC ID:LQNP2T-APU

This device complies with part 15 of the FCC rules. Operation is subject to the following conditions: (1) This device may not cause harmful interference, and (2) this device must accept any interference received, including interference that may cause undesired operation.

Canadian 2306104388

Model 504 2927 by Donnelly Operation is subject to the following conditions: (1) this device may not cause interference, and (2) this device must accept any interference, including interference that may cause undesired operation of the device

Canadian 2306104388A

Model 509 977 by Connaught Electronics Operation is subject to the following conditions: (1) this device may not cause interference, and (2) this device must accept any interference, including interference that may cause undesired operation of the device

* See also on [page 48](#).

pg. 48 Alarm (certain models)

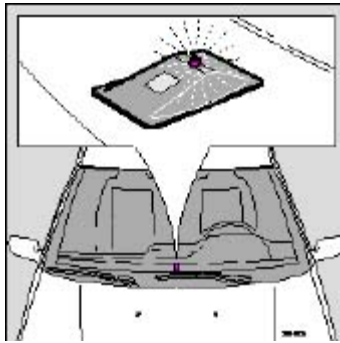

LED alarm status indicator

Alarm

The radio signal emitted from the transmitter, which is used to set/unset the alarm, is a "rolling code" signal. This means that the signal is changed randomly for each transmission and is intended to help prevent unauthorized recording of the code.

When armed (set), the alarm continuously monitors a number of points on the car. The following conditions will set off the alarm:

- The hood is opened
- The trunk is opened
- A door is opened
- The ignition switch is tampered with
- The car is lifted or towed (if the car is equipped with the optional inclination sensor)
- The battery is disconnected (if the car is equipped with the optional backup battery siren). The alarm will sound for ten 30 second intervals, with a 5 second pause between intervals. This function cannot be interrupted



Arming (setting) the alarm

Press the LOCK button on the remote control, lock the car using the key in the driver's door or press the central lock button on one of the doors with the door open. One long flash of the turn signals will confirm that the alarm is set.

Disarming the alarm

Press the UNLOCK button on the remote control or unlock the doors with the key.

Turning off (stopping) the alarm

If the alarm is sounding, it can be stopped by pressing the UNLOCK button on the remote control or by unlocking the driver's door with the key.

If the alarm is stopped with the remote control, this will be confirmed by two short flashes from the turn signals.

"Panic" function

In an emergency situation, this feature can be used to attract attention.

Activate the "panic" function by pressing the red panic button on the remote control for at least 3 seconds or by pressing this button twice within 3 seconds. The turn signals will flash, the interior lights will go on and the alarm will sound.

The function can be turned off by pressing any of the buttons on the remote control or will stop automatically after 25 seconds.

NOTE: This button will **NOT** unlock the car.

Audible alarm signal

An audible alarm signal is given either by a separate alarm horn or by the optional backup siren. One alarm cycle lasts for 30 seconds.

Visual alarm signal

The visual alarm signal is given by flashing all turn signals and turning on the interior lighting for approximately 5 minutes.

Automatic reset function

If only the driver's door is unlocked with the remote control, the lock will automatically reengage (re-lock) and the alarm will reset after 2 minutes unless the door has been opened.

Temporarily disconnecting the alarm sensor(s)

In certain situations it may be desirable to disconnect the **optional** alarm sensors, particularly the inclination sensor, if, for example, you drive your car onto a ferry where the rocking of the boat could trigger the alarm.

To temporarily disconnect the sensor(s) from the alarm system:

- With both doors closed, switch off the ignition and remove the key from the ignition switch
- Press the locking (left) side of the central locking button on the driver's door for at least 3 seconds
- The doors will first lock and then unlock after 3 seconds to confirm that the sensors have been disconnected

The car can then be locked in the usual way to set the alarm.

NOTE: The sensors will automatically be reconnected to the alarm system the next time the ignition is switched on.

LED alarm status signals

The status of the alarm system is indicated by the red LED at the top center of the dash:

- LED off - the alarm is not armed (set)
- LED flashes once per second - the alarm is armed (set)
- LED flashes rapidly before the ignition is switched on - the alarm has been triggered
- LED flashes rapidly for 15 seconds after the ignition has been switched on - a fault has been detected in the alarm system. Contact a Volvo retailer.

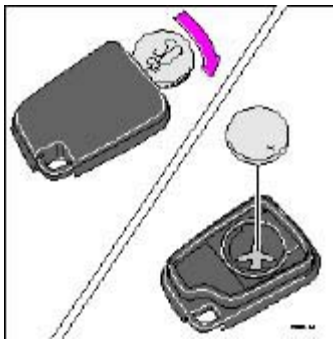

Batteries

Each remote transmitter is powered by a three-volt battery, type CR 2016. If the range of the transmitter is noticeably reduced, this indicates that the battery is weak and should be replaced.

Replacement: Remove the battery cover on the back of the transmitter with a coin. Replace the battery. Reinstall the cover, making sure it is secured tightly to help protect the transmitter.

CAUTION: Do not attempt to service or repair any components of the alarm system yourself. This should only be done by an authorized Volvo retailer.

Electrically operated seats with memory function



- 1 Lumbar support
- 2 Strap for controlling front seat for rear seat passengers
- 3 Backrest release control lever
- 4 Power seat control panel

Power seat control panel

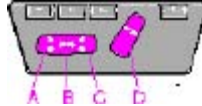

A-seat front (raise/lower), B-forward/rearward, C-seat rear (raise/lower), D-backrest tilt

WARNING!

- The power seats are operable with the ignition OFF. Therefore, children should never be left unattended in the car.
- Do not adjust the seat while driving. The seat should be adjusted so that the brake pedal can be depressed fully. In addition, position the seat as far rearward as comfort and control allow. The seat rails on the floor must not be obstructed in any way when the seat is moved.
- Make sure the seats are securely locked in position after they have been adjusted.



Programming the memory

Three seat positions can be programmed. To program a seat position:

- 1 Adjust the seat to the desired position.
- 2 Depress the MEM button.
- 3 Press button 1 to program the current position of the seat.

- Buttons 2 and 3 can be programmed in the same way. To move the seat to a programmed position, depress button 1, 2 or 3 until the seat stops.
- If the button is released before the seat has reached the programmed position, the seat will stop as a safety precaution.

NOTE: The seat has an overload protector which engages if an object blocks the movement of the seat. If this happens, remove the object and wait 20 seconds before operating the seat again.

WARNING!

Do not adjust the seat while driving. The seat should be adjusted so that the brake pedal can be depressed fully. In addition, position the seat as far rearward as comfort and control allow. The seat rails on the floor must not be obstructed in any way when the seat is moved.

Movement of the seat can be STOPPED at any time by pressing any button on the power seat control panel.

pg. 51 Front seats

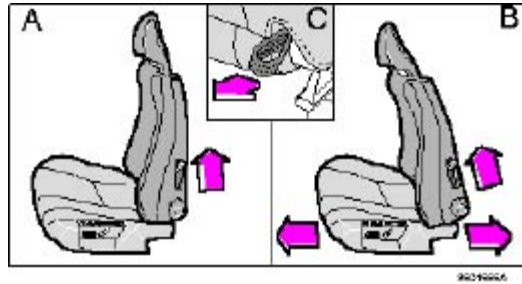

Tilting the backrests - moving the seats

Tilting the backrest

The backrests are locked in the upright position and can be tilted forward to allow access to the rear seat.

1. Lift the control lever on the side of the front seat (A)
2. Tilt the backrest forward until it locks into place to reach objects in the rear seat.

Moving the seat forward

1. Lift and hold up the control lever on the side of the front seat (A).
2. Tilt the backrest forward (B).

Electrically operated seats: The seat will slide forward until the control lever is released or until it reaches the forward-most position.

Manually operated passenger's seat:** When the backrest has been tilted forward, the seat can be moved forward/rearward *without holding the control on the side of the seat*.

To tilt up the backrest to its normal position:

1. Press the backrest slightly forward and pull the control lever up to release the backrest locking mechanism (electrically operated seats only).
2. Tilt the backrest toward the rear of the car.
3. **Electrically operated seats:** Hold the control lever up to allow the seat to slide back to its original position

Manually operated passenger's seat:** move the seat to the desired position.

To exit the rear seat:

- Pull the strap on the lower inside corner of the seat (C).
- Push the backrest forward.
- The seat will slide forward until the strap is released (electrically operated seats)*. If the car is equipped with a manually operated passenger's seat, push the seat forward.

* If the backrest is in the upright position, the seat will slide rearward until the strap is released.

**Please see the following page for information on adjusting the manually operated passenger's seat.

pg. 52 Front seats

Manually operated passenger's seat (certain models)

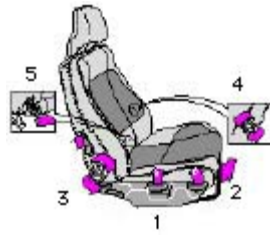

1 Height adjustment

The front section of the seat can be adjusted to 7 different height settings (lever A) and the rear section can be adjusted to 9 different height settings (lever B).

2 Forward-rearward seat adjustment

Pull the bar upward, then slide the seat forward or rearward to the desired position. Make sure that the seat is properly secured when you release the bar.

3 Backrest tilt

Rotate the control counterclockwise to tilt the backrest rearward and clockwise to tilt the backrest forward.

4 Lumbar support

5 Strap for controlling front seat for rear seat passengers (see following page)



[Contents](#) | [Top of Page](#)

**2002
VOLVO
C70 Coupe & Convertible**

Chapter 4 - Starting and driving

pg. 63 Starting and driving

	Page
Fuel requirements, Refueling	64
Driving economy	67
Starting the engine	68
Manual transmission	69
Automatic transmission	70
Points to remember	72
Roof/trunk-mounted luggage racks	74
Emergency towing	75
Vehicle towing information	76
Jump starting	77
Brake/Stability systems	78-79
Trailer towing	80
Winter driving	81

pg. 64 Fuel requirements

NOTE ENGINE OIL:

Although some oil consumption occurs during normal engine operation, more oil is consumed when the engine is new as the internal parts generate higher friction while wearing in to each other. **From the time the engine is new until the first service is performed, the oil consumption could be higher than normal. For this reason, it is especially important to check the oil every time you refuel your car during this period. See [page 120](#).**

In general, the rate of oil consumption depends on such factors as: engine temperature, length of trip, driving conditions, oil viscosity and quality, engine speed and acceleration/deceleration.

Checking your engine oil level each time the car is refueled is one of the most important items you can perform to help keep your car in good running order.

Manual transmission

The following speeds should not be exceeded during the breakin period:

	Up to 600 miles (1000 km)	600 1,200 miles (1000 2000 km)
1st gear	20 mph (30 km/h)	25 mph (40 km/h)
2nd gear	30 mph (50 km/h)	40 mph (70 km/h)
3rd gear	45 mph (80 km/h)	65 mph (100 km/h)
4th gear	70 mph (110 km/h)	80 mph (130 km/h)
5th gear	80 mph (130 km/h)	95 mph (150 km/h)

Posted speed limits should not be exceeded.

Deposit control gasoline (detergent additives)

Volvo recommends the use of gasoline containing deposit control additives. These additives have shown to be effective in keeping injectors and intake valves clean. Consistent use of deposit control gasolines will help ensure good driveability and fuel economy. If you are not sure whether the gasoline contains deposit control additives, check with the service station operator.

Unleaded fuel

Each Volvo has a three-way catalytic converter and must use only unleaded gasoline. U.S. and Canadian regulations require that pumps delivering unleaded gasoline be labelled "UNLEADED". Only these pumps have nozzles which fit your car's filler inlet. It is unlawful to dispense leaded fuel into a vehicle labelled "unleaded gasoline only". Leaded gasoline damages the three-way catalytic converter and the heated oxygen sensor system. Repeated use of leaded gasoline will lessen the effectiveness of the emission control system and could result in loss of emission warranty coverage. State and local vehicle inspection programs will make detection of misfueling easier, possibly resulting in emission test failure for misfueled vehicles.

NOTE: Some U.S. and Canadian gasolines contain an octane enhancing additive called methly-cyclopentadienyl manganese tricarbonyl (MMT). If such fuels are used, your Emission Control System performance may be affected, and the Malfunction Indicator Lamp located on your instrument panel may light. If this occurs, please return your vehicle to an authorized Volvo retailer for service.

Octane rating

Volvo engines are designed for optimum performance on unleaded premium gasoline with an octane rating. AKI of 91, or above. AKI (ANTI KNOCK INDEX) is an average of the Research Octane Number, RON, and the Motor Octane Number, MON. $(RON + MON/2)$.

The minimum octane requirement is AKI 87 (RON 91).

pg. 65 Fuel requirements

Fuel Formulations

Do not use gasoline that contains lead as a knock inhibitor, and do not use lead additives. Besides damaging the exhaust emission control systems on your car, lead has been strongly linked to certain forms of cancer. Many fuels contain benzene as a solvent. Unburned benzene has been strongly linked to certain forms of cancer. If you live in an area where you must fill your own gas tank, take precautions. These may include:

- standing upwind away from the filler nozzle while refueling
- refueling only at gas stations with vapor recovery systems that fully seal the mouth of the filler neck during refueling
- wear neoprene gloves while handling a fuel filler nozzle.

Use of Additives

With the exception of gas line antifreeze during winter months, do not add solvents, thickeners, or other store-bought additives to your car's fuel, cooling, or lubricating systems. Overuse may damage your engine, and some of these additives contain organically volatile chemicals. Do not needlessly expose yourself to these chemicals.

Carbon Monoxide - Important Warning

Carbon monoxide is a poisonous, colorless, and odorless gas. It is present in all exhaust gases. If you ever smell exhaust fumes inside the vehicle, make sure the passenger compartment is ventilated, and immediately return the vehicle to your retailer for correction.

Gasoline containing alcohol and ethers

"Oxygenated fuels"

Some fuel suppliers sell gasoline containing "oxygenates" which are usually alcohols or ethers. In some areas, state or local laws require that the service pump be marked indicating use of alcohols or ethers. However, there are areas in which the pumps are unmarked. If you are not sure whether there is alcohol or ethers in the gasoline you buy, check with the service station operator.

To meet seasonal air quality standards, some areas require the use of "oxygenated" fuel.

Volvo allows the use of the following "oxygenated fuels; however, the octane ratings listed on this page must still be met.

Alcohol — Ethanol

Fuels containing up to 10% ethanol by volume may be used.

Ethanol may also be referred to as Ethyl alcohol, or "Gasohol".

Ethers — MTBE

Fuels containing up to 15% MTBE may be used.

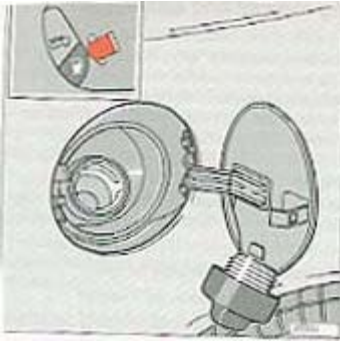

Fuel filler door control on driver's door

Refueling

The fuel tank holds approximately 17.9 US gal. (68 liters) with sufficient volume left over to accommodate possible expansion of the fuel in hot weather. Be aware that the "usable" tank capacity will be somewhat less than the specified maximum. When the fuel level is low, such factors as ambient temperature, the fuel's "Reid vapor pressure" characteristics, and terrain can affect the fuel pumps' ability to supply the engine with an adequate supply of fuel. Therefore, it is advisable to refuel as soon as possible when the needle nears the red zone, or when the fuel warning light comes on.

Fuel filler door

The fuel filler door (on the right rear fender) is locked and must be popped open using the control on the driver's door. **Open fuel filler cap slowly during hot weather conditions**

CAUTION:

- Do not refuel with the engine running. Turn the ignition off or to position I. If the ignition is on, an incorrect reading could occur in the fuel gauge.
- After refueling, close the fuel filler cap by turning it clockwise until it *clicks* into place *.
- Allow for fuel expansion by not overfilling the tank. Overfilling could also cause damage to the emission control systems.
- Avoid spilling gasoline during refueling. Gasolines containing alcohol can cause damage to painted surfaces, which may not be covered under the New Vehicle Limited Warranty.
- Do not use gasolines containing methanol (methyl alcohol, wood alcohol). This practice can result in vehicle performance deterioration and can damage critical parts in the fuel system. Such damage may not be covered under the New Vehicle Limited Warranty.

* If the fuel filler cap is not closed tightly or if the engine is running when the car is refueled, the Malfunction Indicator Lamp may indicate a fault. However, your vehicle's performance will not be affected. Use only Volvo original or approved fuel filler caps.

Economical driving conserves natural resources

Better driving economy may be obtained by thinking ahead, avoiding rapid starts and stops and adjusting the speed of your vehicle to immediate traffic conditions. Observe the following rules:

- Bring the engine to normal operating temperature as soon as possible by driving with a light foot on the accelerator pedal for the first few minutes of operation. A cold engine uses more fuel and is subject to increased wear.

- Whenever possible, avoid using the car for driving short distances. This does not allow the engine to reach normal operating temperature.
- Drive carefully and avoid rapid acceleration and hard braking.
- Do not exceed speed limit.
- Avoid carrying unnecessary items (extra load) in the car.
- Maintain correct tire pressure. Check tire pressure regularly (check when tires are cold).
- Remove snow tires when threat of snow or ice has ended.
- Note that trunk-mounted luggage racks increase air resistance and thereby fuel consumption.
- Avoid using automatic transmission kickdown feature unless necessary.
- Avoid using the air conditioning when it is not required. When engaged, the air conditioner's compressor places an additional load on the engine. However, please note that fuel consumption is lower with the air conditioning on than it is when driving with the air conditioning switched off and the windows down.
- If your car is equipped with the optional Trip Computer, utilizing the fuel consumption modes can help you "learn" how to drive more economically.

Other factors which decrease gas mileage are:

- Dirty air cleaner
- Dirty engine oil and clogged oil filter
- Dragging brakes
- Incorrect front end alignment

Some of the above mentioned items and others are checked at the standard Maintenance Service intervals.

NOTE: (D)rive or 5th gear (manual transmissions) should be used as often as possible to help improve fuel economy.

pg. 68 Starting the Engine

Starting and stopping

1. Fasten the seat belt.

WARNING!

Before starting, check that the seat, steering wheel and mirrors are adjusted properly. Make sure the brake pedal can be depressed completely. Move the seat closer if necessary. Refer to section "front seats".

2. Apply the parking brake, if not already set. The gear selector (**automatic transmission**) is locked in the (P)ark position (**SHIFT LOCK**).

Manual transmission: the clutch must be fully depressed.

3. **Without touching the accelerator pedal**, turn the ignition key to the starting position*. Allow the starter to operate for up to 10 seconds. Release the key as soon as the engine starts. If the engine fails to start, repeat step 3.

For cold starts at altitudes above 6000 ft (1800 meters), depress the accelerator pedal halfway and turn the key to the starting position. Release the pedal slowly when the engine starts.

4. To release the gear selector from the (P)ark position (automatic transmission), the ignition key must be in position II and the brake pedal must be depressed. See [page 105](#) for instructions on manually releasing the **SHIFTLOCK**

system.

Do not race a cold engine immediately after starting. Oil flow may not reach some lubrication points fast enough to prevent engine damage.

NOTE: (Automatic transmission only)

Your car is equipped with a **KEYLOCK** system. When the engine is switched off, the gear selector must be in the **(P)**ark position before the starting key can be removed from the ignition switch.

5. Select the desired gear. The gear engages after a slight delay (automatic transmission) which is especially noticeable when selecting R.

CAUTION: (Automatic transmission only)

The engine should be idling; never accelerate until after you feel the gear engage! Too rapid acceleration immediately after selecting a gear will cause harsh engagement and premature transmission wear.

NOTE: Selecting P or N (automatic transmission) when idling at a standstill for prolonged periods of time will help prevent overheating of transmission oil.

WARNING!

Always place the gear selector (automatic transmission) in Park and apply the parking brake before leaving the vehicle. Never leave the car unattended with the engine running.

Always open the garage doors fully before starting the engine inside a garage to ensure adequate ventilation. The exhaust gases contain carbon monoxide, which is invisible and odorless but very poisonous.

CAUTION:

Never race the engine **immediately after starting**. Oil flow may not reach some lubricating points fast enough to prevent engine damage.

Do not race the engine just prior to switching off!

* If the key is left in the Drive position (position II) for more than 30 seconds, it must be turned to position 0 and then turned to the Start position (position III) again in order to start the car. See [page 23](#) for ignition key positions.

pg. 69 Manual transmission

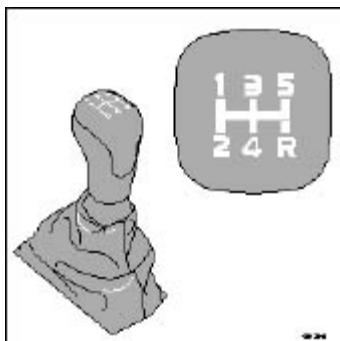

Shift positions

Depress the clutch pedal completely when changing gears*.

Remove your foot from the clutch pedal while driving.

Overdrive (5th gear) should be used as often as possible to help improve fuel economy. This gear can be engaged at speeds above approx. 50 mph (80 km/h).

CAUTION: Follow the shift pattern indicated on the gear shift knob when shifting up (e.g., do not shift directly from 2nd to 5th gear) to help avoid excessive wear on the transmission.

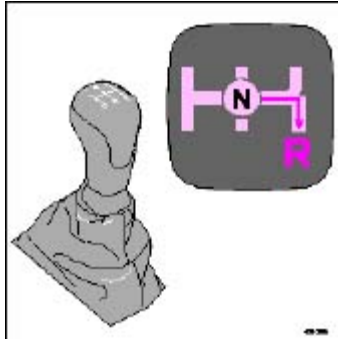

Engaging reverse gear

The gear lever must first be moved to neutral in order to engage reverse gear.

CAUTION: Be careful that you do not inadvertently engage reverse while moving forward.

* Clutch interlock (manual transmission only)

The clutch must be fully depressed before you can start your car. If the clutch is not depressed, it will not be possible to start the engine.

pg. 70 Automatic transmission

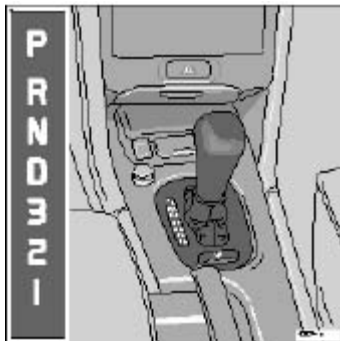

P (Park)

Use this position when starting the engine or parking the car.

Never use P while the car is in motion.

The parking brake should be set whenever the car is parked.

The gear selector is mechanically locked in the P position (SHIFTLOCK). To release the gear selector from this position, the engine must be running (or the ignition key must be in position II) and the brake pedal must be depressed.

WARNING! Never leave the car unattended when the engine is running. If, by mistake, the gear selector is moved from P, the car may start moving.

R (Reverse)

Never engage R while the car is moving forward.

N (Neutral)

Neutral - no gear engaged. Use the parking brake.

D (Drive)

D is the normal driving position and should be used as often as possible to help improve fuel economy. The car should not be moving when shifting from R to the D position.

4 (Intermediate gear)

The transmission will shift automatically between gears 4, 3, 2 or 1 from this position. **The transmission cannot shift up to (D) from fourth gear.**

3 (Intermediate gear)

The transmission will shift automatically between gears 3, 2 and 1 from this position. **The transmission cannot shift up to fourth gear of (D)rive from third gear.**

L (Low gear)

The transmission is locked in gears 1 and 2 when the selector is in this position.

NOTE:

- Gears 4, 3, or 1 can be used if you are driving in a mountainous area, towing a trailer or to increase engine braking effect.
- The transmission has a built-in limiter designed to help prevent excessive engine speeds (high rpm) when gears 4, 3 or L are selected.

Automatic transmission - adaptive control system

The automatic transmission is controlled by an adaptive guidance system that constantly monitors the way in which the transmission functions. It senses and adapts each gear shift for optimal performance. The system also monitors your

particular driving style and adapts gear shifting accordingly.



[Contents](#) | [Top of Page](#)

**2002
VOLVO
C70 Coupe & Convertible**

Chapter 5 - Wheels and tires

pg. 83 Wheels and tires

	Page
General information, Wear indicator, Tire economy, Flat spots	84
Snow chains, Snow tires	85
Inflation pressure	86
Uniform tire quality grading	87

pg. 84 Wheels and tires

General information

Your vehicle is equipped with tires according to the tire information label located on the rear facing side of the right front door.

The following is an **example** of a tire designation code 225/50R16:

225 = tire width in mm.

50 = tire profile. This is the relationship (in percent) between the section height and width of the tire.

R = radial tires.

16 = diameter in inches.

The tires have good road holding characteristics and offer good handling on dry and wet surfaces. It should be noted however that the tires have been developed to give these features on snow/icefree surfaces. **Certain models are equipped with "all-season" tires, which provide a somewhat higher degree of road holding on slippery surfaces than tires without the "all-season" rating.** However, for optimum road holding on icy or snow covered roads **we recommend suitable winter tires on all four wheels.** When replacing tires, be sure that the new tires are the same size designation, type (radial) and preferably from the same manufacturer, on all four wheels. Otherwise there is a risk of altering the car's roadholding and handling characteristics.

NOTE: When storing wheel/tire assemblies (e.g. winter tires and wheels), either stand the assemblies upright, or suspend them off the ground. Laying wheel/tire assemblies on their sides for prolonged periods can cause wheel and/or

tire damage.

Wear indicator

The tires have a so-called "wear indicator" in the form of a number of narrow strips running across or parallel to the tread. When approx. 1/16" (1.6 mm) is left on the tread, these strips become visible and indicate that the tire should be replaced.

Tires with less than 1/16" (1.6 mm) tread have a very poor grip in rain or snow.

When replacing worn tires, it is recommended that the tire be identical in type (radial) and size as the one being replaced. Using a tire of the same make (manufacturer) will prevent alteration of the driving characteristics of the vehicle.

To improve tire economy:

- Maintain correct tire pressure.
- Drive smoothly: avoid fast starts, hard braking and tire screeching.
- Tire wear increases with speed.
- Correct front wheel alignment is very important.
- Unbalanced wheels impair tire economy and driving comfort.
- If the wheels are rotated, they should be kept on the same side of the car so that they revolve in the same direction as prior to rotation.
- Hitting curbs or potholes can damage the tires and/or wheels permanently.

Flat spots

All tires become warm during use. After cooling, when the vehicle is parked, the tires have a tendency to distort slightly, forming flat spots. These flat spots can cause vibrations similar to the vibrations caused by unbalanced wheels. They do, however, disappear when the tire warms up. The degree to which flat spots form depends on the type of cord used in the tire. Remember that, in cold weather, it takes longer for the tire to warm up and consequently longer for the flat spot to disappear.

pg. 85 Wheels and tires

Snow chains

Snow chains can be used on your Volvo with the following restrictions:

- Snow chains should be installed on front wheels only. Use only Volvo approved snow chains.
- Snow chains may be mounted on tire dimension 195/65R15. Tire dimension 205/55R16 requires a special type of snow chain. Consult your Volvo retailer.

If accessory, aftermarket or "custom" tires and wheels are installed and are of a size different than the original tires and wheels, chains in some cases CANNOT be used. Snow chains cannot be used on those models fitted with all-season tires 225/50 R16 or 225/45 R17 or 225/40R18. Sufficient clearances between chains and brakes, suspension and body components must be maintained.

- Some strapon type chains will interfere with brake components and therefore CANNOT be used.

Consult your Volvo retailer for additional snow chain information.

CAUTION:

- Check local regulations regarding the use of snow chains before installing.
 - Always follow the chain manufacturer's installation instructions carefully. Install chains as tightly as possible and retighten periodically.
 - Never exceed the chain manufacturer's specified maximum speed limit. (Under no circumstances should that limit be higher than 30 mph (45 km/h).
 - Avoid bumps, holes or sharp turns when driving with snow chains.
 - The handling of the vehicle can be adversely affected when driving with chains. Avoid fast or sharp turns as well as locked wheel braking.
-

Snow tires, studded tires *

Tires for winter use:

Owners who live in or regularly commute through areas with sustained periods of snow or icy driving conditions are strongly advised to fit suitable winter tires to help retain the highest degree of traction.

It is important to install winter tires **on all four wheels** to help retain traction during cornering, braking, and accelerating. Failure to do so could reduce traction to an unsafe level or adversely affect handling. Do not mix tires of different design as this could also negatively affect overall tire road grip. **Volvo recommends 195/65 R15 winter tires on 15" steel wheels on all C 70 models including those equipped with 16", 17" or 18" wheels.**

Winter tires wear more quickly on dry roads in warm weather. They should be removed when the winter driving season has ended.

Studded tires should be run in 300-600 miles (500-1000 km) during which the car should be driven as smoothly as possible to give the studs the opportunity to seat properly in the tires. The car tires should have the same rotational direction throughout their entire lifetime. In other words, if you wish to rotate the wheels, make sure that the same wheels are always on the same side of the car.

NOTE: Please consult state or provincial regulations restricting the use of studded winter tires before installing such tires.

* Where permitted.

pg. 86 Wheels and tires

Checking and correcting tire pressure

- Check the tire pressure when refuelling.
- The tire pressure should be corrected only when the tires are cold.
- With warm tires, correct only when the pressure is too low. The tire temperature rises after driving just a few miles.

Tire rotation

Volvo recommends rotating the tires every 7,500 miles (12,000 km) and 15,000 miles (24,000 km). Tires should be

rotated front-to-back/back-to-front only. Tires must maintain the same direction of rotation throughout their lifetime, and should never be rotated from one side of the vehicle to the other.

Vehicle loading

The tires on your Volvo will perform to specifications at all normal loads when inflated as recommended on the tire information label* located on the rear facing edge of the passenger's door. This label lists both tire and vehicle design limits.

Do not load your car beyond the load limits indicated.

*Please note that the tire information label indicates pressure for both comfort and fuel economy.

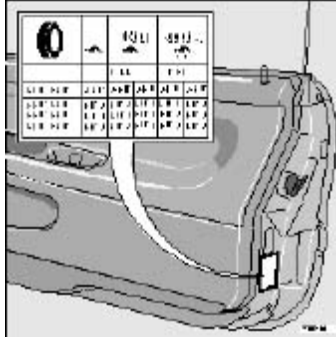

Tire pressure label

pg. 87 Wheels and tires

Uniform tire quality grading

ALL PASSENGER CAR TIRES MUST CONFORM TO FEDERAL SAFETY REQUIREMENTS IN ADDITION TO THESE GRADES

TREADWEAR

The treadwear grade is a comparative rating based on the wear rate of the tire when tested under controlled conditions on a specified government test course. For example, a tire graded 150 would wear one and one half (1 1/2) times as well on the government course as a tire graded 100. The relative performance of tires depends upon the actual conditions of their use, however, and many depart significantly from the norm due to variation in driving habits, service practices and differences in road characteristics and climate.

TRACTION

The traction grades, from highest to lowest, are AA, A, B, and C, as measured under controlled conditions on specified government test surfaces of asphalt and concrete. A tire marked C may have poor traction performance.

WARNING!

The traction grade assigned to this tire is based on braking (straight-ahead) traction tests and does not include cornering (turning) traction.

TEMPERATURE

The temperature grades are AA (the highest), A, B, and C, representing the tire's resistance to the generation of heat and its ability to dissipate heat when tested under controlled conditions on a specified indoor laboratory test wheel. Sustained high temperature can cause the material of the tire to degenerate and reduce tire life, and excessive temperature can lead to sudden tire failure. The grade C corresponds to a minimum level of performance that all passenger car tires must meet under the Federal Motor Safety Standard No. 109. Grades B and A represent higher levels of performance on the laboratory test wheel than the minimum required by law.

WARNING!

The temperature grade for this tire is established for a tire that is properly inflated and not overloaded. Excessive speed, underinflation, or excessive loading, either separately or in combination, can cause heat buildup and possible tire failure.

pg. 88 This page left intentionally blank



[Contents](#) | [Top of Page](#)

**2002
VOLVO
C70 Coupe & Convertible**

Chapter 6 - In case of an emergency

pg. 89 In case of an emergency

	Page
Wheel changing	90
Spare tire	92
Replacing bulbs	93
Replacing fuses	99
Installation of accessories	102
Replacing wiper blades	103
In case of emergency	105

pg. 90 Wheel changing

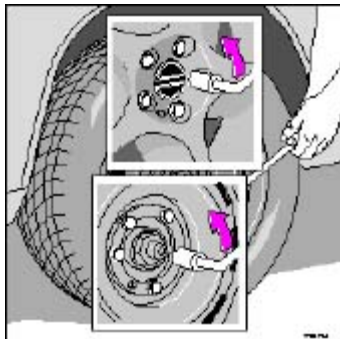

Loosen wheel bolts

Changing a wheel

The spare wheel is located under the carpet on the trunk floor. The jack and crank are secured in the wheel recess.

- Engage the parking brake.
- Put the gear selector in (P)ark (automatic) or in Reverse (manual).
- With the car still on the ground, use the lug wrench to loosen the wheel bolts 1/2 1 turn. Turn the bolts counterclockwise to loosen.
- Fold out the crank handle on the jack by pressing the knob on the handle downward. To attach the jack, refer to the

illustration on the following page.

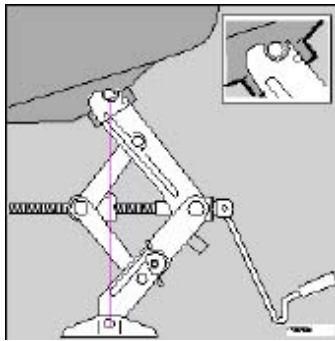

Jack attachment

There is a jack attachment located in the center on each side of the car. Position the jack on the bar in the attachment as shown in illustration above and crank while simultaneously guiding the base of the jack to the ground. **The base of the jack must be flat on a level, firm, non-slippery surface. Before raising the car, check that the jack is still correctly positioned in the attachment.** Raise the vehicle until both wheels on the side of the car where the jack is attached are lifted off the ground. Unscrew the wheel bolts completely and carefully remove the wheel so as not to damage the thread on the studs.

NOTE: To avoid excessive wear and the necessity of rebalancing, mark and reinstall wheels in the same location and position as before removal. To lessen the chance of imbalance, each wheel hub is equipped with a guide stud to ensure that a removed wheel can be reinstalled in its original position (as when changing over to winter tires/wheels).

CAUTION: The car must not be driven with wheels of different dimensions or with a spare tire other than the one that came with the car. The use of different size wheels can seriously damage your car's transmission.

pg. 91 Wheel changing

WARNING!

- The jack's attachment must engage the bar in the jack attachment (A). The car's weight must not rest on the jack attachment (B).
- Be sure the jack is on a firm, level, non-slippery surface.
- Never allow any part of your body to be extended under a car supported by a jack.
- Use the jack intended for the car when replacing a wheel. For any other job, use stands to support the side of the car being worked on. -
- Apply the parking brake, select position P (automatic transmission) or Reverse gear (manual transmission).
- Block the wheels standing on the ground, use rigid wooden blocks or large stones.
- The jack should be kept well-greased.

Installing the wheel

Clean the contact surfaces on the wheel and

hub. Lift the wheel and place it on the hub. Make sure that you align the wheel with the guide stud on the wheel hub prior to installation. Install the wheel bolts crosswise (see illustration) and tighten by turning lightly clockwise. Lower the vehicle to the ground and alternately tighten the bolts to 100 ft. lbs. (130 Nm). Install the wheel cap (where applicable).

CAUTION: Correct tightening torque on wheel bolts must be observed. The wheel bolts should never be greased or lubricated. The extended, chromed wheel bolts must not be used with steel rims, as they make it impossible to fit the hub caps.



Correct tightening order for wheel bolts

pg. 92 Spare tire

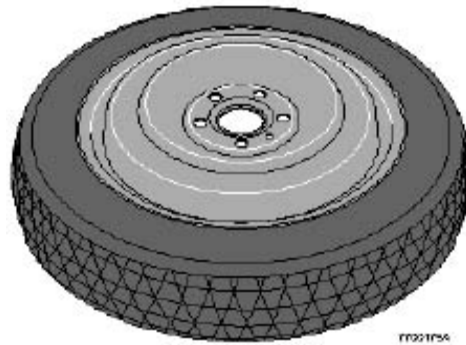

Temporary Spare (certain models)

The spare tire in your car is called a "Temporary Spare". It has the following designation: T125/90 R15.

Recommended tire pressure (see decal on fuel filler flap) should be maintained irrespective of which position on the car the Temporary Spare tire is used on.

In the event of damage to this tire, a new one can be purchased from your Volvo retailer.

CAUTION: The car must not be driven with wheels of different dimensions or with a spare tire other than the one that came with the car. The use of different size wheels can seriously damage your car's transmission.

WARNING!

Current legislation prohibits the use of the "Temporary Spare" tire other than as a temporary replacement for a punctured tire. In other words, it must be replaced as soon as possible by a standard tire. Roadholding, etc., may be affected with the "Temporary Spare" in use. Do not, therefore, exceed 50 mph (80 km/h).

pg. 93 Replacing bulbs

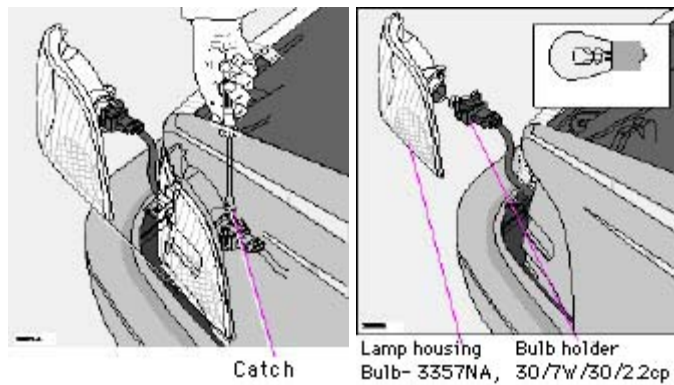

Parking light/direction indicator

1. From the front of the car, use a screwdriver to press down on the silver catch (located in the space between the inside of the fender and the headlight unit) to release the lamp housing from the front fender.
2. Turn the bulb holder 1/4 turn clockwise (viewed from the front) and withdraw it from the from the lamp housing. Leave the connector with its wires in the bulb holder.
4. Remove the bulb from the holder by pulling it straight out.
5. Press a new bulb into the holder and reinstall the unit in the reverse order.

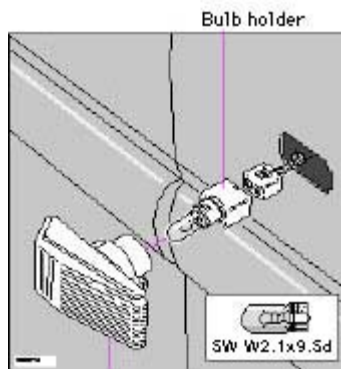

Side direction indicator

1. Slide the lens forward and pull out the rear edge.
2. Pull out the entire lens/bulb unit.
3. With the lens toward you, turn the bulb holder 1/4 turn (the wires should not be disconnected from the holder) and pull out the bulb holder from the lens unit.
4. Pull the old bulb straight out and press a new one into place.
5. Replace the entire unit in the reverse order.

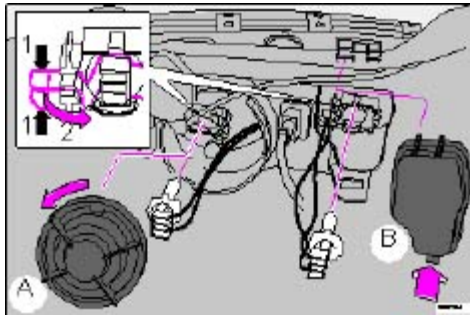

A - Low beam Bulbs (high and low beams) - H7 B - High beam

Low beam headlight bulb (A) replacement

1. Turn the plastic cover counterclockwise and remove it.
2. Press the wire catches on the retaining clamp (1 in inset illustration above) together and push out (2) to release the bulb and connector from the headlight housing.
3. Pull the bulb out of the connector.
4. Insert a new bulb into the connector.
5. Reinsert the bulb and connector into the headlight housing. The guide lug must be *up* to ensure proper positioning.
6. Press the retaining clamp back into position.
7. Reinstall the plastic cover. The marking "Top" on the cover should be up when the cover is reinstalled.

High beam headlight bulb (B) replacement

1. Pull the catch on the lower edge of the cover upward and remove the plastic cover.
2. Press the wire catches on the retaining clamp (1 in inset illustration above) together and push out (2) to release the bulb and connector from the headlight housing.
3. Pull the bulb out of the connector.
4. Insert a new bulb into the connector.
5. Reinsert the bulb and connector into the headlight housing. The guide lug must be *up* to ensure proper positioning.
6. Press the retaining clamp back into position.
7. Reinstall the plastic cover. Catch B should snap into position.

Caution! Do not touch the glass on halogen bulbs with your fingers. Grease, oil or any other impurities can be carbonized onto the bulb and cause damage to the reflector.

Be sure to use bulbs of the correct type and voltage

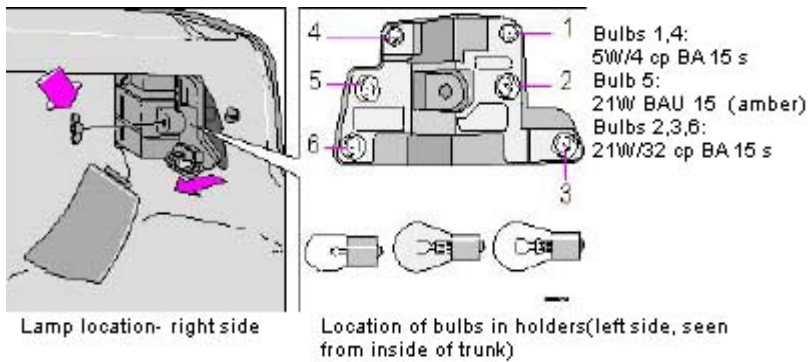

Tail light bulbs

1. Tail light
2. Direction indicator
3. Brake light
4. Tail light
5. Backup light
6. Rear fog light (left side only)

All the bulbs in the tail light unit are replaced from inside the trunk as follows:

1. Turn the plastic screw and remove the cover over the rear lamp unit.
2. Remove the wing nut and remove the bulb holder.
3. Let the connector with its wires remain attached to the bulb holder.
4. Remove the bulb by pressing in and turning counterclockwise.
5. Insert a new bulb into the holder and reinstall the holder into the tail light assembly.
6. Close the cover.

pg. 96 Replacing bulbs

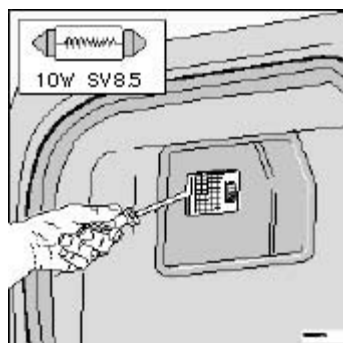

Insert screwdriver and turn

Trunk light

- Switch off the lights.
- Press in the catch with a screwdriver and remove the bulb holder.
- Replace the bulb and reinstall the bulb holder.

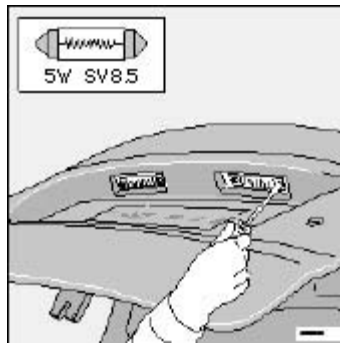

License plate lights

- Switch off the lights.
- Unscrew the screw.
- Insert the screwdriver and turn gently to loosen the glass lens.
- Replace the bulb and reinstall the glass lens.

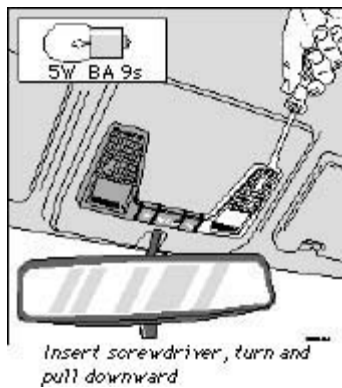

Front courtesy lights - C70 Coupe

- Switch off the ignition.
- Insert a screwdriver and turn carefully to loosen the glass lens.
- Replace the bulb and press the glass lens back into place.

pg. 97 Replacing bulbs

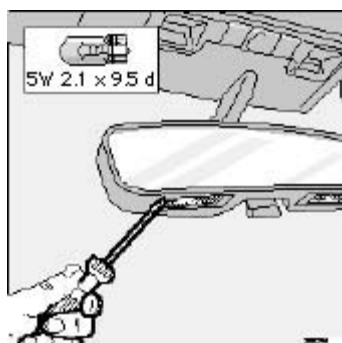

Insert screwdriver and turn

Front courtesy lights - C70 Convertible

- Switch off the ignition.
- Insert a screwdriver and turn carefully to loosen the glass lens.
- Replace the bulb and press the glass lens back into place.

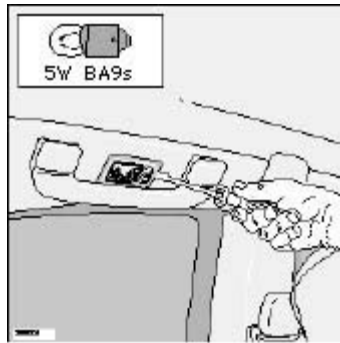

Insert a screwdriver and turn

Rear reading lights - C70 Coupe only

- Switch off the ignition.
- Insert a screwdriver and turn to loosen the lamp unit.
- Replace the bulb and press the lamp unit back into place.

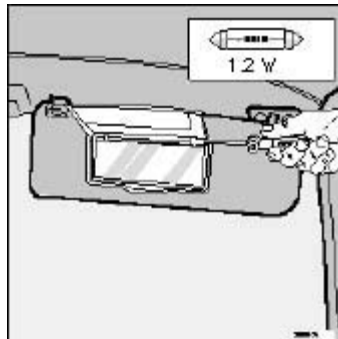

Insert a screwdriver and turn

Vanity mirror

- Switch off the ignition.
- Insert the screwdriver and turn gently to loosen the glass lens.
- Replace the bulb.
- Press the glass lens into place.



2002 VOLVO C70 Coupe & Convertible

Chapter 7 - Car care

pg. 107 Car care

	Page
Paint touch-up	108
Washing	110
Cleaning the convertible top, Polishing and waxing	111
Cleaning the upholstery	112

pg. 108 Paint touch up

Paint touch-up

Paint damage requires immediate attention to avoid rusting. Make it a habit to check the finish regularly when washing the car for instance. Touchup if necessary.

Paint repairs require special equipment and skill. Contact your Volvo retailer for any extensive damage.

Minor scratches can be repaired by using Volvo touchup paint.

NOTE: When ordering touchup paint from your Volvo retailer, use the paint code indicated on the model plate. The plate is located in the engine compartment, on the inside of the left front fender.

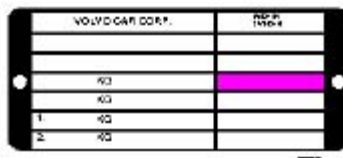

Minor stone chips and scratches

Material:

Primer can

Paint touchup bottle

Brush

Masking tape

NOTE: When touching up the car, it should be clean and dry. The surface temperature should be above 60° F (15° C).

Scratches on the surface

If the stone chip has not penetrated down to the metal and an undamaged layer of paint remains, the touchup paint can be applied as soon as the spot has been cleaned.

pg. 109 Paint touch up

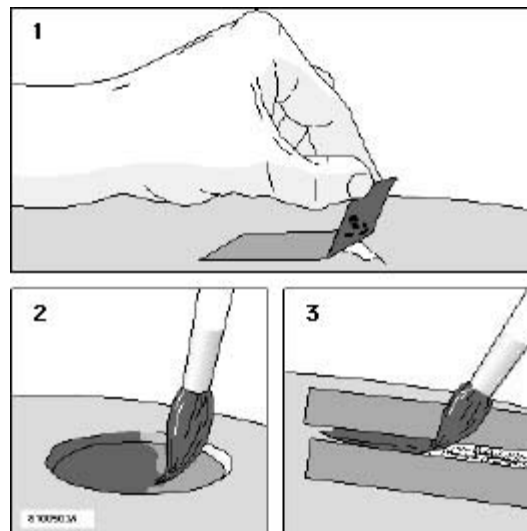

Deep scratches

1. Place a strip of masking tape over the damaged surface. Pull the tape off so that any loose flakes of paint adhere to it.
2. Thoroughly mix the primer and apply it with a small brush. When the primer surface is dry, the paint can be applied using a brush. Mix the paint thoroughly; apply several thin paint coats and let dry after each application.
3. If there is a longer scratch, you may want to protect surrounding paint by masking it off.

pg. 110 Washing

Washing the car

- The car should be washed at regular intervals since dirt, dust, insects and tar spots adhere to the paint and may cause

damage.

It is particularly important to wash the car frequently in the wintertime to prevent corrosion, when salt has been used on the roads.

- When washing the car, do not expose it to direct sunlight. Use lukewarm water to soften the dirt before you wash with a sponge, and plenty of water, to avoid scratching.
- **Bird droppings:** Remove from paintwork and the convertible top as soon as possible. Otherwise the finish may be permanently damaged.
- A detergent can be used to facilitate the softening of dirt and oil.
- A water-soluble grease solvent may be used in cases of sticky dirt. However, use a wash place equipped with a drainage separator.
- Dry the car with a clean chamois and remember to clean the drain holes in the doors and rocker panels *.
- The power radio antenna must be dried after washing.
- Tar spots can be removed with kerosene or tar remover after the car has been washed.
- A stiff-bristle brush and lukewarm soapy water can be used to clean the wiper blades. Frequent cleaning improves visibility considerably.
- Wash off the dirt from the underside (wheel housings, fenders, etc.).
- In areas of high industrial fallout, more frequent washing is recommended.

CAUTION: During high pressure washing, the spray mouthpiece must never be closer to the painted surfaces of the vehicle than 13" (30 cm). Do not spray directly into the locks, around the edges of the convertible top or the edges of the top's storage cover.

- When washing or steam cleaning the engine, avoid spraying water or steam directly on the electrical components or toward the rear side of the engine.
- After cleaning the engine, the spark plug wells should be inspected for water and blown dry if necessary.

Suitable detergents

Special car washing detergents should be used. A suitable mixture is about 2.5 fl. oz. (8.5 cl) of detergent to 2.6 US gal. (10 liters) of warm water. After washing with a detergent the car should be well rinsed with clean water.

WARNING!

- When the car is driven immediately after being washed, apply the brakes several times in order to remove any moisture from the brake linings.
- Engine cleaning agents should not be used when the engine is warm. This constitutes a fire risk.

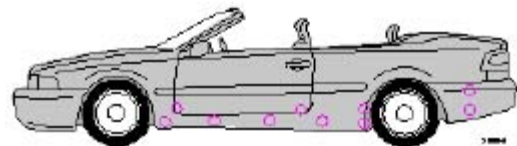

Volvo offers an environmentally friendly Car Care Kit, containing waxing, washing, and degreasing agents.

NOTE: When washing the car, remember to remove dirt from the drain holes in the doors and sills.

Bumpers: Wash the bumpers with the same cleaning agent used on the rest of the car. Never clean the bumpers with

gasoline or paint thinner. Difficult spots can be removed with denatured alcohol. To avoid scratches, do not dry the bumpers with paper.

See your local Volvo retailer for a complete line of genuine Volvo environmental car care products.

* Pay special attention to the drain holes near the base of the windshield in the cowl under the rear edge of the hood.

pg. 111 Automatic car washing, Polishing and waxing

Automatic washing simple and quick

An automatic wash is a simple and quick way to clean your car, but it is worth remembering that it may not be as thorough as when you yourself go over the car with sponge and water. Keeping the underbody clean is most important, especially in the winter. Some automatic washers do not have facilities for washing the underbody.

Before driving into an automatic wash, make sure that side view mirrors, auxiliary lamps, etc., are secure, otherwise there is risk of the machine dislodging them. **You should also lower the antenna by turning off the radio.**

We do NOT recommend washing your car in an automatic wash during the first six months (because the paint will not have hardened sufficiently).

Cleaning the convertible top - C70 Convertible

CAUTION:

Some automatic car washes can damage the convertible top. For this reason, we recommend washing the car by hand only.

Remember that the windows are lowered slightly when the convertible top is raised. Be sure the windows are closed and the convertible top is completely raised and properly in place at the upper edge of the windshield before washing the car. A chime indicates when the top has been fully raised (see [page 44](#)).

-
- Wash the convertible top with a mild detergent, wiping from the front towards the rear. Rinse thoroughly with clean water.
 - Do not wash the convertible top with a high pressure spray.
 - After washing, the convertible top should be completely dry before it is folded down.
 - Remove bird droppings from the convertible top as soon as possible. Otherwise the top may be permanently stained.
 - A soft brush can be used to clean the convertible top between washings.
 - Winter: remove any residue of road salt from the convertible top as soon as possible.
 - Do not use solvents, tar remover or other all-purpose stain removers to clean the convertible top. Use Volvo approved cleaning agents only - consult your Volvo retailer.

Polishing and waxing

- Normally, polishing is not required during the first year after delivery, however, waxing may be beneficial.
- Before applying polish or wax the car must be washed and dried. Tar spots can be removed with kerosene or tar remover. Difficult spots may require a fine rubbing compound.
- After polishing use liquid or paste wax.
- Several commercially available products contain both polish and wax.
- Waxing alone does not substitute for polishing a dull surface.

- A wide range of polymerbased car waxes can be purchased today. These waxes are easy to use and produce a longlasting, highgloss finish that protects the bodywork against oxidation, road dirt and fading.

Cleaning the upholstery

The **fabric** can be cleaned with soapy water or a detergent. For more difficult spots caused by oil, ice cream, shoe polish, grease, etc., use a clothing/fabric stain remover.

The **plastic** in the upholstery can be cleaned with a soft cloth and Volvo plastic-rubber cleaner.

Leather upholstery can be cleaned with a soft cloth and mild soap solution. For more difficult spots, Volvo offers a leather care kit.

On no account must gasoline, naphtha or similar cleaning agents be used on the plastic or the leather since these can cause damage.

Cleaning the seat belts

Clean only with lukewarm water and mild soap solution.

Cleaning floor mats

The floor mats should be vacuumed or brushed clean regularly, especially during winter when they should be taken out for drying. Spots on textile mats can be removed with a mild detergent.

Bear in mind

- Take extra care when removing stains such as ink or lipstick since the coloring can spread.
- Use solvents sparingly. Too much solvent can damage the seat padding.
- Start from the outside of the stain and work toward the center.



**2002
VOLVO
C70 Coupe & Convertible**

Chapter 8 - Volvo Service

pg. 113 Volvo Service

	Page
Label information	114
Maintenance service, Warranty	115
Servicing	116
Emissions maintenance	117
Fuel/emissions systems	118
Lubrication	119
Engine oil	120
Power steering fluid, Brake/clutch system fluid reservoir	122
Washer fluid reservoir	123
Coolant	124
Engine compartment	125
Battery maintenance/ Proposition 65 Warning	126
Three-way catalytic converter	127

pg. 114 Label information

1 Vehicle Emission Control Information

Your Volvo is designed to meet all applicable emission standards, as evidenced by the certification label on the underside of the hood. For further information regarding these regulations, please consult your Volvo retailer.

2 Vacuum hose routing

(underside of hood)

3 Loads and Tire Pressures

(on rear edge of passenger's door)

4 Model plate

Vehicle Identification Number (VIN). Codes for color and upholstery, etc. This plate is located in the engine compartment, on the inside of the left front fender.

5 Vehicle Identification Number (VIN) *

The VIN plate is located on the top left surface of the dashboard. The VIN is also stamped on the right hand door pillar.

6 Federal Motor Vehicle Safety Standards (FMVSS) specifications (USA) and Ministry of Transport (CMVSS) standards (Canada)

Your Volvo is designed to meet all applicable safety standards, as evidenced by the certification label on the rear edge of the driver's door. For further information regarding these regulations, please consult your Volvo retailer.

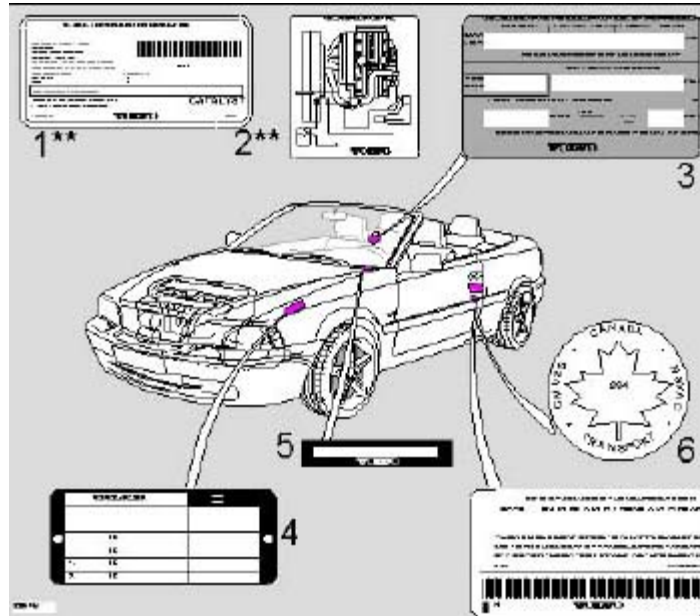

* The Vehicle Identification Number (VIN) should always be quoted in all correspondence concerning your vehicle with the retailer and when ordering parts.

** These decals are located on the underside of the hood.

All specifications are subject to change without notice.

pg. 115 Maintenance service, Warranty

Maintenance service

Volvo advises you to follow the service program which is outlined in the Warranty and Service Records Information Booklet. This maintenance program contains inspections and services necessary for the proper function of your car. The maintenance services contain several checks which require special instruments and tools and therefore must be performed by a qualified technician. To keep your Volvo in top condition, specify time tested and proven Genuine Volvo Parts and Accessories.

The Federal Clean Air Act U.S.

The Clean Air Act requires vehicle manufacturers to furnish written instructions to the ultimate purchaser to assure the proper functioning of those components that control emissions. The maintenance instructions listed in the "Servicing"

section of this Manual represent the minimum maintenance required. These services are not covered by the warranty. You will be required to pay for labor and material used. Refer to your Warranty and Service Records Information Booklet for further details.

Maintenance services

Your Volvo has passed several major inspections before being delivered to you, according to Volvo specifications. The maintenance services outlined in this book should be performed as indicated. The extended maintenance service intervals make it even more advisable to follow this program. Inspection and service should also be performed any time a malfunction is observed or suspected. It is recommended that receipts for vehicle emission services be retained in the event that questions arise concerning maintenance. Please refer to the Service Maintenance Record section of the Warranty and Service Records Information Booklet.

Inspection and service should also be performed anytime a malfunction is observed or suspected.

[Page 117](#) provides more information about maintenance of emission-related components.

Applicable warranties U.S.

In accordance with U.S. Federal Regulations, the following list of applicable U.S. warranties is provided. For Canadian specification vehicles, see your separate warranty booklet.

- New Car Limited Warranty- U.S.
- New Car Warranty - Canada
- Parts and Accessories Limited Warranty
- Corrosion Protection Limited Warranty
- Seat Belt and Supplemental Restraint Systems Limited Warranty-U.S.
- Seat Belt and Supplemental Restraint Systems Warranty -Canada
- Emission Performance Warranty -U.S. and Province of British Columbia only
- Emission Design and Defect Warranty

These are the Federal warranties; other warranties are provided as required by laws in your state or province. Refer to your separate Warranty and Service Records Information Booklet for detailed information concerning each of the warranties.

pg. 116 Servicing

Hoisting the car

If a garage jack is used to lift the car, the two jack attachments points should be used. They are specially reinforced to bear the weight of the car. A garage jack can also be placed under the front of the engine support frame and under the reinforced plate in the spare wheel well. Take care not to damage the splash guard under the engine. **Ensure that the jack is positioned so that the car cannot slide off it. Always use axle stands or similar structures.**

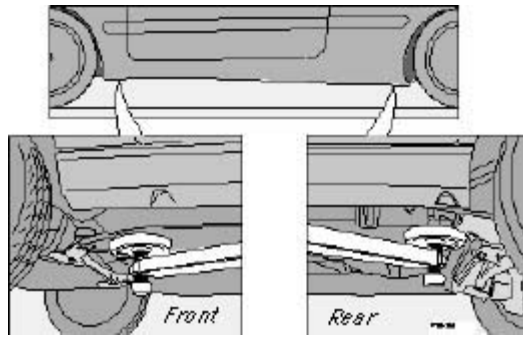

If a two-post hoist is used to lift the car, the front lift arm pads should be positioned under the rear engine frame mounts. The rear lift arm pads should be positioned under the rear supporting arm bracket.

CAUTION: Certain models have reduced ground clearance due to the design of the front spoiler. Please observe caution when driving the car onto a garage hoist.

pg. 117 Emission Maintenance

Periodic maintenance helps minimize emissions

Periodic maintenance will help keep your vehicle running well. Your Warranty and Service Records Information booklet provides a comprehensive periodic maintenance schedule up to 150,000 miles (240,000 km) of vehicle service. The schedule includes components that affect vehicle emissions. This page describes some of the emission-related components.

Engine air filter

The engine air filter cleans particles from air entering the engine. Replace the engine air filter cartridge with a new one every 37,500 miles (60,000 km) under normal driving conditions. Replace the cartridge more often when the vehicle is driven under dirty and dusty conditions. The cartridge cannot be cleaned, and should always be replaced with a new one.

Fuel filter

The fuel filter should be replaced at 105,000 miles (168,000 km). The filter is replaced as a complete unit. Replace more frequently if contaminated fuel is introduced into the tank, or if there is reason to suspect that this has occurred.

Fuel system, including filler cap, tank and lines and connections

The ability of the fuel system to contain hydrocarbons depends upon a leak-free system. Inspect fuel lines every 30,000 miles (48,000 km). Check for proper sealing of the fuel filler cap which contains "O" ring seals.

NOTE: If the fuel filler cap is not closed tightly or if the engine is running when the car is refueled, the Check Engine light ("Malfunction indicator") may indicate a fault. However, your vehicle's performance will not be affected. Use only Volvo original or approved fuel filler caps.

Timing belt

For proper functioning of the vehicle and its emission control systems, the timing belt and belt tensioner must be replaced every 105,000 miles (168,000 km). Engine damage will occur if the belt fails.

PCV system

(on turbocharged models)

The nipple in the intake manifold and the filter at the end of the PCV hose in the air cleaner should be inspected and cleaned at 105,000 miles (168,000 km) and thereafter, again at 150,000 mile (240,000 km) intervals.

Spark plugs

The spark plugs should be replaced every 60,000 miles (96,000 km) under normal driving conditions. City driving or fast highway driving may necessitate replacement sooner.

Under normal driving conditions, spark plugs require no maintenance between replacement intervals. When installing new plugs, be sure to use the right type and to tighten them correctly. When changing the plugs, clean the terminals and rubber seals. Also check that the suppressor connectors are in good condition. Cracked or damaged connectors should be replaced.

pg. 118 Fuel/emissions systems

Fuel system

The fuel system is allelectronic and is microprocessorcontrolled. It can continually compensate for variation in engine load, speed and temperature to give the best economy and power. A mass air flow sensor measures the inducted air. In this way the system can make instantaneous adjustments for changes in air temperature or density, thus always assuring the best economy with the lowest possible exhaust emissions.

Heated oxygen sensor(s)

This is an emission control system designed to reduce emissions and improve fuel economy. The heated oxygen sensor monitors the composition of the exhaust gases leaving the engine. The exhaust gas analysis is fed into an electronic module. This adjusts the airfuel ratio to provide optimum conditions for combustion and efficient reduction of the three major pollutants (hydrocarbons, carbon monoxide and oxides of nitrogen (NO_x) by a threeway catalytic converter.



Crankcase ventilation

Crankcase ventilation

The engine is provided with positive crankcase ventilation which prevents crankcase gases from being released into the atmosphere. Instead, the crankcase gases are admitted to the intake manifold and cylinders.

Evaporative control system

The car is equipped with an evaporative control system which prevents gasoline vapor from being released into the atmosphere.

The system consists of a fuel tank with filler pipe and cap, a rollover valve, a Fill Limit Vent Valve (FLVV), vapor vent lines, a charcoal canister, a purge line, a purge control valve and engine connections .

In addition, there is a pressure sensor connected to the fuel tank and a filter-protected Canister Close Valve (CCV) on the atmospheric side of the canister, for system diagnosis.

The gasoline vapor is channeled through the rollover valve and the FLVV via the vapor vent lines into the charcoal canister, where it is stored. When the engine is started, the gasoline vapor is drawn from the charcoal canister to the engine's air intake system and into the combustion process.

NOTE:

- If the fuel filler cap is not closed tightly or if the engine is running when the car is refueled, the Malfunction Indicator Lamp may indicate a fault.
- During a transitional period, a small number of service stations may still have fuel nozzles that are not compatible with the fuel filler neck on cars equipped with the evaporative control system (ORVR) mandated by the U.S. Environmental Protection Agency and the California Air Resources Board. If you experience difficulties in refueling your vehicle, please ask the gas station attendant for assistance.

CAUTION:

Fuel must not be siphoned from the fuel tank. This will damage the Evaporative control system.



[Contents](#) | [Top of Page](#)

**2002
VOLVO
C70 Coupe & Convertible**

Chapter 9 - Specifications

pg. 129 Specifications

	Page
Oil/fluids specifications	130
Engine specifications	131
Cooling/fuel/distributor ignition systems	132
Front/rear suspensions	132
Transmission, Capacities, Vehicle loading	133
Electrical system/bulbs	134
Dimensions and weights	135
Service manuals, Road assistance	136

pg. 130 Oil/fluid specifications

Engine Oil

Meeting or exceeding ILSAC specification GF-2, including ACEA A1, API SJ, SJ/CF, and SJ/Energy Conserving.

Oil additives must not be used.

Engine oil	Quality: Meeting API SJ, SJ/CF, and SJ/Energy Conserving.	Capacity (incl. filter): 6.2 US qts. (5.8 liters)
Automatic transmission fluid	Quality: AW5. Only Volvo gearbox oil (1161540-8). Do not mix with other oils..	Capacity: 8 US qts. (7.5 liters)
Manual transmission fluid	Quality: Volvo synthetic gearbox oil 1161423	Capacity: 2.2 US qts. (2.1 liters)
Power steering fluid	Quality: ATF	Capacity: 0.95 US qts. (0.9 liters)
Brake fluid	Quality: DOT 4+ boiling point > 536°F (280°C), P/N 9437433	Capacity: 0.64 US qts. (0.6 liters)

All specifications are subject to change without notice.

Engine

Liquid-cooled gasoline, 5-cylinder, in-line engine. Aluminum alloy cylinder block with cast iron cylinder liners cast directly into the block. Aluminum alloy cylinder head with double overhead camshafts and separate intake and outlet channels.

Engine lubrication is provided by an eccentric pump driven from the crankshaft. Fullflow type oil filter. Exhaust emission control is accomplished by multiport fuel injection, heated oxygen sensor(s) and threeway catalytic converter.

Charge air cooler (Intercooler)

Turbocharged engines employ a turbocompressor to force air into the engine inlet manifold and a charge air cooler to cool the compressed inlet air. The resulting increase in air flow raises pressure in the intake manifold by approx. 8.7 psi (over atmospheric pressure) and engine power output by approx. 50 horsepower over that developed by the normally aspirated engine. The charge air cooler (which resembles a radiator) is located between the turbocompressor and inlet manifold.

Designation: **Volvo B 5234 T3**

Output	236 hp at 5400 rpm (176 kw/90 rps)
Max. torque	243 ft. lbs. at 2400-5100 rpm (330 Nm/40-92 rps)
Number of cylinders	5
Bore	3.19" (81 mm)
Stroke	3.54" (90 mm)
Displacement	2.3 liters
Compression ratio	8.5:1
Number of valves	20

Designation: **Volvo B 5244 T**

Output	190 hp at 5100 rpm (142 kw/85 rps)
Max torque	199 ft. lbs. at 1800-5000 rpm (270 Nm/27-83 rps)
Number of cylinders	5
Bore	3.27" (83 mm)
Stroke	3.54" (90 mm)
Displacement	2.4 liters
Compression ratio	9.0:1
Number of valves	20

All specifications are subject to change without notice.

Cooling system

Type: Positive pressure, closed system

Thermostat begins to open at 180° F (87° C)

Coolant: Volvo original coolant/antifreeze

Capacity: 7.4 US qts. (7.0 liters)

Fuel system

The engine is equipped with a multiport fuel injection system.

Distributor ignition system

Firing order: 12453

Distributor ignition setting: Not adjustable

Spark plugs: Champion RC8PYP (or equivalent)

Spark plug gap: 0.03" (0.75 mm)

Tightening torque: 18.4 ft. lbs. +/- 3.7 ft. lbs. (25 Nm +/- 5 Nm)

WARNING!

The distributor ignition system operates at very high voltages. Special safety precautions must be followed to prevent injury. Always turn the ignition off when:

- Replacing distributor ignition components e.g. plugs, coil, etc.
- Do not touch any part of the distributor ignition system while the engine is running. This may result in unintended movements and body injury.

All specifications are subject to change without notice.

Front suspension

Spring strut suspension with integrated shock absorbers and control arms linked to the support frame. Powerassisted rack and pinion steering. Safety type steering column.

The alignment specifications apply to an unladen car but include fuel, coolant and spare wheel.

Toe-in measured on the wheel rims: 2.4 mm +/- 0.7 mm

Toe-in measured on tire sides: 2.9 +/- 0.9 mm

Rear suspension

Deltalink individual rear wheel suspension with longitudinal support arms, double link arms and track rods.

Toe-in measured on the tire sides: 4° +/- 10°

Power transmission

Manual transmission: M 56 H

Singledisc dry plate clutch. Allsynchromesh on all gears including reverse; integrated final drive. Operation via a floor mounted gear lever.

Final drive ratio 4.00:1

Reduction ratios

1st gear	3.07:1
2nd gear	1.77:1
3rd gear	1.19:1
4th gear	0.87:1
5th gear	0.70:1
Reverse	2.99:1

Automatic transmission: AW 55-50 LE

4 or 5-speed automatic electronically controlled gearbox comprising a hydraulic torque converter with a lockup function; planetary gear, integrated final drive.

Operation via a floor mounted gear selector lever. Drive shafts with symmetrical joint location. Overdrive.

Final drive ratio 2.44:1

Reduction ratios

1st gear	4.77:1
2nd gear	2.10:1
3rd gear	1.96:1
4th gear	1.32:1
5th gear	1.02:1
Reverse	3.23:1

Capacities

Fuel tank	17.9 US gals (68 liters)
Cooling system	7.4 US qts. (7.0 liters)
Engine oil (incl. filter)	6.1 US qts. (5.8 liters)
Automatic transmission	2 US gals (7.6 liters)
Manual transmission	2.2 US qts. (2.1 liters)
Power steering fluid	0.95 US qts (0.9 liters)
Washer fluid reservoir	4.7 US qts. (4.5 liters)
Brake/clutch system	0.6 US qts (0.6 liters)

Vehicle loading

The tires on your Volvo should perform to specifications at all normal loads when inflated as recommended on the tire information label. The label is located on the inside of the fuel filler flap. The label lists both tire and vehicle design limits. Do not load your car beyond the load limits indicated.

WARNING!

Improperly inflated tires will reduce tire life, adversely affect vehicle handling and can possibly lead to failure resulting in loss of vehicle control without prior warning.

All specifications are subject to change without notice.

pg. 134 Specifications

Electrical system

12 Volt, negative ground.

Voltagecontrolled generator. Singlewire system with chassis and engine used as conductors.

Battery

Voltage 12 Volt

Capacity 520 A/100 min

(certain markets) 420 A/75 min

The battery contains corrosive and poisonous acids. It is of the utmost importance that old batteries are disposed of correctly. Your Volvo retailer can assist you in this matter.

Generator

Rated output 1400 W

Max. current 100 A

Bulbs

Bulb	US no.	Power	Socket	No/bulbs
Headlights				
High beam	H7	55W	-	2
Low beam	H7	55W	-	2
Front parking lights/turn signals	3357NA	30/7W/30/2.2cp	W 2.5 x 15q	2
Turn signals, rear	-	21W	BAU 15	2
Side direction indicators	-	5W	W 2.1x9.5 d	2
Tail lights	67	5W/4cp	BA 15 s	4
Brake lights	1156	21W/32cp	BA 15 s	2
Backup lights	1156	21W/32cp	BA 15 s	2
Rear fog light	1156	21W/32cp	BA 15 s	1

Front fog lights	H1	55 W	P14.5s	2
License plate light	-	5 W	W 2.1x9.5d	2
Door open warning light	-	3 W	W 2.1x9.5d	4
Door step courtesy lights	-	5W	W 2.1x9.5d	2
Trunk light	-	10 W	SV 8.5	1
Glove compartment light	-	2 W	BA 9s	1
Vanity mirror lights	-	1.2 W	-	2
Instrument lighting	-	3 W	W 2.1x9.5d	3
Illumination, control panel	-	1.2 W	W 2x4.6 d	-
gear selector (automatic trans.)	-	1.2 W	W 2x4.6d	1
rear ashtray	-	1.2 W	W 2x4.6d	1
Instrument warning/indicator lights	-	1.2 W	W 2x4.6d	-
Front courtesy lights	-	5 W	BA 9s	2
Rear reading lights	-	5 W	BA 9s	2

All specifications are subject to change without notice.

pg. 135 Specifications

Dimensions

Length	185.8 in. (472 cm)
Width	71.7 in. (182 cm)
Height C70 Coupe	55.7 in. (141 cm)
Height C70 Convertible	56.3 in. (143 cm)
Wheelbase	105 in. (266 cm)
Track, front	59.9 in. (151.8 cm)
Track, rear	59.8 in. (151.6 cm)
Turning circle (between curbs)	38.4 ft. (11.7 m)
Cargo capacity	7.9 cu. ft. (0.22 m ³)

Weights -

	USA	Canada
Gross vehicle weight (GVW)		
C70 Coupe		
(Aut.)	4190 lbs (1900 kg)	1900 kg
(Man.)	4140 lbs (1878 kg)	1880 kg
C70 Convertible		
(Aut.)	4450 lbs (2018 kg)	2020 kg
(Man.)	4410 lbs (2000 kg)	2000 kg
Capacity weight *		
C70 Coupe	785 lbs (356 kg)	355 kg

C70 Convertible		
(B5234T3)	765 lbs (347 kg)	350 kg
(B5254T)	795 lbs (361 kg)	360 kg
Curb weight		
C70 Coupe	3305-3405 lbs (1499-1544 kg)	1500-1545 kg
C70 Convertible	3590-3685 lbs (1628-1671 kg)	1630-1675 kg
Permissible axle weight, front		
C70 Coupe		
(Aut.)	2360 lbs (1070 kg)	1070 kg
(Man.)	2310 lbs (1048 kg)	1050 kg
C70 Convertible		
(Aut.)	2440 lbs (1107 kg)	1110 kg
(Man.)	2400 lbs (1089 kg)	1090 kg
Permissible axle weight, rear		
C70 Coupe	1940 lbs (880 kg)	880 kg
C70 Convertible	2140 lbs (970 kg)	970 kg

WARNING!

When adding accessories, equipment, luggage and other cargo to your vehicle, the total loaded weight capacity of the vehicle must not be exceeded.

* The max permissible axle loads or the gross vehicle weight must not be exceeded.

** See also section "Trailer towing"

All specifications are subject to change without notice.

pg. 136 On Call Road Assistance



Volvo On Call Roadside Assistance

Your new Volvo comes with a four year On Call Roadside Assistance program.. Additional information, features, and benefits are described in a separate information package in your glove compartment.

If you have misplaced your package, dial:

In the U.S.A.

1-800-63-VOLVO (1-800-638-6586)

In Canada:

1-800-263-0475



Technician certification

In addition to Volvo factory training, Volvo supports certification by the National Institute for Automotive Excellence (A.S.E.). Certified technicians have demonstrated a high degree of competence in specific areas. Besides passing exams each technician must also have worked in the field for two or more years before a certificate is issued. These professional technicians are fully able to analyze vehicle problems and perform the necessary service procedures to keep your Volvo at peak operating condition.

All specifications are subject to change without notice.



[Contents](#) | [Top of Page](#)

**2002
VOLVO
C70 Coupe & Convertible**

Chapter 10 - Audio systems

pg. 137 Audio systems

	Page
SC-813	138
SC-816	151
SC-901	167
General information	190

pg. 138 Audio system SC-813 (certain models)

The following pages describe the use of your SC-813 Cassette radio and CD remote control

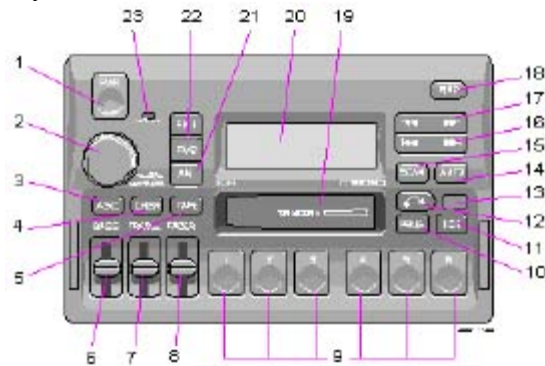

1. On/off (push)
2. Volume (turn)
- Pause/Mute (push)
- Balance (pull)
3. Active Sound Control
4. CD changer selector
5. Tape mode selector
- Tape direction selector PROG

6. Bass control
7. Treble control
8. Fader control
9. · Preset buttons
- CD-Disc No. selector
10. PROG - Reversing the tape
11. Dolby B NR button
12. Cassette eject
13. Not in use
14. Scan
15. Auto seek memory
16. · Seek tuning up/down
- **TP**-Next/Previous song
- **CD**-Next UP/Previous DOWN track
17. · Manual tuning
- **TP**-fast forward/Rewind
- **CD**-Music searchUP/DOWN
18. RND button
19. Cassette slot
20. Display
21. Waveband selector (AM)
22. Waveband selectors (FM)
23. Anti-theft LED

TP = Applicable only in Tape Mode

CD = Applicable only when in CD mode and connected to a CD changer.



Anti-theft code

The radio features anti-theft circuitry. If the set is removed from the vehicle or if the battery power is disconnected, a special code must be entered to enable operation of the set.

Refer to the radio code card supplied with your vehicle or ask your retailer for the correct code.

When the car is parked with the ignition key removed, the anti-theft LED will flash.



To enter the code

After installation or when the set has been disconnected from power, the set displays "COdE" when it is switched on.

Enter the 4-digit code using the preset buttons.

If the correct code is entered, "on" is displayed and the set is ready to use.

If you enter an incorrect code you must enter the correct code again from the beginning.



Incorrect code

If an incorrect code has been entered "rPt" is displayed. Enter the correct code.

After three unsuccessful coding attempts the set will lock and remain locked for two hours. "**OFF**" is displayed.

During this waiting period:

- the battery must be connected
- the ignition key must be turned to position I

· the unit must be turned on

Make sure the headlights are turned off to help prevent battery drain (please refer to [page 22](#) for information on turning the headlights off).

Enter the code again once this time has elapsed.

pg. 140 Radio SC-813



A - On/off switch

Push the button to switch on the radio. Press the button slightly longer to turn the radio off.

B - Volume control

Turn the button clockwise to increase the volume. The volume control is electronic and has no end stop.

C - Waveband selector

The desired waveband is set by pressing one of the waveband selector buttons. The frequency and waveband is shown on the display.

NOTE: There are two FM wavebands and one AM waveband. This makes it possible to store 2 x 6 FM stations and 6 AM stations in memory.

D - Setting frequency selection

The radio can be used in most parts of the world by changing the frequency selection intervals as follows:

Depress and hold preset button 5 and turn the radio ON. "USA" will flash on the display.

Each time button 5 is pressed, the frequency selection will change from "USA" to "AUS", etc. When the correct country name is displayed, wait 5 seconds and the radio will be ready for use.

E - Manual tuning

Press the left side tune button to tune to lower frequencies and the right side to tune to higher frequencies. The tuned frequency is displayed.

ST will be displayed to indicate stereo FM reception.

pg. 141 Radio SC-813

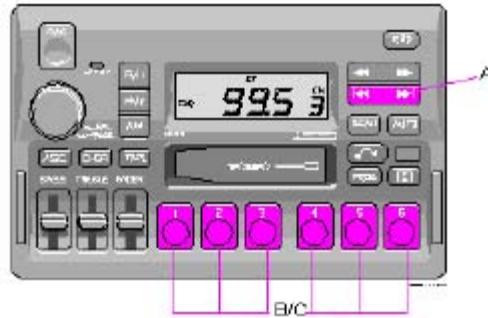

A - Seek tuning up/down

Press the left side tune button to tune to lower frequencies and the right side to tune to higher frequencies. The radio seeks the next audible station and stops there. If you wish to continue the seek tuning, press the tune button again.

B - Preset programming

1. Tune to the desired frequency.
2. Depress and hold a preset button. The audio will cut out. Keep the button depressed until the audio comes on again (approx. 2 seconds).
3. The frequency is now stored on this preset button.

C - Preset buttons

To select a pre-programed radio frequency, depress the preset button. The set frequency will be displayed.

pg. 142 Radio SC-813

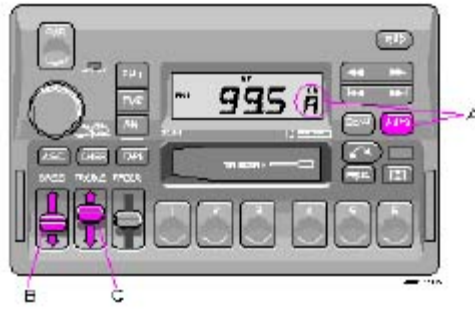

A - Automatic programming (Auto)

Please note that this function will not interfere with pre-stored stations on buttons 1-6.

This function automatically seeks and stores up to 8 strong AM or FM stations.

This is especially useful when travelling in areas where radio stations are unfamiliar.

1. Depress and hold the "AUTO" button for **at least 1 second**. A number of strong stations (max. 8) on the chosen waveband are now automatically stored in the memory.

If there are no audible stations, "- - -" is displayed.

2. Press the "AUTO" button (**for less than 1 second**) to obtain another autostored station. A new station will be selected each time the button is pressed momentarily.

B - Bass control

Adjust the bass by sliding the control up or down (up to increase, down to decrease).

A "detent" indicates "equalized" bass.

C - Treble control

Adjust the treble by sliding the control up or down (up to increase, down to decrease).

A "detent" indicates "equalized" treble.

pg. 143 Radio SC-813



A - Fader control

Adjust front/rear speaker balance by sliding the control up or down.

(**UP** to direct more sound to the front speakers, **DOWN** to direct more sound to the rear speakers).

The "detent" indicates "equalized" front /rear balance position.

B - Pause function

Press the "volume" knob to temporarily mute the sound. "PAUSE" is displayed.

C - Balance control

Pull out the "volume" knob and adjust the left/right balance by turning the knob counter- clockwise or clockwise.

D - Scan

Press this button to listen to each station for five seconds. Press it again to stop scanning. "Scan" will be displayed during scanning.

E - Active sound control (ASC)

The ASC function automatically adjusts the volume level of the audio system according to driving speed. To deactivate ASC depress the "ASC" button.

To activate ASC, depress the "ASC" button until "ASC" is displayed.

pg. 144 Cassette deck



A - Cassette slot

The cassette is inserted with the open side to the right (side 1 or A of the cassette upwards).

When the cassette is inserted, the radio is disengaged and the cassette will start to play automatically. "TAPE " or "TAPE " is displayed to indicate which side of the tape is being played. When one side of the tape has been played the unit will automatically play the other side (auto-reverse). The cassette can be inserted or ejected even when the unit is switched off.

B - Reversing the tape (PROG)

Press the button to play the other side of the tape.

The side of the tape being played will be displayed.

C - Fast winding

The tape is advanced with " ►► " and rewind with " ◀◀ ".

Fast winding can be stopped by pressing either the selected button or the fast wind button again or by pressing the "TAPE" button.

D - Dolby B NR button

Press this button when you use tapes recorded with the Dolby B noise reduction system.

The Dolby symbol  will be indicated in the display.

pg. 145 Cassette deck



A - Next selector

Press the " ►► " button and the tape will automatically advance to the next song.

There must be a gap (no audio sound) of approx. 5 seconds between songs for this function to operate.

B - Previous selector

Press the " ◀◀ " button and the tape will automatically rewind to the previous song.

There must be a gap (no audio sound) of approx. 5 seconds between songs for this function to operate.

C - Pause

If you press the "volume" knob the tape is stopped, the unit is silent and "PAUSE" is displayed. To restart the tape press the knob again.

D - Scan

Press this button to listen to the first five seconds of each song. Press this button or the "TAPE" button to stop scanning. During scanning "SCAN" will be displayed. There must be a gap (no audio sound) of approx. 5 seconds between songs for this function to operate.



[Contents](#) | [Top of Page](#)

2002 VOLVO C70 Coupe & Convertible

INDEX

pg. 194 HomeLink® Universal Transceiver (option)

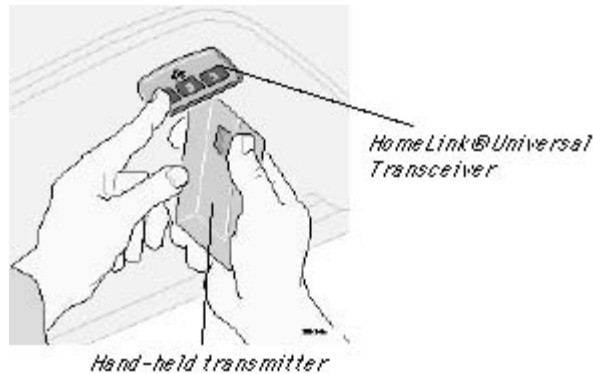

HomeLink® Universal Transceiver

HomeLink® is an advanced system that can be programmed to learn the codes of three different remote controlled-devices (e.g., garage door openers, remote lighting, entry door lock). HomeLink®'s sun visor-mounted transceiver, powered by your car's electrical system, may then be used in place of your hand-held remote controls.

NOTE: For your security, the HomeLink® Universal Transceiver is designed to **not** function if you lock your car from the *outside*.

Programming the transceiver

1. The ignition switch must be turned to the "accessory" position (II) before programming the HomeLink® Universal Transceiver.

Release the buttons.

2. Begin by erasing all 3 factory default channels. Hold down the two outside buttons (buttons 1 and 3 in the illustration) on the HomeLink® Universal Transceiver for about 20 seconds, until HomeLink®'s indicator light begins to flash. Then release the buttons.

3. Hold your hand-held transmitter (garage door opener, for example) 2 to 5 in. (5 to 12 cm) away from the HomeLink® surface, keeping the indicator light in view. For placement questions, contact HomeLink® toll-free 1-800-355-3515 (Internet: www.HomeLink.com).

4. Using two hands, push and hold both your hand-held transmitter's button and the transceiver button you wish to program. The indicator light will flash first slowly, then rapidly. Rapid flashing tells you the HomeLink® button has

been successfully programmed. Release both buttons.

5. If you are programming a rolling code-equipped device (e.g., garage door opener or entry door lock), refer to "Programming rolling codes" on the next page to complete the programming process.

Repeat steps 3 and 4 to program the other two transceiver buttons. If, after several attempts, you are unable to successfully train the HomeLink® Universal Transceiver to learn your hand-held transmitter's signal, contact HomeLink® toll-free 1-800-355-3515 (Internet: www.HomeLink.com).

WARNING!

- If you use HomeLink® to open a garage door or gate, be sure no one is near the gate or door while it is in motion.
- Do not use the HomeLink® Universal Transceiver with any garage door opener that lacks safety "stop" and "reverse" features as required by federal safety standards. (This includes any garage door opener model manufactured before April 1, 1982) A garage door opener that cannot "detect" an object, signalling the door to "stop" and "reverse" does not meet current federal safety standards. Using a garage door opener without these features increases the risk of serious injury or death. For more information on this matter, call toll-free 1-800-355- 3515 (Internet: www.HomeLink.com).

pg. 195 HomeLink® Universal Transceiver (option)

NOTE - Canadian residents:

During programming, your hand-held transmitter may automatically stop transmitting. To successfully train HomeLink®, continue to hold the HomeLink® button. At the same time, repeatedly press and hold your hand-held transmitter's button at two-second intervals until HomeLink® has learned your transmitter's code. The HomeLink® indicator light will flash first slowly, and then rapidly to indicate that the button has been successfully programmed.

Determining if your garage door uses a rolling code

Determining if your garage door uses a rolling code Determine, in one of the following ways, if your garage door uses a rolling code system and is manufactured after 1996:

- Refer to the garage door opener owner's manual for verification.
- If your hand-held transmitter appears to program the HomeLink® Universal Transceiver but the programmed button does not activate the garage door, your garage door opener may have a rolling code.
- Press the programmed HomeLink® button. If the garage door opener has the rolling code feature, the HomeLink® indicator light flashes rapidly and then glows steadily after approximately 2 seconds.

To train a rolling code garage door opener, follow these instructions after programming the desired transceiver button according to "Programming the transceiver." The help of a second person may make training easier.

1. Locate the training button on the garage door opener motor head unit. The location and color of the training button may vary. If you encounter difficulty, refer to the garage door opener owner's manual or call toll-free 1-800-355-3515 (Internet: www.HomeLink.com).
2. Press the "training" button on the garage door opener motor head unit until the "training" light comes on.
3. Press and release the programmed HomeLink® button. Press and release the programmed HomeLink® button a second time to complete the training process. Some garage door openers may require you to do this procedure a third time to complete the training.

The programmed button on your HomeLink® Universal Transceiver should now operate your garage door opener. The original hand-held transmitter can also be used, as desired, to operate the garage door. www.HomeLink.com).

Operating the HomeLink® Universal Transceiver Once programmed, the HomeLink® Universal Transceiver can be used in place of your hand-held transmitters.

To operate, the key must be turned to the "accessory" position (II) or the engine must be running. Press the programmed HomeLink® button to activate the garage door, driveway gate, security lighting, home security system, etc.

Your original hand-held transmitters may, of course, be used at any time.

Erasing programmed buttons

Individual buttons cannot be erased. To erase all three programmed buttons:

1. Turn the ignition key to the "accessory" position (II).
2. Hold down the two outside buttons on the HomeLink® Universal Transceiver for about 20 seconds, until HomeLink® 's indicator light begins to flash.
3. Release both buttons.

The HomeLink® buttons can be reprogrammed using the procedures described on the previous page.

(HomeLink® information is continued on the next page)

pg. 196 HomeLink® Universal Transceiver (option)

Reprogramming a single HomeLink® button

1. Press and hold the desired HomeLink® button. **Do not release** the button until step 3 has been completed.
2. When the indicator light begins to flash slowly (after approximately 20 seconds), position the hand-held transmitter 2 to 5 in. (5 to 12 cm) away from the HomeLink® surface.
3. Press and hold the hand-held transmitter button.

The HomeLink® indicator light will begin to flash, first slowly then rapidly. When the indicator light flashes rapidly, release both buttons.

The previously programmed device has now been erased and the new device can be activated by pressing the HomeLink® button that has just been programmed. This procedure will not affect any other programmed HomeLink® buttons.

NOTE:

- Retain the original transmitter(s) for future programming procedures (i.e., if you purchase a new car).
 - It is also suggested that if you sell your car, the programmed channels on the HomeLink® Universal Transceiver be erased for security purposes.
-



[Contents](#) | [Top of Page](#)

2 0 0 2
VOLVO
C70 Coupe & Convertible

INDEX

pg. 197 - 199 Index

A	
ABS	19
Air conditioning	37
Air filter- engine	117
Air mix	35
Air vents	35
Airbag (SIPS)	8
Airbag (SRS)	4
Alarm	48
Ambient temperature sensor	27
Anti-lock Brake System (ABS)	19,78
Antifreeze	81
Ashtrays	33
Audio systems	
-General information	190
-SC-813	138
-SC-816	151
-SC-901	167
Automatic car washing	111
Automatic daytime running	26
Automatic transmission	70,133
Driving mode selector	71
Automatic transmission fluid	130
B	
Battery	81,134
Battery drain - avoiding	61
Battery maintenance	126
Booster cushion	13
Brake failure warning light	19, 20
Brake fluid	122,130
Brake fluid warning light	20
Brake system	78, 79

Brake warning light	19
Bulb failure warning	19,21
Bulbs	134
C	
Capacities	133
Catalytic converter	127
Central locking button	38
Central locking system	47
Chains (snow)	85
Changing a wheel	90
Child booster cushion	11
Child Restraint Anchorages	11
Child safety	13
Cleaning the convertible top	111
Climate control systems	36
Clock	18
Clock - resetting	27
Clutch fluid	122
Clutch interlock	69
Convertible top - cleaning	111
Convertible top - electrically operated	44
Convertible top - manually raising	106
Coolant - checking/changing	124
Coolant level sensor	21
Coolant level warning light	19
Cooling system	73,132
Courtesy lights - exterior	22
Courtesy lights - front	54
Cruise control	31
D	
Daytime running lights	26
Demister - rear window	25
Dimensions	135
Distributor ignition system	132
Diversity antenna	193
Doors and locks	46
Driving economy	67
Driving mode W	71, 81
E	
EBD (Electronic Brake-force Distribution)	79
ECC - Electronic Climate Control	36, 37
Electrical system	73,134
Electrically heated front seats	32
Electrically operated convertible top	44

Electrically operated front seats	50
Electrically operated sun roof	43
Electrically operated windows	38, 39
Electronic Brake Distribution (EBD)	79
Electronic Brake-force Distribution (EBD)	79
Emergency towing	75, 76
Emergency warning flashers	25
Engine	131
Engine air filter	117
Engine compartment	125
Engine oil	120, 121, 130
Engine oil - checking/changing	120
Engine oil pressure	19
Exterior courtesy lights	22
F	
Fog light - rear	19, 24
Fog lights - front	24
Front courtesy lights	54
Front fog lights	24
Front seats	50
Front seats - heated	32
Front seats - memory function	50
Fuel filter	117
Fuel gauge	18
Fuel level	19
Fuel requirements	64, 65
Fuel system	117, 132
Fuel tank cover - opening	40, 66
opening manually	105, 106
Fuses	99, 101, 102
Fuses - replacing	99
G	
Gas tank cover - opening	40, 66
opening manually	105, 106
Generator	19, 134
H	
Hand brake	32
Handling	72
Hazard warning flashers	25
Headlight wiper blades - replacing	104
Headlights	22
Heated front seats	32
Heated side-view mirrors	25
Heating	37

Heating and air conditioning	35
High beams	19
Hoisting the car	116
Homelink®	194-196
Hood	58
I	
Ignition switch	23
Immobilizer (start inhibitor)	46
Instrument illumination	24
Instruments	16, 17
J	
Jack	60, 90
Jump starting	77
K	
Keyless entry system	47
Keylock	68
Keys	46
Kick-down	70
Kickdown	71
L	
Label information	114
Lifting the car	116
Locks	46
Long load storage	57
Lubrication	119
Luggage racks - trunk-mounted	74
Lumbar support	52
M	
Maintenance service	115
Malfunction indicator lamp	19
Manual transmission	69, 133
Manually raising convertible top	106
Memory function - front seats	50
Mirrors - rear/side view	53
O	
Occupant safety	14
Octane rating	66
Odometer	18
Oil (engine)	120, 121, 130
Oil pressure warning light	20
Opening the trunk from the inside	59
P	
Paint touchup	108
Parking brake	19, 32

Parking brake reminder light	20
Parking lights	22
PCV system	117
Polishing	111
Power seats	50
Power steering fluid	122 , 130

R

Radio	
-General information	190
-SC813	138
-SC-816	151
-SC-901	167
Radio Data System - RDS	172
Reading lights	56
Rear fog light	19 , 24
Rear suspension	132
Rear window demister	25
Rear/side-view mirrors	53
Refueling	66
Remote control (central locking system)	47
Remote keyless entry system	47
Replacing bulbs	94-98
Replacing fuses	99
Reporting Safety Defects	14
Road Assistance	136
Roadholding	72
Roll Over Protection System (ROPS)	10
Roof racks (C70 Coupe)	74
Roof rails/racks	74
Rotating tires	86

S

Safety defects (reporting)	14
Seat belt maintenance	14
Seat belts	2,3,12
Automatic Locking Retractor	12
Emergency Locking Retractor	12
Seat belts - cleaning	112
Seats	50
Seats - heated	32
Securing cargo	61
Service reminder indicator	19
Servicing	116, 118
Shift lock	68
Shiftlock release (override)	105

Side Impact Protection System (SIPS)	8
Side-view mirrors - heated	25
SIPS	8
Snow chains	85
Snow tires	85
Spare tire	92
Spare tire (sedan)	60
Spark plugs	132
Speakers (rear seat) - turning on/off	39
Specifications	129
SRS	5,6,7
SRS diagnostic system	21
SRS warning light	5,19, 21
Stability and Traction Control (STC)	21, 25, 79
Start inhibitor (immobilizer)	46
Starting the engine	68
Steering wheel adjustment	34
Steering wheel lock	23
Storage compartments	42
Studded tires	85
Sun roof	25, 43
T	
Tachometer	18
Temperature gauge	18
Temporary spare tire	92
Three-way catalytic converter	127
Timing belt	117
Tire pressure	86
Tire rotation	86
Tires - changing	90
Towing	75, 76
Towing a trailer	80
Towing the car	76
Trailer towing	80
Trip computer	25, 28, 29, 30
Trip odometer	18
Trunk - opening from the inside	59
Trunk - opening/locking	59
Trunk light	60
Trunk-mounted luggage racks	74
Turn signals	19,22
U	
Uniform tire quality grading	87
Upholstery - cleaning	112

V	
Vanity mirrors	55
Vehicle Identification Number (VIN)	114
Vehicle loading	133
Volvo On Call	136
W	
Warning flashers	25
Warning lights	20, 21
Warranty	115
Washer fluid level	19
Washer fluid reservoir	123
Washing	110
Waxing	111
Wheel changing	90, 91
Wheels and tires	84
WHIPS	9
Whiplash Protection System(WHIPS)	9
Wind deflector	45
Windshield washer nozzles	123
Windshield washers/wipers	23
Windshield wiper blades - replacing	103
Winter driving	81
Winter/Wet driving mode	71, 81



**2002
VOLVO
C70 Coupe & Convertible**

Back Cover

Back Cover

Accessory Installation - Important Warning

- We strongly recommend that Volvo owners install only genuine, Volvo-approved accessories, and that accessory installations be performed only by the factory-trained technicians at your authorized Volvo retailer.
- Genuine Volvo accessories are tested to ensure compatibility with the performance, safety, and emission systems in your car. Additionally, your authorized Volvo retailer knows where accessories may and may not be safely installed in your Volvo. In all cases, please consult your authorized Volvo retailer before installing any accessory in or on your car.
- Accessories that have not been approved by Volvo may or may not be specifically tested for compatibility with your car. Additionally, an inexperienced installer may not be familiar with some of your car's systems.
- Any of your car's performance and safety systems could be adversely affected if you install accessories that Volvo has not tested, or if you allow accessories to be installed by someone unfamiliar with your car.
- Damage caused by unapproved or improperly installed accessories may not be covered by your new car warranty. See your Warranty and Service Records Information booklet for more warranty information. Volvo assumes no responsibility for death, injury, or expenses that may result from the installation of non-genuine accessories.

Driver Distraction

- Driver distraction results from driver activities that are not directly related to controlling the car in the driving environment. Your new Volvo is, or can be, equipped with many feature-rich entertainment and communication systems. These include hands-free cellular telephones, navigation systems, and multipurpose audio systems. You may also own other portable electronic devices for your own convenience. When used properly and safely, they enrich the driving experience. Improperly used, any of these could cause a distraction.
- For all of these systems, we want to provide the following warning that reflects the strong Volvo concern for your safety:
 - Never use these devices or any feature of your vehicle in a way that distracts you from the task of driving safely. Distraction can lead to a serious accident.
 - In addition to this general warning, we offer the following guidance regarding specific newer features that may be found in your vehicles:
 - Never use a hand-held cellular telephone while driving. Some jurisdictions prohibit cellular telephone use by a driver while the vehicle is moving.
 - If your car is equipped with a navigation system, set and make changes to your travel itinerary only with the vehicle parked.
 - Never program your audio system while the vehicle is moving. Program radio presets with the vehicle parked, and use your programmed presets to make radio use quicker and simpler.
 - Never use portable computers or personal digital assistants while the vehicle is moving.

A driver has a responsibility to do everything possible to ensure his or her own safety and the safety of passengers in the vehicle and others sharing the roadway. Avoiding distractions is part of that responsibility.

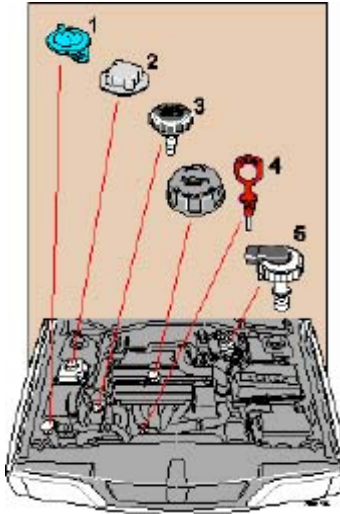

The following should be checked regularly: *

1 Washer fluid reservoir should be filled with water and solvent (wintertime: windshield washer anti-freeze). See [page 123](#).

2 Coolant level should be between the expansion tank marks. Mixture: 50% anti-freeze and 50% water. See [page 124](#).

3 Power steering - When cold, the level must not be above the COLD mark and when hot it must not be above the HOT mark. Top up if the level drops to the ADD mark with ATF fluid. See [page 122](#).

4 Engine oil level should be between the dipstick marks. The distance between the marks represents approx. 1.6 US qts (1.5 liters). See [page 120](#).

5 Brake fluid - check, without removing the cap, that the level is above the MIN mark. Use brake fluid DOT 4+. See [page 122](#).

* Engine oil should be checked each time the car is refuelled.

Octane rating, see [page 64](#).

Tire pressure, see label located on the rear edge of the right front door.

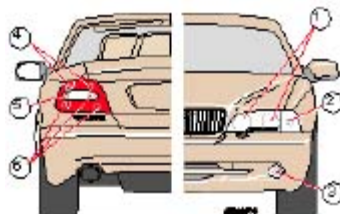

Bulbs	Power	Socket	US no.
1	55 W	-	H7
2	30/7 W	BA 15s	3357NA
3	55 W	PK 22s	H1
4	5 W	BA 15s	67

- 5 21 W BAU 15 -
- 6 21 W BA 15s 1156

See [pages 93-98](#) for more detailed information.

Volvo Car Corporation

Göteborg, Sweden



[Contents](#) | [Top of Page](#)