

**VOLVO**  
Volvo Car Corporation

TP 7116 (USA & Canada). AT 0420. Printed in Sweden, Elanders Infologistics Väst AB, Mölnlycke 2004

VOLVO  
**C70**

**VOLVO**  
for life

OWNER'S MANUAL VOLVO C70

TP 7116

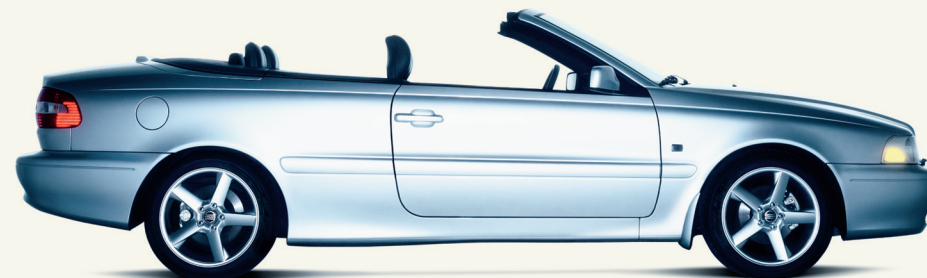

## This manual deals with the operation and care of your Volvo

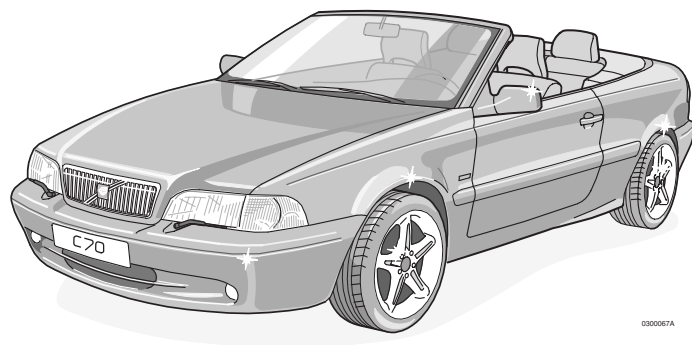

Welcome to the world-wide family of Volvo owners. We trust that you will enjoy many years of safe driving in your Volvo, an automobile designed with your safety and comfort in mind. To help ensure your satisfaction with this vehicle, we encourage you to familiarize yourself with the equipment descriptions, operating instructions and maintenance requirements/recommendations in this manual. We also urge you and your passengers to wear seat belts at all times in this (or any other) automobile. And, of course, please do not operate a vehicle if you may be affected by alcohol, medication or any impairment that could hinder your ability to drive.

Your Volvo is designed to meet all applicable safety and emission standards, as evidenced by the certification labels attached to the driver's door opening and on the left wheel housing in the engine compartment.

For further information please contact your retailer, or:

**In the USA:**

Volvo Cars of North America  
Customer Care Center  
P.O. Box 914  
Rockleigh, New Jersey 07647-0914  
1-800-458-1552  
<http://www.volvocars.us>

**In Canada:**

Volvo Cars of Canada Ltd.  
National Customer Service  
175 Gordon Baker Road  
North York, Ontario M2H 2N7  
1-800-663-8255  
<http://www.volvocanada.com>

### Accessory Installation – Important Warning

- We strongly recommend that Volvo owners install only genuine, Volvo-approved accessories, and that accessory installations be performed only by the factory-trained technicians at your authorized Volvo retailer.
- Genuine Volvo accessories are tested to ensure compatibility with the performance, safety, and emission systems in your car. Additionally, your authorized Volvo retailer knows where accessories may and may not be safely installed in your Volvo. In all cases, please consult your authorized Volvo retailer before installing any accessory in or on your car.
- Accessories that have not been approved by Volvo may or may not be specifically tested for compatibility with your car. Additionally, an inexperienced installer may not be familiar with some of your car's systems.
- Any of your car's performance and safety systems could be adversely affected if you install accessories that Volvo has not tested, or if you allow accessories to be installed by someone unfamiliar with your car.
- Damage caused by unapproved or improperly installed accessories may not be covered by your new car warranty. See your Warranty and Service Records Information booklet for more warranty information. Volvo assumes no responsibility for death, injury, or expenses that may result from the installation of non-genuine accessories.

### Driver Distraction

- Driver distraction results from driver activities that are not directly related to controlling the car in the driving environment. Your new Volvo is, or can be, equipped with many feature-rich entertainment and communication systems. These include hands-free cellular telephones, navigation systems, and multipurpose audio systems. You may also own other portable electronic devices for your own convenience. When used properly and safely, they enrich the driving experience. Improperly used, any of these could cause a distraction.
- For all of these systems, we want to provide the following warning that reflects the strong Volvo concern for your safety:
- Never use these devices or any feature of your vehicle in a way that distracts you from the task of driving safely. Distraction can lead to a serious accident.
- In addition to this general warning, we offer the following guidance regarding specific newer features that may be found in your vehicle:
- Never use a hand-held cellular telephone while driving. Some jurisdictions prohibit cellular telephone use by a driver while the vehicle is moving.
- If your car is equipped with a navigation system, set and make changes to your travel itinerary only with the vehicle parked.
- Never program your audio system while the vehicle is moving. Program radio presets with the vehicle parked, and use your programmed presets to make radio use quicker and simpler.
- Never use portable computers or personal digital assistants while the vehicle is moving.

A driver has a responsibility to do everything possible to ensure his or her own safety and the safety of passengers in the vehicle and others sharing the roadway. Avoiding distractions is part of that responsibility.

---

---

## Contents

Chapter 1 - Occupant safety	1
Chapter 2 - Instruments, switches and controls	14
Chapter 3 - Body and interior	39
Chapter 4 - Starting and driving	59
Chapter 5 - Wheels and tires	79
Chapter 6 - In case of an emergency	93
Chapter 7 - Car care	109
Chapter 8 - Volvo Service	115
Chapter 9 - Specifications	131
Chapter 10 - Audio systems	139
Index	197

## General information

### Important

Before you operate your car for the first time, please familiarize yourself with the **BREAK-IN** information on page 60. You should also be familiar with the information in the first three chapters of this manual.

Information contained in the balance of the manual is extremely useful and should be read after operating the vehicle for the first time.

The manual is structured so that it can be used for reference. For this reason, it should be kept in the car for ready access.

Do not export your Volvo to another country before investigating that country's applicable safety and exhaust emission requirements. In some cases it may be difficult or impossible to comply with these requirements. Modifications to the emission control system(s) may render your Volvo not certifiable for legal operation in the U.S., Canada and other countries.

All information, illustrations and specifications contained in this manual are based on the latest product information available at the time of publication. Please note that some vehicles may be equipped differently, depending on special legal requirements and that optional equipment described in this manual may not be available in all markets.

Volvo reserves the right to make model changes at any time, or to change specifications or design, without notice and without incurring obligation.

**CAUTION:** Certain models have reduced ground clearance due to the design of the front spoiler. Please observe caution when e.g., driving onto garage hoists, through drifted snow or when other road debris is encountered, or when parking near curbs.

**WARNING!** If your vehicle is involved in an accident, unseen damage may affect your vehicle's driveability and safety.

### Shiftlock (automatic transmission only)

When your car is parked, the gear selector is locked in the (P)ark position. To release the selector from this position, turn the ignition key to position II (or start the engine), depress the brake pedal, press the button on the front side of the gear selector and move the selector from (P)ark.

If it is necessary to manually override the shiftlock system:

- Turn the starting (ignition) key to position I
- Press firmly on the "SHIFTLOCK OVERRIDE" button located to the right of the base of the gear selector
- While holding the override button down, press the button on the front of the gear selector
- Move the selector from the (P)ark position.

### Keylock (automatic transmission only)

When you switch off the ignition, the gear selector must be in the (P)ark position before the starting (ignition) key can be removed from the ignition switch.

### Clutch interlock (manual transmission only)

The clutch must be fully depressed before you can start your car. If the clutch is not depressed, it will not be possible to start the engine.

### Anti-lock Brake System (ABS)

The ABS system in your car performs a self-diagnostic test when the vehicle first reaches the speed of approximately 12 mph (20 km/h). The brake pedal will pulsate several times and a sound may be audible from the ABS control module. This is normal.

### Fuel tank cover

The fuel tank cover is locked and must be popped open using the control on the driver's door (see illustration on page 14).

© 2004 Volvo Cars of North America, LLC.



---

---

## Volvo and the environment

Volvo is committed to the well being of our customers. As a natural part of this commitment, we care about the environment in which we all live. Caring for the environment means an everyday involvement in reducing our environmental impact.

Volvo's environmental activities are based on a holistic view, which means we consider the overall environmental impact of a product throughout its complete life cycle. In this context, design, production, product use, and recycling are all important considerations.

In production, Volvo has partly or completely phased out several chemicals including freons, lead chromates, naphthanates, asbestos, mercury and cadmium; and reduced the amount of chemicals used in our plants 50% since 1991.

In use, Volvo was the first in the world to introduce into production a three-way catalytic converter with a Lambda sond, now called oxygen sensor, in 1976. The current version of this highly efficient system reduces emissions of harmful substances (CO, HC, NOx) from the exhaust pipe by approximately 95% and the search to eliminate the remaining emissions continues. Volvo is the only automobile manufacturer to offer CFC-free retrofit kits for the air conditioning system for all models as far back as the M/Y 1975 240. Advanced electronic engine controls, refined purification systems and cleaner fuels are bringing us closer to our goal.

After Volvo cars and parts have fulfilled their use, recycling is the next critical step in completing the life cycle. The metal content is about 75% of the total weight of a car, which makes the car among the most recycled industrial products. In order to have efficient and well controlled recycling, many Volvo variants have printed dismantling manuals, indicating the weight and material of individual components. For Volvo, all homogeneous plastic parts weighing more than 1.7 oz. (50 grams) are marked with international symbols that indicate how the component is to be sorted for recycling.

In addition to continuous environmental refinement of conventional gasoline-powered internal combustion engines, Volvo is actively looking at advanced technology alternative-fuel vehicles.

When you drive a Volvo, you become our partner in the work to lessen the car's impact on the environment.

To reduce your vehicle's environmental impact, you can:

- Maintain proper air pressure in your tires. Tests have shown decreased fuel economy with improperly inflated tires.
- Follow the recommended maintenance schedule in your Warranty and Service Records Information booklet.
- Drive at a constant speed.
- See an authorized Volvo retailer as soon as possible for inspection if the check engine (malfunction indicator) lamp illuminates, or stays on after the vehicle has started
- Properly dispose of any vehicle related waste such as used motor oil, used batteries, brake pads, etc.
- When cleaning your car, use Volvo's own car care products, all of which have systematically been adapted to the environment.

### **CALIFORNIA Proposition 65 Warning**

**WARNING!** Engine exhaust, some of its constituents, and certain vehicle components contain or emit chemicals known to the state of California to cause cancer, and birth defects or other reproductive harm. In addition, certain fluids contained in vehicles and certain products of component wear contain or emit chemicals known to the State of California to cause cancer, and birth defects or other reproductive harm.

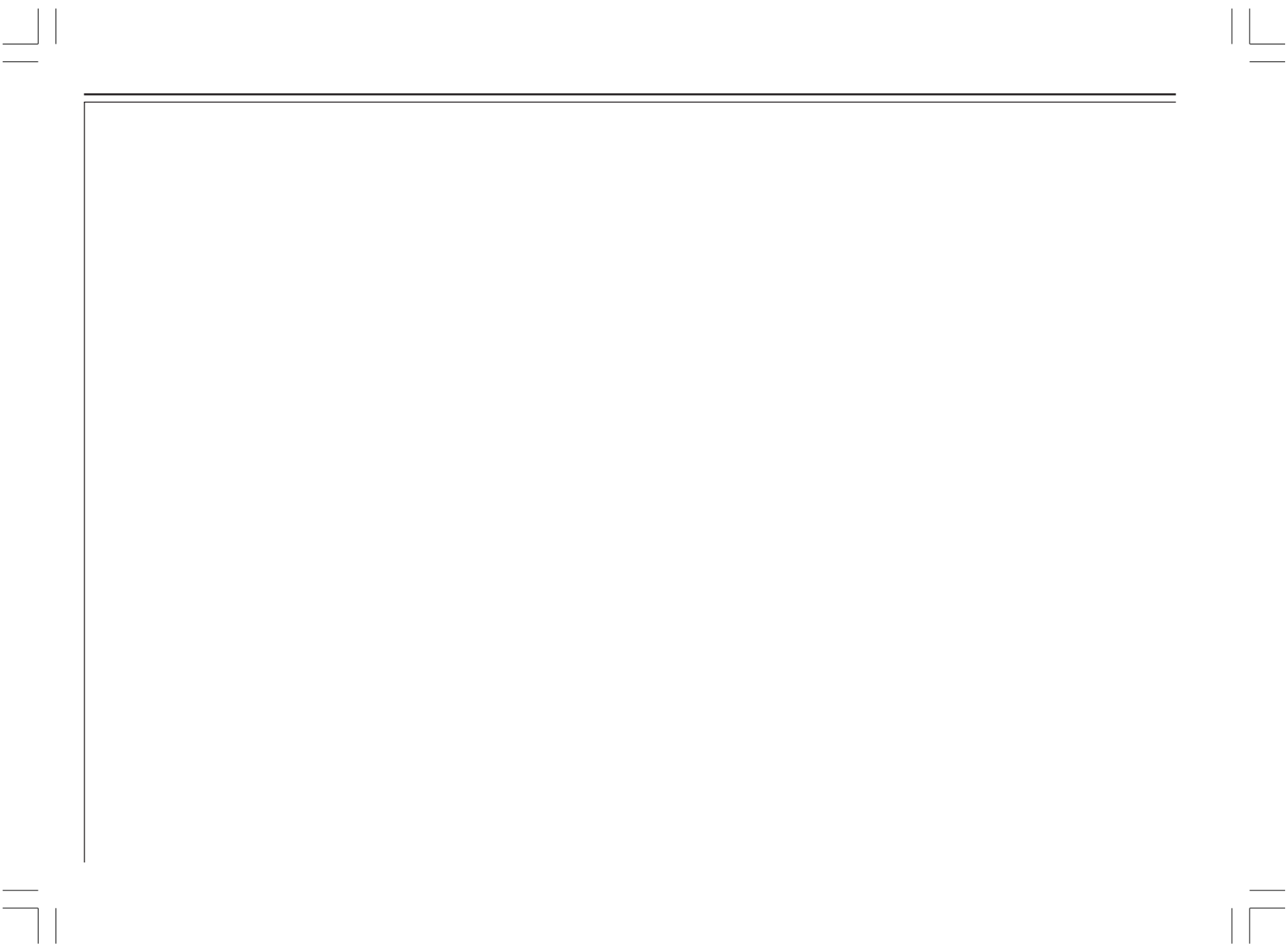

**Occupant safety**

Not wearing a seat belt is like believing "It'll never happen to me!". Volvo, the inventor of the three-point seat belt, urges you and all adult occupants of your car to wear seat belts and ensure that children are properly restrained, using an infant, car or booster seat determined by age, weight and height. Volvo also believes no child should sit in the front seat of a car.

Fact: In every state and province, some type of child-restraint legislation has been passed. Additionally, most states and provinces have already made it mandatory for occupants of a car to use seat belts.

So, urging you to "buckle up" is not just our recommendation - legislation in your state or province may mandate seat belt usage. The few seconds it takes to buckle up may one day allow you to say, "It's a good thing I was wearing my seat belt".

Seat belts	2
Volvo SRS	4
Side Impact Protection System - (SIPS) air bag	8
WHIPS	9
Roll Over Protection System (ROPS)	10
Child safety	11
Occupant safety	13
Reporting Safety Defects	13



## Seat belts

### Seat belts

Always fasten the seat belts before you drive or ride.

Two lights above the rear view mirror will be illuminated for 4-8 seconds after the starting (ignition) key is turned to the driving position. A chime will sound at the same time if the driver has not fastened his seat belt. The rear seats are provided with self-retracting inertia reel belts. The front seats are provided with single roller belts with tensioners.

#### To buckle:

Pull the belt out far enough to insert the latch plate into the receptacle (buckle for rear seats) until a distinct snapping sound is heard. The seat belt retractor is normally "unlocked" and you can move freely, provided that the shoulder belt is not pulled out too far.

The retractor will lock up as follows:

- if the belt is pulled out rapidly
- during braking and acceleration
- if the vehicle is leaning excessively
- when driving in turns

For the seat belt to provide maximum protection in the event of an accident, it must be worn correctly. When wearing the seat belt remember:

- The belt should not be twisted or turned.
- The lap belt must be positioned low on the hips (not pressing against the abdomen).

The seat belts are equipped with tensioners that reduce slack in the seat belts. These tensioners are triggered in situations where the

*Adjusting the shoulder belt*

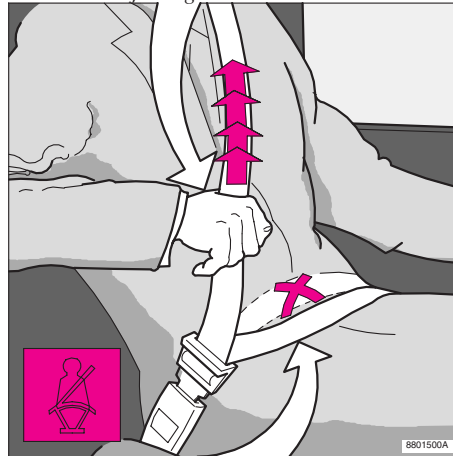

*Lap portion of the seat belt should sit low*

airbags deploy.

The front seat belts also include a tension reducing device which, in the event of a collision, limits the peak forces exerted by the seat belt on the occupant.

Make sure that the shoulder belt is rolled up into its retractor and that the shoulder and lap belts are taut.

Before exiting the car, check that the seat belt retracts fully after being unbuckled.

If necessary, guide the belt back into the retractor slot.

**NOTE:** Legislation in your state or province may mandate seat belt usage.

**For information on securing child seats, please refer to page 11.**

#### **WARNING!**

- The rear seat of the Volvo C70 is intended for two occupants only. Only two three-point seat belts are provided. The center position should never be used to seat a passenger.
- Any device used to induce slack into the shoulder belt portion of the three-point belt system will have a detrimental effect on the amount of protection available to you in the event of a collision. The seat back should not be tilted too far back. The shoulder belt must be taut in order to function properly.
- Do not use child safety seats or child booster cushions/backrests in the front passenger's seat. We also recommend that children who have outgrown these devices sit in the rear seat with the seat belt properly fastened.

### WARNING!

- The rear seat of the Volvo C70 is intended for two occupants only. Only two three-point seat belts are provided. The center position should never be used to seat a passenger.
- Never use a seat belt for more than one occupant.
- Never wear the shoulder portion of the belt under the arm, behind the back or otherwise out of position. Such use could cause injury in the event of an accident.
- As the seat belts lose much of their strength when exposed to violent stretching, they should be replaced after any collision, even if they appear to be undamaged.
- Never repair the belt on your own; have this work done by an authorized Volvo retailer only.
- Any device used to induce slack into the shoulder belt portion of the three-point belt system will have a detrimental effect on the amount of protection available to you in the event of a collision.
- The seat back should not be tilted too far back. The shoulder belt must be taut in order to function properly.



### During pregnancy

Pregnant women should always wear seat belts. Remember that the belt should always be positioned in such a way as to avoid any possible pressure on the abdomen. The lap portion of the belt should be located low, as shown in the above illustration.

## Volvo SRS



4800004

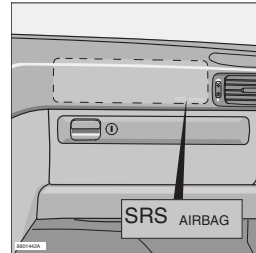

Passenger side SRS hatch

As an enhancement to the three-point seat belt system, your Volvo is equipped with a Supplemental Restraint System (SRS). The Volvo SRS consists of an airbag (2) on both the driver's and passenger's sides and seat belt tensioners in both front door pillars (4). The system is designed to supplement the protection provided by the three-point seat belt system.

The SRS system is indicated by the "SRS" embossed on the steering wheel pad and above the glove compartment, and by decals on both sun visors and on the far right side of the dash.

The airbags are folded and located in the steering wheel hub and above the glove compartment. They are designed to deploy during certain frontal or front-angular collisions, impacts, or decelerations, depending on the crash severity, angle, speed and object impacted. The airbags may also deploy in certain non-frontal collisions where rapid deceleration occurs.

The airbag system includes gas generators (1) surrounded by the airbags (2) and front seat belt tensioners for both of the front seats (4). To deploy the system, the sensor (3) activates the gas generators causing the airbags to be inflated with nitrogen gas. As the movement of the

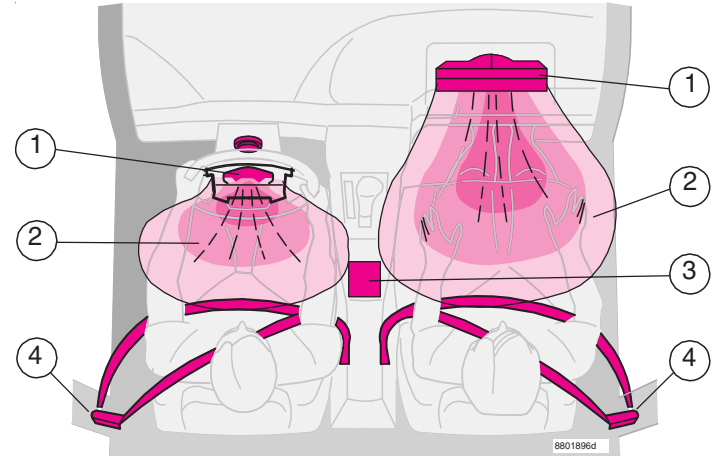

8801896d

seats' occupants compresses the airbags, some of the gas is expelled at a controlled rate to provide better cushioning. Both seat belt tensioners also deploy, minimizing any seat belt slack.

The entire process, including inflation and deflation of the airbags, takes approximately two-tenths of a second.

### WARNING!

- As its name implies, SRS is designed to be a SUPPLEMENT to - not a replacement for - the three-point belt system. For maximum protection, wear seat belts at all times. Be aware that no system can prevent all possible injuries that may occur in an accident.
- When installing any optional equipment, make sure that the SRS system is not damaged. Do not attempt to service any component of the SRS yourself. Attempting to do so may result in serious personal injury. If a problem arises, take your car to the nearest authorized Volvo retailer for inspection as soon as possible.



## Volvo SRS



*SRS texts on inside of both sun visors*



*SRS texts on outside of both sun visors*



*SRS texts on the passenger's dash*

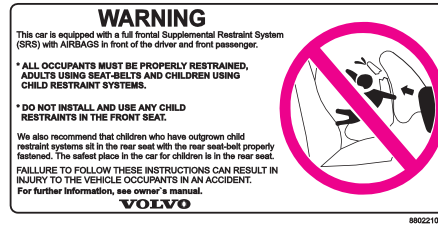

*SRS text at far right of instrument panel*

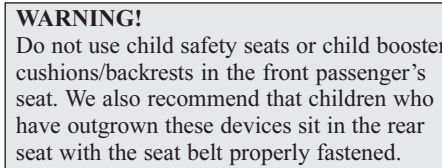

### NOTE:

- Deployment of SRS components occurs only one time during an accident. In a collision where deployment occurs, the air bags and seat belt tensioners activate. Some noise occurs and a small amount of powder is released. The release of the powder may appear as smoke-like matter. This is a normal characteristic and does not indicate fire.
- Volvo's dual-threshold air bags use special sensors that are integrated with the front seat buckles. The point at which the air bag deploys is determined by whether or not the seat belt is being used, as well as, the severity of the collision. Collisions can occur where only one of the airbags deploys.

### WARNING!

- Children must never be allowed in the front passenger seat. Volvo recommends that ALL occupants (adults and children) shorter than 4 feet 7 inches (140 cm) be seated in the back seat of any vehicle with a front passenger side airbag. See page 11 for guidelines.
- Occupants in the front passenger's seat must never sit on the edge of the seat, sit leaning toward the instrument panel or otherwise sit out of position. The occupant's back must be as upright as comfort allows and be against the seat back with the seat belt properly fastened.
- Feet must be on the floor, e.g. not on the dash, seat or out of the window.
- No objects or accessory equipment, e.g. dash covers, may be placed on, attached to or installed near the SRS hatch (the area above the glove compartment) or the area affected by airbag deployment (see illustration).
- There should be no loose articles, e.g. coffee cups, on the floor, seat or dash area.
- Never try to open the SRS cover on the steering wheel or the passenger side SRS hatch. This should only be done by an authorized Volvo service technician.
- Failure to follow these instructions can result in injury to the vehicle occupants in an accident.



**NOTE:** The information on this page does not pertain to the Side Impact Protection System airbags.

### When are the airbags deployed?

The SRS system is designed to deploy during certain frontal or front-angular collisions, impacts, or decelerations, depending on the crash severity, angle, speed and object impacted. The SRS sensor is designed to react to both the impact of the collision and the inertial forces generated by it and to determine if the intensity of the collision is sufficient for the airbags to be deployed.

#### **WARNING!**

The SRS is designed to help prevent serious injury. Deployment occurs very quickly and with considerable force. During normal deployment and depending on variables such as seating position, one may experience abrasions, bruises, swellings, or other injuries as a result of airbag(s) deployment.

- If the airbags have been deployed, we recommend the following:
- Have the car towed to an authorized Volvo retailer. Never drive with the airbags deployed.
- Have an authorized Volvo retailer replace the SRS system components.
- Use only new, Genuine Volvo Parts when replacing SRS components (airbags, seat belts, tensioners, etc.).

### When are the airbags NOT deployed?

Not all frontal collisions activate the SRS system. If the collision involves a non-rigid object (e.g., a snow drift or bush), or a rigid, fixed object at a low speed, the SRS system will not necessarily deploy. Airbags do not normally deploy in a side impact collision, in a collision from the rear or in a rollover situation. The amount of damage to the bodywork does not reliably indicate if the airbags should have deployed or not.

### Seat belts - the heart of the Volvo safety system

The heart of the Volvo safety system is the **three-point seat belt** (a Volvo invention)! In order for the SRS system to provide the protection intended, seat belts must be worn at all times by everyone in the car.

**The SRS system is a supplement to the seat belts.**

#### **WARNING!**

If your car has been subjected to flood conditions (e.g. soaked carpeting/standing water on the floor of the vehicle) or if your car has become flood-damaged in any way, do not attempt to start the vehicle or put the key in the ignition before disconnecting the battery (see below). This may cause airbag deployment which could result in personal injury. Have the car towed to an authorized Volvo retailer for repairs.

#### **Automatic transmission only:**

Before attempting to tow the car, use the following procedure to override the shiftlock system to move the gear selector to the neutral position.

- Disconnect the battery
- Wait at least one minute
- Insert the key in the ignition and turn it to position 1
- Press firmly on the shiftlock override button (located near the base of the gear selector).
- While holding the override button down, move the gear selector from the park position.

#### **WARNING!**

Never drive with the airbags deployed. The fact that they hang out can impair the steering of your car. Other safety systems can also be damaged. The smoke and dust formed when the airbags are deployed can cause skin and eye irritation in the event of prolonged exposure.

## Volvo Side Impact Protection System (SIPS) airbag

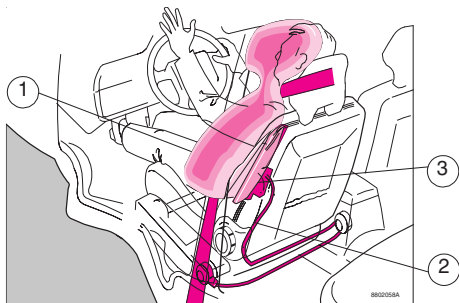

### SIPS airbag

As an enhancement to the structural Side Impact Protection System built into your car, the car is also equipped with Side Impact Protection System (SIPS) airbags. The SIPS airbag system consists of airbag modules built into the sides of both front seat backrests (1), cables (2) from these modules to the electronic sensor units (3).

The SIPS airbag system is designed to help increase occupant protection in the event of certain side impact collisions. The SIPS airbags are designed to deploy only during certain side-impact collisions, depending on the crash severity, angle, speed and point of impact. The airbags are not designed to deploy in all side impact situations.

**NOTE:** SIPS airbag deployment (one airbag) occurs only on the side of the vehicle affected by the impact.

### WARNING!

- The SIPS airbag system is a supplement to the Side Impact Protection System and the three-point seat belt system. It is not designed to deploy during collisions from the front or rear of the car or in rollover situations.
- The use of seat covers on the front seats may impede SIPS airbag deployment.
- No objects, accessory equipment or stickers may be placed on, attached to or installed near the SIPS airbag system or in the area affected by SIPS airbag deployment (see illustration to the right above).
- Never try to open or repair any components of the SIPS airbag system. This should only be done by an authorized Volvo service technician.
- For best protection from the SIPS airbag system, both front seat occupants should sit in an upright position with the seat belt properly fastened.

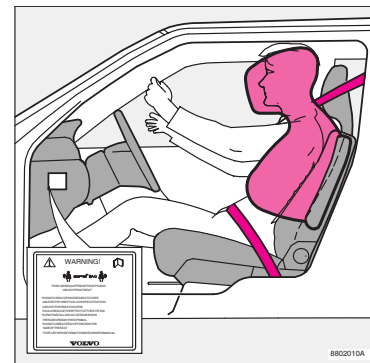

*SIPS airbag decal*

### WARNING!

- Never drive with the airbags deployed. The fact that they hang out can impair the steering of your car. Other safety systems can also be damaged. The smoke and dust formed when the airbags are deployed can cause skin and eye irritation in the event of prolonged exposure.
- If your car has been subjected to flood conditions (e.g. soaked carpeting/standing water on the floor of the vehicle) or if your car has become flood-damaged in any way, do not attempt to start the vehicle or put the key in the ignition before disconnecting the battery. This may cause airbag deployment which could result in personal injury. Have the car towed to an authorized Volvo retailer for repairs.

## Whiplash Protection System (WHIPS)

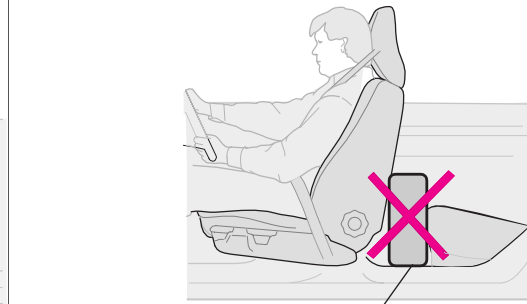
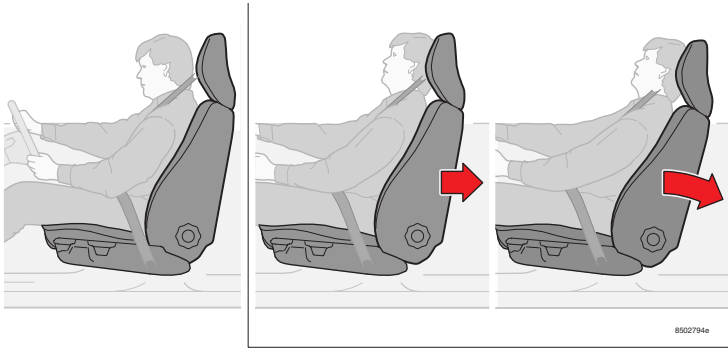

*Do not wedge boxes, suitcases, etc. behind front seats*

### Whiplash Protection System (WHIPS) - front seats only

The WHIPS system consists of specially designed hinges and brackets on the front seat backrests and head restraints designed to help absorb some of the energy generated in a collision from the rear (“rear-ended”).

In the event of a collision of this type, the hinges and brackets of the front seat backrests are designed to change position slightly to allow the backrest/head restraint to help support the occupant’s head before moving slightly rearward. This movement helps absorb some of the forces that could result in the whiplash effect.

#### WARNING!

- Boxes, suitcases, etc. wedged behind the front seats (see illustration above) could impede the function of the WHIPS system.
- The WHIPS system is designed to supplement the other safety systems in your car. For this system to function properly, the three-point seat belt must be worn. Please be aware that no system can prevent all possible injuries that may occur in an accident.
- If your car has been involved in a collision, the front seat backrests must be inspected by an authorized Volvo retailer even if the seats appear to be undamaged. Certain components in the WHIPS system may need to be replaced. Do not attempt to service any component in the WHIPS system yourself.
- The WHIPS system is designed to function in certain collisions from the rear, depending on the crash severity, angle and speed.
- Occupants in the front seats must never sit out of position. The occupant's back must be as upright as comfort allows and be against the seat back with the seat belt properly fastened.

## Roll Over Protection System (ROPS)

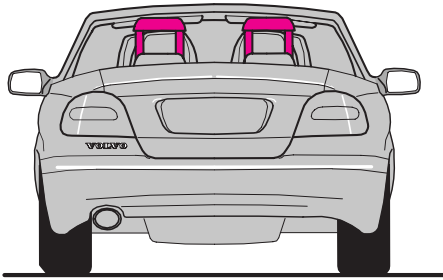

8801780A

- No objects should be placed over the roll bars behind the rear seat head restraints.
- No one should be allowed to sit on the cover over the convertible top storage compartment.

**Seats belts for all seating positions are equipped with seat belt tensioners.**

### **WARNING!**

- The rear seat of the Volvo C70 is intended for two occupants only. Only two three-point seat belts are provided. The center position should never be used to seat a passenger.
- You should never perform any maintenance or in any way attempt to repair/adjust the ROPS system yourself.

## Roll Over Protection System (ROPS)

- The ROPS system consists of two roll bars located behind the rear seat head restraints and a sensor which monitors the roll or pitch angle of the car. If the pitch angle exceeds approximately 72 degrees or the roll angle exceeds approximately 38 degrees, the sensor automatically deploys (raises) the roll bars.
- If the ROPS system has been deployed, an authorized Volvo retailer should inspect the system and make any necessary repairs/adjustments.

### Keeping child seats in place (ALR/ELR\*)

To make child seat installation easier, each seat belt (except for the driver's belt) is equipped with a locking mechanism to help keep the seat belt taut.

#### When attaching the seat belt to a child seat:

- Attach the seat belt to the child seat according to the child seat manufacturer's instructions.
- Pull the seat belt out as far as possible.
- Insert the seat belt latch plate into the buckle (lock) in the usual way.
- Release the seat belt and pull it taut around the child seat.

**A sound from the seat belt retractor will be audible at this time and is normal.**

The belt will now be locked in place.

**This function is automatically disabled when the seat belt is unlocked and the belt is fully retracted.**

### Important!

**Why Volvo believes no child should sit in the front seat of a car.**

It's quite simple really. A front air bag is a very powerful device designed, by law, to help protect an adult. Because of the size of the air bag and its speed of inflation, a child should never be placed in the front seat, even if he or she is properly belted or strapped into a child

\* Automatic Locking Retractor/Emergency Locking Retractor

safety seat. Volvo has been an innovator in safety for over fifty years, and we'll continue to do our part. But we need your help. Please remember to put your children in the back seat, and buckle them up.

#### Volvo has some very specific recommendations:

- Always wear your seat belt.
- Air bags are a SUPPLEMENTAL safety device which when used in conjunction with a three-point seat belt can help reduce serious injuries during certain types of severe accidents. Volvo recommends that you do not disconnect the air bag system in your vehicle.
- Volvo strongly recommends that ALL children sit in the rear seat of any vehicle and that they be properly restrained.
- A child should NEVER sit in the front passenger seat of any vehicle equipped with a front passenger side airbag.
- Volvo recommends that ALL occupants (adults and children) shorter than four feet seven inches (140 cm) be seated in the back seat of any vehicle with a front passenger side airbag.

#### Drive safely!

### ISOFIX/LATCH anchors

Lower anchors for ISOFIX-equipped child seats are located in the rear seats, hidden below the backrest cushions. Symbols on the seat back upholstery mark the anchor positions as shown. A plastic guide, shown above right,

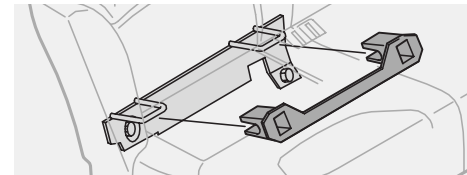
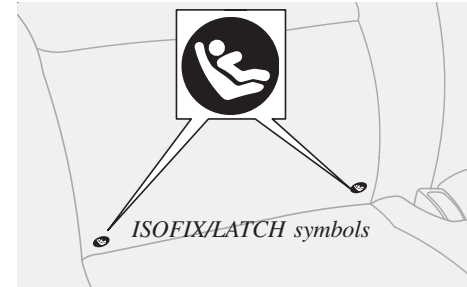

*ISOFIX/LATCH guide*

is also provided to help you mark the anchor locations.

To install the guide, kneel on the seat cushion. Locate the anchors by feel. Position the guide and press in place. To remove the guide when not in use, grasp it at both ends and slide it out.

**NOTE:** Remove the ISOFIX guide if you do not plan to use it for an extended period.

Always follow your child seat manufacturer's installation instructions, and use ISOFIX lower anchors whenever possible.

## Child safety

### Child safety

Volvo recommends the proper use of restraint systems for all occupants including children. Remember that, regardless of age and size, a child should always be properly restrained in a car.

Your car is also equipped with ISOFIX attachments, which make it more convenient to install child seats (see the previous page).

Restraint systems for children are designed to be secured in the vehicle by lap belts or the lap portion of a lap-shoulder belt. Such child restraint systems can help protect children in cars in the event of an accident only if they are used properly. However, children could be endangered in a crash if the child restraints are not properly secured in the vehicle. Failure to follow the installation instructions for your child restraint can result in your child striking the vehicle's interior in a sudden stop.

Holding a child in your arms is NOT a suitable substitute for a child restraint system. In an accident, a child held in a person's arms can be crushed between the vehicle's interior and an unrestrained person. The child could also be injured by striking the interior, or by being ejected from the vehicle during a sudden maneuver or impact. The same can also happen if the infant or child rides unrestrained on the seat. Other occupants should also be properly restrained to help reduce the chance of injuring or increasing the injury of a child.

All states and provinces have legislation governing how and where children should be carried in a car. Find out the regulations existing in your state or province. Recent accident statistics have shown that children are safer in rear seating positions than front seating positions when properly restrained. A child restraint system can help protect a child in a vehicle. Here's what to look for when selecting a child restraint system:

- It should have a label certifying that it meets applicable Federal Motor Vehicle Safety Standards (FMVSS 213) - or in Canada, CMVSS 213.
- Make sure the child restraint system is approved for the child's height, weight and development - the label required by the standard or regulation, or instructions for infant restraints, typically provide this information.
- **In using any child restraint system, we urge you to look carefully over the instructions that are provided with the restraint. Be sure you understand them and can use the device properly and safely in this vehicle. A misused child restraint system can result in increased injuries for both the infant or child and other occupants in the vehicle.**

When a child has outgrown the child safety seat, you should use the rear seat with the standard seat belt fastened. The best way to help protect the child here is to place the child on an approved booster cushion so that the seat belt is properly located on the hips.

A specially designed and tested booster cushion (not available in Canada) can be obtained from your Volvo retailer for children weighing 33 - 80 lb (15 - 36 kg) and 38-54 inches (97 - 137 cm) in height.

#### **WARNING!**

Do not use child safety seats or child booster cushions/backrests in the front passenger's seat. We also recommend that children who have outgrown these devices sit in the rear seat with the seat belt properly fastened.

### Seat belt maintenance

Check periodically that the seat belts are in good condition. Use water and a mild detergent for cleaning. Check seat belt mechanism function as follows: Attach the seat belt and pull rapidly on the strap.

### Volvo Concern for Safety

Safety is the cornerstone for Volvo. Our concern dates back to 1927 when the first Volvo rolled off the production line. Three-point seat belts (a Volvo invention), safety cages, and energy-absorbing impact zones were designed into Volvo cars long before it was fashionable or required by government regulation. We will not compromise our commitment to safety. We continue to seek out new safety features and to refine those already in our cars. You can help. We would appreciate hearing your suggestions about improving automobile safety. We also want to know if you ever have a safety concern with your car.

Call us at:  
U.S.A. 1-800-458-1552  
Canada 1-800-663-8255.

### Occupant safety

How safely you drive doesn't depend on how old you are but rather on:

- How well you see.
- Your ability to concentrate.
- How quickly you make decisions under stress to avoid an accident.

The tips listed below are suggestions to help you cope with the ever changing traffic environment.

- Never drink and drive.
- If you are taking any medication, consult your physician about its potential effects on your driving abilities.
- Take a driver-retraining course
- Have your eyes checked regularly
- Keep your windshield and headlights clean.
- Replace wiper blades when they start to leave streaks.
- Take into account the traffic, road, and weather conditions, particularly with regard to stopping distance.

### Reporting Safety Defects in the U.S.

If you believe that your vehicle has a defect which could cause a crash or could cause injury or death, you should immediately inform the National Highway Traffic Safety Administration (NHTSA) in addition to notifying Volvo Cars of North America. If NHTSA receives similar complaints, it may open an investigation, and if it finds that a safety defect exists in a group of vehicles, it may order a recall and remedy campaign. However, NHTSA cannot become involved in individual

problems between you, your retailer, or Volvo Cars of North America. To contact NHTSA, you may either call the Auto Safety Hotline toll-free at 1-800-424-9393 (or 202-366-0123 in Washington, D.C. area) or write to: NHTSA, U.S. Department of Transportation, Washington D.C. 20590. You can also obtain other information about motor vehicle safety from the Hotline.

Volvo strongly recommends that if your vehicle is covered under a service campaign, safety or emission recall or similar action, it should be completed as soon as possible. Please check with your local retailer or Volvo Cars of North America, LLC if your vehicle is covered under these conditions.

#### NHTSA can be reached at:

Internet:  
<http://www.nhtsa.dot.gov>

Telephone:  
1-888-DASH-2-DOT (1-888-327-4236) (toll free)  
1-800-424-9393 (toll free)  
1-202-366-0123 (in Washington DC area)



## Instruments, switches and controls

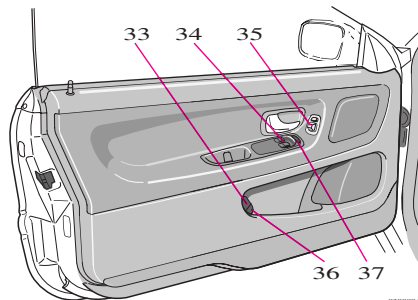
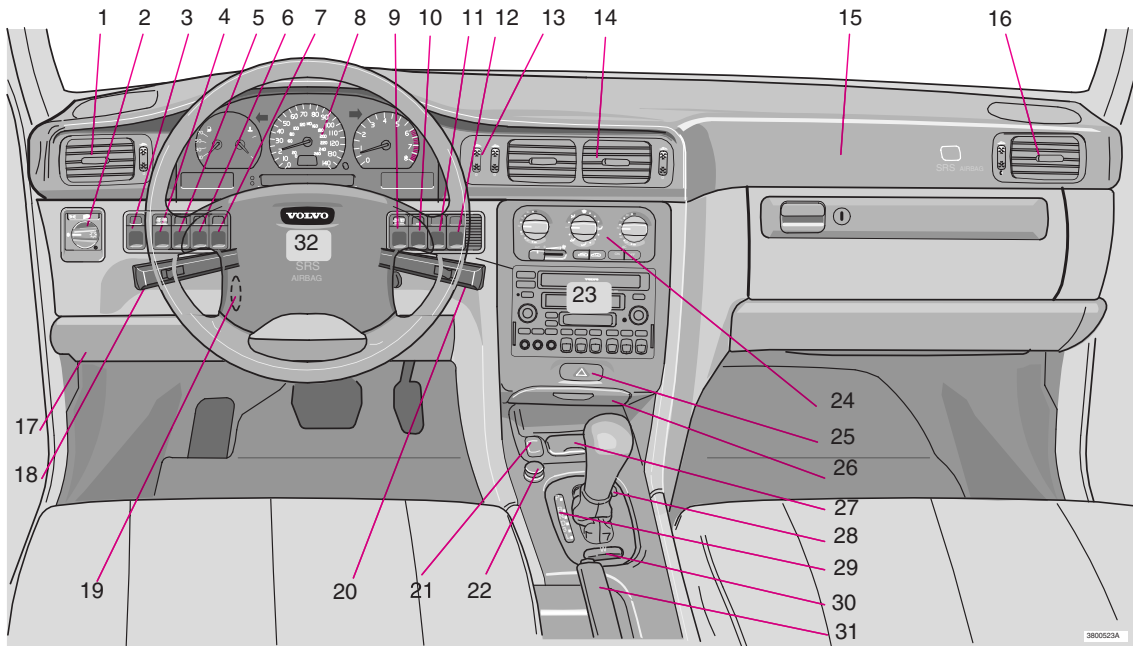



---

---

## Chapter 2 - Instruments, switches and controls

The pages in this section provide detailed descriptions of the vehicle's instruments and controls. Note that vehicles may be equipped differently, depending on special legal requirements.

	Page
1 Air vents .....	33
2 Headlights, parking lights .....	20
3 Instrument illumination .....	22
4 Rear fog light .....	22
5 Front fog lights (optional) .....	22
6 Space for additional equipment .....	22
7 Space for additional equipment .....	22
8 Instruments .....	16-17
9 Stability Control System - STC .....	23
10 Trip computer (optional) .....	26-28
11 Electrically operated convertible top .....	41
12 Rear window demister/heated door mirrors .....	23
13 Air mix .....	33
14 Air vents .....	33
15 Passenger side air bag (SRS) hatch .....	4-6
16 Air vents .....	33
17 Hood release .....	54
18 Turn signals, high/low beams, exterior courtesy lights .....	20
Cruise control .....	29
19 Adjustable steering wheel .....	32
20 Windshield wiper/washer .....	21
21 Heated front seats (optional) .....	30
22 Auxiliary socket .....	31
23 Audio systems .....	139
24 Heating and ventilation controls .....	33-35

25 Hazard warning flashers .....	23
26 Ashtray .....	31
27 Coin holder .....	42
28 Shiftlock release button (automatic transmission only) .....	106
29 Gear selector shift positions .....	65-67
30 Winter mode selector .....	67
31 Parking brake .....	30
32 Horn/SRS .....	4-6
33 Trunk open control .....	55
34 Power window controls .....	36
35 Power mirror controls .....	51
36 Fuel tank open control .....	37
37 Central locking button .....	36

**Some of the items above are available on certain models only.**

## Instruments

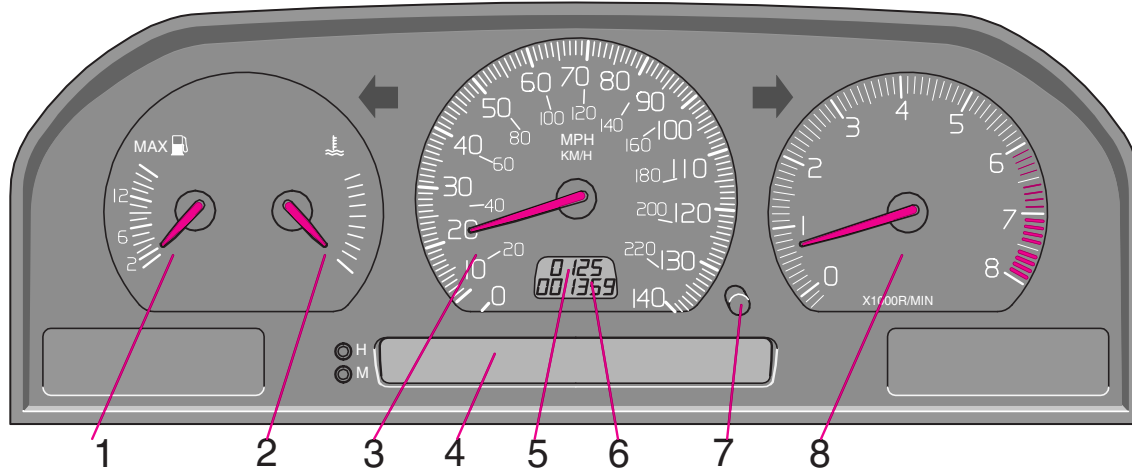

### 1 Fuel gauge

The fuel tank holds approximately 18 US gal. (68 liters). When the warning light comes on there is approximately 1.8 US gal. (8 liters) of fuel remaining. See “Refueling” for further information.

### 2 Temperature gauge

**Do not drive the car with the pointer in the red range.** The pointer should be approximately midway on the gauge face when driving. If the pointer approaches the red range repeatedly, check coolant level.

### 3 Speedometer

### 4 Clock, ambient temperature sensor, trip computer (option)

### 5 Odometer

### 6 Trip odometer

**NOTE:** Digital displays showing Clock, Trip Odometer and Odometer will go off 30 minutes after the ignition has been switched off. To view these displays again, turn the ignition key to position I.

### 7 Trip odometer reset button

Used for measuring shorter distances. The last digit indicates 1/10 mile/km.

### 8 Tachometer

Reads thousands of engine rpm. Do not drive for long with the needle in the red section. The engine has an inbuilt function preventing too high a rotation speed. When this function operates, you may discern some pulsation, which in that case is quite normal.

## Indicator and warning lights

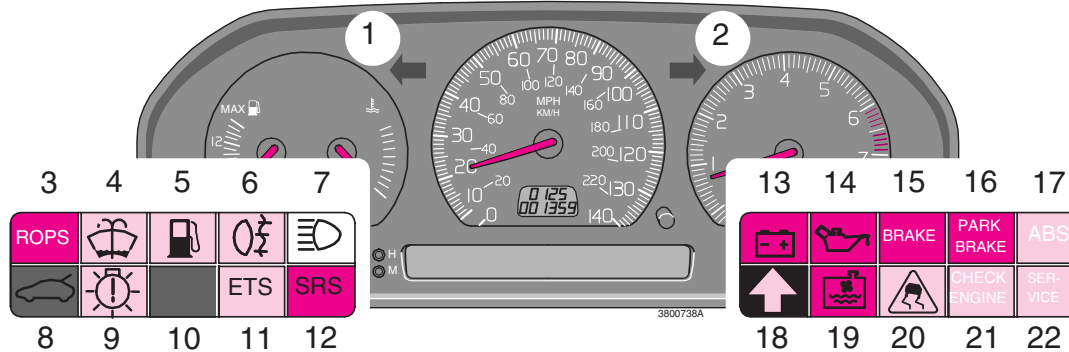

**1 Turn signal, left**

**2 Turn signal, right**

**3 Roll Over Protection system - ROPS**

**4 Low washer fluid level**

If the lamp illuminates when the engine is running, there is only about 1/2 - 1 US qt. remaining in the washer fluid reservoir.

**5 Low fuel level**

When the lamp glows, only about 1.8 US gals. (8 liters) of fuel remain. If the ignition is switched on while refuelling, the gauge may read inaccurately for up to 25 minutes.

**6 Rear fog light**

**7 High beams**

**8 Trunk open**

**9 Bulb failure warning sensor**

**10 (Not in use)**

**11 Electronic Throttle System (ETS)**

**12 SRS indicator lamp**

**13 Generator not charging**

**14 Low engine oil pressure**

**15 Brake warning light**

**16 Parking brake applied**

**17 ABS-system**

**18 Transmission mode:**

Indicates "W" if winter/wet driving mode is active, or indicates currently selected low gear.

**19 Low coolant level**

**20 Stability and Traction Control (STC) System**

**21 Malfunction indicator lamp**

(See page 18 for more information)

**22 Service reminder indicator**

## Warning lights

### The warning lights described on pages 18 and 19 should never stay on when driving

When the ignition key is turned on and before the engine starts, all of the warning lights should go on to test the function of the bulbs. Should a



### Malfunction indicator lamp

**On-Board Diagnostics II (OBDII):** As you drive, a computer called “OBDII” monitors your car’s engine, transmission, electrical and emission systems. The CHECK ENGINE light will light up if the computer senses a condition that potentially may need correcting. When this happens, please have your car checked by a Volvo retailer as soon as possible.

A CHECK ENGINE light may have many causes. Sometimes, you may not notice a change in your car’s behavior. Even so, an uncorrected condition could hurt fuel economy, emission cleanliness, and driveability. Extended driving without correcting the cause could even damage other components in your car.

**NOTE:** If the fuel filler cap is not closed tightly or if the engine is running when the car is refueled, the Malfunction Indicator Lamp may indicate a fault. However, your vehicle’s performance will not be affected. Use only Volvo original or approved fuel filler caps.

Canadian models are equipped with this warning light: 



### Oil pressure warning light

**If the light comes on while driving, stop the car and then stop the engine immediately and check the engine oil level.** See page 122. If the light stays on after restart, have the car towed to the nearest authorized Volvo retailer. After hard driving, the light may come on occasionally when the engine is idling. This is normal, provided it goes off when the engine speed is increased.



### Roll Over Protection System (ROPS)

If the warning lamp remains on after the engine has started or comes on while you are driving, the ROPS self-diagnostic system has detected a fault. The car should be driven to an authorized Volvo retailer as soon as possible for inspection.

Please refer to page 10 for more information on the ROPS system.

light not go off after the engine has started, the system indicated should be inspected. However, the parking brake reminder light will not go off until the parking brake has been fully released.



### Brake failure warning light

**If the light comes on while driving or braking, stop immediately, open the hood and check the brake fluid level in the reservoir.** See page 124 for reservoir position.

Canadian models are equipped with this warning light: 

#### **WARNING!**

If the fluid level is below the MIN mark in either section of the reservoir: **DO NOT DRIVE.** Tow the car to a Volvo retailer and have the brake system checked and any leakage repaired.



### Parking brake reminder light

This light will be on when the parking brake (hand brake) is applied. The parking brake lever is situated between the front seats.

Canadian models are equipped with this warning light: 



### STC disengaged

The indicator light (  ) in the instrument panel will be ON when you have switched the Stability and Traction Control system (STC) OFF using the button on the dashboard (see page 23). The light will also come on if there is a fault in the STC system or to indicate that the brakes have overheated. The light will go out when the brake temperature returns to normal.

The  indicator light will flash when STC is actively regulating power to the drive wheels. Normal power may be reduced at this time. This is normal as power is momentarily reduced to help keep the drive wheels from losing traction and spinning.



### Anti-lock Brake system (ABS)

If the warning lamp lights up there is a malfunction of the ABS system (the standard braking system will however function). The vehicle should be driven to a Volvo retailer for inspection.

See page 74 for additional information.

Canadian models are equipped with this warning light: 



### Coolant level sensor

If this light comes on while driving, the coolant level is low. The coolant level in the expansion tank should be checked immediately and topped up if necessary. The cooling system should be inspected by an authorized Volvo retailer.



### Mode “W” engaged

The lamp will light up when the Winter/Wet starting mode is engaged or if gears “3” or “L” are selected.

If the warning lamp begins to **flash**, this means that there is a fault in the automatic gearbox. Contact Your Volvo retailer.



### Supplemental Restraint System (SRS)

If the light comes on (or stays on after the vehicle has started), the SRS diagnostic system has detected a fault. Drive to an authorized Volvo retailer for an inspection of the system. See the SRS section for more information.



### Generator warning light

If the light comes on while the engine is running, have the charging system checked.



### Service reminder indicator

This light will come on at 7,500 mile (12,000 km) intervals, after 750 hours of driving or after 12 months, whichever occurs first. It is a reminder to the driver that the service interval has been exceeded. The light will stay on for 2 minutes after start until reset by the servicing retailer.



### Bulb failure warning light

The light will come on if any of the following bulbs are defective:

- one of the low beam headlights
- one of the tail lights
- one of the brake lights when the brake pedal is depressed.

Check the fuse and bulb. See sections “Replacing bulbs” and “fuses.”

Should the warning light come on after a defective outside bulb has been replaced, the corresponding bulb on the other side of the car should also be replaced.





### Fault in ETC (Electronic Throttle Control system)

If this lamp comes on, there is a fault in the engine control system and driveability will be affected. Switch the ignition off and then on again. If the light remains on, the system should be inspected by an authorized Volvo retailer.



## Headlights, Parking lights, Turn signals

### Headlights and parking lights

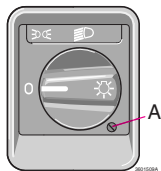
-  All lights off \*
-  Parking lights on \*
-  Headlights and parking lights are on if starting (ignition) switch is in positions I or II.



If the headlight switch is in the position  all lights will go out when the starting switch is switched off.

With the headlight switch in position  the parking lights will stay on (headlights off) with the daytime running light screw (A) in position .

The high beams can only be switched on if the headlight switch is in position .

Switch from high to low beams and vice versa by moving the turn signal switch lever on the left side of steering column towards the steering wheel.

\* See page 24 for information on Daytime running lights.

### Exterior courtesy lights

When you leave your car at night, you can make use of the exterior courtesy lighting function:

- Remove the key from the ignition switch.
- Pull the direction indicator lever towards the steering wheel (as when using the headlight flasher function).

The low beam headlights will now remain on for 30 seconds to light your way.

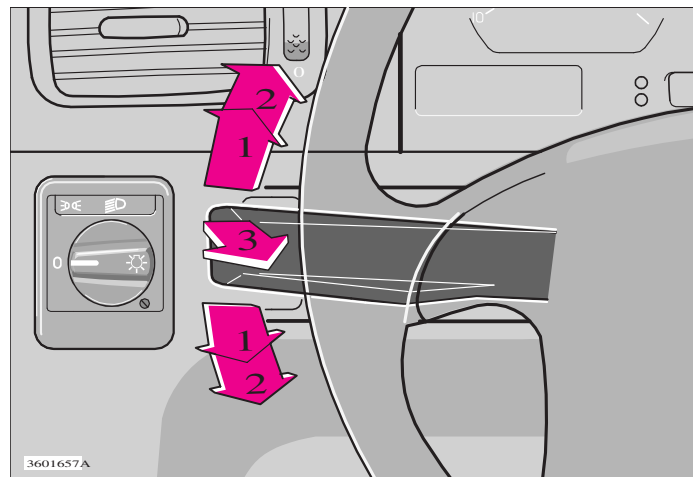

### Turn signals

- 1 Lane change position.** In maneuvers such as lane changing, the driver can flash the turn signals by moving the turn signal lever to the first stop and holding it there. The lever will return to the neutral position when released.
- 2 Signal lever engaged for normal turns.**
- 3 High beam/low beam switch (headlights on).** Move the lever towards the steering wheel and release it.  
**Headlight flasher (headlights off).** Move the lever towards the steering wheel. The headlight high beam will be on until the lever is released.

**NOTE:** A defective turn signal bulb will cause the turn signal indicator and remaining signal lights to flash more rapidly than normal.

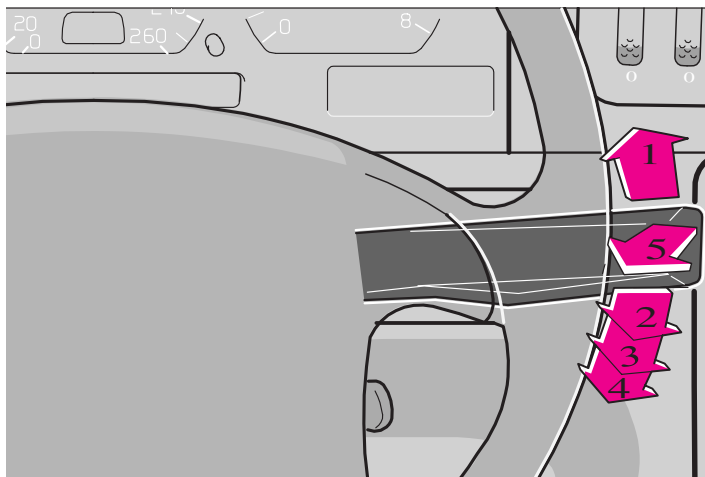

## Windshield wipers/washers

### 1 Intermittent wiper

With the switch in this position, the wipers will sweep approximately every seventh second.

### 2 “Single sweep” position:

The switch returns automatically when released.

### 3 Wipers, normal speed

### 4 Wipers, high speed

### 5 Windshield wiper/washer, headlight wiper/washer

The wipers will make 2-3 sweeps across the windshield and headlights (certain models) after the lever is released.

## Windshield wipers/washers, Ignition switch

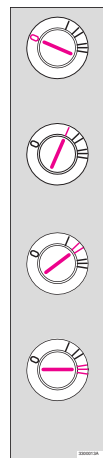

### O Locked position:

Remove the key to lock the steering wheel\*

**WARNING!** Never turn the key to position O while driving or when the car is being towed.

### I Intermediate position\*\*:

Certain accessories, radio, etc. on, daytime running lights off.

### II Drive position:

Key position when engine is running.

### III Starting position:

Release the key when the engine starts. The key returns automatically to the Drive position.

\* On cars equipped with an automatic transmission the gear selector must also be in the (P)ark position.

\*\* Please be aware that leaving the key in this position will increase battery drain.

## Starting (ignition) switch/steering wheel lock

If you find it difficult to insert the key in the ignition or to move the steering wheel, the steering wheel lock might be under tension. Turn the wheel back and forth slightly to free the ignition key.

In order to reduce car theft, make sure the steering wheel lock is engaged before leaving the car.

A chime will sound if the starting key is left in the ignition lock and the front door on the driver’s side is opened.

**WARNING!** Never switch off the ignition (turn the ignition key to position 0) or remove the key from the ignition switch while the car is in motion. This could cause the steering wheel to lock, which would make the car impossible to steer.

## Instrument illumination, Fog lights

### 1 - Instrument illumination

To increase the brightness: move the thumbwheel up.

To decrease the brightness: move the thumbwheel down.

### 2 - Rear fog light \*

The rear fog light (located in the driver's side tail light cluster) is considerably brighter than the normal tail lights and should be used only when the atmospheric conditions, such as fog, rain, snow, smoke or dust reduce the daytime or night-time visibility of other vehicles to less than 500 ft. (150 meters).

For the rear fog light to function, the low beam headlights must be switched on.

\* By design, there is one rear fog light only, located in the driver's side tail light cluster.

### 3 - Front fog lights

The front fog lights, located in the front spoiler, will only function in combination with the low beam headlights.

### 4 - Space for optional equipment

### 5 - Space for optional equipment

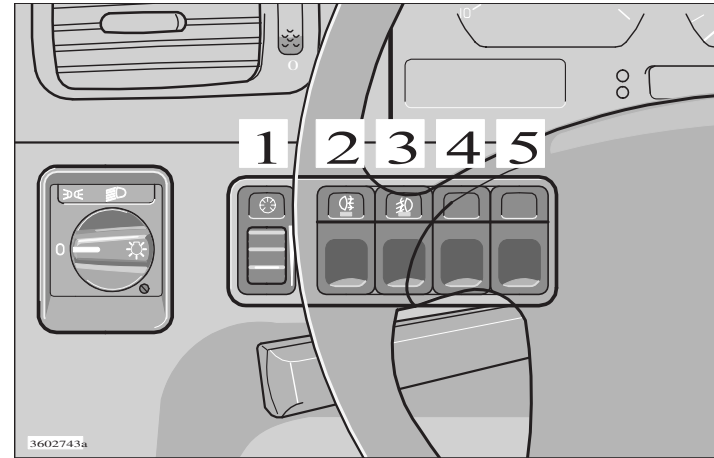



## STC, Trip computer, Hazard warning flashers, Demister

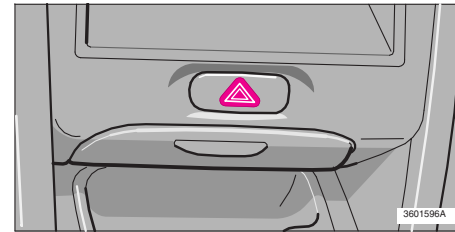
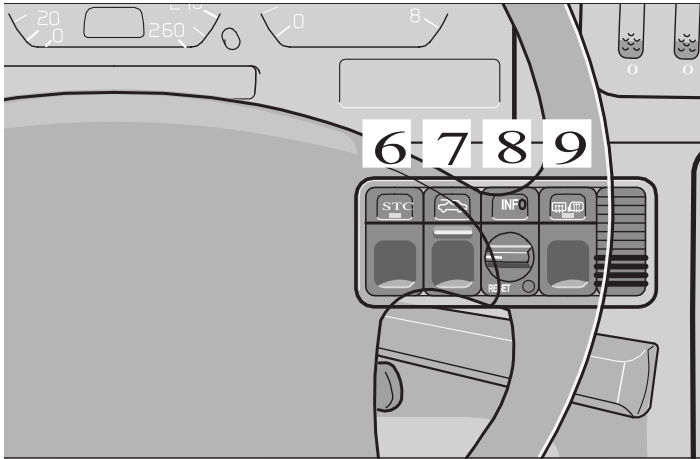

*Hazard warning flashers*

### **6 - Stability and Traction control (STC)**

See page 75 for more information on this system.

### **7 - Electrically operated convertible top**

See page 40 for operating instructions.

### **8 - Trip computer (option-accessory)**

Turn the dial to the desired function. For more information, see pages 26-28.

### **9 - Rear window demister, heated side-view mirrors**

Press the switch to start heating the rear window and side-view mirrors. The control light in the switch will illuminate.

A timer switches off the system after approximately 12 minutes. The control light will go out correspondingly.

### **Hazard warning flashers**

The four-way flasher (located above the ashtray) should be used to indicate that the vehicle has become a traffic hazard.

**NOTE:** Regulations regarding the use of the hazard warning flasher may vary from state or province.

## Daytime running lights

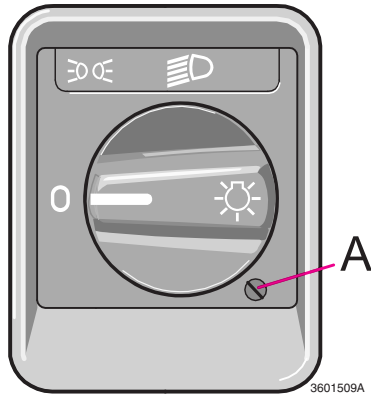

### Automatic daytime running lights

Screw A in the illustration (available on U.S. models only) is used to control the automatic daytime running lights when the headlight switch is in position 0.

The low beams, tail lights, parking lights and license plate lights will come on automatically when the ignition is switched on.

To adjust, press in the screw with a small screwdriver and turn to one of the following positions:

- ① **Automatic daytime running lights**
- ⊗ **Automatic daytime running lights**

The daytime running lights will also function when the headlight switch is in position ~~DE~~ and switch A is in this position.

- ⊙ **All lights off** (daytime running light function disabled)

**NOTE:** The daytime running light function may only be disabled (turned off) in the U.S. - Canadian law mandates the use of daytime running lights.

## Clock, Ambient temperature sensor (certain models)



### Resetting the clock

The digital clock can be reset by pressing one of the two buttons (A and B) with a pointed object such as the tip of a pen.

**h = hours**

**m = minutes**

Maintain the pressure on the buttons for more than four seconds to change the time more quickly.

**NOTE:** Digital displays showing Clock will go off 30 minutes after the ignition has been switched off. To view these displays again, turn the ignition key to position I.

### Ambient temperature sensor

This sensor indicates the temperature slightly above the road surface and represents air temperature where road icing may occur. An amber indicator light (C) in the "snowflake" symbol lights up when the temperature is in the range of 23 - 36° F (-5 - +2° C). **Please note that this light does not indicate a fault with your car.**

At low speeds or when the car is not moving, the temperature readings may be slightly higher than the actual ambient temperature due to the heat generated by the engine.

### Display alternatives

If buttons A and B are pressed down simultaneously, it is possible to shift between four different display alternatives:

Press 1st time: 12 hour clock and °F

Press 2nd time: 24 hour clock and °F

Press 3rd time: 12 hour clock and °C

Press 4th time: 24 hour clock and °C

## Trip computer (option)

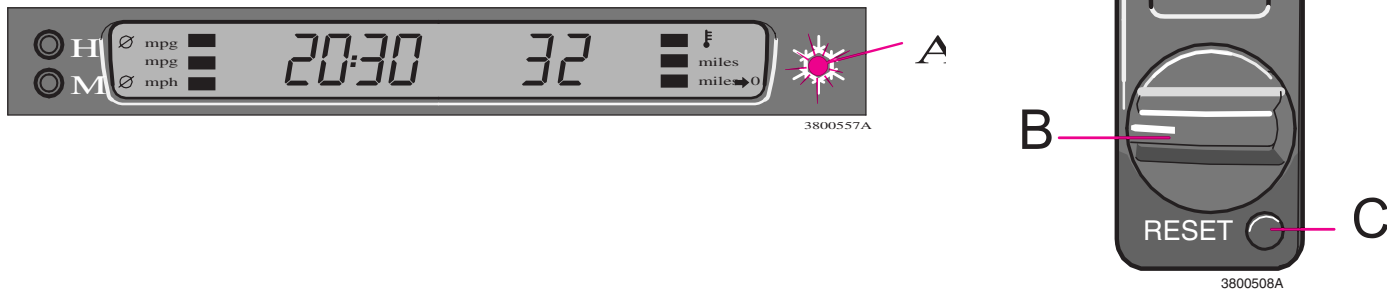

### Trip computer

The trip computer offers six functions which are presented in a single display. The cursor indicates the selected function. The trip computer's clock is shown permanently in the left-hand field. Refer to the previous page for more detailed information regarding the clock function.

The following data is monitored by the computer:

- Average speed
- Current fuel consumption
- Average fuel consumption
- Ambient temperature \*
- Tripmeter
- Driving distance on current fuel reserve

\* Warning light A in the illustration above. See page 28 for more details.

### Trip computer controls

Select one of the trip computer's six functions by using control B. The Reset button (C) is used to reset the following functions:

- Average speed
- Average fuel consumption
- Trip meter

Rotate the control to the required position and press the button for at least two seconds to reset the selected function.

**NOTE:** If pressure is maintained on the button for another three seconds, all three of the functions mentioned above will be reset.

## Trip computer (certain models)



### Average speed 0 mph (Canada: km/h)

Average speed since the function was last reset. When the ignition is switched off, the average speed is stored in memory and is used as the basis for the new figure when the engine is started again. It can be reset by pressing the reset button on the trip computer control.



### Current fuel consumption mpg (Canada: L/100 km)

Continuous information on current fuel consumption, calculated once per second. When the car is not moving, the display shows "---".



3800558A

### Average fuel consumption 0 mpg (Canada: L/100 km)

Average fuel consumption since the function was last reset. When the ignition is switched off, the average fuel consumption figure is stored in memory and remains in memory until it is reset using the button on the trip computer control.

## Trip computer (certain models)

### Ambient temperature

Shows the ambient temperature just above the road surface while driving. When the temperature is in the range 23-36° F (-5 - +2° C), the ambient temperature sensor activates an indicator light in the "snowflake" symbol to help alert the driver of possible slippery driving conditions. **Please note that this light does not indicate a fault with your car.**

At low speeds or when the car is not moving, the temperature readings may be slightly higher than the actual ambient temperature due to the heat generated by the engine.



### Tripmeter in miles (Canada: km)

Shows the distance driven since the function was last reset. This value is stored in memory until it is reset using the reset button on the trip computer control.



### Driving distance on current fuel reserve mile → 0 (Canada: km)

Shows the approximate distance which can be driven on the fuel remaining in the tank, calculated on the basis of the average fuel consumption during the last 12 miles (20 km) driven and the amount of fuel remaining in the tank at the time of the reading.

When the quantity of fuel drops to below approximately 1.8 US gals. (8 liters), a warning light in the instrument panel comes on. When the driving distance on the current fuel reserve is less than 12 miles (20 km), the display shows "—".

**NOTE:** This distance is based on an average value and can be affected by driving style, temperature, etc.



3800559A

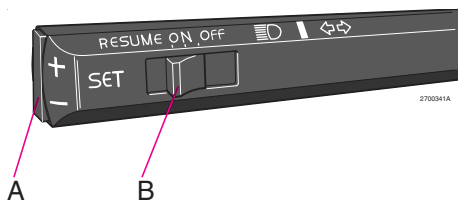

## Cruise control

The cruise control switches are located on the turn signal lever.

### To engage and set the desired speed:

1. Set switch (B) to ON.
2. Accelerate to the desired cruise speed.
3. Press the + or - area of the SET button (A) to set the desired speed.

**NOTE:** The cruise control cannot be engaged at speeds below 22 mph (35 km).

## Braking

This will automatically disengage the cruise control. The previously selected cruise speed is retained in the memory and by momentarily setting the switch to the RESUME position, that speed will be re-engaged.

If the cruise control is already engaged, the cruising speed can be increased or decreased by depressing the SET button (A) towards either + or -. One short press on the button corresponds to a speed change of approx. 1 mph (1.6 km/h). When the button is released, the vehicle will maintain the current speed.

If the actual speed falls below 70% of the set speed or if the wheels spin or lock, the cruise

control will disengage automatically.

### **NOTE:** (AUTOMATIC TRANSMISSION)

When driving up steep hills with the cruise control engaged, the transmission may shift intermittently.

## Acceleration

Momentary acceleration, such as for passing, does not interrupt cruise control operation. The previously selected speed will be maintained without having to set the switch to RESUME.

## To disengage the cruise control system:

Set switch (B) to OFF, depress the brake pedal or move the gear selector to position N.

Switching off the starting (ignition) switch will automatically disengage the cruise control system.

On cars equipped with manual transmissions, the cruise control can also be disengaged by depressing the clutch.

### **WARNING!**

The cruise control should not be used in heavy traffic or when driving on wet or slippery roads. Do not use or resume cruise control in reverse gear.

**NOTE:** When the ignition is switched off, any information stored in the cruise control memory is erased.

## Heated front seats (option), Parking brake

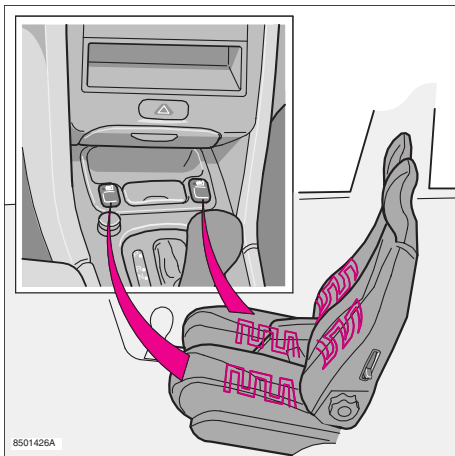

### Heated front seats

The heated front seats can be switched on and off as required. When switched on, the system senses the ambient temperature and regulates the level of heat applied. When the optimum temperature is reached, the heating switches off automatically. While driving, the seat heating for the passenger seat should be switched off when the seat is not occupied.

NOTE: The passenger seat heater will not function if the seat is not occupied.

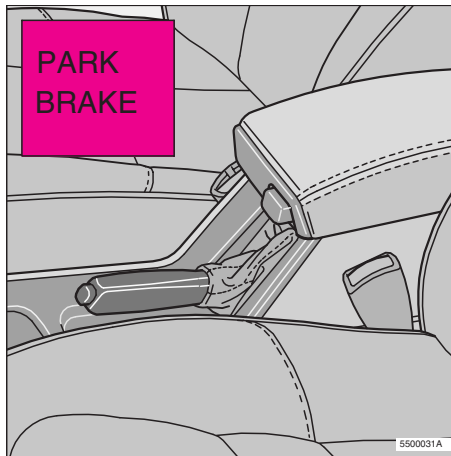

*Parking brake lever*

### Parking brake (hand brake)

The lever is situated between the front seats. The brake is applied to the rear wheels.

#### **WARNING!**

Always use the parking brake (hand brake) when parking. On hills, also turn the front wheels toward the curb.

The indicator light in the instrument panel will light up even if the parking brake is only applied slightly. Be sure to pull the lever up sufficiently.



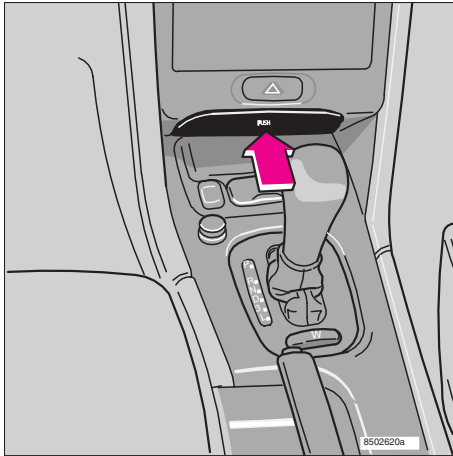

*Ashtray*

### Front ashtray (option)

To **open** the front ashtray, press lightly on the panel.

To **empty** the front ashtray:

- Put the gear selector (aut. transmission) in position L. To release the gear selector from the (P)ark position, the ignition key must be in position II and the brake pedal must be depressed.
- Grasp the front edge of the ashtray and pull it straight out.

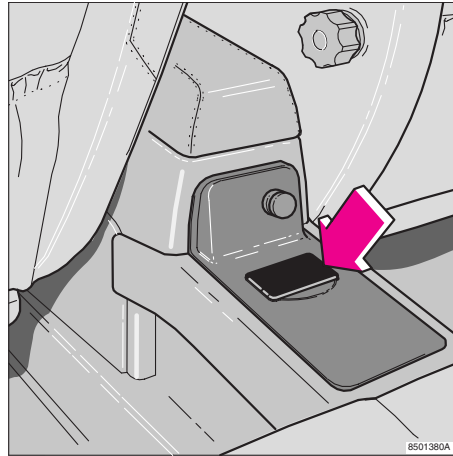

*Rear seat auxiliary\* socket and ashtray*

### Rear ashtray (option)

To **open** the rear ashtray, pull it straight out.

To **empty** the rear ashtray, pull it out, lift up the rear edge and remove.

### Auxiliary socket

This 12 volt socket can be used to plug in certain accessories, such as cellular telephones. A cigarette lighter, available as an accessory from your Volvo retailer, may also be used in this socket.

The ignition key must be in position I or higher for the socket to function.

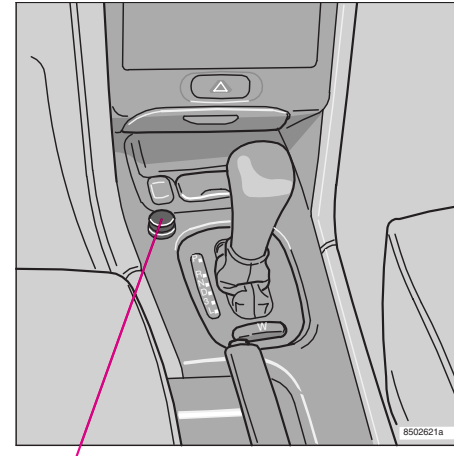

*Auxiliary socket\**

**NOTE:** The "OBD II" terminal, a connector for diagnostic equipment, is located under the cover of the storage compartment between the front seats. This terminal is intended for use by authorized service technicians only.

\* The auxiliary sockets can also be used as cigarette lighters. Please consult your Volvo retailer.

The key must be in position I (or higher) for the auxiliary socket to function.

## Steering wheel adjustment

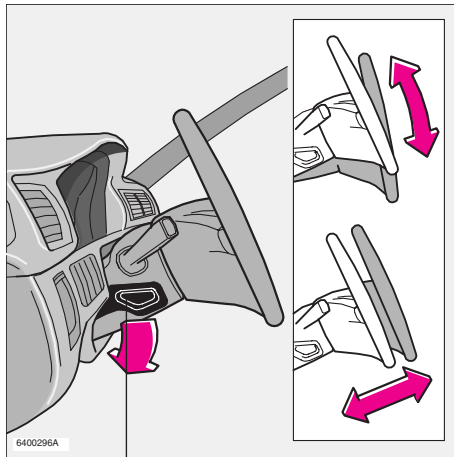

*Pull down....*

### Steering wheel adjustment

Both the height and the reach of the steering wheel can be adjusted to a comfortable position for the driver. Pull down the lever on the left of the steering column. Adjust the steering wheel to a suitable position and press the lever back into place to lock the steering wheel in the new position. Check that the steering wheel is locked in the new position.

#### **WARNING!**

Never adjust the steering wheel while driving.

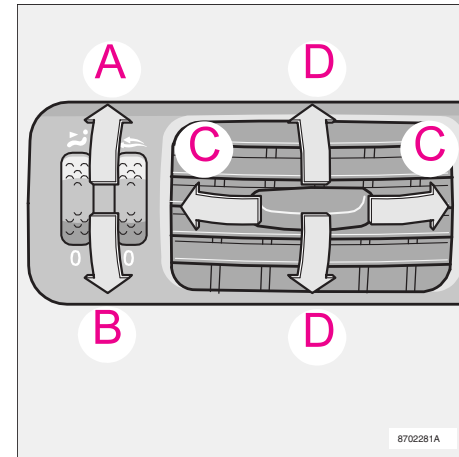
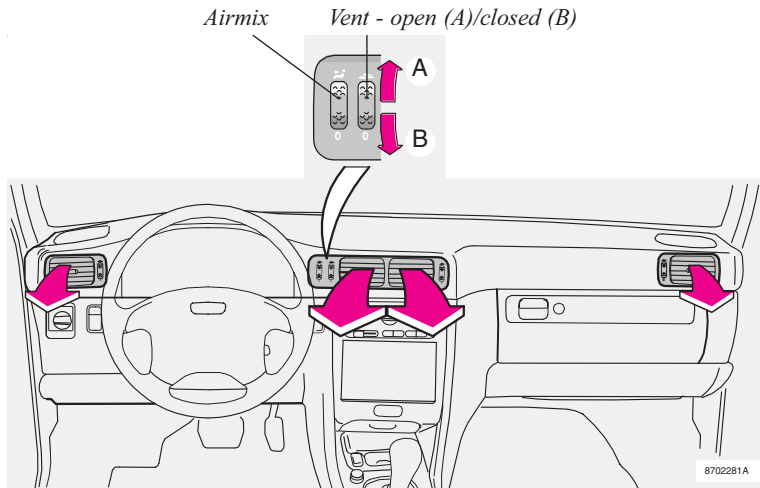

### Heating and air conditioning

Your Volvo is equipped with a heating system combined with air conditioning. Depending on which function you select, warm or cool/cold air is distributed to the different parts of the passenger compartment. A slight amount of condensation may be emitted from the air vents when the air conditioning is initially switched on. This can occur when both humidity and ambient temperature are high and is normal.

### Air mix (fresh air)

The center panel vents have an air mix function which allows fresh air to enter the passenger compartment when the vents are open (position B). This function is designed to allow you to direct cool air toward your face while directing warmer air to the rest of the passenger compartment.

**To warm/cool the compartment as quickly as possible, the air mix control should be in the closed position.**

### Air vents (dash)

- A Open
- B Closed
- C Directing air flow horizontally
- D Directing air flow vertically

### Refrigerant

Volvo cares about the environment. The air conditioning system in your car contains a CFC-free refrigerant - R134a. This substance will not deplete the ozone layer. The system contains 1.63 lbs (0.75 kg) R134a and uses ZXL 100PG (type PAG) oil.

**NOTE:** All maintenance on the climate control systems should be carried out by an authorized Volvo service technician only.

## Heating, ventilation and air conditioning (Electronic Climate Control)

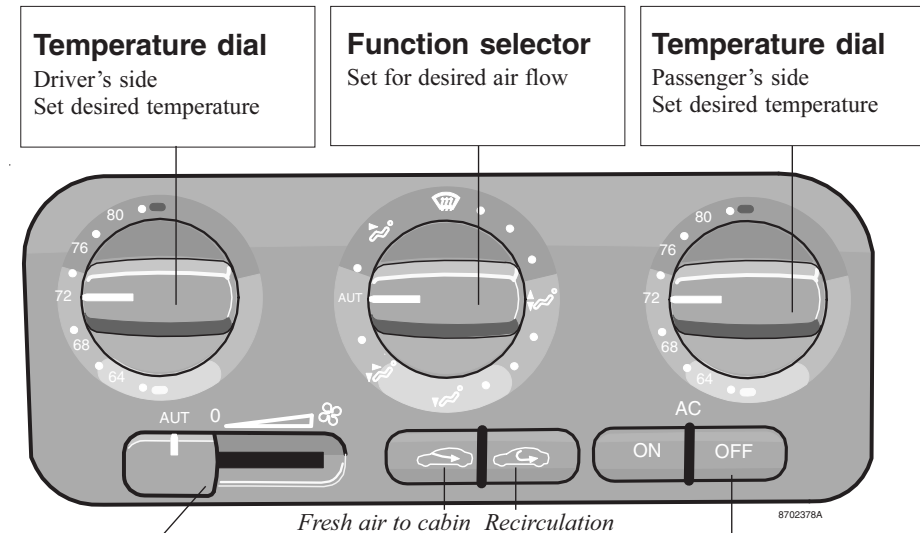

### Temperature dial

Driver's side  
Set desired temperature

### Function selector

Set for desired air flow

### Temperature dial

Passenger's side  
Set desired temperature

### BLOWER

AUT=Blower speed automatically regulated.  
0=OFF  
Move the knob to the right to increase blower speed.

### RECIRCULATION

Air in the cabin recirculates (no fresh air enters the car). The amber light in the recirculation button is ON when the function is engaged. This function should not be used for more than 15 minutes\*. The green light in the fresh air button indicates that outside air can enter the cabin.

### AC ON/OFF

The lights in the buttons indicate if the A/C is off or on \*\*.

\*\* When the function selector is in the defrost setting, the A/C system is always ON and the blower will function at its highest speed if it is in the AUT position.

**AUT** Air distribution automatically regulated

 Air through panel vents

 Defrost. Air to windshield and side windows. Recirculation will not function regardless of button setting.

 Air to floor, windshield and side windows.

 Air through floor vents.

 Bi-level. Air through floor and panel vents.

\* **To activate the recirculation timer function**, press the recirculation button for more than 3 seconds. The green and amber button lights will flash 5 times to show that the timer mode is being activated. In this mode, each time the recirculation button is pressed, the climate control system will recirculate cabin air for 5-12 minutes, depending on outside air temperature. Pressing the fresh air button at any time during this period will allow fresh air into the cabin. If the car is switched off while timer mode is active, this mode will still be active when the car is restarted. **To deactivate the recirculation timer function**, press the recirculation button again for more than 3 seconds (the button lights will glow steadily for 5 seconds) to return the button to its original function (i.e. recirculation will remain on until the fresh air button is pressed).

## Heating, ventilation and air conditioning (Electronic Climate Control)

### Automatic setting

Max heating

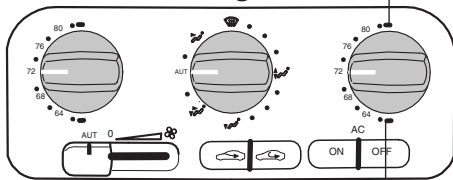

Max cooling

Set the function selector and blower control to AUT and select the desired temperature. If the driver's side temperature selector is set to either the max heating or max cooling position, the blower will run at its maximum speed.

### Optimum defrosting

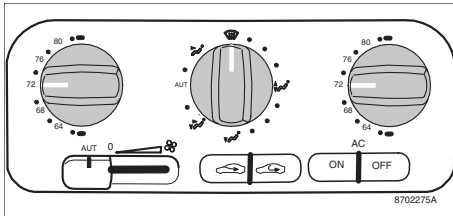

Set the function selector to  and move the blower control to the position AUT (as far to the left as possible). The A/C system will be on at this time even if the AC OFF button is depressed and the blower will run at its maximum speed. When the windows have cleared, set the function selector in the AUT position.

### Additional information

- The air conditioning system will function best if it is always left on.
- Always keep the air intake grille at the base of the windshield under the rear edge of the hood free of snow.
- Water under the vehicle in hot weather can be the result of condensation from the air conditioning system and is quite normal.
- The air conditioning is disengaged when the blower is set at 0 and the speed of the vehicle is less than 20 mph (30 km/h).
- The air conditioning system functions only at temperatures above 32° F (0° C).
- **RECIRCULATION:** When Recirculation is activated, very little air is drawn into the passenger compartment from the outside. Use this function if the outside air is contaminated with exhaust gases, smoke, etc or to heat/cool the car quickly. *If your windows begin to fog or mist, check that the recirculation function is NOT engaged.*

**NOTE:** To help maintain stable passenger compartment temperature when driving with the convertible top down, or with the windows open, adjust blower speed and the temperature manually.

**The air conditioning switches off automatically when the convertible top is down. The temperature must then be adjusted manually.**

- If the panel vents are open, a certain amount of air will always flow through, regardless of the position the function dial is in. To increase the flow of air to either the floor or the windows, close the panel vents and open

the outer vents.

- The panel vents may emit some condensation when the air conditioning is initially switched on and is quite normal. This may occur if the ambient temperature and humidity are high.
- The sunlight sensor (located at the top center of the dashboard) should not be covered in any way as this could cause incorrect information to be sent to the ECC system.
- The air conditioning is momentarily disengaged during full-throttle acceleration.

### Difficult weather conditions

When driving in very humid conditions, heavy rain, sleet, etc., it may be better to use the manual rather than the automatic setting to defrost the windows. Set the mode selector to "Defrost"  or "Defrost/floor" and the fan speed to mid-range. Also shut the center air vents.

### Faults in the ECC system

The RECIRCULATION ON and AC OFF lights will flash for approximately 20 seconds if a fault is detected in the ECC system.

If this flashing recurs the next time the system is switched on, the climate control unit should be checked by an authorized Volvo retailer.

## Electrically operated windows, Central locking button

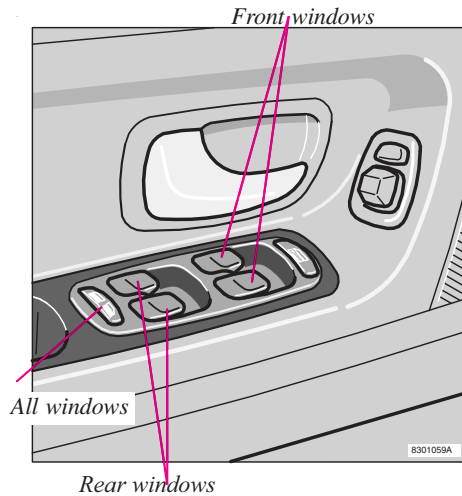

pressing the button again. If the button is held down, the window will be lowered until the button is released.

**NOTE:** When the convertible top is raised/lowered, all windows are automatically lowered slightly. When the top is completely raised/lowered, the windows will return to their original position.

### "All Windows" button

This button can be used to raise/lower all side windows at the same time.

**To lower:** press the right side of the button.

**To raise:** press the left side of the button.

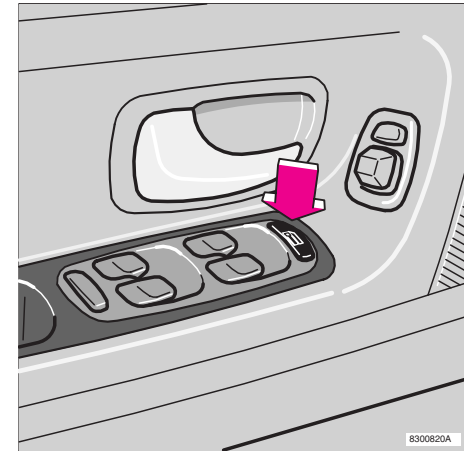

Central locking button

### Electrically operated windows

The electrically operated windows are controlled by buttons on the driver's door armrest. The starting (ignition) switch must be ON (intermediate position I) for the electrically operated windows to function.

**To lower:** press down on the front edge of the button.

**To raise:** pull up on the front edge of the button.

**Auto-down function** - driver's window/"All Windows" button: The window(s) can be opened automatically by pressing the front part of the button quickly and **releasing** it immediately. The window can be stopped by

### Central locking button

Press the switch to lock/unlock the doors and the trunk.

**Lock:** press the left section of the switch.

**Unlock:** press the right section of the switch

**NOTE:** To help prevent accidentally locking the keys in the car, the central locking system is designed to unlock the driver's door immediately if the key is left in the ignition switch and the car is locked using the lock button on the door. **A sound from the lock will be audible at this time.**

Please note that this function will not unlock the doors if the engine is running.

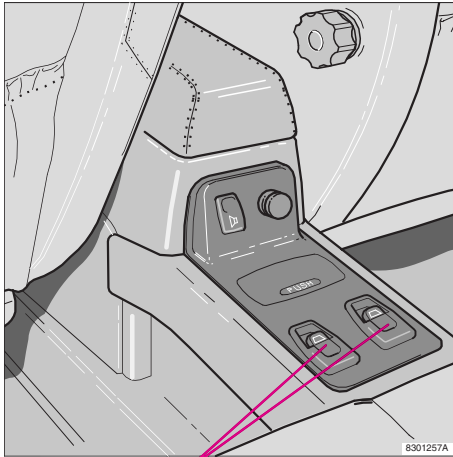

*Window control buttons in rear console*

### **Cut-off function - rear windows**

To prevent the rear windows from being opened with the buttons in the rear seat, pull up the front edges of both rear window buttons on the driver's door quickly and release them. An indicator lamp near the buttons will light up to remind the driver that the rear seat window buttons are disabled.

Repeat this procedure to reactivate these buttons.

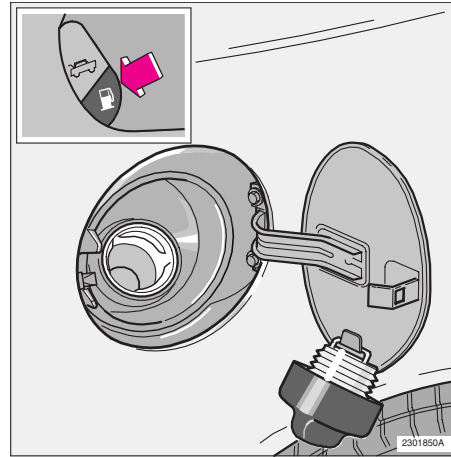

### **Opening the fuel tank cover**

The fuel tank cover is locked and must be popped open using the control on the driver's door. Pull the control button toward you to release the fuel tank cover.

See page 106 for instructions on manually opening the fuel tank cover.





---

---

## Chapter 3 - Body and interior

Convertible top/wind deflector	40
Storage compartments	42
Keys, doors and locks	43
Remote keyless entry system	44
Alarm	45
Front seats	47
Rear/side view mirrors	50
Interior lights, Vanity mirrors	52
Long load storage	53
Hood	54
Opening the trunk	55
Trunk light, Spare tire, Jack	56
Securing cargo, Avoiding battery drain	57

## Electrically operated convertible top

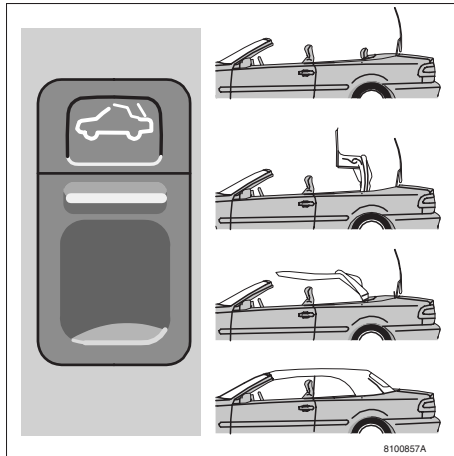

Electrically operated convertible top

### Electrically operated convertible top

#### To lower the convertible top:

- Start the engine. **The car must be at a standstill, the parking brake must be ON and the trunk must be closed when raising/lowering the convertible top.** The gear selector must be in position P (automatic transmission) or in neutral (manual transmission).
- Press and hold down the *lower* section of the control switch (an indicator lamp will light up and all four windows will automatically be lowered slightly) until the convert-

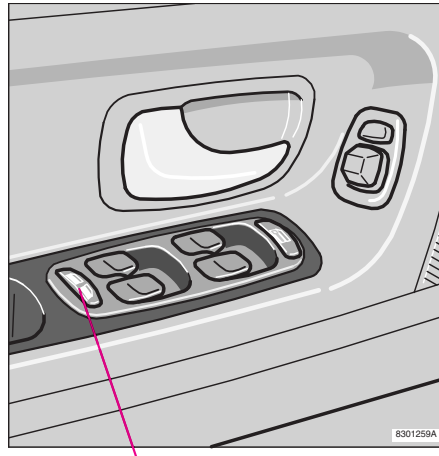

"All windows" control button

ible top is completely lowered. A chime will indicate when the top is completely down and properly in place in the storage compartment. The windows can then be raised/lowered with the "All windows" button on the driver's door.

#### To raise the convertible top:

- Press and hold down the *upper* section of the control switch until the convertible top is completely raised. A chime will indicate when the top is properly in position. Check that the cover over the convertible top storage compartment closes completely.

**Movement of the convertible top can be stopped at any time by releasing the control switch.**

#### WARNING!

- The convertible top must not be obstructed in any way when it is being raised or lowered.
- The rear seat should not be occupied while the convertible top is being raised or lowered.
- Anyone near the car should be well clear of the convertible top's moving parts before it is raised or lowered.
- Children should never be allowed to play with the convertible top control switch.

**CAUTION:** If the cover over the convertible top storage space is not **completely closed**, the trunk lid should NOT be opened to help avoid scratching the paint.

#### NOTE:

- The electrically operated convertible top has an overload protecting circuit breaker that is activated when an object blocks the top when it is in motion. If this occurs, remove the object and wait 20 seconds for the circuit breaker to reset before trying to raise/lower the top again. **See page 107 for fault tracing information and instructions on manually raising the convertible top.**
- The trunk cannot be opened and the power windows/power antenna cannot be operated while the convertible top is being raised/lowered.

## Electrically operated convertible top, Wind deflector

### CAUTION:

- Be sure there is sufficient clearance above the car before raising/lowering the convertible top.
- Volvo recommends that you raise the convertible top and close the windows when you leave the car to help deter thefts and to protect the interior from rain, windblown dust, etc.
- No objects should be placed in the convertible top storage compartment. This could damage the convertible top mechanism.
- Roof racks may not be attached to or placed on the convertible top. See page 70 for information on trunk-mounted luggage racks.
- Ice scrapers should not be used to remove snow from the convertible top.
- Do not lower the convertible top if it is frozen. The top should not be raised/lowered if the temperature is below 32° F (0° C).
- The top should be completely dry before it is lowered and stored in the storage compartment to help prevent damage from mildew.

See page 113 for information on cleaning the convertible top.

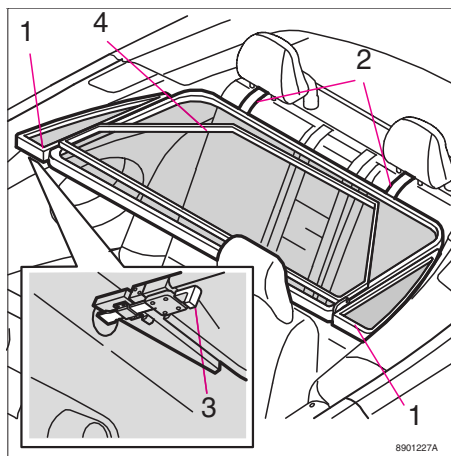

### Wind deflector (option/ accessory)

#### Installing the wind deflector:

- Fold out the panels on the sides of the wind deflector (1).
- Slide the two metal slats on the wind deflector under the rear seat head restraints (2). Slide them carefully to avoid damaging the upholstery.
- Press the catches (3) into the holes provided in the side panel until they click into place.
- Raise the wind deflector (4) 90°.

**NOTE:** The panels on the sides of the wind deflector can be folded under so that the deflector can be stored in the trunk. The catches (3) must be pushed in (toward the center of the car) before the panels can be folded.

### WARNING!

The wind deflector must be securely attached to help avoid injury to the occupants of the car or to other motorists.

## Storage compartments

**WARNING!**

Packages on the rear window shelf can obscure vision and may become dangerous projectiles in the event of a sudden stop or an accident.

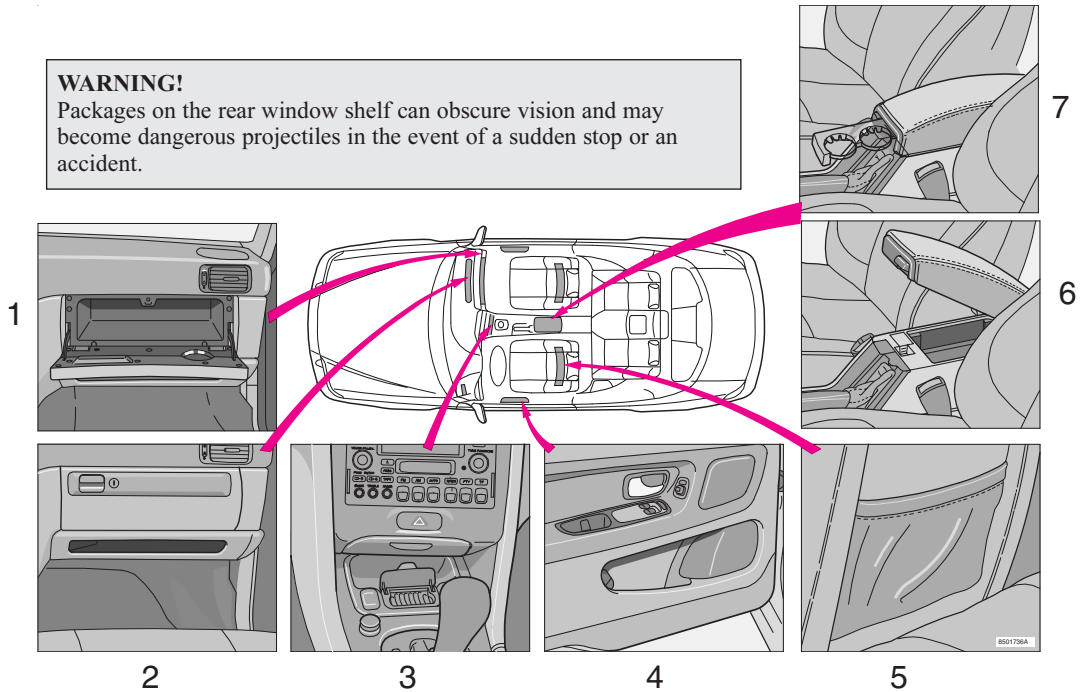

1 Glove compartment

2 Shelf under glove compartment

3 Coin holder

4 Compartment in door

5 Pocket on rear of front seat

6 Compartment between front seats

7 Cup holder

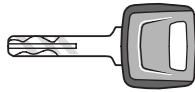
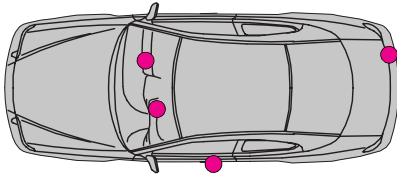

### Master key

This key operates all locks (ignition switch/steering wheel lock, driver's door, trunk and glove compartment).

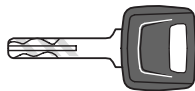
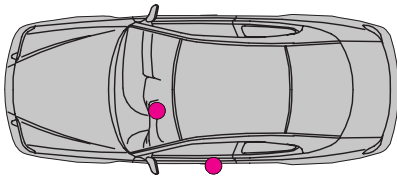

### Service key

This key operates the driver's door and the ignition switch/steering wheel lock.

8300836A

### Doors and locks

Your car is equipped with a central locking system. The key, used on the driver's door, the remote control or central locking button, will lock/unlock both doors and the trunk.

- **Turn the key once** to unlock the driver's door only.
- **Turn the key again (within 10 seconds)** to unlock both doors and the trunk. One turn with the key towards lock in the drivers door locks both doors and the trunk.
- Use the switch on the front door armrests to lock/unlock the car from the inside. Check the action of the button on the other door to verify its function (lock/ unlock).

#### WARNING!

If the doors are locked while driving, this may hinder rapid access to the occupants of the car in the event of an accident. (Also see information on "Child safety locks").

#### NOTE:

- If a door is not closed completely, the courtesy lights will stay on and a chime will sound until the door is closed.
- As an added anti-theft measure, new keys have been developed which may take slightly longer to copy or replace if the original keys are misplaced. Duplicate keys may be ordered from your Volvo retailer.

### Immobilizer (start inhibitor)

Each of the keys supplied with your car contains a coded transmitter and receiver (transponder). The code in the key is transmitted to an antenna in the ignition switch where it is compared to the code stored in the start inhibitor module. The car can only be started if a properly coded key is used.

If you misplace a key, take the other keys to an authorized Volvo retailer. The existing code in the start inhibitor module and all the keys will be erased as an anti-theft measure and a new code will be programmed in.

**NOTE:** Not more than one of the keys for your car should be kept on the same key ring. This could cause conflicting signals to be transmitted to the ignition switch, making it impossible to start the car.

This device complies with part 15 of the FCC rules. Operation is subject to the following condition: (1) This device may not cause harmful interference, and (2) this device must accept any interference received, including interference that may cause undesired operation.

The key number codes are stamped on a separate tag supplied with the keys. This tag should be separated from the key ring and kept in a safe place.

## Remote keyless entry system

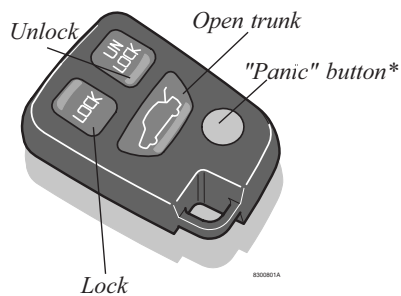

### Remote keyless entry system

Your car is equipped with a remote control transmitter. This transmitter uses a radio frequency which will allow "keyless" entry into the passenger compartment or the trunk. You will be supplied with two coded key ring transmitters, which will enable you to lock/unlock both doors and the trunk from a distance of 10-15 feet (3-5 meters).

On vehicles equipped with an alarm, the alarm will also be activated/deactivated by this system.

#### The car can also be locked/unlocked with the key.

As an extra security precaution in certain situations (valet parking, etc.), Volvo recommends that the transmitter not be included when the keys are given to anyone. The service key can be used instead. If one of the transmitters is misplaced, contact the nearest authorized Volvo retailer for assistance.

### Using the remote control

- Press the **LOCK** button once to lock both doors and the trunk.
- Press the **UNLOCK** button **once** to unlock the driver's door only. Press this button again (within 10 seconds) to unlock both doors and the trunk.
- Press the **OPEN TRUNK** button *twice* within 3 seconds to pop open the trunk.

#### NOTE:

- If only the driver's door is unlocked, the lock will automatically re-engage (re-lock) and the alarm will reset after 2 minutes unless the door has been opened.
- The lock/unlock and alarm features can also be utilized by using the keys. See page 43.
- If the alarm LED glows continuously for 5 seconds, this indicates a fault in the system or that a door is not properly closed.
- To avoid leaving your keys in the car, make a habit of always locking the car with the remote control.

#### WARNING!

Volvo does not recommend using the transmitter to lock the doors from inside the car. On cars equipped with an alarm, the alarm would be activated and would sound when one of the doors is opened. The doors must not be locked using the remote transmitter while the vehicle is occupied. In case of an accident, this may hinder rapid access to the occupants of the vehicle. The alarm will also sound on models equipped with this feature.

This device complies with part 15 of the FCC rules. Operation is subject to the following condition: (1) This device may not cause harmful interference, and (2) this device must accept any interference that may cause undesired operation.

\* See also page 45.

## Alarm (certain models)

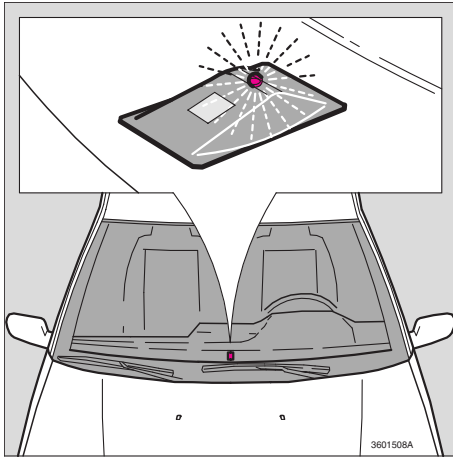

LED alarm status indicator

### Alarm

The radio signal emitted from the transmitter, which is used to set/unset the alarm, is a "rolling code" signal. This means that the signal is changed randomly for each transmission and is intended to help prevent unauthorized recording of the code.

When armed (set), the alarm continuously monitors a number of points on the car. The following conditions will set off the alarm:

- The hood is opened
- The trunk is opened
- A door is opened
- The ignition switch is tampered with

- The car is lifted or towed (if the car is equipped with the optional inclination sensor)
- The battery is disconnected (if the car is equipped with the optional backup battery siren). The alarm will sound for ten 30 second intervals, with a 5 second pause between intervals. This function cannot be interrupted.

### Arming (setting) the alarm

Press the LOCK button on the remote control, lock the car using the key in the driver's door or press the central lock button on one of the doors with the door open. One long flash of the turn signals will confirm that the alarm is set.

### Disarming the alarm

Press the UNLOCK button on the remote control or unlock the doors with the key.

### Turning off (stopping) the alarm

If the alarm is sounding, it can be stopped by pressing the UNLOCK button on the remote control or by unlocking the driver's door with the key.

If the alarm is stopped with the remote control, this will be confirmed by two short flashes from the turn signals.



### "Panic" function

In an emergency situation, this feature can be used to attract attention.

Activate the "panic" function by pressing the red panic button on the remote control for at least 3 seconds or by pressing this button twice within 3 seconds. The turn signals will flash, the interior lights will go on and the alarm will sound.

The function can be turned off by pressing any of the buttons on the remote control or will stop automatically after 25 seconds.

**NOTE:** This button will **NOT** unlock the car.

### Audible alarm signal

An audible alarm signal is given either by a separate alarm horn or by the optional backup siren. One alarm cycle lasts for 30 seconds.

### Visual alarm signal

The visual alarm signal is given by flashing all turn signals and turning on the interior lighting for approximately 5 minutes.

## Alarm

### Automatic reset function

If only the driver's door is unlocked with the remote control, the lock will automatically reengage (re-lock) and the alarm will reset after 2 minutes unless the door has been opened.

### Temporarily disconnecting the alarm sensor(s)

In certain situations it may be desirable to disconnect the **optional** alarm sensors, particularly the inclination sensor, if, for example, you drive your car onto a ferry where the rocking of the boat could trigger the alarm.

To temporarily disconnect the sensor(s) from the alarm system:

- With both doors closed, switch off the ignition and remove the key from the ignition switch
- Press the locking (left) side of the central locking button on the driver's door for at least 3 seconds
- The doors will first lock and then unlock after 3 seconds to confirm that the sensors have been disconnected

The car can then be locked in the usual way to set the alarm.

**NOTE:** The sensors will automatically be reconnected to the alarm system the next time the ignition is switched on.

### LED alarm status signals

The status of the alarm system is indicated by the red LED at the top center of the dash:

- LED off - the alarm is not armed (set)
- LED flashes once per second - the alarm is armed (set)
- LED flashes rapidly before the ignition is switched on - the alarm has been triggered
- LED flashes rapidly for 15 seconds after the ignition has been switched on - a fault has been detected in the alarm system. Contact a Volvo retailer.

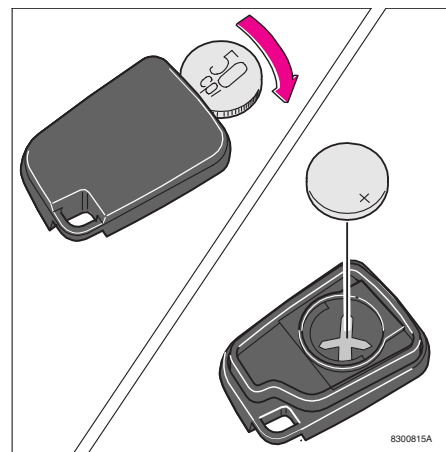

### Battery

Each remote transmitter is powered by a three-volt battery, type CR 1616. If the range of the transmitter is noticeably reduced, this indicates that the battery is weak and should be replaced.

**Replacement:** Remove the battery cover on the back of the transmitter with a coin. Replace the battery. Reinstall the cover, making sure it is secured tightly to help protect the transmitter.

**CAUTION:** Do not attempt to service or repair any components of the alarm system yourself. This should only be done by an authorized Volvo retailer.



## Electrically operated seats with memory function

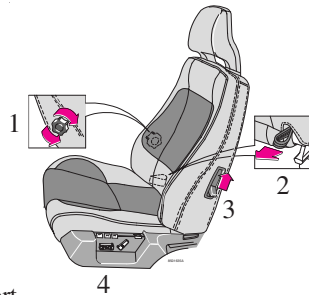

- 1 Lumbar support
- 2 Strap for controlling front seat for rear seat passengers
- 3 Backrest release control lever
- 4 Power seat control panel

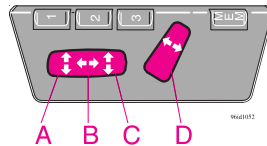

Power seat control panel

A - seat front (raise/lower), B - forward/rearward,  
C - seat rear (raise/lower), D - backrest tilt

### WARNING!

The power seats are operable with the ignition OFF. Therefore, children should never be left unattended in the car.

- Do not adjust the seat while driving. The seat should be adjusted so that the brake pedal can be depressed fully. In addition, position the seat as far rearward as comfort and control allow. The seat rails on the floor must not be obstructed in any way when the seat is moved.
- Make sure the seats are securely locked in position after they have been adjusted.

Memory programming buttons

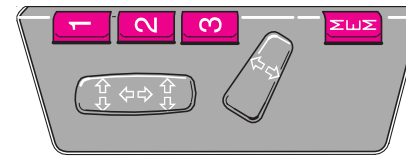

### Programming the seat's memory

Three seat positions can be programmed using the memory function. To program a seat position:

- 1 Adjust the seat to the desired position.
- 2 Depress the MEM button.
- 3 Press button 1 to program the current position of the seat. Buttons 2 and 3 can be programmed in the same way.

### Moving the seat to a programmed position

- Depress button 1, 2 or 3 until the seat stops in the programmed position.
- If the button is released before the seat has reached the programmed position, the seat will stop as a safety precaution.

**NOTE:** The seat has an overload protector which engages if an object blocks the movement of the seat. If this happens, remove the object and wait 20 seconds before operating the seat again.

**Movement of the seat can be STOPPED at any time by pressing any button on the power seat control panel.**

## Front seats

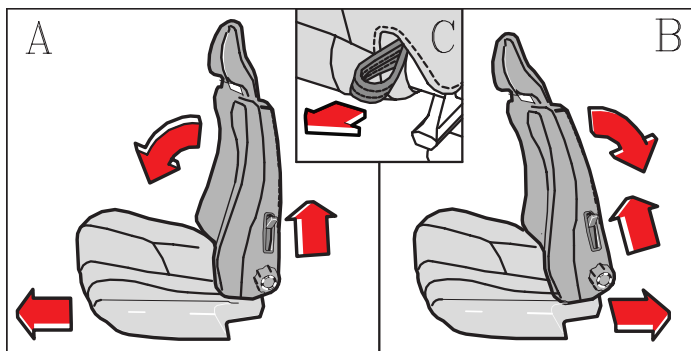

8503973a

### Tilting the backrests - moving the seats

#### Tilting the backrest

The backrests are locked in the upright position and can be tilted forward to allow access to the rear seat.

- 1 Lift the control lever on the side of the front seat (A)
- 2 Tilt the backrest forward to reach objects in the rear seat.

#### Moving the seat forward

- 1 Lift and hold up the control lever on the side of the front seat (A).
- 2 Tilt the backrest forward (B) and release the lever.

**Electrically operated seats:** The seat will slide forward until it reaches the forward-most position.

**Manually operated passenger's seat\*:** When the backrest has been tilted forward until it locks into position, the seat can be moved forward/rearward *without holding the control on the side of the seat.*

#### To tilt up the backrest to its normal position:

- 1 Press the backrest slightly forward and pull the control lever up to release the backrest locking mechanism.
- 2 Tilt the backrest toward the rear of the car.

- 3 **Electrically operated seats:** Push up the control lever, move the backrest to the upright position and release the lever. The seat will move to its previously programmed position.

**Manually operated passenger's seat\*:** move the seat to the desired position.

#### To exit the rear seat:

- 1 Pull the strap on the lower inside corner of the seat (C) and push the backrest forward. Release the strap.
- 2 The seat will slide forward until it reaches its forward-most position (electrically operated seats). If the car is equipped with a manually operated passenger's seat, push the seat forward.

\* Please see the following page for information on adjusting the manually operated passenger's seat.

**WARNING!** To stop a moving electrically operated seat; push the backrest slightly forward or backward.

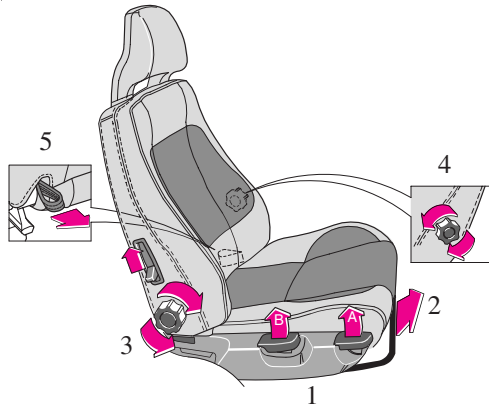

## Manually operated passenger's seat (certain models)

### 1 Height adjustment

The front section of the seat can be adjusted to 7 different height settings (lever A) and the rear section can be adjusted to 9 different height settings (lever B).

### 2 Forward-rearward seat adjustment

Pull the bar upward, then slide the seat forward or rearward to the desired position. Make sure that the seat is properly secured when you release the bar.

### 3 Backrest tilt

Rotate the control counterclockwise to tilt the backrest rearward and clockwise to tilt the backrest forward.

### 4 Lumbar support

### 5 Strap for controlling front seat (for rear seat passengers)

## Rear-view mirror

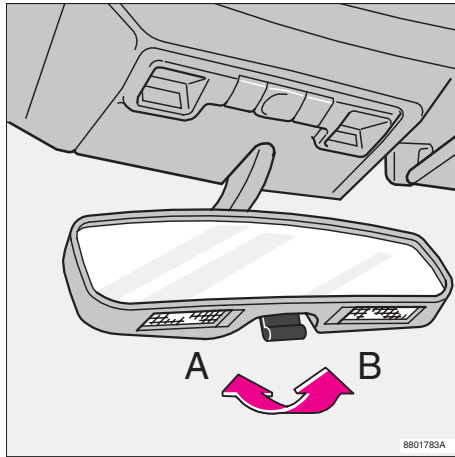

### Rear-view mirror

**A** Normal position

**B** Night position, reduces glare from following headlights

**CAUTION:** Never use ice scrapers made of metal as they can easily scratch the mirror surface.

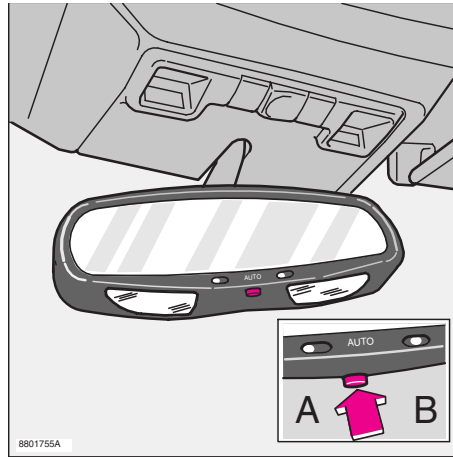

### Auto-dim function (certain models)

**A** Indicator light

**B** Sensor

The Auto-dim function reacts to high beams from the car behind you and switches the mirror automatically to "night" position.

**NOTE:** If the left indicator light (see A in the inset illustration to the left) is on, the Auto-dim function is ON. Press the button (see arrow) to turn the function ON or OFF.

## Electrically operated side-view mirrors, Front courtesy lights

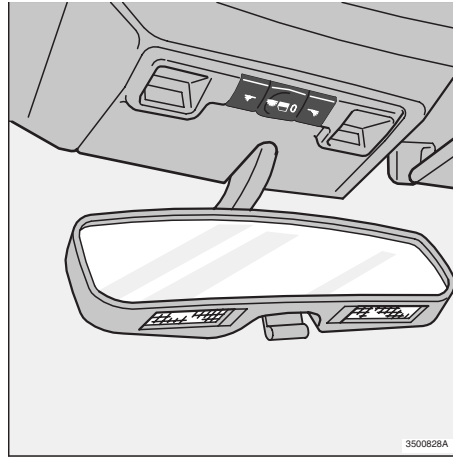
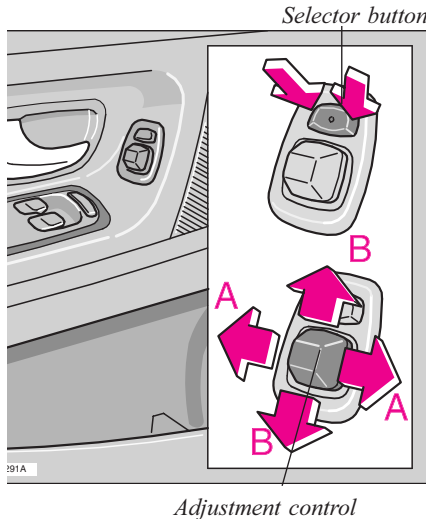

### Electrically operated side-view mirrors

The mirror control switches are located on the driver's door armrest. Press the left side of the selector button and then use the adjustment control to adjust the driver's door mirror. Press the right side of the selector button before adjusting the passenger door mirror.

**A** Horizontal adjustment





**B** Vertical adjustment

#### **WARNING!**

The mirrors should always be adjusted prior to driving. Objects seen in the wide-angle right side-view mirror are closer than they appear to be.

### Front courtesy lights

The front courtesy lighting consists of two reading lights for the front seat occupants.

-  Front and rear reading lights always on
-  Front and rear reading lights always off
-  Front and rear reading lights come on when a door is opened
-  Left or right reading light illuminates if the center switch is in position .

The courtesy lights remain illuminated for 30 seconds after the doors have been closed but will be switched off if the ignition is turned on or the doors are locked. If a door is not closed completely, the courtesy lights will stay on and a chime will sound until the door is closed.

## Vanity mirrors, Rear reading lights

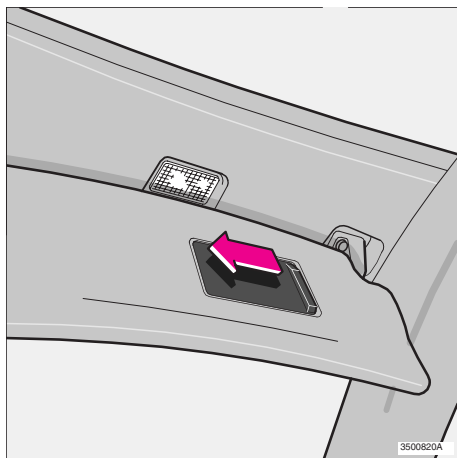

### Vanity mirrors

Fold down the sun visor and slide the cover to the side to illuminate the mirror. The illumination will be switched off when the cover is closed or if the sun visor is folded up.

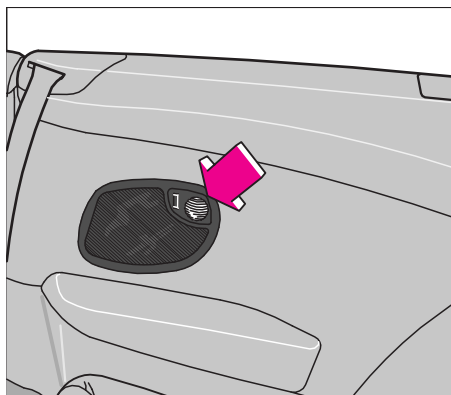

### Reading lights, rear seat

There are two reading lamps at opposite sides of the rear seat, near the armrests. These lamps can be turned on/off using the switch (see illustration to the left).

The switch can be set in three positions. In the first position the lamps are always off. In the second position the lamps will come on if one of the doors is opened. In the third position, the lamps are always on.

## Long load storage

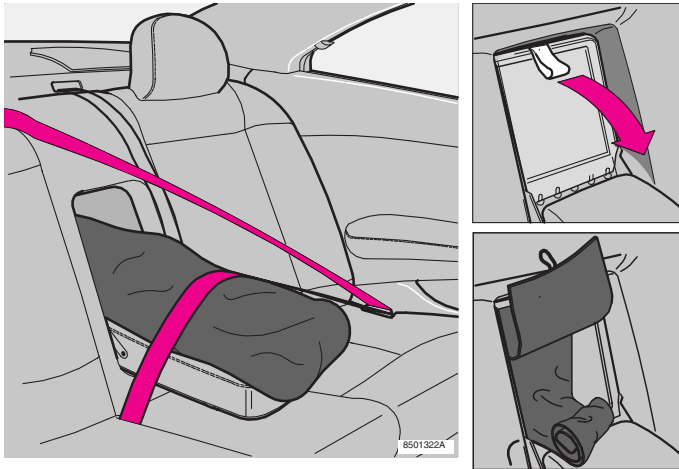

### **WARNING!**

Always turn the engine off and apply the parking brake when loading/unloading the vehicle. Place the transmission in the P (PARK) position to help prevent inadvertent movement of the gear selector.

Long loads should be secured to the folded down armrest to help prevent movement and possible injury in the event of sudden braking or stops. Any sharp edges should be covered with protective material.

### **Long load storage**

There is a flap located in the panel behind the rear seat which makes it possible to carry long loads such as skis, etc.

To open, pull the strap forward (see upper inset illustration).

Protective covers (for skis) should be used to avoid soiling or tearing the upholstery.

A bag for the object being transported is attached to this opening behind the backrest to help hinder access to the trunk when the convertible top is down.

Please note that the flap in the rear seat is only intended for light loads such as skis, carpets, etc.

Max length: 6 1/2 ft (2 meters)

Max weight: 55 lbs (25 kg)

## Hood

### *Hood release lever under dashboard*

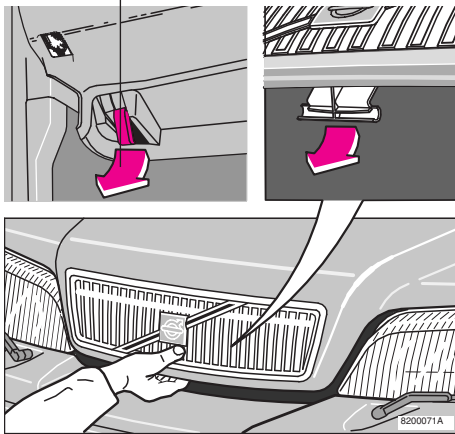

### *Hood release control under grille*

### To open the hood

- Pull the lever located under the left side of the dash to release the hood lock.
- Lift the hood slightly.
- Pull the release control on the inside of the lower edge of the grille toward you and lift the hood.

#### **WARNING!**

Check that the hood locks properly when closed.

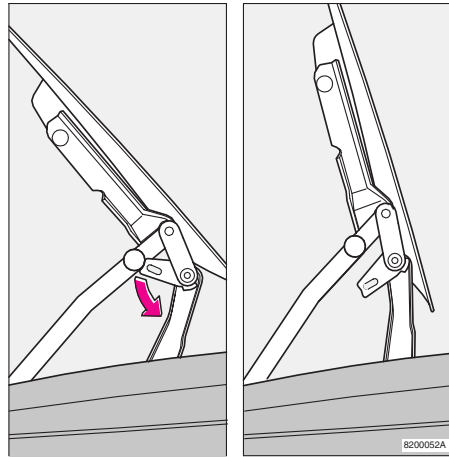

The hood normally opens to an angle of 57°.

The hood can be opened to the vertical position by rotating the hinge catches (see illustrations). The catches will return to their normal positions when the hood is closed.

Ensure adequate clearance in low-roof garages to avoid damaging the hood.



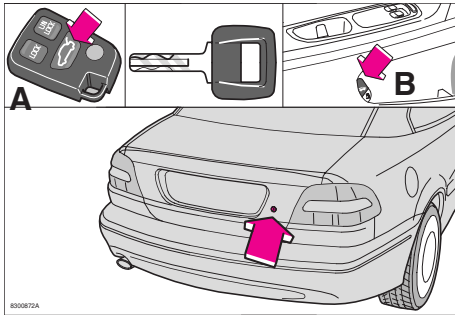

### Opening the trunk

The trunk can be opened by:

- Pressing the button on the remote control (A) twice within 3 seconds.
- Using the master key in the trunk lock
- Using the trunk control on the driver's door (B).

### Locking the trunk

The trunk lock is incorporated in the central locking system. This means that you can either lock or unlock the trunk when the driver's door is locked/unlocked.

The trunk can be disconnected from the central locking system by turning the key counterclockwise as shown in the illustration.



Withdraw the key in the horizontal position \*

\* In this position, the trunk cannot be opened with the control on the driver's door or with the remote control.

The trunk is now always locked. This feature can be used for e.g., valet parking. If you give only the service key to the driver, it will not be possible to gain access to the trunk. Please be aware that this setting may preclude access to the spare tire and jack.

**To reconnect the lock to the central locking system:**



Withdraw the key in the vertical position

### Opening the trunk from the inside (U.S. models only)

The C70 is equipped with a florescent handle on the inside of the trunk lid, which can be used in an emergency situation to open the trunk from the inside.

Pull the handle down to release the trunk lid.

**NOTE:** This handle is not intended to be used to anchor the trunk lid when long loads are being transported.

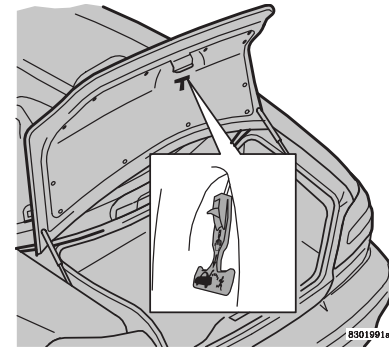

Opening the trunk from the inside

#### WARNING!

- Keep vehicle doors and trunk locked and keep keys out of a child's reach. Unsupervised children could lock themselves in an open trunk and risk injury. Children should be taught not to play in vehicles.
- On hot days, the temperature in the trunk or vehicle interior can rise very quickly. Exposure of people to these high temperatures for even a short period of time can cause heat-related injury or death. Small children are particularly at risk.

## Trunk light, Spare tire, Jack

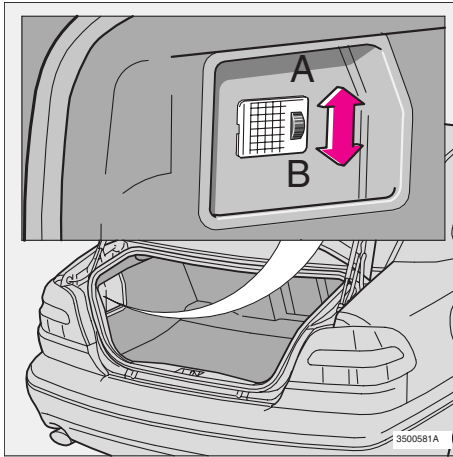

### Trunk light

- A Light always off
- B Light is on when the trunk lid is open

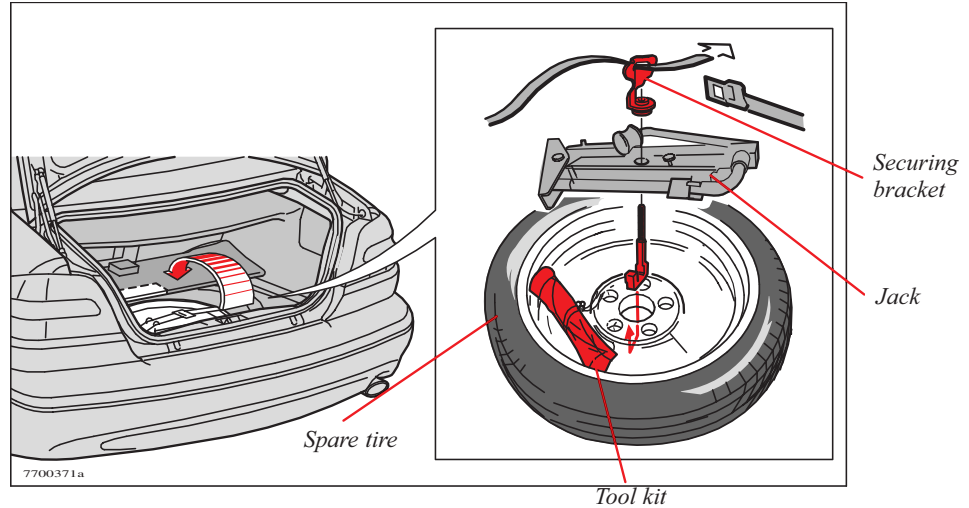

### Spare tire

The spare tire is located under the carpet in a special well under the floor of the trunk. The jack is placed inside the wheel rim.

#### **WARNING!**

Make sure that the jack is properly secured in the wheel rim with the securing bracket. The belt must also be threaded through the slot in the securing bracket (see illustration) and properly fastened to help keep the spare wheel/jack in place in the event of a sudden stop.

**NOTE:** See pages 90-91 for information on how the jack should be used.

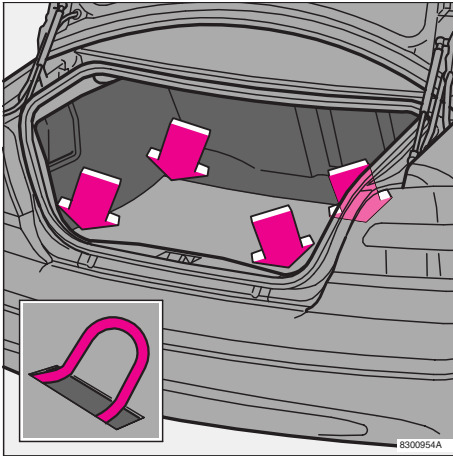

*Eyelets in trunk*

### Securing cargo

As a safety precaution, your car is equipped with four eyelets to which straps can be attached to secure luggage.

#### **WARNING!**

The eyelets are not to be used as passenger restraints or as anchorages for child restraints.

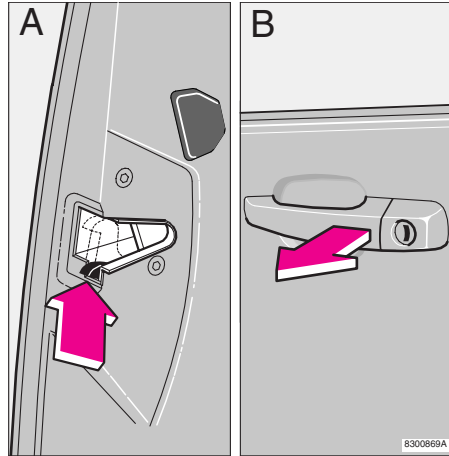

### Avoiding battery drain

The courtesy lights and the warning lights in the rear of the doors come on when a door is opened.

- To avoid battery drain when the doors are opened for prolonged periods, these lights can be switched off by pressing the lock mechanism (A) located in the rear facing side of the driver's door.
- To return the lights to their normal function, pull the door handle out (B) and use a small screwdriver to push the lock mechanism back to its original position before closing the door.



---

---

## Chapter 4 - Starting and driving

Fuel requirements, Refueling	60
Driving economy	63
Starting the engine	64
Manual transmission	65
Automatic transmission	66
Points to remember	68
Trunk-mounted luggage racks	70
Emergency towing	71
Vehicle towing information	72
Jump starting	73
Brake/Stability systems	74
Trailer towing	76
Winter driving	77

## Fuel requirements

### NOTE - ENGINE OIL:

Although some oil consumption occurs during normal engine operation, more oil is consumed when the engine is new as the internal parts generate higher friction while wearing-in to each other. **From the time the engine is new until the first service is performed, the oil consumption could be higher than normal. For this reason, it is especially important to check the oil every time you refuel your car during this period. See page 122-123.**

In general, the rate of oil consumption depends on such factors as: engine temperature, length of trip, driving conditions, oil viscosity and quality, engine speed and acceleration/deceleration.

Checking your engine oil level each time the car is refueled is one of the most important items you can perform to help keep your car in good running order.

### Manual transmission

The following speeds should not be exceeded during the break-in period:

	<b>Up to 600 miles (1000 km)</b>	<b>600 - 1,200 miles (1000 - 2000 km)</b>
<b>1st gear</b>	20 mph (30 km/h)	25 mph (40 km/h)
<b>2nd gear</b>	30 mph (50 km/h)	40 mph (70 km/h)
<b>3rd gear</b>	45 mph (80 km/h)	65 mph (100 km/h)
<b>4th gear</b>	70 mph (110 km/h)	80 mph (130 km/h)
<b>5th gear</b>	80 mph (130 km/h)	95 mph (150 km/h)

**Posted speed limits should not be exceeded.**

### Deposit control (detergent) gasoline

Volvo recommends the use of detergent gasoline to control engine deposits. Detergent gasoline is effective in keeping injectors and intake valves clean. Consistent use of deposit control gasolines will help ensure good driveability and fuel economy. If you are not sure whether the gasoline contains deposit control additives, check with the service station operator.

### Unleaded fuel

Each Volvo has a three-way catalytic converter and must use only unleaded gasoline. U.S. and Canadian regulations require that pumps delivering unleaded gasoline be labelled "UNLEADED". Only these pumps have nozzles which fit your car's filler inlet. It is unlawful to dispense leaded fuel into a vehicle labelled "unleaded gasoline only". Leaded gasoline damages the three-way catalytic converter and the heated oxygen sensor system. Repeated use of leaded gasoline will lessen the effectiveness of the emission control system and could result in loss of emission warranty coverage. State and local vehicle inspection programs will make detection of misfueling easier, possibly resulting in emission test failure for misfueled vehicles.

**NOTE:** Some U.S. and Canadian gasolines contain an octane enhancing additive called methyl-cyclopentadienyl manganese tricarbonyl (MMT). If such fuels are used, your Emission Control System performance may be affected, and the Malfunction Indicator Lamp located on your instrument panel may light. If this occurs, please return your vehicle to an authorized Volvo retailer for service.

### Octane rating

Volvo engines are designed for optimum performance on unleaded premium gasoline with an octane rating AKI of 91 or above. AKI (ANTI KNOCK INDEX) is an average of the Research Octane Number, RON, and the Motor Octane Number, MON. (RON + MON/2).

The minimum octane requirement is AKI 87 (RON 91).

### Fuel Formulations

Do not use gasoline that contains lead as a knock inhibitor, and do not use lead additives. Besides damaging the exhaust emission control systems on your car, lead has been strongly linked to certain forms of cancer.

Many fuels contain benzene as a solvent. Unburned benzene has been strongly linked to certain forms of cancer. If you live in an area where you must fill your own gas tank, take precautions. These may include:

- standing upwind away from the filler nozzle while refueling
- refueling only at gas stations with vapor recovery systems that fully seal the mouth of the filler neck during refueling
- wearing neoprene gloves while handling a fuel filler nozzle.

### Use of Additives

With the exception of gas line antifreeze during winter months, do not add solvents, thickeners, or other store-bought additives to your car's fuel, cooling, or lubricating systems. Overuse may damage your engine, and some of these additives contain organically volatile chemicals. Do not needlessly expose yourself to these chemicals.

### Carbon Monoxide – Important Warning

Carbon monoxide is a poisonous, colorless, and odorless gas. It is present in all exhaust gases. If you ever smell exhaust fumes inside the vehicle, make sure the passenger compartment is ventilated, and immediately return the vehicle to your retailer for correction.

### Gasoline containing alcohol and ethers

#### "Oxygenated fuels"

Some fuel suppliers sell gasoline containing "oxygenates" which are usually alcohols or ethers. In some areas, state or local laws require that the service pump be marked indicating use of alcohols or ethers.

However, there are areas in which the pumps are unmarked. If you are not sure whether there is alcohol or ethers in the gasoline you buy, check with the service station operator. To meet seasonal air quality standards, some areas require the use of "oxygenated" fuel.

Volvo allows the use of the following "oxygenated fuels; however, the octane ratings listed on this page must still be met.

#### **Alcohol — Ethanol**

Fuels containing up to 10% ethanol by volume may be used.

Ethanol may also be referred to as Ethyl alcohol, or "Gasohol".

#### **Ethers — MTBE**

Fuels containing up to 15% MTBE may be used.

## Fuel requirements, Refueling

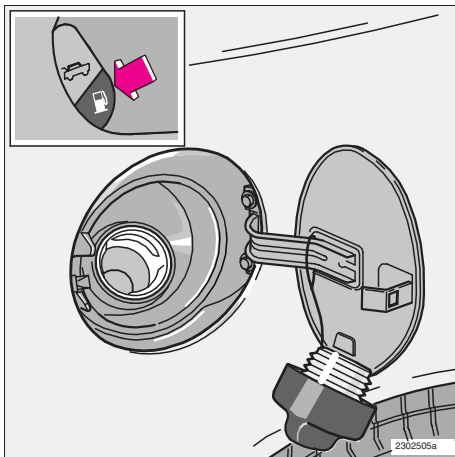

Fuel filler door control on driver's door

### Refueling

The fuel tank holds approximately 18 US gal. (68 liters) with sufficient volume left over to accommodate possible expansion of the fuel in hot weather. Be aware that the "usable" tank capacity will be somewhat less than the specified maximum. When the fuel level is low, such factors as ambient temperature, the fuel's "Reid vapor pressure" characteristics, and terrain can affect the fuel pumps' ability to supply the engine with an adequate supply of fuel. Therefore, it is advisable to refuel as soon as possible when the needle nears the red zone, or when the fuel warning light comes on.

### Fuel filler door

The fuel filler door (on the right rear fender) is locked and must be popped open using the control on the driver's door.

**Open fuel filler cap slowly during hot weather conditions.**

**WARNING!** Never carry a cell phone that is **switched on** while refueling your vehicle. If the phone rings, this may cause a spark that could ignite gasoline fumes, resulting in fire and injury.

### CAUTION:

- Do not refuel with the engine running. Turn the ignition off or to position I. If the ignition is on, an incorrect reading could occur in the fuel gauge.
- After refueling, close the fuel filler cap by turning it clockwise until it *clicks* into place\*.
- Allow for fuel expansion by not overfilling the tank. Overfilling could also cause damage to the emission control systems.
- Avoid spilling gasoline during refueling. Gasolines containing alcohol can cause damage to painted surfaces, which may not be covered under the New Vehicle Limited Warranty.
- Do not use gasolines containing methanol (methyl alcohol, wood alcohol). This practice can result in vehicle performance deterioration and can damage critical parts in the fuel system. Such damage may not be covered under the New Vehicle Limited Warranty.

\* If the fuel filler cap is not closed tightly or if the engine is running when the car is refueled, the Malfunction Indicator Lamp may indicate a fault. However, your vehicle's performance will not be affected. Use only Volvo original or approved fuel filler caps.



### Economical driving conserves natural resources

Better driving economy may be obtained by thinking ahead, avoiding rapid starts and stops and adjusting the speed of your vehicle to immediate traffic conditions. Observe the following rules:

- Bring the engine to normal operating temperature as soon as possible by driving with a light foot on the accelerator pedal for the first few minutes of operation. A cold engine uses more fuel and is subject to increased wear.
- Whenever possible, avoid using the car for driving short distances. This does not allow the engine to reach normal operating temperature.
- Drive carefully and avoid rapid acceleration and hard braking.
- Do not exceed speed limit.
- Avoid carrying unnecessary items (extra load) in the car.
- Maintain correct tire pressure. Check tire pressure regularly (check when tires are cold).
- Remove snow tires when threat of snow or ice has ended.
- Note that trunk-mounted luggage racks increase air resistance and thereby fuel consumption.
- Avoid using automatic transmission kickdown feature unless necessary.

- Avoid using the air conditioning when it is not required. When engaged, the air conditioner's compressor places an additional load on the engine. However, please note that fuel consumption is lower with the air conditioning on than it is when driving with the air conditioning switched off and the windows down.
- If your car is equipped with the optional Trip Computer, utilizing the fuel consumption modes can help you "learn" how to drive more economically.

### Other factors which decrease gas mileage are:

- Dirty air cleaner
- Dirty engine oil and clogged oil filter
- Dragging brakes
- Incorrect front end alignment

Some of the above mentioned items and others are checked at the standard Maintenance Service intervals.

**NOTE:** (D)rive or 5th gear (manual transmissions) should be used as often as possible to help improve fuel economy.

## Starting the engine

### Starting and stopping

1. Fasten the seat belt.

#### **WARNING!**

Before starting, check that the seat, steering wheel and mirrors are adjusted properly. Make sure the brake pedal can be depressed completely. Move the seat closer if necessary. Refer to section “front seats”.

2. Apply the parking brake, if not already set. The gear selector (**automatic transmission**) is locked in the (P)ark position (**SHIFT-LOCK**).  
**Manual transmission: the clutch must be fully depressed.**
3. **Without touching the accelerator pedal**, turn the ignition key to the starting position\*. Allow the starter to operate for up to 10 seconds. Release the key as soon as the engine starts. If the engine fails to start, repeat step 3.  
For cold starts at altitudes above 6000 ft (1800 meters), depress the accelerator pedal halfway and turn the key to the starting position. Release the pedal slowly when the engine starts.

\* If the key is left in the Drive position (position II) for more than 30 seconds, it must be turned to position 0 and then turned to the Start position (position III) again in order to start the car. See page 21 for ignition key positions.

4. To release the gear selector from the (P)ark position (automatic transmission), the ignition key must be in position II and the brake pedal must be depressed. **See page 106 for instructions on manually releasing the SHIFTLOCK system.**

#### **NOTE: (Automatic transmission only)**

Your car is equipped with a **KEYLOCK** system. When the engine is switched off, the gear selector must be in the (P)ark position before the starting key can be removed from the ignition switch.

5. Select the desired gear. The gear engages after a slight delay (automatic transmission) which is especially noticeable when selecting R.

#### **CAUTION: (Automatic transmission only)**

The engine should be idling; never accelerate until after you feel the gear engage! Too-rapid acceleration immediately after selecting a gear will cause harsh engagement and premature transmission wear.

**NOTE:** Selecting P or N (automatic transmission) when idling at a standstill for prolonged periods of time will help prevent overheating of transmission oil.

#### **WARNING!**

Always place the gear selector (automatic transmission) in Park and apply the parking brake before leaving the vehicle. Never leave the car unattended with the engine running.

Always open the garage doors fully before starting the engine inside a garage to ensure adequate ventilation. The exhaust gases contain carbon monoxide, which is invisible and odorless but very poisonous.

**CAUTION:** Never race the engine **immediately after starting**. Oil flow may not reach some lubricating points fast enough to prevent engine damage. **Do not race the engine just prior to switching off!**

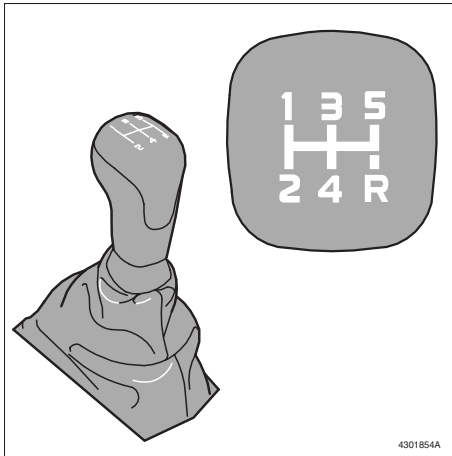

### Shift positions

Depress the clutch pedal completely when changing gears\*.

Remove your foot from the clutch pedal while driving.

Overdrive (5th gear) should be used as often as possible to help improve fuel economy. This gear can be engaged at speeds above approx. 50 mph (80 km/h).

**CAUTION:** Follow the shift pattern indicated on the gear shift knob when shifting up (e.g., do not shift directly from 2nd to 5th gear) to help avoid excessive wear on the transmission.

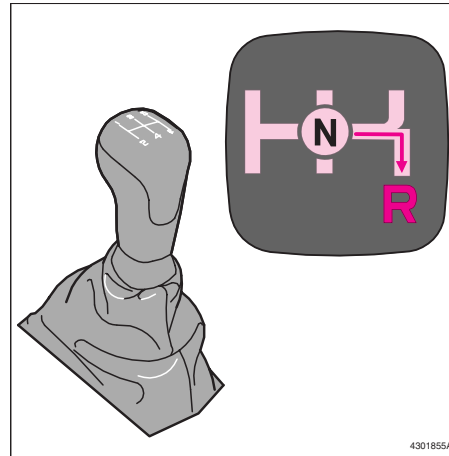

### Engaging reverse gear

The gear lever must first be moved to neutral in order to engage reverse gear.

**CAUTION:** Be careful that you do not inadvertently engage reverse while moving forward.

### \* Clutch interlock (manual transmission only)

The clutch must be fully depressed before you can start your car. If the clutch is not depressed, it will not be possible to start the engine.

## Automatic Transmission

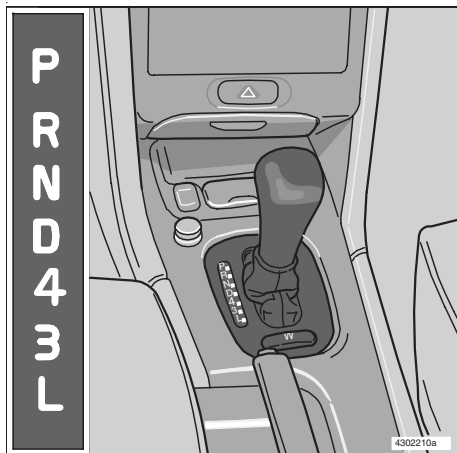

### P (Park)

Use this position when starting the engine or parking the car.

**Never use P while the car is in motion.**

The parking brake should be set whenever the car is parked.

**The gear selector is mechanically locked in the P position (SHIFTLOCK).** To release the gear selector from this position, the engine must be running (or the ignition key must be in position II) and the brake pedal must be depressed.

### WARNING!

Never leave the car unattended when the engine is running. If, by mistake, the gear selector is moved from P, the car may start moving.

### R (Reverse)

Never engage R while the car is moving forward.

### N (Neutral)

Neutral - no gear engaged. Use the parking brake.

### D (Drive)

D is the normal driving position and should be used as often as possible to help improve fuel economy. The car should not be moving when shifting from R to the D position.

### 4 (Intermediate gear)

The transmission will shift automatically between gears 4, 3, 2 or 1 from this position.

**The transmission cannot shift up to (D)rive from fourth gear.**

### 3 (Intermediate gear)

The transmission will shift automatically between gears 3, 2 and 1 from this position.

**The transmission cannot shift up to fourth gear or (D)rive from third gear.**

### L (Low gears)

The transmission is locked in gears 1 and 2 when the selector is in this position.

### NOTE:

- Gears 4, 3, or L can be used if you are driving in a mountainous area, towing a trailer or to increase engine braking effect.
- The transmission has a built-in limiter designed to help prevent excessive engine.

## Automatic transmission - adaptive system

The automatic transmission is controlled by an adaptive control system that constantly monitors the way in which the transmission functions. It senses and adapts each gear shift for optimal performance. The system also monitors your particular driving style and adapts gear shifting accordingly.

## Automatic Transmission

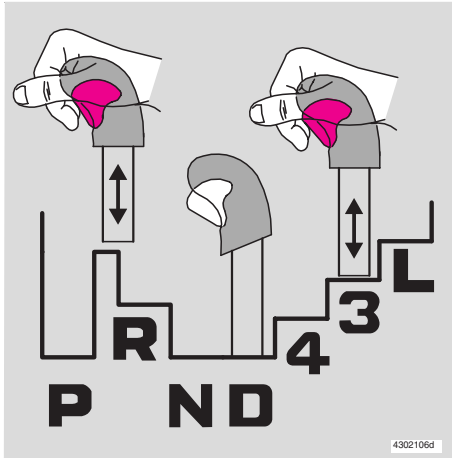

### Automatic transmission - shift gate positions

The gear selector can be moved freely between N and D.

Depressing the button on the front of the gear selector knob enables you to move the gear selector to positions P, R, N, D, 4, 3 and L.



### W Winter/Wet driving mode enhanced vehicle traction

- Mode W will only function if the gear selector is in the (D)rive position.
- Press the button at the base of the gear selector to engage/disengage this driving mode (see illustration).
- An LED in the button will light up to indicate that W is engaged and this will also be displayed in the instrument panel
- This mode may be selected for starting/moving off on slippery roads.

### Kickdown

Automatic shift to a lower gear (kickdown) is achieved by depressing the accelerator pedal fully and briskly. An upshift will occur when approaching the top speed for a particular gear or by releasing the accelerator pedal slightly.

Kickdown can be used for maximum acceleration or when passing at highway speeds.

## Points to remember

### Special tips - automatic transmission

- For driving down steep hills and when driving for prolonged periods at low speeds, position L should be selected. Avoid, however, repeated changes since this can cause overheating of the transmission oil. For driving on long continuous uphill gradients, select position 4 or 3.
- Never select P or R while the car is in motion.
- When initially selecting positions D, 4, 3, L or R, your right foot should press firmly on the brake pedal to ensure that the car is standing still with the engine idling.
- The gear selector should not be downshifted to L at speeds above 75 mph (125 km/h). **Always observe posted speed limits.**
- Do not hold the car stationary on an incline by using the accelerator pedal. Instead, apply the hand brake (parking brake). This prevents the transmission oil from becoming overheated.
- When towing a trailer, select shift position 4 or 3.
- While towing a trailer in hilly terrain, do not drive continuously at engine speeds above 4500 rpm to help avoid high engine oil temperatures.

### Before a long distance trip

It is always worthwhile to have your car checked at a Volvo retailer before driving long distances. Your retailer will also be able to supply you with bulbs, fuses, spark plugs and

wiper blades for your use in the event that problems occur.

If you prefer to check the car yourself, please note the following:

- Check that engine runs smoothly and that fuel consumption is normal.
- Check engine oil, coolant levels, and for possible fuel leakage.
- Check transmission oil level\*.
- Check condition of drive belts.
- Check state of charge of battery.
- Examine tires carefully (the spare tire as well), and replace those that are worn. Check tire pressures.
- The brakes, front wheel alignment, and steering gear should be checked by your Volvo retailer only.
- Check all lights, including high beams.
- Reflective warning triangles are legal requirement in some countries.
- Have a word with your Volvo retailer if you intend to drive in countries where it may be difficult to obtain correct fuel.
- Consider your destination. If you will be driving through an area where snow or ice are likely to occur, consider snow tires.

### Weight distribution affects handling

At the specified curb weight your car has a tendency to understeer, which means that the steering wheel has to be turned more than might seem appropriate for the curvature of a bend. This ensures good stability and reduces

the risk of rear wheel skid. Remember that these properties can alter with the vehicle load. The heavier the load in the trunk (max. 220 lbs, 100 kg), the less the tendency to understeer.

### Handling, roadholding

Vehicle load, tire design and inflation pressure all affect vehicle handling. Therefore, check that the tires are inflated to the recommended pressure according to the vehicle load. See "Tire pressure" section.

Loads should be distributed so that capacity weight or maximum permissible axle loads are not exceeded.

**WARNING!** It is recommended that tires of the same make and dimensions be used on all four wheels (including the use of snow tires). Do not use bias ply tires as this will adversely alter vehicle handling characteristics.

#### **WARNING! Floor mats**

An extra mat on the driver's floor can cause the accelerator pedal to catch. Check that the movement of the accelerator pedal is not impeded. Not more than one protective floor covering may be used at one time.

\* To prevent injury from contact with hot surfaces, do not inspect your car's transmission oil yourself. Have your car's transmission fluid level inspected by a qualified Volvo service technician.

### Cooling system

The risk for engine overheating is greatest, especially in hot weather, when:

- Towing a trailer up steep inclines for prolonged periods at wide open throttle and low engine rpm.
- Stopping the engine suddenly after high speed driving (so-called "after-boiling" can occur).
- To avoid overheating, the following rules should be followed:

Do not drive for prolonged periods at engine speeds above 4500 rpm if you are towing a trailer in hilly terrain.

Reduce speed and downshift when towing a trailer up long, steep inclines. The risk of overheating can be reduced by switching off the air conditioning system for a short time. Do not let the engine idle unnecessarily for prolonged periods.

Do not mount auxiliary lamps in front of the grill.

When the risk of overheating is imminent, or in the event of overheating (the temperature gauge goes repeatedly into, or stays continually in, the red section), the following precautions should be taken:

- Switch off the air conditioning system.
- Pull off the road, away from traffic, stop the car and put the gear lever into neutral. **Do not stop the engine!**
- Switch the heater to full (maximum)

position. Increase the engine speed to approx. 2000 rpm (twice idling speed) until the temperature begins to drop.

#### WARNING!

Do not remove coolant expansion tank cap. The coolant will be extremely hot.

See "Coolant" to check and top-up the coolant level if necessary.

**CAUTION:** Drive slowly and carefully if going through standing water (i.e. flooded roadways, etc.). Damage to engine could result if excess water is ingested through the air intake system.

Never drive the vehicle in water deeper than 1 foot (300 mm). See flood warning on page 7.

#### WARNING!

Do not drive with trunk lid open! A warning light in the instrument panel will indicate that the trunk is open. Poisonous exhaust gases may enter via the open trunk lid.

If the trunk lid must be kept open for any reason, proceed as follows:

- Close the windows.
- Set the ventilation system control to air flow to floor, windshield and side windows and blower control to its highest setting.

### Electrical system

When replacing the battery or when carrying out work involving the electrical system, the following should be observed:

- A battery connection to the wrong terminal will damage the diodes. Before connections are made, check the polarity of the battery with a voltmeter.
- If booster batteries are used for starting, they must be properly connected to minimize the risk of the diodes being damaged. For correct connection, see "Jump starting" section.
- Never disconnect the battery circuit (for example, to replace the battery) while the engine is running or the ignition is switched on, as this will immediately ruin the generator. Always make sure that all the battery connections are properly tightened.
- If any electrical welding work is performed on the vehicle, the battery's ground lead (negative cable) and all the connecting cables of the generator must be disconnected and the welder cables placed as near the welding points as possible.
- The radio must be turned off before the battery is disconnected.
- The anti-theft code must be re-entered before the radio will function properly.
- The electrical system in your car is designed to accommodate Volvo accessories. It also has an accessory connector located beneath the dashboard on the driver's side.

## Trunk-mounted luggage racks

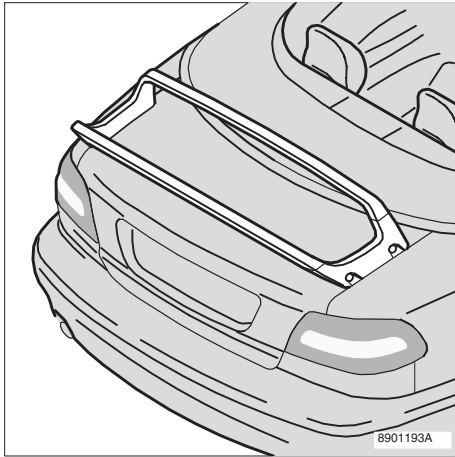

*Trunk-mounted luggage rack*

- Objects on the luggage rack should be positioned so that they do not cover the tail lights or obstruct the movement of the convertible top or the Roll Over Protection System (ROPS).

**NOTE:** A luggage rack is a supplementary loading space intended for light loads only. It is not intended for use with, or as a bicycle rack.

### Trunk-mounted luggage racks - special information

- Use sturdy luggage racks that can be securely attached to the car. Luggage racks specially designed for the Volvo C70 Convertible are available at your Volvo retailer.
- Regularly check that the luggage rack is securely attached.
- The maximum permitted load is 110 lbs (50 kg).



## Emergency towing (pulling of vehicle)

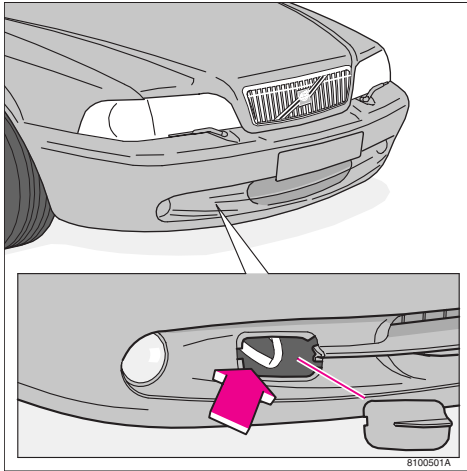

Front eyelet

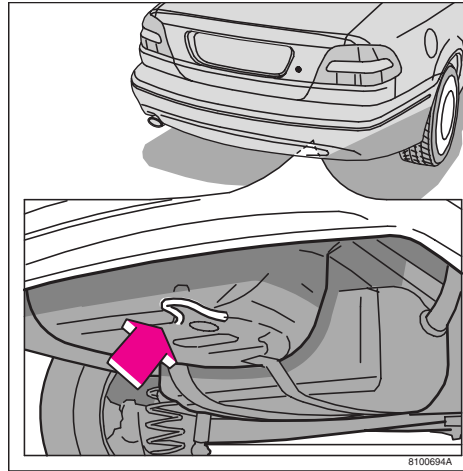

Rear eyelet

### Precautions when the car is in tow

- Steering must be unlocked.

#### Automatic transmissions only:

- Gear selector in position N. Check transmission oil level (see section titled "Transmission oil").
- Maximum speed: 50 mph (80 km/h).
- Maximum distance with front wheels on ground: 50 miles (80 km).
- If the battery is dead, it is not possible to release the gear selector by pressing the brake pedal. Release the gear selector manually, by pressing the **VERRIDE**

button near the base of the gear selector (see page 106 for instructions).

### WARNING!

- Remember that the power brakes and power steering will not function when engine is not running. The braking system will function but the brake pedal pressure required is 3 - 4 times above normal and greater steering effort must be exerted.
- The towing eyelets must not be used for pulling another vehicle out of a ditch or for any similar purpose involving severe strain.
- Do not use the towing eyelets to pull the car up onto a flat bed tow truck.

### CAUTION:

- Please check with state and local authorities before attempting this type of towing, as vehicles being towed are subject to regulations regarding maximum towing speed, length and type of towing device, lighting, etc.
- If the car's battery is dead, the engine must be jump started using an auxiliary battery (see page 73). Do not attempt to start the car by pushing or pulling it as this will damage the three-way catalytic converter(s).

## Vehicle towing information

### Towing cars with front wheel drive

Volvo recommends the use of flat bed equipment.

If wheel lift equipment must be used, please use extreme caution to help avoid damage to the car. **In this case, the car should be towed with the rear wheels on the ground if at all possible.**

If it is absolutely necessary to tow the vehicle with the front wheels on the ground, please refer to the towing information on the previous page.

#### CAUTION:

- Sling-type equipment applied at the front will damage radiator and air conditioning lines.
- It is equally important not to use sling-type equipment at the rear or apply lifting equipment inside the rear wheels; serious damage to the rear axle may result.
- If the car is being towed on a flat bed truck, the towing eyelets must not be used to secure the car on the flat bed. Consult the tow truck operator.

#### WARNING!

Do not use the towing eyelets to pull the car up onto a flat bed tow truck.

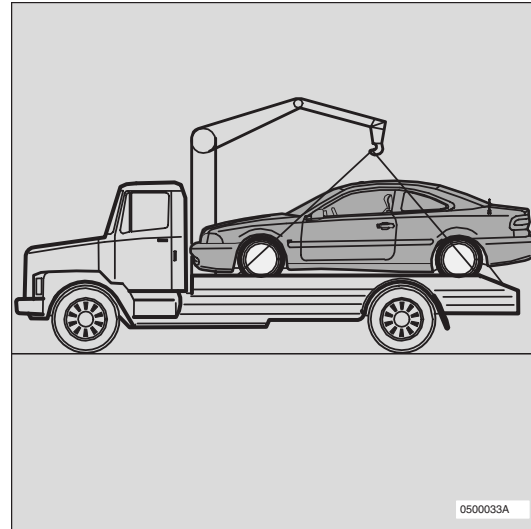

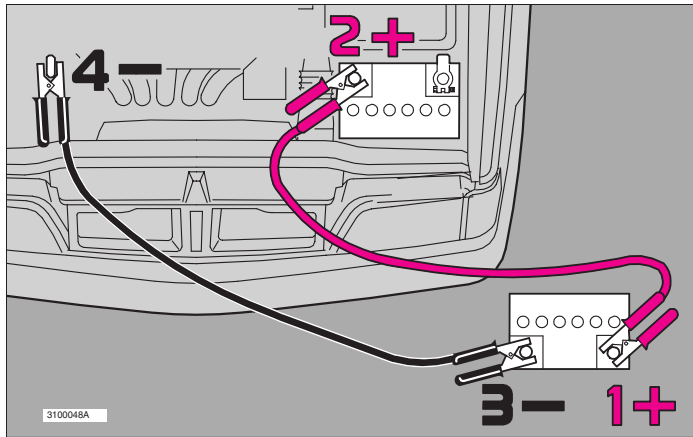

### Jump starting

If the 12-volt booster battery to be used is in another car, check that the cars are not touching to prevent premature completion of a negative circuit. Note the position of the battery terminals and using jumper cables:

- First connect the booster battery positive (+) terminal (1) to car battery positive (+) terminal (2).
- Then connect the booster battery negative (-) terminal (3) to a stationary solid metal part on the engine at a point away from the battery (4).

Do not connect the jumper cable to any part of the fuel system or to any moving parts. Avoid touching hot manifolds.

After the engine has started, first remove the negative (-) terminal jumper cable. Then remove the positive (+) terminal jumper cable.

**CAUTION:** Improper hook-up of jumper cables or use of other than 12-volt batteries could result in damage to equipment and/or the battery.

### WARNING!

- Never expose the battery to open flame or electric spark.
- Do not smoke near the battery.
- Batteries generate hydrogen gas which is flammable and explosive.
- Battery fluid contains sulfuric acid. Do not allow battery fluid to contact eyes, skin, fabrics or painted surfaces. If contact occurs, flush the affected area immediately with water. Obtain medical help immediately if eyes are affected.

Failure to follow the instructions for jump starting can lead to personal injury.

### PROPOSITION 65 WARNING!

Battery posts, terminals, and related accessories contain lead and lead compounds, chemicals known to the state of California to cause cancer and reproductive harm. Wash hands after handling.

**NOTE:** Refer to page 128 for information on properly maintaining the battery.

## Brake system

### ABS

#### Anti-lock Brake System (ABS)

If the warning lamp lights up there is a malfunction of the ABS system (the standard braking system will however function) and the vehicle should be driven cautiously to a Volvo retailer for inspection. The Anti-lock Braking System (ABS) helps to improve vehicle control (stopping and steering) during severe braking conditions by limiting brake lockup. When the system "senses" impending lockup, braking pressure is automatically modulated in order to help prevent lockup, which could lead to a skid.

**The system performs a self-diagnostic test when the vehicle first reaches a speed of approximately 12 mph (20 km/h).** The brake pedal will pulsate several times and a sound may be audible from the ABS control module. This is normal.

**To obtain optimal effect from the ABS system, constant pressure should be kept on the brake pedal while the system is modulating the brakes. Do not pump the brake pedal.**

The switching of the ABS modulator will be audible and the brake pedal will pulsate at this time. Please be aware that ABS does not increase the absolute braking potential of the vehicle. While control will be enhanced, ABS will not shorten stopping distances on slippery surfaces.

### BRAKE

#### Brake circuit malfunction

The brake system is a hydraulic system consisting of two master cylinders and two separate brake circuits. If a problem should occur in one of these circuits, it is still possible to stop the car with the other brake circuit.

If the brake pedal must be depressed farther than normal and requires greater foot pressure, the stopping distance will be longer.

A warning light in the instrument panel will light up to warn the driver that a fault has occurred.

If this light comes on while driving or braking, stop immediately and check the brake fluid level in the reservoir.

**NOTE:** Press the brake pedal hard and maintain pressure on the pedal – do **not** pump the brakes.

#### **WARNING!**

If the fluid level is below the MIN mark in either section of the reservoir: **DO NOT DRIVE.** Tow the car to a Volvo retailer and have the brake system checked and any leakage repaired.

#### Moisture on brake discs and brake pads affects braking

Driving in rain and slush or passing through an automatic car wash can cause water to collect on the brake discs and pads. This will cause a delay in braking effect when the pedal is depressed. To avoid such a delay when the brakes are needed, depress the pedal occasionally when driving through rain, slush etc. This will remove the water from the brakes. Check that brake application feels normal. This should also be done after washing or starting in very damp or cold weather.

#### Power brakes function only when the engine is running

The power brakes utilize vacuum pressure which is only created when the engine is running. Never let the vehicle roll to a stop with the engine switched off.

If the power brakes are not working, the brake pedal must be pressed approximately four times harder than usual to make up for the lack of power assistance. This can happen for example when towing your vehicle or if the engine is switched off when the vehicle is rolling. The brake pedal feels harder than usual.

### Severe strain on the brake system

The brakes will be subject to severe strain when driving in mountains or hilly areas or towing. Vehicle speed is usually slower, which means that the cooling of the brakes is less efficient than when driving on level roads. To reduce the strain on the brakes, shift into a lower gear and let the engine help with the braking. Do not forget that, if you are towing a trailer, the brakes will be subjected to a greater than normal load.

### EBD (Electronic Brake-force Distribution)

EBD is an integrated part of the ABS system. EBD regulates the hydraulic pressure to the rear brakes to help provide optimal braking capacity.

If the **BRAKE** and **ABS** warning lights come on at the same time, this could indicate a fault in the brake system. If the brake fluid level is above the MIN mark, drive carefully to an authorized Volvo retailer and have the brake system inspected.

#### **WARNING!**

If the fluid level is below the MIN mark in the reservoir, **DO NOT DRIVE**. Have the car towed to an authorized Volvo retailer and have the brake system inspected.

### Stability and Traction Control (STC)

The STC-system is designed to help reduce wheel spin by limiting power to the drive wheels if they begin to lose traction at speeds over 25 mph. At speeds over 25 mph, the STC system monitors and compares all four wheels. If one of the drive (front) wheels shows any tendency to slip, such as when driving on slippery roads, the difference in speed is immediately detected. This triggers a signal to the engine management system, which will reduce engine torque (by reducing fuel) until the differential is corrected. This torque reduction is handled in stages, and reaction time is extremely fast.

The  indicator light will **flash** when STC is actively regulating power to the drive wheels. Normal power may be reduced at this time. This is normal as power is momentarily reduced to help keep the drive wheels from losing traction and spinning.

**The STC indicator light  will come on:**

- When the car is started, for approximately **2 seconds**, as the system performs a self-diagnostic test.
- When STC has been switched off using the button on the dashboard.
- If the system is temporarily switched off due to high brake temperatures. STC will automatically restart when brake temperature has returned to normal.
- If a fault is detected in the system. Consult your Volvo retailer if this occurs.

## Towing a trailer

### When preparing for trailer towing, observe the following:

**NOTE:** Models with automatic transmission are equipped with a transmission oil cooler as standard equipment. This cooler helps prevent overheating of the transmission during times of increased load, as when towing a trailer.

Maximum trailer weight recommended by Volvo is:

- **Trailers without brakes:** 1100 lbs (500 kg)
- **Trailers with brakes:** 2" (50 mm) ball - 3300 lbs (1,500 kg), 1 7/8" (47 mm) ball - 2000 lbs (908 kg).

Observe the legal requirements of the state/province in which the vehicles are registered.

All Volvo models are equipped with energy-absorbing shock-mounted bumpers. Trailer hitch installation should not interfere with the proper operation of this bumper system.

Trailer towing does not normally present any particular problems, but take into consideration:

- Increase tire pressure to recommended full. See section "Wheels and tires".
- Recommended hitch tongue load is 110 lbs (50 kg) for trailer weights below 2,650 lbs (1,200 kg) and 165 lbs (75 kg) for trailer weights above 2,650 lbs (1,200 kg). For trailer weights between 2,650 - 3,300 lbs (1,200 - 1,500 kg) a top speed of 50 mph (80 km/h) should never be exceeded.

- Engine and transmission are subject to increased loads. Therefore, engine coolant temperature should be closely watched when driving in hot climates or hilly terrain. Use a lower gear and turn off the air conditioner if the temperature gauge pointer enters the red range.
- Avoid overload and other abusive operation.
- Hauling a trailer affects handling, durability, and economy.
- It is necessary to balance trailer brakes with the towing vehicle brakes to provide a safe stop (check and observe State/Local regulations).
- Do not connect the trailer's brake system directly to the vehicle's brake system.
- More frequent vehicle maintenance is required.
- Remove the ball and drawbar assembly when the hitch is not being used.
- Volvo recommends the use of synthetic engine oil when towing a trailer over long distances or in mountainous areas.

**NOTE:** Refer to section "Automatic transmission" for additional trailer hauling tips.

### WARNING!

- Bumper-attached trailer hitches must not be used on Volvos, nor should safety chains be attached to the bumper.
- Trailer hitches attaching to the vehicle rear axle must not be used.
- Never connect a trailer's hydraulic brake system directly to the vehicle brake system, nor a trailer's lighting system directly to the vehicle lighting system. Consult your nearest authorized Volvo retailer for correct installation.
- When towing a trailer, the trailer's safety wire must be correctly fastened to the hole or hook provided in the trailer hitch on the car. The safety wire should never be fastened to or wound around the drawbar ball.

### Cold weather precautions

If you wish to check your car before the approach of cold weather, the following advice is worth noting:

- Make sure that the **engine coolant** contains at least 50 percent antifreeze: that is, 3.7 qts. (3.5 liters) Volvo Genuine Coolant/Antifreeze. This gives protection against freezing down to -31°F (-35°C). See section "Coolant". **The use of "recycled" antifreeze is not approved by Volvo. Different types of antifreeze may not be mixed.**
- Try to keep the **fuel tank** well filled - this prevents the formation of condensation in the tank. In addition, in extremely cold weather conditions it is worthwhile to add fuel line de-icer before refueling.
- The viscosity of the engine oil is important. Oil with low viscosity (thinner oil) improves cold-weather starting as well as decreasing fuel consumption while the engine is warming up. For winter use, 5W-30 oil, particularly the synthetic type\*, is recommended. Be sure to use good quality oil but do not use this cold-weather oil for hard driving or in warm weather. **See section "Engine oil" for more information.**
- The load placed on the **battery** is greater during the winter since the windshield wipers, lighting, etc. are used more often. Moreover, the capacity of the battery decreases as the temperature drops. In very cold weather, a poorly charged battery can freeze and be damaged. It is therefore advisable to check the state of charge more frequently and spray an anti-rust oil on the battery posts.
- Volvo recommends the use of **snow tires** on all four wheels for winter driving - see section "Wheels and tires".
- To prevent the **washer fluid reservoir** from freezing, add washer solvents containing antifreeze (see page 125 for the location of the washer fluid reservoir). This is important since dirt is often splashed on the windshield during winter driving, requiring the frequent use of the washers and wipers. The Volvo Washer Solvent should be diluted as follows:

Down to 14° F (-10° C):	1 part washer solvent and 4 parts water
Down to 5° F (-15° C):	1 part washer solvent and 3 parts water
Down to 0° F (-18° C):	1 part washer solvent and 2 parts water
Down to -18° F (-28° C):	1 part washer solvent and 1 part water

- Use Volvo Teflon Lock Spray in the locks.

**NOTE:** Avoid the use of de-icing sprays as they can cause damage to the locks.

### W Winter/Wet mode

#### W Winter/Wet driving mode - Enhanced vehicle traction

- Mode W will only function if the gear selector is in the (D)rive position.
- Press the button at the base of the gear selector to engage/disengage this driving mode (see illustration).
- An LED in the button will light up to indicate that **W** is engaged and this will also be displayed in the instrument panel .
- This mode may be selected for starting/moving off on slippery roads.

\* Synthetic oil is not used when the oil is changed at the normal maintenance service intervals.





---

---

## Chapter 5 - Wheels and tires

General information	80
Tire inflation	81
Tire inflation pressure tables	83
Tire designations	84
Glossory of tire terminology	85
Vehicle loading	86
Uniform Tire Quality Grading	87
Snow chains, snow tires, studded tires	88
Temporary spare	89
Changing a wheel	90

## Wheels and tires

### General information

Your vehicle is equipped with tires according to the vehicle's tire information placard(s) on the rear edge of the driver's door (U.S. models), or on the rear edge of the passenger's door (Canadian models).

The tires have good road holding characteristics and offer good handling on dry and wet surfaces. It should be noted however that the tires have been developed to give these features on snow/ice-free surfaces.

Certain models are equipped with "all-season" tires, which provide a somewhat higher degree of road holding on slippery surfaces than tires without the "all-season" rating. However, for optimum road holding on icy or snow-covered roads, we recommend suitable winter tires on all four wheels.

When replacing tires, be sure that the new tires are the same size designation, type (radial) and preferably from the same manufacturer, on all four wheels. Otherwise there is a risk of altering the car's roadholding and handling characteristics.

**NOTE:** When storing wheel/tire assemblies (e.g. winter tires and wheels), either stand the assemblies upright, or suspend them off the ground. Laying wheel/tire assemblies on their sides for prolonged periods can cause wheel and/or tire damage.

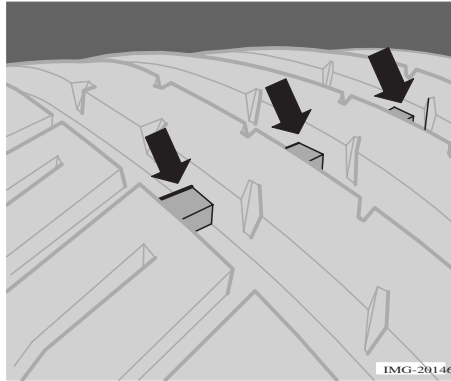

### Tread wear indicator

The tires have wear indicator strips running across or parallel to the tread. The letters TWI are printed on the side of the tire. When approximately 1/16" (1.6 mm) is left on the tread, these strips become visible and indicate that the tire should be replaced. Tires with less than 1/16" (1.6 mm) tread offer very poor traction.

When replacing worn tires, it is recommended that the tire be identical in type (radial) and size as the one being replaced. Using a tire of the same make (manufacturer) will prevent alteration of the driving characteristics of the vehicle.

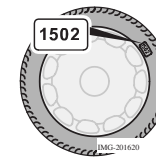

### New tires

Remember that tires are perishable goods. As of 2000, the manufacturing week and year will be indicated with 4 digits (e.g.

1502 means that the tire illustrated was manufactured during week 15 of 2002).

### Improving tire economy:

- Maintain correct tire pressure. See the tire pressure table on page 83.
- Drive smoothly: avoid fast starts, hard braking and tire screeching.
- Tire wear increases with speed.
- Correct front wheel alignment is very important.
- Unbalanced wheels impair tire economy and driving comfort.
- Tires must maintain the same direction of rotation throughout their lifetime.
- When replacing tires, the tires with the most tread should be mounted on the rear wheels to reduce the chance of oversteer during hard braking.

Hitting curbs or potholes can damage the tires and/or wheels permanently.

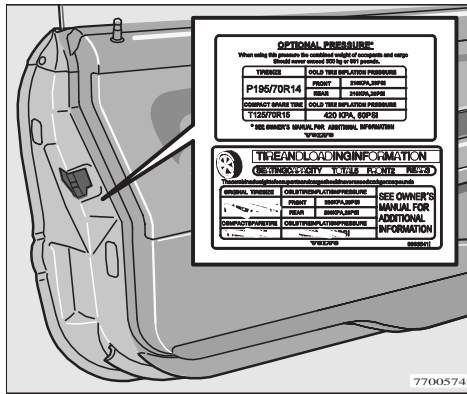

*Tire inflation placards on U.S. models*

### Tire inflation

Check tire inflation pressure regularly. A table listing the recommended inflation pressure for your vehicle can be found on page 83. Tire inflation pressure placards are also located on the rear edge of the driver's door (U.S. models), or on the rear edge of the passenger's door (Canadian models). These placards indicate the designation of the factory-mounted tires on your vehicle, as well as load limits and inflation pressure.

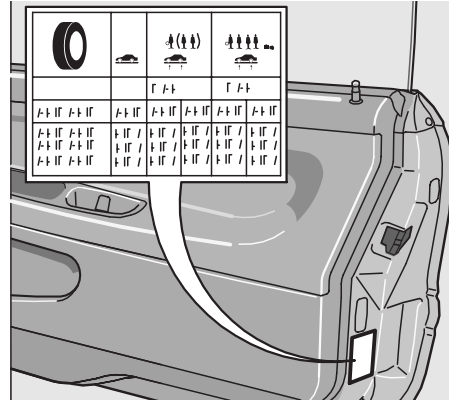

*Tire inflation placard on Canadian models*

**NOTE:** The placards shown only indicate inflation pressure for the tires installed on the car at the factory.

- Use a tire gauge to check the tire inflation pressure, including the spare, at least once a month and before long trips. You are strongly urged to buy a reliable tire pressure gauge, as automatic service station gauges may be inaccurate.
- Use the recommended cold inflation pressure for optimum tire performance and wear.
- Under-inflation or over-inflation may cause uneven treadwear patterns.

### WARNING!

- Under-inflation is the most common cause of tire failure and may result in severe tire cracking, tread separation, or “blowout,” with unexpected loss of vehicle control and increased risk of injury.
- Under-inflated tires reduce the load carrying capacity of your vehicle.

When weather temperature changes occur, tire inflation pressures also change. A 10-degree temperature drop causes a corresponding drop of 1 psi (7 kPa) in inflation pressure. Check your tire pressures frequently and adjust them to the proper pressure, which can be found on the vehicle's tire information placard or certification label.

### Checking tire pressure

#### Cold tires

Inflation pressure should be checked when the tires are cold.

**The tires are considered to be cold when they have the same temperature as the surrounding (ambient) air.**

This temperature is normally reached after the car has been parked for at least 3 hours.

After driving a distance of approximately 1 mile (1.6 km), the tires are considered to be hot. If you have to drive farther than this distance to pump your tire(s), check and record the tire pressure first and add the appropriate air pressure when you get to the pump.

## Wheels and tires

If checking tire pressure when the tire is hot, never “bleed” or reduce air pressure. The tires are hot from driving and it is normal for pressures to increase above recommended cold pressures. A hot tire at or below recommended cold inflation pressure could be significantly under-inflated.

### To check inflation pressure:

1. Remove the cap from the valve on one tire, then firmly press the tire gauge onto the valve.
2. Add air to reach the recommended air pressure
3. Replace the valve cap.
4. Repeat this procedure for each tire, including the spare.
5. Visually inspect the tires to make sure there are no nails or other objects embedded that could puncture the tire and cause an air leak.
6. Check the sidewalls to make sure there are no gouges, cuts, bulges or other irregularities.

### NOTE:

- If you overfill the tire, release air by pushing on the metal stem in the center of the valve. Then recheck the pressure with your tire gauge.
- Some spare tires require higher inflation pressure than the other tires. Consult the tire inflation table on page 83 or see the inflation pressure placard.

### Tire inflation pressure tables

Tire pressures recommended by Volvo for your vehicle. Refer to the tire inflation placard for information specific to the tires installed on your vehicle at the factory.

Tire size	Cold tire pressure for vehicle loads up to 735 lbs (335 kg) <sup>1</sup> psi (kPa)	
	Front, psi (kPa)	Rear, psi (kPa)
205/55R16	36 (250)	35 (240)
225/50R16		
225/45R17	36 (250)	36 (250)
Temporary spare tire T125/T125/80R17 T125/90R15	61 (420)	61 (420)

Optional tire pressure. These inflation pressures may only be used when the vehicle is not fully loaded.

Tire size	Optional cold tire pressure that may only be used for vehicle loads up to 495 lbs (225 kg) psi (kPa)	
	Front, psi (kPa)	Rear, psi (kPa)
205/55R16	33 (230)	30 (210)
225/50R16		
225/45R17		
Temporary spare tire T125/80R17 T125/90R15	61 (420)	61 (420)

<sup>1</sup> These weights include the weight of all occupants of the car plus cargo.

## Wheels and tires

### Tire designations

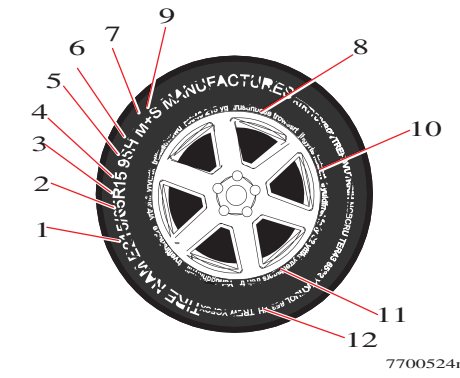

### Tire designations

Federal law mandates that tire manufacturers place standardized information on the sidewall of all tires (see the illustration).

The following information is listed on the tire sidewall:

The tire designation (the following figures are examples of a tire designation):

1. 215: the width of the tire (in millimeters) from sidewall edge to sidewall edge. The larger the number, the wider the tire.
2. 65: The ratio of the tire's height to its width.
3. R: Radial tire.
4. 15: The diameter of the wheel rim (in inches).

5. 95: The tire's load index. In this example, a load index of 95 equals a maximum load of 1521 lbs (690 kg).
6. H: The tire's speed rating, or the maximum speed at which the tire is designed to be driven for extended periods of time, carrying a permissible load for the vehicle, and with correct inflation pressure. For example, H indicates a speed rating of 130 mph (210 km/h).

**NOTE:** This information may not appear on the tire because it is not required by law.

7. M+S or M/S = Mud and Snow, AT = All Terrain, AS = All Season
8. U.S. DOT Tire Identification Number (TIN): This begins with the letters "DOT" and indicates that the tire meets all federal standards. The next two numbers or letters are the plant code where it was manufactured, the next two are the tire size code and the last four numbers represent the week and year the tire was built. For example, the numbers 317 mean the 31st week of 1997. After 2000 the numbers go to four digits. For example, 2501 means the 25th week of 2001. The numbers in between are marketing codes used at the manufacturer's discretion. This information helps a tire manufacturer identify a tire for safety recall purposes.

9. Tire Ply Composition and Material Used: Indicates the number of plies indicates or the number of layers of rubber-coated fabric in the tire tread and sidewall. Tire manufacturers also must indicate the ply materials in the tire and the sidewall, which include steel, nylon, polyester, and others.
10. Maximum Load: Indicates the maximum load in pounds and kilograms that can be carried by the tire. Refer to the vehicle's tire information placard located on the rear edge of the driver's door (U.S. models), or on the rear edge of the passenger's door (Canadian models), or the safety certification label, for the correct tire pressure for your vehicle.
11. Treadwear, Traction, and Temperature grades: See page 87 for more information.
12. Maximum permissible inflation pressure: the greatest amount of air pressure that should ever be put in the tire. This limit is set by the tire manufacturer.

### Glossary of tire terminology

The tire suppliers may have additional markings, notes or warnings such as standard load, radial tubeless, etc.

### Glossary of tire terminology

- **Tire information placard:** A placard showing the OE (Original Equipment) tire sizes, recommended inflation pressure, and the maximum weight the vehicle can carry.
- **Tire Identification Number (TIN):** A number on the sidewall of each tire providing information about the tire brand and manufacturing plant, tire size and date of manufacturer.
- **Inflation pressure:** A measure of the amount of air in a tire.
- **Standard load:** A class of P-metric or Metric tires designed to carry a maximum load at 35 psi [37 psi (2.5 bar) for Metric tires]. Increasing the inflation pressure beyond this pressure will not increase the tires load carrying capability.
- **Extra load:** A class of P-metric or Metric tires designed to carry a heavier maximum load at 41 psi [43 psi (2.9 bar) for Metric tires]. Increasing the inflation pressure beyond this pressure will not increase the tires load carrying capability.
- **kPa:** Kilopascal, a metric unit of air pressure.
- **PSI:** Pounds per square inch, a standard unit of air pressure.
- **B-pillar:** The structural member at the side of the vehicle behind the front door.
- **Bead area of the tire:** Area of the tire next to the rim.
- **Sidewall of the tire:** Area between the bead area and the tread.
- **Tread area of the tire:** Area of the perimeter of the tire that contacts the road when mounted on the vehicle.
- **Rim:** The metal support (wheel) for a tire or a tire and tube assembly upon which the tire beads are seated.
- **Maximum load rating:** a figure indicating the maximum load in pounds and kilograms that can be carried by the tire. This rating is established by the tire manufacturer.
- **Maximum permissible inflation pressure:** the greatest amount of air pressure that should ever be put in the tire. This limit is set by the tire manufacturer.
- **Recommended tire inflation pressure:** inflation pressure, established by Volvo, which is based on the type of tires that are mounted on a vehicle at the factory. This inflation pressure is affected by the number of occupants in the car, the amount of cargo, and the speed at which the vehicle will be driven for a prolonged period. This information can be found on the tire inflation placard(s) located on the rear edge of the driver's door (U.S. models), or on the rear edge of the passenger's door (Canadian models), and in the tire inflation table in this chapter.
- **Cold tires:** The tires are considered to be cold when they have the same temperature as the surrounding (ambient) air. This temperature is normally reached after the car has been parked for at least 3 hours.

## Wheels and tires

### Vehicle loading

Properly loading your vehicle will provide maximum return of vehicle design performance.

Before loading your vehicle, familiarize yourself with the following terms for determining your vehicle's weight ratings, with or without a trailer, from the vehicle's Federal/Canadian Motor Vehicle Safety Standards (FMVSS/CMVSS) label, and the vehicle's tire information placard:

#### Curb weight

The weight of the vehicle including a full tank of fuel and all standard equipment. It does not include passengers, cargo, or optional equipment.

#### Capacity weight

All weight added to the curb weight, including cargo and optional equipment. When towing, trailer hitch tongue load is also part of cargo weight.

**NOTE:** For trailer towing information, please refer to the section "Towing a trailer" on page 76.

#### Permissible axle weight

The maximum allowable weight that can be carried by a single axle (front or rear). These numbers are shown on the Federal/Canadian Motor Vehicle Safety Standards (FMVSS/CMVSS) label. The total load on each axle must never exceed its maximum permissible weight.

### Gross vehicle weight (GVW)

The vehicle's curb weight + cargo + passengers.

#### NOTE:

- The location of the various labels in your vehicle can be found on page 116.
- A table listing important weight limits for your vehicle can be found on page 137.

### Steps for Determining Correct Load Limit

(1) Locate the statement "the combined weight of occupants and cargo should never exceed XXX pounds" on your vehicle's placard.

(2) Determine the combined weight of the driver and passengers that will be riding in your vehicle.

(3) Subtract the combined weight of the driver and passengers from XXX kilograms or XXX pounds.

(4) The resulting figure equals the available amount of cargo and luggage load capacity. For example, if the "XXX" amount equals 1400 lbs. and there will be five 150 lb. passengers in your vehicle, the amount of available cargo and luggage load capacity is 650 lbs. (1400-750 (5 x 150) = 650 lbs.)

(5) Determine the combined weight of luggage and cargo being loaded on the vehicle. That weight may not safely exceed the available cargo and luggage load capacity calculated in Step 4.

(6) If your vehicle will be towing a trailer, load from your trailer will be transferred to your vehicle. Consult this manual<sup>1</sup> to determine how this reduces the available cargo and luggage load capacity of your vehicle.

#### WARNING!

- Exceeding the permissible axle weight, gross vehicle weight, or any other weight rating limits can cause tire overheating resulting in permanent deformation or catastrophic failure.
- Do not use replacement tires with lower load carrying capacities than the tires that were original equipment on the vehicle because this will lower the vehicle's GVW rating. Replacement tires with a higher limit than the originals do not increase the vehicle's GVW rating limitations.

<sup>1</sup> See "Towing a trailer" on page 76.



### Uniform Tire Quality Grading

#### **ALL PASSENGER VEHICLE TIRES MUST CONFORM TO FEDERAL SAFETY REQUIREMENTS IN ADDITION TO THESE GRADES**

Quality grades can be found, where applicable, on the tire sidewall between the tread shoulder and maximum section width. For example:

#### **Treadwear 200 Traction AA Temperature A TREADWEAR**

The treadwear grade is a comparative rating based on the wear rate of the tire when tested under controlled conditions on a specified government test course. For example, a tire graded 150 would wear one and one half (1 1/2) times as well on the government course as a tire graded 100. The relative performance of tires depends upon the actual conditions of their use, however, and many depart significantly from the norm due to variation in driving habits, maintenance practices and differences in road characteristics and climate.

#### **TRACTION**

The traction grades, from highest to lowest, are AA, A, B, and C, as measured under controlled conditions on specified government test surfaces of asphalt and concrete. A tire marked C may have poor traction performance. The traction grade assigned to this tire is based on braking (straight-ahead) traction tests and is not a measure of cornering (turning) traction.

#### **WARNING!**

The traction grade assigned to this tire is based on braking (straight-ahead) traction tests and is not a measure of cornering (turning) traction.

#### **TEMPERATURE**

The temperature grades are AA (the highest), A, B, and C, representing the tire's resistance to the generation of heat and its ability to dissipate heat when tested under controlled conditions on a specified indoor laboratory test wheel. Sustained high temperature can cause the material of the tire to degenerate and reduce tire life, and excessive temperature can lead to sudden tire failure. The grade C corresponds to a minimum level of performance that all passenger vehicle tires must meet under the Federal Motor Safety Standard No. 109. Grades B and A represent higher levels of performance on the laboratory test wheel than the minimum required by law.

#### **WARNING!**

The temperature grade for this tire is established for a tire that is properly inflated and not overloaded. Excessive speed, underinflation, or excessive loading, either separately or in combination, can cause heat buildup and tire failure.

## Wheels and tires

### Snow chains, snow tires, studded tires

#### Snow chains

Snow chains can be used on your Volvo with the following restrictions:

- Snow chains should be installed on front wheels only. Use only Volvo approved snow chains.
- If accessory, aftermarket or “custom” tires and wheels are installed and are of a size different than the original tires and wheels, chains in some cases CANNOT be used. Sufficient clearances between chains and brakes, suspension and body components must be maintained.
- Some strap-on type chains will interfere with brake components and therefore CANNOT be used.

Consult your Volvo retailer for additional snow chain information.

#### CAUTION!

- Check local regulations regarding the use of snow chains before installing.
- Always follow the chain manufacturer’s installation instructions carefully. Install chains as tightly as possible and retighten periodically.
- Never exceed the chain manufacturer’s specified maximum speed limit. (Under no circumstances should you exceed 31 mph (50 km/h)).
- Avoid bumps, holes or sharp turns when driving with snow chains.
- The handling of the vehicle can be adversely affected when driving with chains. Avoid fast or sharp turns as well as locked wheel braking.

#### Snow tires, studded tires<sup>1</sup>

##### Tires for winter use:

- Owners who live in or regularly commute through areas with sustained periods of snow or icy driving conditions are strongly advised to fit suitable winter tires to help retain the highest degree of traction.
- It is important to install winter tires on all four wheels to help retain traction during cornering, braking, and accelerating. Failure to do so could reduce traction to an unsafe level or adversely affect handling.

- Do not mix tires of different design as this could also negatively affect overall tire road grip.
- Winter tires wear more quickly on dry roads in warm weather. They should be removed when the winter driving season has ended.
- Studded tires should be run-in 300-600 miles (500-1000 km) during which the car should be driven as smoothly as possible to give the studs the opportunity to seat properly in the tires. The tires should have the same rotational direction throughout their entire lifetime.

**NOTE:** Please consult state or provincial regulations restricting the use of studded winter tires before installing such tires.

<sup>1</sup> Where permitted

### Temporary Spare

The spare tire in your car is called a “Temporary Spare”.

Recommended tire pressure (see the tire inflation placard(s) on the rear edge of the driver’s door (U.S. models), or on the rear edge of the passenger’s door (Canadian models)) should be maintained irrespective of which position on the car the temporary spare tire is used on.

In the event of damage to this tire, a new one can be purchased from your Volvo retailer.

#### **WARNING!**

Current legislation prohibits the use of the “Temporary Spare” tire other than as a temporary replacement for a punctured tire. It must be replaced as soon as possible by a standard tire. Road holding and handling may be affected with the “Temporary Spare” in use. Do not exceed 50 mph (80 km/h). Do not drive farther than 50 miles (80 km) on a temporary spare tire.

#### **CAUTION!**

The car must not be driven with wheels of different dimensions or with a spare tire other than the one that came with the car. The use of different size wheels can seriously damage your car’s transmission.

## Wheels and tires

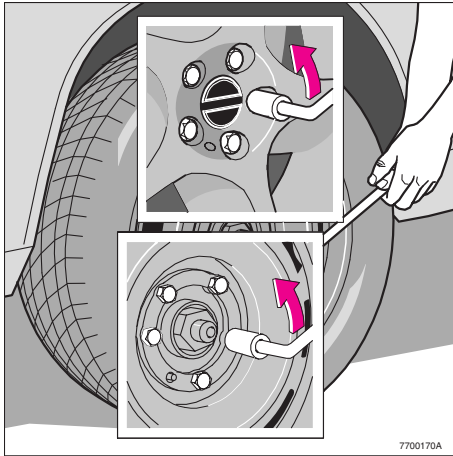

*Loosen wheel bolts*

### Changing a wheel

The spare wheel is located under the carpet on the trunk floor. The jack and crank are secured in the wheel recess.

- Engage the parking brake.
- Put the gear selector in (P)ark (automatic) or in Reverse (manual).
- With the car still on the ground, use the lug wrench to loosen the wheel bolts 1/2 - 1 turn. Turn the bolts counterclockwise to loosen.
- Fold out the crank handle on the jack by pressing the knob on the handle downward. To attach the jack, refer to the illustration on the following page.

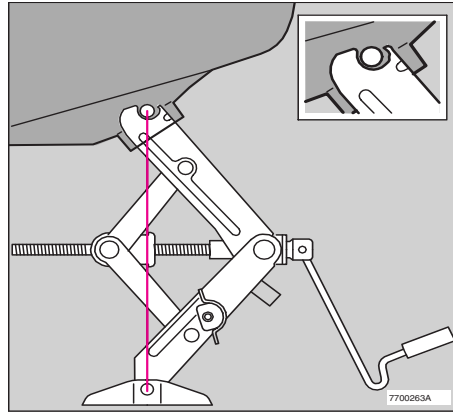

*Jack attachment*

There is a jack attachment located in the center on each side of the car. Position the jack on the bar in the attachment as shown in illustration above and crank while simultaneously guiding the base of the jack to the ground. **The base of the jack must be flat on a level, firm, non-slippery surface. Before raising the car, check that the jack is still correctly positioned in the attachment.**

#### **WARNING!**

The jack's attachment must engage the bar in the jack attachment (see inset illustration above). The car's weight must not rest on the jack attachment.

Raise the vehicle until both wheels on the side of the car where the jack is attached are lifted off the ground. Unscrew the wheel bolts completely and carefully remove the wheel so as not to damage the thread on the studs.

**NOTE:** To avoid excessive wear and the necessity of rebalancing, mark and reinstall wheels in the same location and position as before removal. To lessen the chance of imbalance, each wheel hub is equipped with a guide stud to ensure that a removed wheel can be reinstalled in its original position (as when changing over to winter tires/wheels).

**CAUTION:** The car must not be driven with wheels of different dimensions or with a spare tire other than the one that came with the car. The use of different size wheels can seriously damage your car's transmission.

### WARNING!

- The jack's attachment must engage the bar in the jack attachment (see inset illustration in center column on the previous page). The car's weight must not rest on the jack attachment.
- Be sure the jack is on a firm, level, non-slippery surface.
- Never allow any part of your body to be extended under a car supported by a jack.
- Use the jack intended for the car when replacing a wheel. For any other job, use stands to support the side of the car being worked on.
- Apply the parking brake, select position P (automatic transmission) or Reverse gear (manual transmission).
- Block the wheels standing on the ground, use rigid wooden blocks or large stones.
- The jack should be kept well-greased.

### Installing the wheel

Clean the contact surfaces on the wheel and hub. Lift the wheel and place it on the hub. Make sure that you align the wheel with the guide stud on the wheel hub prior to installation. Install the wheel bolts crosswise (see illustration) and tighten by turning lightly clockwise. Lower the vehicle to the ground and alternately tighten the bolts to 100 ft. lbs. (136 Nm). Install the wheel cap (where applicable).

**CAUTION:** Correct tightening torque on wheel bolts must be observed. The wheel bolts should never be greased or lubricated. The extended, chromed wheel bolts must not be used with steel rims, as they make it impossible to fit the hub caps.

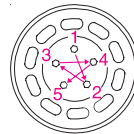

*Correct tightening order for wheel bolts*



---

---

## Chapter 6 - In case of an emergency

Replacing bulbs	94
Replacing fuses	100
Installation of accessories	103
Replacing wiper blades	104
In case of emergency	106

## Replacing bulbs

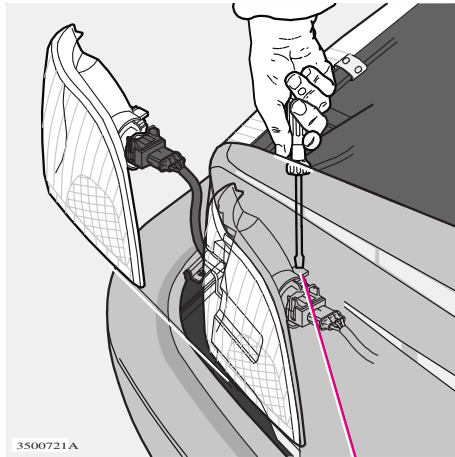

Catch

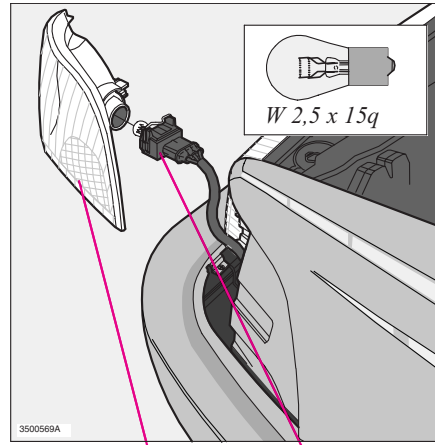

Lamp housing    Bulb holder  
Bulb- 3357NA, 30/7W/30/2.2cp

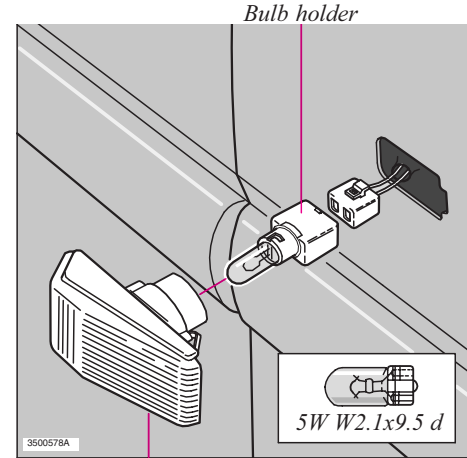

### Parking light/direction indicator

1. From the front of the car, use a screwdriver to press down on the silver catch (located in the space between the inside of the fender and the headlight unit) to release the lamp housing from the front fender.
2. Turn the bulb holder 1/4 turn clockwise (viewed from the front) and withdraw it from the lamp housing. Leave the connector with its wires in the bulb holder.
4. Remove the bulb from the holder by pulling it straight out.
5. Press a new bulb into the holder and reinstall the unit in the reverse order.

### Side direction indicator

1. Slide the lens forward and pull out the rear edge.
2. Pull out the entire lens/bulb unit.
3. With the lens toward you, turn the bulb holder 1/4 turn (the wires should not be disconnected from the holder) and pull out the bulb holder from the lens unit.
4. Pull the old bulb straight out and press a new one into place.
5. Replace the entire unit in the reverse order.



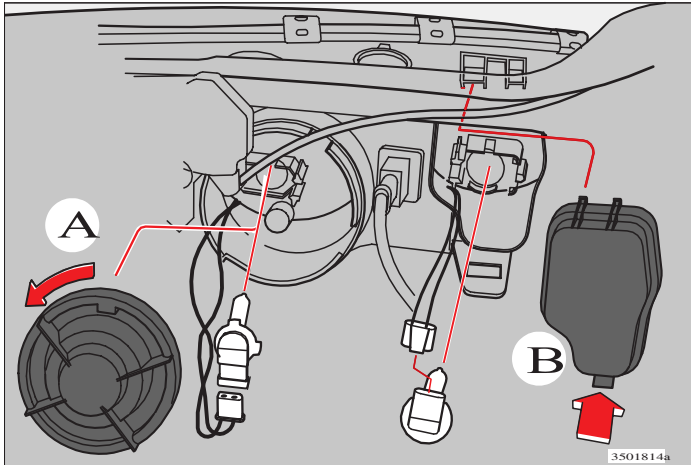

A - Low beam (H11 bulb)

B - High beam (HB3 bulb)

### Low beam headlight bulb (A) replacement

1. Turn the plastic cover counterclockwise and remove it.
2. Turn the bulb assembly slightly counterclockwise to release it from the headlight housing. The bulb and holder are one unit.
3. Pull out the bulb unit.
4. Pry loose the wiring connector from the bulb unit. It may be necessary to use a small screwdriver.
4. Connect the wiring connector to the new bulb unit.
5. Reinsert the bulb and connector into the headlight housing.
6. Turn the bulb unit clockwise until it seats properly in the headlight housing.
9. Reinstall the plastic cover and turn it clockwise until it is securely in place.

### High beam headlight bulb (B) replacement

1. Pull the catch on the lower edge of the cover upward and remove the plastic cover.
2. Turn the bulb assembly slightly counterclockwise to release it from the headlight housing. The bulb and holder are one unit.
3. Pull out the bulb unit.
4. Pry loose the wiring connector from the bulb unit. It may be necessary to use a small screwdriver.
4. Connect the wiring connector to the new bulb unit.
5. Reinsert the bulb and connector into the headlight housing.
6. Turn the bulb unit clockwise until it seats properly in the headlight housing.
6. Reinstall the plastic cover. The catch should snap into position.

#### CAUTION:

- Do not touch the glass on halogen bulbs with your fingers. Grease, oil, or any other impurities can be carbonized onto the bulb and cause damage to the reflector.
- Be sure to use bulbs of the correct type and voltage.

## Replacing bulbs

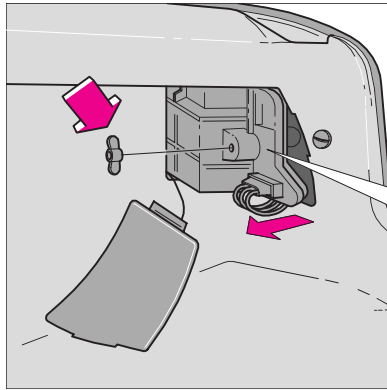

Lamp location- right side

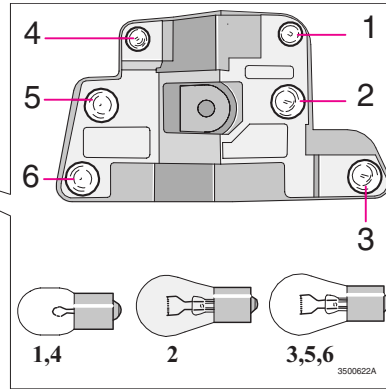

Location of bulbs in holders (left side, seen from inside the trunk)

Bulbs 1,4:  
5W/4 cp BA 15 s

Bulb 2:  
21W BAU 15 (amber)

Bulbs 3,5,6:  
21W/32 cp BA 15 s

### Tail light bulbs

1. Tail light
2. Direction indicator
3. Brake light
4. Tail light
5. Back-up light
6. Rear fog light (left side only)

**All the bulbs in the tail light unit are replaced from inside the trunk as follows:**

1. Turn the plastic screw and remove the cover over the rear lamp unit.
2. Remove the wing nut and remove the bulb holder.

3. Let the connector with its wires remain attached to the bulb holder.
4. Remove the bulb by pressing in and turning counterclockwise.
5. Insert a new bulb into the holder and reinstall the holder into the tail light assembly.
6. Close the cover.

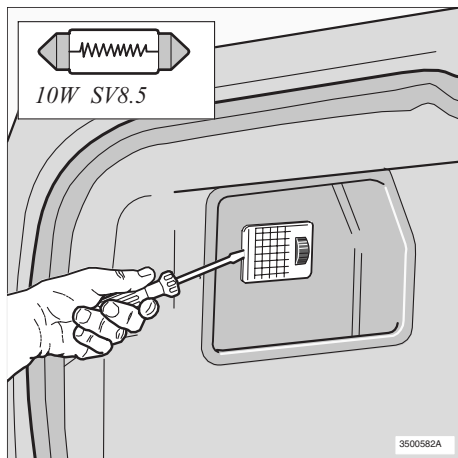

*Insert screwdriver and turn*

### Trunk light

1. Switch off the lights.
2. Press in the catch with a screwdriver and remove the bulb holder.
3. Replace the bulb and reinstall the bulb holder.

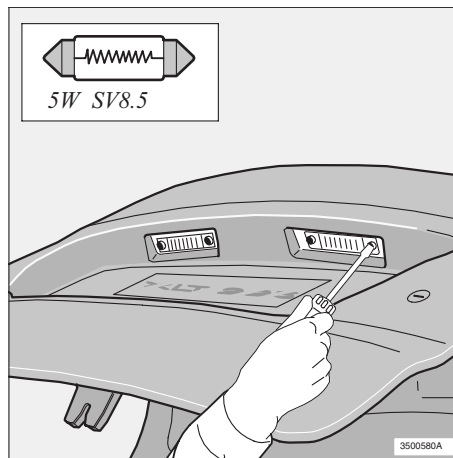

### License plate lights

1. Switch off the lights.
2. Unscrew the screw.
3. Insert the screwdriver and turn gently to loosen the glass lens.
4. Replace the bulb and reinstall the glass lens.

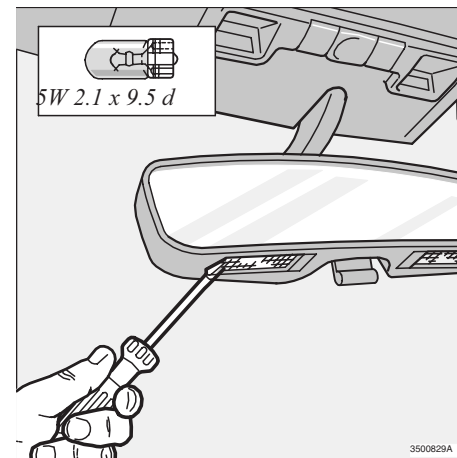

*Insert screwdriver and turn*

### Front courtesy lights

1. Switch off the ignition.
2. Insert a screwdriver and turn carefully to loosen the glass lens.
3. Replace the bulb and press the glass lens back into place.

## Replacing bulbs

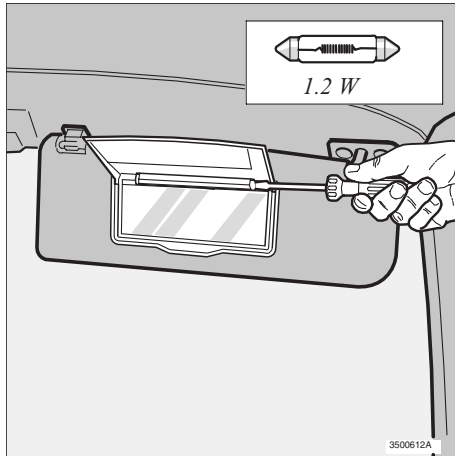

*Insert a screwdriver and turn*

### Vanity mirror

1. Switch off the ignition.
2. Insert a screwdriver under the lower edge and turn to loosen the glass lens.
3. Push out the bulb and replace it.
4. Press the lower edge of the lens into place above the four catches.
5. Press the upper edge of the lens into place.

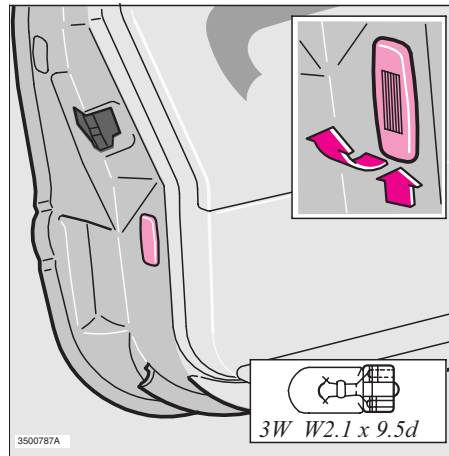

*Slide upward and pull out lower edge*

### Door warning lights

1. Slide the lamp unit upward and pull out the lower edge.
2. Twist off the bulb holder.
3. Pull the bulb straight out.
4. Replace the bulb.
5. Reinstall the holder and lamp unit in reverse order.

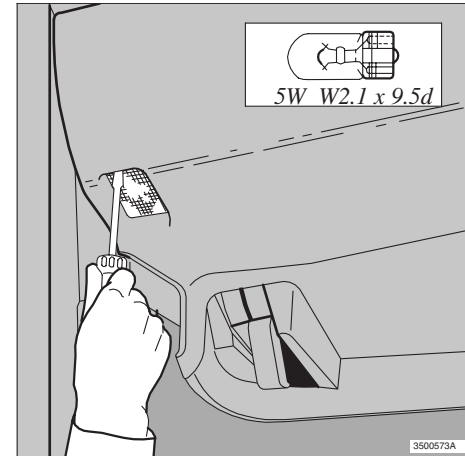

*Insert a screwdriver*

### Door step courtesy lights

1. Insert a screwdriver and pry out the glass lens.
2. Withdraw the lamp unit, bend back the tabs and remove the plate.
3. Replace the bulb.
4. Reinstall the plate.
5. Press the lamp unit back into place.

**NOTE:** Other bulbs may be difficult for the owner to replace. Let your Volvo retailer replace these bulbs if necessary.

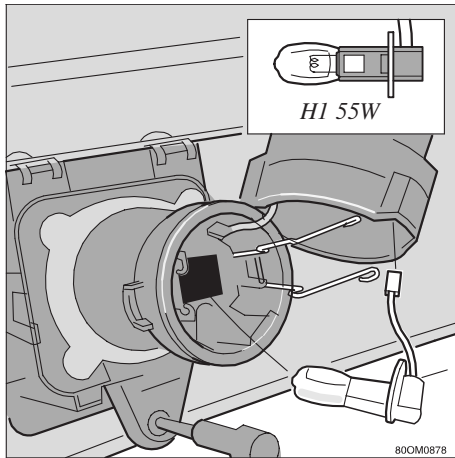

*Front fog lights in spoiler*

### **Front fog lights**

1. Switch off the lights
2. Turn the plastic cover counterclockwise to remove it.
3. Press the spring toward the lamp unit to release it and move it to the side.
4. Replace the bulb.
5. Reinstall in reverse order.

## Replacing fuses

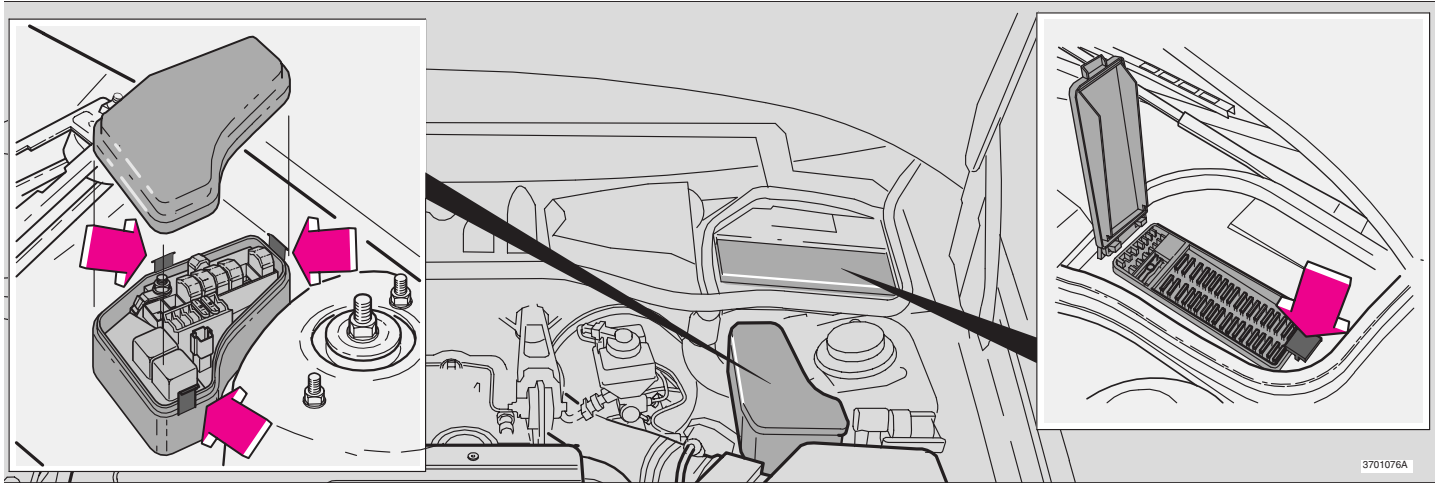

Relay/Main fuse box

Supplementary fuse box

### Replacing fuses

If an electrical component fails to function, it is likely that a fuse has blown due to a temporary circuit overload.

The fuse boxes are located in the engine compartment (see illustration) and can be opened by pressing the catches and lifting the cover (Relay/Main fuse box) or by lifting the cover (supplementary fuse box).

A label on the inside of each cover indicates the amperage and the electrical components that are connected to each fuse.

The easiest way to see if a fuse is blown is to remove it \*. Pull the fuse straight out. From the side, examine the curved metal wire to see if it is broken. If so, put in a new fuse of the same color and amperage (written on the fuse). Spare fuses are stored in a compartment in the Supplementary fuse box. If fuses burn out repeatedly, have the electrical system tested at a Volvo retailer. If you find it difficult to remove a fuse, you will find a special fuse tool clipped in the fuse box.

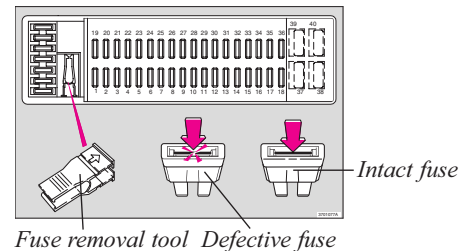

Fuse removal tool Defective fuse

Intact fuse

### WARNING!

Never use fuses with higher amperage than those stated on the following pages. Doing so could overload the car's electrical system.

\* Fuses in the Relay/Main fuse box should only be changed by an authorized Volvo service technician.

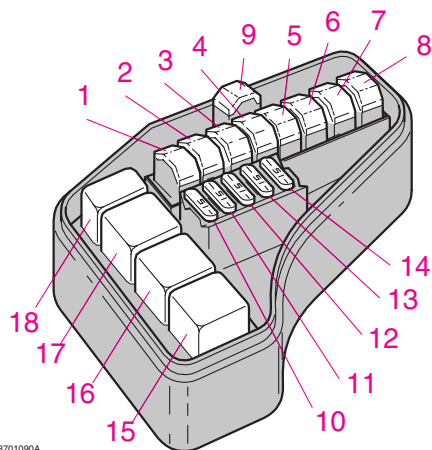

3701090A

## Relay/Main fuse box

Fuses in the main fuse box protect the entire electrical system. If one of the fuses blows, there is a serious electrical fault. Do not change any of these fuses. Contact your nearest Volvo workshop for a closer analysis.

## Relays

- 15 System relay
- 16 -
- 17 Starter motor
- 18 Air conditioning

## Fuses in Relay/Main fuse box (main system fuses)

Location *	Amperage
1 Electric cooling fan .....	60A
2 Fuses in Supplementary fuse box .....	50A
3 Starter motor .....	50A
4 ABS, STC .....	50A
5 Headlights .....	50A
6 Fuses in Supplementary fuse box .....	60A
7 Fuses in Supplementary fuse box .....	50A
8 Control modules - engine/automatic transmission .....	60A
9 Electrically operated windows left/right .....	60A
10 Ignition switch, Control modules - engine/automatic transmission .....	10A
11 A/C relay, fuel system .....	15A
12 Fuel pump, fuel injectors, engine control module .....	15A
13 Ignition system .....	15A
14 Emission system .....	20A

\* Some of the equipment/systems listed may be available on certain models only.

## Fuses (supplementary fuse box)

Location *	Amperage	Location *	Amperage
1 Trunk open switch solenoid .....	10A	25 -	
2 Rear fog light, trailer connections .....	10A	26 Headlight switch .....	15A
3 Central locking system .....	10A	27 Backup lights, turn signals .....	15A
4 Immobilizer, ABS, shiftlock .....	10A	28 Heated front seats (certain models) .....	25A
5 Climate systems, Onboard diagnostics OBDII .....	15A	29 Heated rear window, shiftlock, seat belt reminder, cruise control, heated door mirrors, bulb failure warning sensor, accessories, convertible top .....	10A
6 Central locking system .....	20A	30 12-volt auxiliary socket .....	15A
7 Audio system .....	20A	31 Passenger compartment blower-climate systems .....	25A
8 Immobilizer, trip computer, headlight switch .....	15A	32 Audio system, ECC, convertible top, trunk lid cutoff, instrument lighting .....	10A
9 Amplifier - audio system .....	30A	33 -	
10 Remote keyless entry system .....	10A	34 Windshield wipers/washers, horn .....	25A
11 Brake lights .....	10A	35 Accessories, convertible top, drivers vanity mirror light, courtesy lighting, auto-dim mirror function (option) .....	10A
12 Audio system .....	30A	36 SRS-airbag .....	15A
13 Hazard warning flashers, headlight flashers, central locking system, turn signals .....	15A	37 Power windows, power mirrors .....	AUT/CB**
14 Heated rear window and door mirrors .....	40A	38 -	
15 Courtesy lights, door open warning lights, trunk, seat belt reminder, glove compartment light, power windows .....	10A	39 Power seat (driver's side) .....	AUT/CB**
16 Power antenna, electrical connector for trailer, accessories, CD- changer (option) .....	30A	40 Power seat (passenger's side) .....	AUT/CB**
17 Front fog lights .....	20A	41 Power seat (driver's side) .....	AUT/CB***
18 Key reminder, headlight relay .....	10A	42 Power seat (passenger's side) .....	AUT/CB***
19 Left high beam, accessories .....	15A		
20 Right high beam, high beam indicator light .....	15A		
21 Left low beam .....	15A		
22 Right low beam .....	15A		
23 Left front/rear parking lights, left tail light, license plate lights, trailer connections .....	10A		
24 Right front/rear parking lights, right tail light, license plate lights, trailer connections .....	10A		

\* Some of the equipment/systems listed may be available on certain models only.

\*\* This is an automatic circuit breaker located in the fuse box and does not normally need to be replaced.

\*\*\* These circuit breakers are located in the central electrical unit.



## Installation of accessories

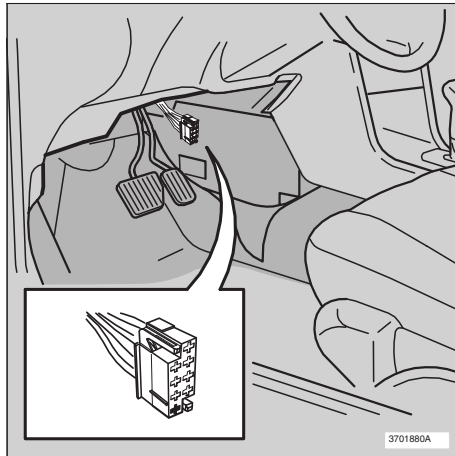

### Connector (for accessories)

Position	Connection	Max. load
1	Battery +(30)	20 A
2	X Supply	0,5 A
3	High beam	1 A
4	-	-
5	-	-
6	Rheostat	0,5 A
7	-	-
8	Ground (31)	-

### Installation of accessories

In order to help avoid interference and damage to your car's electrical system, the car is equipped with an accessory connector located under the instrument panel on the driver's side.

Please consult your Volvo retailer if you have any questions before connecting accessory or optional equipment to the vehicle's electrical system.

## Replacing wiper blades

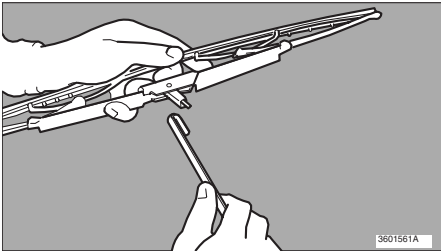
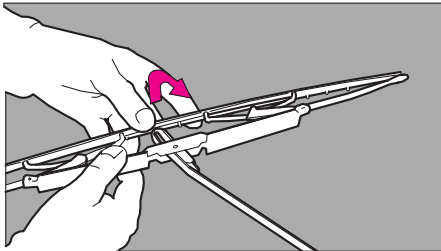
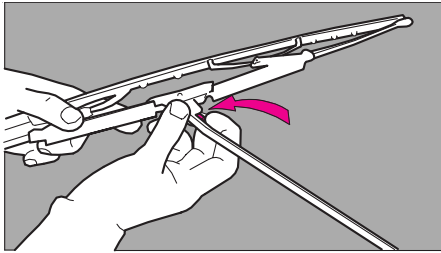

### Replacing wiper blades

Lift the wiper arm off the windshield and hold the blade at right angles to the arm. Pinch the end of the plastic clip located at the back of the arm.

Slide the wiper blade along the arm to release it from the hook.

Install the new blade (installation is the reverse of removal) and make sure that it is properly attached to the wiper arm.

**NOTE:** For reasons of safety, you should change the windshield wiper blades as soon as they start to leave marks on the windshield or fail to wipe efficiently and cleanly.

To obtain maximum lifetime from a set of wiper blades, clean them with a stiff-bristle brush and warm, soapy water as part of a normal car wash.

### Cleaning the outside of the windshield and wiper blades

If the windshield is not clear after using the wiper(s) or if the blade chatters when running, wax or other material may be on the blade or on the surface of the glass.

Clean the glass with a suitable cleaning agent. The glass is clean if beads do not form when you rinse it with water.

Clean the wiper blade by wiping vigorously with a cloth soaked in full strength windshield washer solvent. Then rinse the blade with water.

Wiper blades should be checked on a regular basis and replaced when worn.

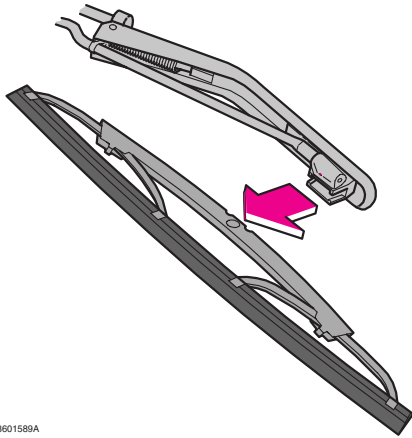

3601589A

### Replacing headlight wiper blades

Pull the wiper blade in the direction indicated by the arrow in the illustration to remove it. Press the new wiper blade into place. Check that the new blade is properly attached to the wiper arm.

## In case of emergency



### Shiftlock release (automatic transmission only)

The gear selector is locked in the (P)ark position. To manually release the shiftlock:

1. Turn the starting (ignition) key to position I
2. Press firmly on the “SHIFTLOCK OVERRIDE” button located to the right of the base of the gear selector
3. While holding the override button down, press the button on the front of the gear selector
4. Move the selector from the (P)ark position.

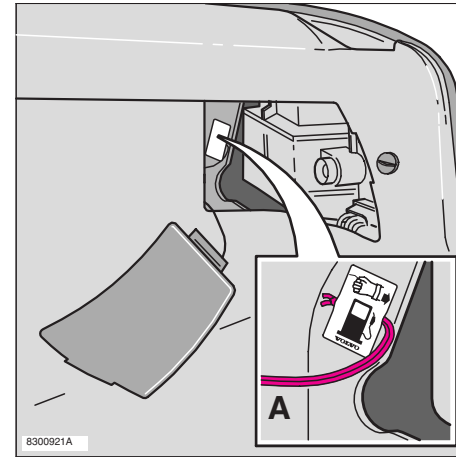

### Manually opening the fuel filler door

The fuel tank filler door can be opened manually by removing the cover over the right tail light housing and pulling the cord (A) until the fuel tank cover pops open.

## In case of emergency

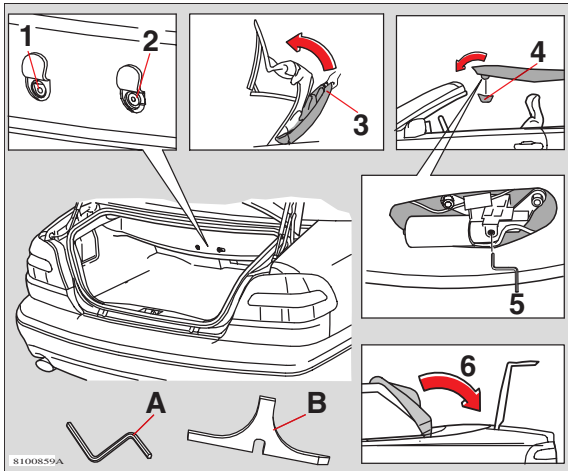

### Manually raising the convertible top

**NOTE:** The tools needed (A and B in the illustration) are located in the glove compartment.

- 1. Open the trunk. The trunk must be open during the entire procedure.**
- 2. Open the cover over the convertible top storage space**
  - Insert tool B in the right-hand hole (2) and turn it counterclockwise one complete turn and then turn it clockwise 1/4 turn and remove it.
  - Insert tool A in the left-hand hole (1) and turn it counterclockwise (80-85 full turns) until the cover over the convertible top storage compartment is completely open.
- 3. Pull the convertible top forward**
  - Pull the convertible top up out of the storage compartment by grasping the **lower\*** rear brace (3). Pull the convertible top forward to the upper edge of the windshield.

- Remove the cover (4) at the front inside edge of the convertible top by pulling it straight down. Pull the convertible top down onto the upper edge of the windshield. Insert tool A as shown in the inset illustration (5) and turn it clockwise 60-65 full turns until the convertible top seals properly with the upper edge of the windshield.

#### 4. Close the cover over the convertible top storage compartment

- Insert tool A in the left-hand hole (1) and turn it clockwise (80-85 full turns) until the cover over the convertible top storage compartment no longer moves. *The cover is not completely closed at this point.*
- Insert tool B in the right-hand hole (2) and turn it clockwise one complete turn and then turn it counterclockwise 1/4 turn and remove it. The cover is now locked in place.

#### 5. Fold the rear window down

- Fold the rear window down and press it toward the attachment. Insert tool A in the left-hand hole (1) and turn it clockwise until the rear window is correctly in place.

**NOTE:** After manually raising the convertible top, the car should be inspected by an authorized Volvo retailer.

### Circuit breaker

If the automatic circuit breakers have activated, wait at least 20 seconds before attempting to raise the top again using the switch on the instrument panel.

#### CAUTION:

- Do not attempt to service the convertible top motors, sensors or any moving parts yourself. This should only be done by an authorized Volvo retailer.

\* If the lower rear brace is not used to pull up the convertible top, the entire mechanism may be damaged.



---

---

## Chapter 7 - Car care

Paint touch-up	110
Washing	112
Automatic car washing, Polishing and waxing	113
Cleaning the upholstery	114

## Paint touch up

### Paint touch-up

Paint damage requires immediate attention to avoid rusting. Make it a habit to check the finish regularly - when washing the car for instance. Touch-up if necessary.

Paint repairs require special equipment and skill. Contact your Volvo retailer for any extensive damage.

Minor scratches can be repaired by using Volvo touch-up paint.

**NOTE:** When ordering touch-up paint from your Volvo retailer, use the paint code indicated on the model plate. The plate is located in the engine compartment, on the inside of the left front fender.

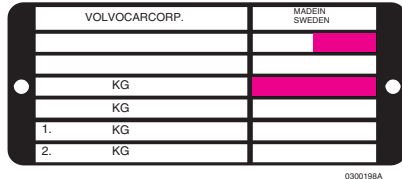

0000198A

### Minor stone chips and scratches

Material:

Primer - can

Paint - touch-up bottle

Brush

Masking tape

**NOTE:** When touching up the car, it should be clean and dry. The surface temperature should be above 60° F (15° C).

### Scratches on the surface

If the stone chip has not penetrated down to the metal and an undamaged layer of paint remains, the touch-up paint can be applied as soon as the spot has been cleaned.



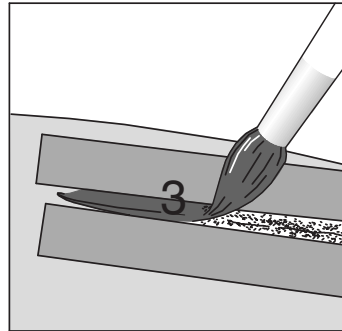
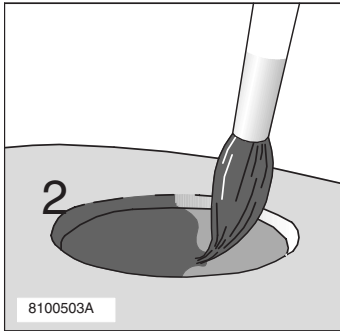
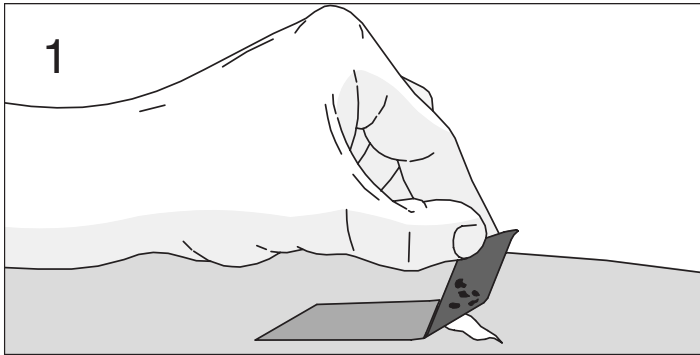

### Deep scratches

1. Place a strip of masking tape over the damaged surface. Pull the tape off so that any loose flakes of paint adhere to it.
2. Thoroughly mix the primer and apply it with a small brush. When the primer surface is dry, the paint can be applied using a brush. Mix the paint thoroughly; apply several thin paint coats and let dry after each application.
3. If there is a longer scratch, you may want to protect surrounding paint by masking it off.

## Washing

### Washing the car

- The car should be washed at regular intervals since dirt, dust, insects and tar spots adhere to the paint and may cause damage.

**NOTE:** It is particularly important to wash the car frequently in the wintertime to prevent corrosion, when salt has been used on the roads.

- When washing the car, do not expose it to direct sunlight. Use lukewarm water to soften the dirt before you wash with a sponge, and plenty of water, to avoid scratching.
- **Bird droppings:** Remove from paintwork as soon as possible. Otherwise the finish may be permanently damaged.
- A detergent can be used to facilitate the softening of dirt and oil.
- A water-soluble grease solvent may be used in cases of sticky dirt. However, use a wash place equipped with a drainage separator.
- Dry the car with a clean chamois and remember to clean the drain holes in the doors and rocker panels \*.
- The power radio antenna must be dried after washing.
- Tar spots can be removed with kerosene or tar remover after the car has been washed.
- A stiff-bristle brush and lukewarm soapy water can be used to clean the wiper blades. Frequent cleaning improves visibility considerably.
- Wash off the dirt from the underside (wheel housings, fenders, etc.).
- In areas of high industrial fallout, more frequent washing is recommended.

**CAUTION:** During high pressure washing, the spray mouthpiece must never be closer to the vehicle than 13" (30 cm). Do not spray into the locks.

- When washing or steam cleaning the engine, avoid spraying water or steam directly on the electrical components or toward the rear side of the engine.
- After cleaning the engine, the spark plug wells should be inspected for water and blown dry if necessary.

### Suitable detergents

Special car washing detergents should be used. A suitable mixture is about 2.5 fl. oz. (8.5 cl) of detergent to 2.6 US gal. (10 liters) of warm water. After washing with a detergent the car should be well rinsed with clean water.

#### WARNING!

- When the car is driven immediately after being washed, apply the brakes several times in order to remove any moisture from the brake linings.
- Engine cleaning agents should not be used when the engine is warm. This constitutes a fire risk.

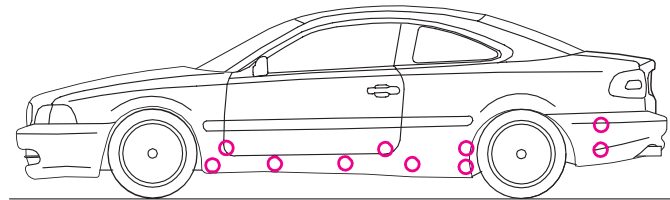

8100512A

Volvo offers an environmentally friendly Car Care Kit, containing waxing, washing, and degreasing agents.

**NOTE:** When washing the car, remember to remove dirt from the drain holes in the doors and sills. Bumpers: Wash the bumpers with the same cleaning agent used on the rest of the car. Never clean the bumpers with gasoline or paint thinner. Difficult spots can be removed with denatured alcohol. To avoid scratches, do not dry the bumpers with paper.

\* Pay special attention to the drain holes near the base of the windshield in the cowl under the rear edge of the hood.

## Automatic car washing, Polishing and waxing

### Automatic washing - simple and quick

An automatic wash is a simple and quick way to clean your car, but it is worth remembering that it may not be as thorough as when you yourself go over the car with sponge and water. Keeping the underbody clean is most important, especially in the winter. Some automatic washers do not have facilities for washing the underbody.

Before driving into an automatic wash, make sure that side view mirrors, auxiliary lamps, etc., are secure, otherwise there is risk of the machine dislodging them. **You should also lower the antenna by turning off the radio.**

**We do NOT recommend washing your car in an automatic wash during the first six months (because the paint will not have hardened sufficiently).**

### Cleaning the convertible top

#### CAUTION:

**Some automatic car washes can damage the convertible top. For this reason, we recommend washing the car by hand only.**

Remember that the windows are lowered slightly when the convertible top is raised. Be sure the windows are closed and the convertible top is completely raised and properly in place at the upper edge of the windshield before washing the car. A chime indicates when the top has been fully raised (see page 40).

- Wash the convertible top with a mild detergent, wiping from the front towards the rear. Rinse thoroughly with clean water.
- Do not wash the convertible top with a high pressure spray.
- After washing, the convertible top should be completely dry before it is folded down.
- Remove bird droppings from the convertible top as soon as possible. Otherwise the top may be permanently stained.
- A soft brush can be used to clean the convertible top between washings.

- Winter: remove any residue of road salt from the convertible top as soon as possible.
- Do not use solvents, tar remover or other all-purpose stain removers to clean the convertible top. Use Volvo approved cleaning agents only - consult your Volvo retailer.

### Polishing and waxing

- Normally, polishing is not required during the first year after delivery, however, waxing may be beneficial.
- Before applying polish or wax the car must be washed and dried. Tar spots can be removed with kerosene or tar remover. Difficult spots may require a fine rubbing compound.
- After polishing use liquid or paste wax.
- Several commercially available products contain both polish and wax.
- Waxing alone does not substitute for polishing of a dull surface.
- A wide range of polymer-based car waxes can be purchased today. These waxes are easy to use and produce a long-lasting, high-gloss finish that protects the bodywork against oxidation, road dirt and fading.

#### CAUTION:

Volvo does not recommend the use of long-life or durable paint protection coatings, some of which may claim to prevent pitting, fading, oxidation, etc. These coatings have not been tested by Volvo for compatibility with your vehicle's clear coat. Some of them may cause the clear coat to soften, crack, or cloud. Damage caused by application of paint protection coatings may not be covered under your vehicle's paint warranty.

## Cleaning the upholstery

### Fabric

Clean with soapy water or a detergent. For more difficult spots caused by oil, ice cream, shoe polish, grease, etc., use a clothing/fabric stain remover.

### Plastic

The plastic in the upholstery can be cleaned with a soft cloth and mild soap solution.

### Alcantara™ suede-like material

Suede-like upholstery can be cleaned with a soft cloth and mild soap solution.

### Leather care

Volvo's leather upholstery is manufactured with a protectant to repel soiling. Over time, sunlight, grease and dirt can break down the protection. Staining, cracking, scuffing, and fading can result.

Volvo offers an easy-to-use, non-greasy leather care kit formulated to clean and beautify your vehicle's leather, and to renew the protective qualities of its finish. The cleaner removes dirt and oil buildup. The light cream protectant restores a barrier against soil and sunlight.

Volvo also offers a special leather softener that should be applied after the cleaner and protectant. It leaves leather soft and smooth, and reduces friction between leather and other finishes in the vehicle.

Volvo recommends cleaning, protecting and conditioning your vehicle's leather two to four times a year. Ask your Volvo retailer about Leather Care Kit 951 0251 and Leather Softener 943 7429.

### CAUTION!

- Under no circumstances should gasoline, naphtha or similar cleaning agents be used on the plastic or the leather since these can cause damage.
- Take extra care when removing stains such as ink or lipstick since the coloring can spread.
- Use solvents sparingly. Too much solvent can damage the seat padding.
- Start from the outside of the stain and work toward the center.
- Sharp objects (e.g. pencils or pens in a pocket) or velcro fasteners on clothing may damage the textile upholstery.

## Cleaning the seat belts

Clean only with lukewarm water and mild soap solution.

## Cleaning floor mats

The floor mats should be vacuumed or brushed clean regularly, especially during winter when they should be taken out for drying. Spots on textile mats can be removed with a mild detergent.

## Bear in mind

- Take extra care when removing stains such as ink or lipstick since the coloring can spread.
- Use solvents sparingly. Too much solvent can damage the seat padding.
- Start from the outside of the stain and work toward the center.

---

---

## Chapter 8 - Volvo Service

Label information	116
Maintenance service, Warranty	117
Servicing	118
Emissions maintenance	119
Fuel/emissions systems	120
Lubrication	121
Engine oil	122
Power steering fluid, Brake/clutch system fluid reservoir	124
Washer fluid reservoir	125
Coolant	126
Engine compartment	127
Battery maintenance/Proposition 65 warning	128
Three-way catalytic converter	129

## Label information

### 1 Vehicle Emission Control Information

Your Volvo is designed to meet all applicable emission standards, as evidenced by the certification label on the underside of the hood. For further information regarding these regulations, please consult your Volvo retailer.

### 2 Vacuum hose routing

(underside of hood)

### 3 Loads and Tire Pressures, Canadian models

(on rear edge of passenger's door)

### 4 Model plate

Vehicle Identification Number (VIN). Codes for color and upholstery, etc. This plate is located in the engine compartment, on the inside of the left front fender.

### 5 Vehicle Identification Number (VIN) \*

The VIN plate is located on the top left surface of the dashboard. The VIN is also stamped on the right hand door pillar.

### 6 Federal Motor Vehicle Safety Standards (FMVSS) specifications (USA) and Ministry of Transport (CMVSS) standards (Canada)

Your Volvo is designed to meet all applicable safety standards, as evidenced by the certification label on the rear edge of the driver's door. For further information regarding these regulations, please consult your Volvo retailer.

### 7. Loads and tire pressures, U.S. models only

(on rear edge of passenger's door)

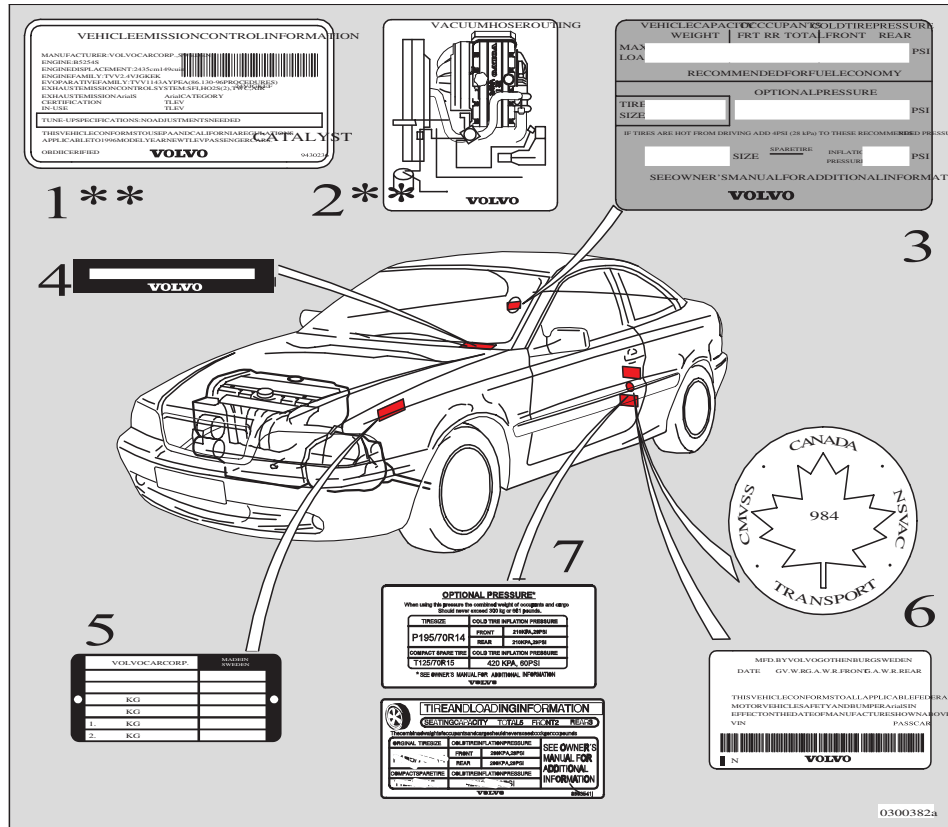

\* The Vehicle Identification Number (VIN) should always be quoted in correspondence concerning your vehicle with the retailer and when ordering parts.

\*\* These decals are located on the underside of the hood.

All specifications are subject to change without notice.

### Maintenance service

Volvo advises you to follow the service program which is outlined in the "Maintenance Records Manual". This maintenance program contains inspections and services necessary for the proper function of your car. The maintenance services contain several checks which require special instruments and tools and therefore must be performed by a qualified technician. To keep your Volvo in top condition, specify time tested and proven Genuine Volvo Parts and Accessories.

### The Federal Clean Air Act - U.S.

The Federal Clean Air Act requires vehicle manufacturers to furnish written instructions to the ultimate purchaser to assure the proper servicing and function of the components that control emissions. These services, which are listed in the "Warranty and Service Records Information booklet," are not covered by the warranty. You will be required to pay for labor and material used.

### Maintenance services

Your Volvo passed several major inspections before it was delivered to you, in accordance with Volvo specifications. The maintenance services outlined in the Warranty and Service Records Information booklet, many of which will positively affect your vehicle's emissions, should be performed as indicated. It is recommended that receipts for vehicle emission services be retained in case questions arise concerning maintenance.

Inspection and service should also be performed anytime a malfunction is observed or suspected.

Page 113 provides more information about maintenance of emission-related components.

### Applicable warranties - U.S and Canada

In accordance with applicable U.S. and Canadian regulations, the following list of warranties is provided.

- New Car Limited Warranty- U.S.
- New Car Warranty - Canada
- Parts and Accessories Limited Warranty
- Corrosion Protection Limited Warranty
- Seat belt and Supplemental Restraint Systems Limited Warranty - U.S
- Seat belt and Supplemental Restraint Systems Warranty - Canada
- Emission Design and Defect Warranty
- Emission Performance Warranty -U.S. and Province of British Columbia only

These are the Federal warranties; other warranties are provided as required by laws in your state or province. Refer to your separate Warranty and Service Records Information booklet for detailed information concerning each of the warranties.

## Servicing

### Hoisting the car

If a garage jack is used to lift the car, the two jack attachments points should be used. They are specially reinforced to bear the weight of the car. A garage jack can also be placed under the front of the engine support frame and under the reinforced plate in the spare wheel well. Take care not to damage the splash guard under the engine. **Ensure that the jack is positioned so that the car cannot slide off it. Always use axle stands or similar structures.**

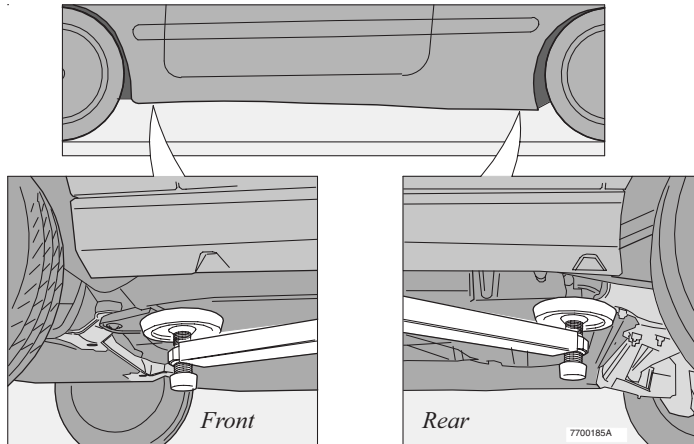

If a two-post hoist is used to lift the car, the front lift arm pads should be positioned under the rear engine frame mounts. The rear lift arm pads should be positioned under the rear supporting arm bracket.

**CAUTION:** Certain models have reduced ground clearance due to the design of the front spoiler. Please observe caution when driving the car onto a garage hoist.



## **Periodic maintenance helps minimize emissions**

Periodic maintenance will help keep your vehicle running well. Your Warranty and Service Records Information booklet provides a comprehensive periodic maintenance schedule up to 150,000 miles (240,000 km) of vehicle service. The schedule includes components that affect vehicle emissions. This page describes some of the emission-related components.

### **Engine air filter**

The engine air filter cleans particles from air entering the engine. Replace the engine air filter cartridge with a new one every 37,500 miles (60,000 km) under normal driving conditions. Replace the cartridge more often when the vehicle is driven under dirty and dusty conditions. The cartridge cannot be cleaned, and should always be replaced with a new one.

### **Fuel filter**

The fuel filter should be replaced at 105,000 miles (168,000 km). The filter is replaced as a complete unit. Replace more frequently if contaminated fuel is introduced into the tank, or if there is reason to suspect that this has occurred.

### **Fuel system, including filler cap, tank, lines, and connections**

The ability of the fuel system to contain hydrocarbons depends upon a leak-free system. Inspect fuel lines every 30,000 miles (48,000 km). Check for proper sealing of the fuel filler cap, which contains “O” ring seals.

**NOTE:** If the fuel filler cap is not closed tightly or if the engine is running when the car is refueled, the Check Engine light (Malfunction

Indicator) may indicate a fault. However, your vehicle’s performance will not be affected. Use only Volvo original or approved fuel filler caps.

### **Timing belt**

For proper functioning of the engine and emission control systems, the timing belt and belt tensioner must be replaced every 105,000 miles (168,000 km). Engine damage will occur if the belt fails.

### **PCV system**

(on turbocharged models)

The nipple in the intake manifold and the filter at the end of the PCV hose in the air cleaner should be inspected and cleaned at 105,000 miles (168,000 km), and again at 150,000 miles (240,000 km).

### **Spark plugs**

The spark plugs should be replaced every 60,000 miles (96,000 km) under normal driving conditions. City driving or fast highway driving may necessitate replacement sooner.

Under normal driving conditions, spark plugs require no maintenance between replacement intervals. When installing new plugs, be sure to use the right type and to tighten them correctly. When changing the plugs, clean the terminals and rubber seals. Also check that the suppressor connectors are in good condition. Cracked or damaged connectors should be replaced.

## Fuel/emissions systems

### Fuel system

The fuel system is all-electronic and is microprocessor-controlled. It can continually compensate for variation in engine load, speed and temperature to give the best economy and power. A mass air flow sensor measures the inducted air. In this way the system can make instantaneous adjustments for changes in air temperature or density, thus always assuring the best economy with the lowest possible exhaust emissions.

### Heated oxygen sensor(s)

This is an emission control system designed to reduce emissions and improve fuel economy. The heated oxygen sensor monitors the composition of the exhaust gases leaving the engine. The exhaust gas analysis is fed into an electronic module. This adjusts the air-fuel ratio to provide optimum conditions for combustion and efficient reduction of the three major pollutants (hydrocarbons, carbon monoxide and oxides of nitrogen (NO<sub>x</sub>) by a three-way catalytic converter.

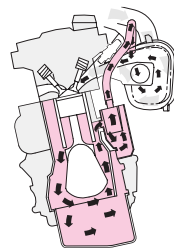

*Crankcase ventilation*

### Crankcase ventilation

The engine is provided with positive crankcase ventilation which prevents crankcase gases from being released into the atmosphere. Instead, the crankcase gases are routed to the intake manifold and cylinders.

### Evaporative control system

The car is equipped with an evaporative control system which prevents gasoline vapor from being released into the atmosphere.

The system consists of a fuel tank with filler pipe and cap, a rollover valve, a Fill Limit Vent Valve (FLVV), vapor vent lines, a charcoal canister, a purge line, a purge control valve and engine connections .

In addition, there is a pressure sensor connected to the fuel tank and a filter-protected Canister Close Valve (CCV) on the atmospheric side of the canister, for system diagnosis.

The gasoline vapor is channeled through the rollover valve and the FLVV via the vapor vent lines into the charcoal canister, where it is

stored. When the engine is started, the gasoline vapor is drawn from the charcoal canister to the engine's air intake system and into the combustion process.

#### NOTE:

- If the fuel filler cap is not closed tightly or if the engine is running when the car is refueled, the Malfunction Indicator Lamp may indicate a fault.
- During a transitional period, a small number of service stations may still have fuel nozzles that are not compatible with the fuel filler neck on cars equipped with the evaporative emission control system mandated by the U.S. Environmental Protection Agency and the California Air Resources Board. If you experience difficulties in refueling your vehicle, please ask the gas station attendant for assistance.

**CAUTION:** Fuel must not be siphoned from the fuel tank. This will damage the evaporative emission control system.

## Lubrication

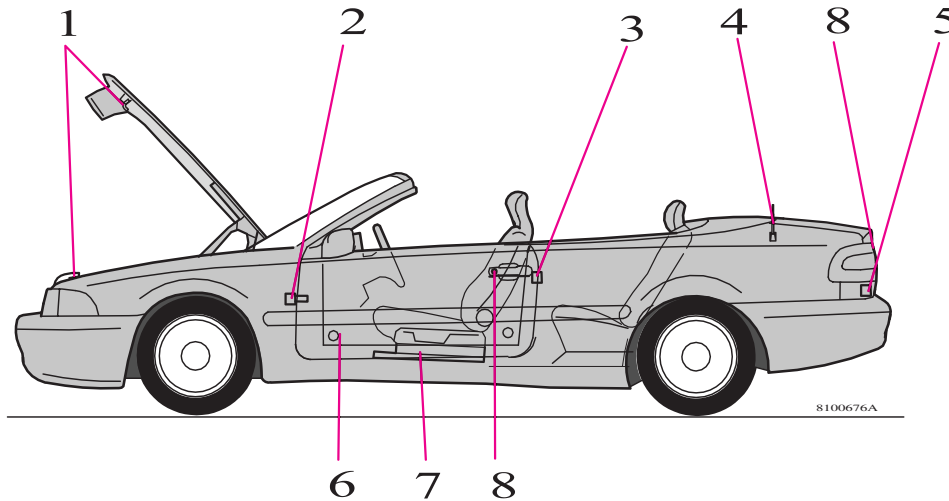

No.	Lubrication point	lubricant	No.	Lubrication point	lubricant
1	Hood lock and latch	Oil	6	Power window winders	Oil, grease
2	Door stop and hinges	Oil	7	Front seat floor rails and latch	Oil
3	Door lock catch plate	Oil	8	Door/trunk locks	Volvo teflon lock spray
4	Power antenna	WD 40 or similar			
5	Trunk lock catch plate	Low temperature grease			

To avoid rattles and unnecessary wear, the body should be lubricated at regular service intervals. This should be done by an authorized Volvo retailer.

Lubrication of the convertible top mechanism should be done by an authorized Volvo retailer.

## Engine oil

### Checking the oil level

The oil level should be checked every time the car is refueled. This is especially important during the period up to the first service.

**CAUTION:** Not checking the oil level regularly can result in serious engine damage if the oil level becomes too low.

Park the car on a level surface and wait for at least 3 minutes after the engine has been switched off. Be sure the oil level is maintained between the upper and lower marks on the dipstick. If oil is added, it should reach the MAX mark on the dipstick. Low oil level can cause internal damage to the engine and overfilling can result in high oil consumption. The distance between the dipstick marks represents approx. 1.6 US qts (1.5 liters). The oil should preferably be checked when cold, before the engine has been started.

**NOTE:** The engine must be stopped when checking the oil.

### Draining the oil

Drain the oil after driving while it is still warm.

**WARNING!**  
The oil may be very hot.

If you change the engine oil and filter yourself, your Volvo retailer can assist you in disposing of the used oil. Engine oil can be harmful to your skin - gloves should be worn when performing this work.

### To add or change oil

Add oil of the same kind as already used.

Capacity (including filter): 6.2 US qts (5.8 liters).

**The oil filter should be replaced at every oil change.**

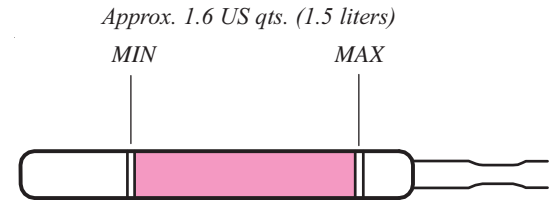

2200092A

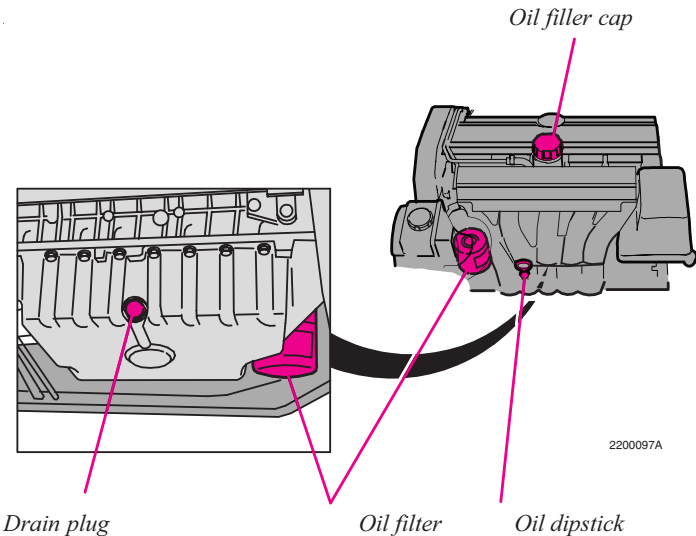

2200097A

**WARNING!** Oil spilled on a hot exhaust pipe constitutes a fire risk.

## Oil quality

Engine oil must meet the minimum ILSAC specification GF-2, including ACEA A1, API SJ, SJ/CF and SJ/Energy Conserving.

Your Volvo has been certified to standards using ILSAC oil specification GF-2 5W-30. Volvo recommends use of oil with a quality rating equal to or higher than ILSAC GF-2. Equivalent and better oils include ACEA A1, API SJ, SJ/CF, and SJ/Energy conserving. Lower quality oils may not offer the same fuel economy, engine performance, or engine protection.

Volvo Cars recommends Castrol.

Depending on your driving habits, premium or synthetic oils may provide superior fuel economy and engine protection. Consult your Volvo retailer for recommendations on premium or synthetic oils.

**Oil additives must not be used.**

**NOTE:** Synthetic oil is not used when the oil is changed at the normal maintenance services. This oil is only used at customer request, at additional charge. Please consult your Volvo retailer.

## Oil viscosity (stable ambient temperatures)

### Operation in temperate climates

Incorrect viscosity oil can shorten engine life. Under normal use when temperatures do not exceed 86° F (30° C), SAE 5W-30 will provide good fuel economy and engine protection. See the viscosity chart at right.

### Operation in hot climates

When temperatures exceed 86° F (30° C) in your area, Volvo recommends, for the protection of your engine, that you use a heavier weight oil, such as SAE 10W-30. See the viscosity chart at right.

### Extreme engine operation

Synthetic oils meeting SAE 10W-30 and complying with oil quality requirements are recommended for driving in areas of sustained temperature extremes (hot or cold), when towing a trailer over long distances, and for prolonged driving in mountainous areas.

## Changing oil and oil filter

Oil and oil filter changes should be made at 7,500 mile (12,000 km) intervals.



*The API Service Symbol*

The API Service Symbol “donut” is divided into three parts:

- The top half describes the oil’s performance level.
- The center identifies the oil’s viscosity.
- The bottom half tells whether the oil has demonstrated energy-conserving proper ties in a standard test in comparison to a reference oil.

## Viscosity (stable ambient temperatures):

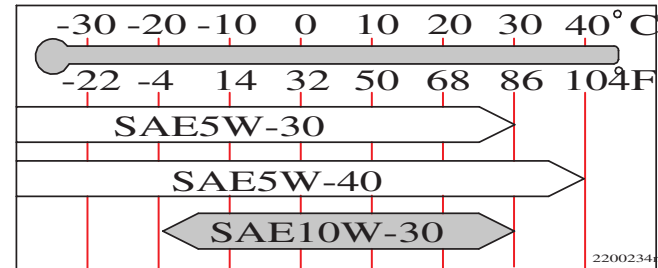

## Power steering fluid, Brake/clutch fluid reservoir

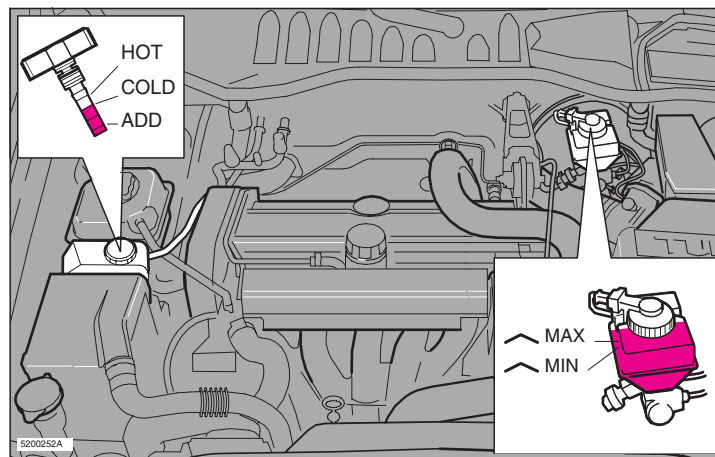

*Power steering fluid*

*Brake (clutch) fluid*

### Power steering fluid

The dipstick has marks for checking hot and cold oil. The oil level when the engine is cold must never be higher than the **COLD** mark. After the engine has reached normal operating temperature, the level may not be higher than the **HOT** mark. Top up when the level is at the **ADD** mark. Check the level at every service.

Fluid type: Volvo synthetic power steering fluid (Pentosin CHF 11S)  
P/N 8713081 or equivalent.

Replace: No fluid change required

**NOTE:** If a problem should occur in the power steering system or if the car has no electrical current and must be towed, it is still possible to steer the car. However, keep in mind that greater effort will be required to turn the steering wheel.

### Brake and clutch systems

The brake and clutch systems share the same fluid reservoir. The fluid level should be between the MIN and MAX marks.

Fluid type: DOT 4+ boiling point >536°F (280°C), P/N 9437433

Replace: Every second year or 30,000 miles (48,000 km). The fluid should be replaced once a year or every 15,000 miles (24,000 km) when driving under extremely hard conditions (mountain driving, etc.)

Check, without removing the cap, that the level is above the “**MIN**” mark of the fluid reservoir.

Always entrust brake/clutch fluid changing to an authorized Volvo retailer.

## Washer fluid reservoir

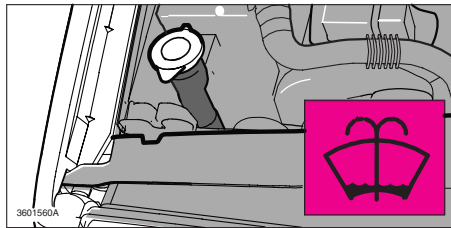
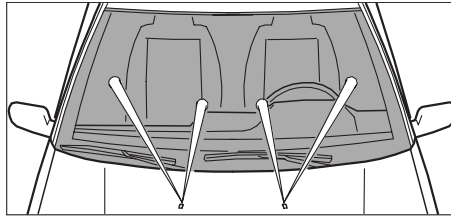

### Washer fluid reservoir

The washer fluid reservoir is located in the engine compartment and holds approx. 4.7 US qts. (4.5 liters).

During cold weather, the reservoir should be filled with windshield washer solvent containing antifreeze.

## Coolant

### Check coolant level

The cooling system must be filled with coolant and not leak to operate at maximum efficiency. Check the coolant level regularly. The level should be between the “MAX” and “MIN” marks on the expansion tank. The check should be made with particular thoroughness when the engine is new or when the cooling system has been drained.

Do not remove the filler cap other than for topping up with coolant. Frequent removal may prevent coolant circulation between the engine and the expansion tank during engine warm up and cooling.

**Capacity:** 7.4 US qts. (7.0 liters)

**Coolant:** Volvo Genuine Coolant/Antifreeze only.

**NOTE:** Do not top up with water only. Water by itself reduces the rust-protective and antifreeze qualities of the coolant and has a lower boiling point. It can also cause damage to the cooling system if it should freeze.

#### **WARNING!**

If the engine is warm and you are going to top up coolant, unscrew the tank cap slowly in order to allow any excess pressure to escape.

**CAUTION:** The cooling system must always be kept filled to the correct level. If it is not kept filled, there can be high local temperatures in the engine which could result in damage. Different types of antifreeze/coolant may not be mixed.



## Engine compartment C70

- 1 Supplementary fuse box
- 2 Expansion tank, coolant
- 3 Engine designation plate
- 4 Clutch/brake system fluid reservoir
- 5 Oil filler cap, engine
- 6 Relay/Main fuse box
- 7 Washer fluid reservoir
- 8 Power steering fluid reservoir
- 9 Dipstick - engine oil
- 10 Dipstick - automatic transmission
- 11 Air cleaner
- 12 Battery
- 13 Data plate

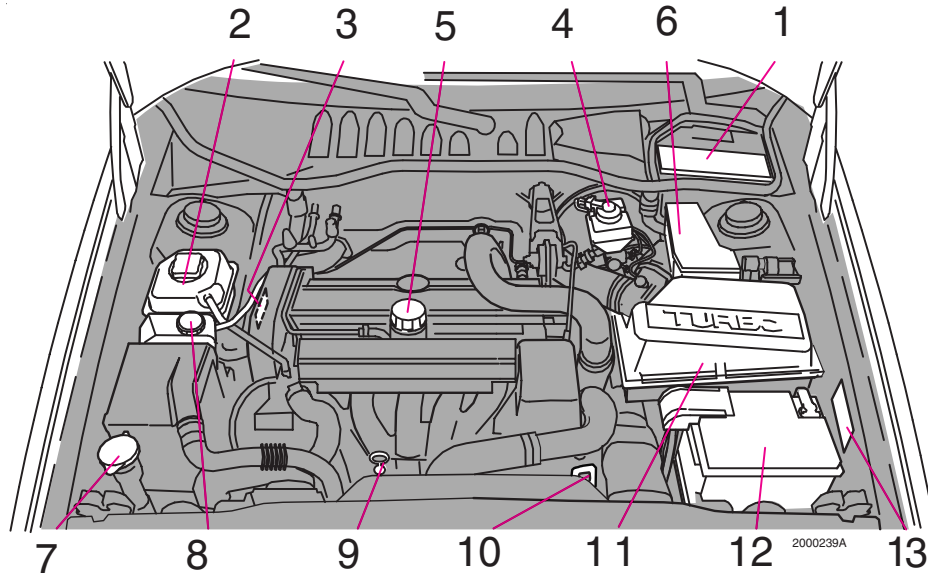

### WARNING:

The coolant fan may start or continue to operate (for up to 6 minutes) after the engine has been switched off.

## Battery maintenance

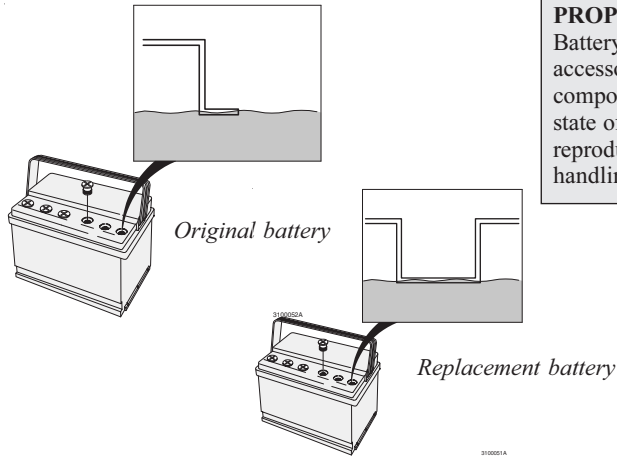

Correct fluid level

### PROPOSITION 65 WARNING!

Battery posts, terminals, and related accessories contain lead and lead compounds, chemicals known to the state of California to cause cancer and reproductive harm. Wash hands after handling.

### Battery maintenance

Driving habits and conditions, climate, the number of starts, etc. all affect the service life and function of the battery. In order for your battery to perform satisfactorily, keep the following in mind:

- Check the fluid level in each cell in the battery every 24 months or every 15,000\* miles (24,000 km), whichever is sooner. The fluid level in each battery cell should be checked - use a screwdriver to open the caps and a flashlight to inspect the level.
- If necessary, add **distilled water** to

\* More frequently in warm climates.

approximately 0.4 in. (10 mm) above the plates in the cell or to the level indicator. See the illustrations above.

- Check that the battery cables are correctly connected and properly tightened.
- Never disconnect the battery when the engine is running, for example when changing the battery.
- The battery cable should be disconnected from the battery when using a battery charger.
- Switch off the radio before disconnecting the battery. If your radio has an antitheft code and the battery is disconnected, the radio code has to be reentered in order for the radio to function.

### Battery warning symbols



**Wear protection goggles**



**See inside for details**



**Keep away from children**



**Corrosive**



**No smoking, no open flames, no sparks**



**Explosion**

## Three-way catalytic converter

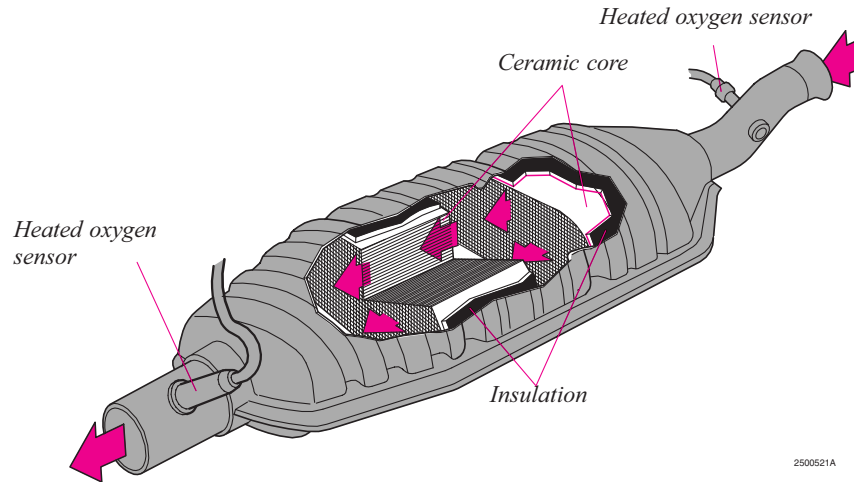

### Three-way catalytic converter cautions

- Keep your engine properly tuned. Certain engine malfunctions, particularly involving the electrical, fuel or distributor ignition systems, may cause unusually high three-way catalytic converter temperatures. **Do not continue to operate your vehicle if you detect engine misfire, noticeable loss of power or other unusual operating conditions, such as engine overheating or backfiring.** A properly tuned engine will help avoid malfunctions that could damage the three-way catalytic converter.
- Do not park your car over combustible materials, such as grass or leaves, which can come into contact with the hot exhaust system and cause such materials to ignite under certain wind and weather conditions.
- Excessive starter cranking (in excess of one minute), with an intermittently firing or flooded engine, can cause three-way catalytic converter or exhaust system overheating.

- Remember that tampering or unauthorized modifications to the engine or the vehicle may be illegal and can cause three-way catalytic converter or exhaust system overheating. This includes:
  - Altering fuel injection setting or components.
  - Altering emission system components or location or removing components.
  - Repeated use of leaded fuel.

**NOTE:** Unleaded fuel is required for cars with three-way catalytic converters.



---

---

## Chapter 9 - Specifications

Oil/fluids specifications	132
Engine specifications	133
Cooling/fuel/distributor ignition systems	134
Front/rear suspensions	134
Transmission, Capacities, Vehicle loading	135
Electrical system/bulbs	136
Dimensions and weights	137
On Call Roadside assistance	138

## Oil/fluid specifications

### Engine Oil

Meeting or exceeding ILSAC specification GF-2, including ACEA A1, API SJ, SJ/CF, and SJ/Energy Conserving.

**Oil additives must not be used.**

Engine oil	<b>Quality:</b> Meeting API specification SJ, SJ/CF, or SJ/Energy Conserving	<b>Capacity</b> (incl. filter): 6.2 US qts. (5.8 liters)
Automatic transmission fluid	<b>Quality:</b> AW5: Only Volvo gearbox oil (1161540-8). Do not mix with other oils.	<b>Capacity:</b> 8 US qts. (7.5 liters)
Manual transmission fluid	<b>Quality:</b> Volvo synthetic gearbox oil 1161423	<b>Capacity:</b> 2.2 US qts. (2.1 liters)
Power steering fluid	<b>Quality:</b> Volvo synthetic power steering fluid (Pentosin CHF 11S) P/N 8713081 or equivalent.	<b>Capacity:</b> 0.95 US qts. (0.9 liters)
Brake fluid	<b>Quality:</b> DOT 4+ boiling point >536°F (280°C), P/N 9437433	<b>Capacity:</b> 0.64 US qts. (0.6 liters)

**All specifications are subject to change without notice.**

## Engine specifications

### Engine

Liquid-cooled gasoline, 5-cylinder, in-line engine. Aluminum alloy cylinder block with cast-iron cylinder liners cast directly into the block. Aluminum alloy cylinder head with double overhead camshafts and separate intake and outlet channels.

Engine lubrication is provided by an eccentric pump driven from the crankshaft. Full-flow type oil filter. Exhaust emission control is accomplished by multiport fuel injection, heated oxygen sensor(s) and three-way catalytic converter.

### Charge air cooler (Intercooler)

Turbocharged engines employ a turbo-compressor to force air into the engine inlet manifold and a charge air cooler to cool the compressed inlet air. The resulting increase in air flow raises pressure in the intake manifold by approx. 8.7 psi (over atmospheric pressure) and engine power output by approx. 50 horsepower over that developed by the normally-aspirated engine. The charge air cooler (which resembles a radiator) is located between the turbo-compressor and inlet manifold.

### Designation:

**Volvo B 5234 T9**

Output

242 hp at 5400 rpm  
(180 kW/90 rps)

Max. torque

243 ft. lbs. at  
2400-5100 rpm  
(330 Nm/40-85 rps)

No. of cylinders

5

Bore

3.19" (81 mm)

Stroke

3.54" (90 mm)

Displacement

2.3 liters

Compression ratio

8.5:1

No. of valves

20

### Designation: Volvo B 5244 T7

Output

197 hp at 5700 rpm  
(147 kW/95 rps)

Max torque

210 ft. lbs. at 1800-  
5000 rpm  
(285 Nm/30-83 rps)

No. of cylinders

5

Bore

3.27" (83 mm)

Stroke

3.54" (90 mm)

Displacement

2.4 liters

Compression ratio

9.0:1

No. of valves

20

## Specifications

### Cooling system

Type:	Positive pressure, closed system
Thermostat begins to open at	180° F (87° C)
Coolant:	Volvo original coolant/antifreeze
Capacity:	7.4 US qts. (7.0 liters)

### Fuel system

The engine is equipped with a multiport fuel injection system.

### Distributor ignition system

Firing order:	1-2-4-5-3
Distributor ignition setting:	Not adjustable
Spark plugs:	Champion RC87PYC (or equivalent)
Spark plug gap:	0.03" (0.75 mm)
Tightening torque:	18.4 ft. lbs. +/- 3.7 ft. lbs. (25 Nm +/- 5 Nm)

#### WARNING!

The distributor ignition system operates at very high voltages. Special safety precautions must be followed to prevent injury. Always turn the ignition off when:

- Replacing distributor ignition components e.g. plugs, coil, etc.
- Do not touch any part of the distributor ignition system while the engine is running. This may result in unintended movements and body injury.

### Front suspension

Spring strut suspension with integrated shock absorbers and control arms linked to the support frame. Power-assisted rack and pinion steering. Safety type steering column.

The alignment specifications apply to an unladen car but include fuel, coolant and spare wheel.

Toe-in measured on the wheel rims:	2.4 mm +/- 0.7 mm
Toe-in measured on tire sides:	2.9 +/- 0.9 mm

### Rear suspension

Delta-link individual rear wheel suspension with longitudinal support arms, double link arms and track rods.

Toe-in measured on the tire sides:	4° +/- 10°
------------------------------------	------------

All specifications are subject to change without notice.



## Power transmission

### Manual transmission: M 56 H

Single-disc dry plate clutch. All-synchromesh on all gears including reverse; integrated final drive. Operation via a floor mounted gear lever.

**Final drive ratio** 4.00:1

### Reduction ratios

1st gear	3.07:1
2nd gear	1.77:1
3rd gear	1.19:1
4th gear	0.87:1
5th gear	0.70:1
Reverse	2.99:1

### Automatic transmission: AW 55-50 LE

4 or 5-speed automatic electronically controlled gearbox comprising a hydraulic torque converter with a lock-up function; planetary gear, integrated final drive.

Operation via a floor mounted gear selector lever. Drive shafts with symmetrical joint location. Overdrive.

**Final drive ratio** 2.44:1

### Reduction ratios

1st gear	4.77:1
2nd gear	3.00:1
3rd gear	1.96:1
4th gear	1.32:1
5th gear	1.02:1
Reverse	3.23:1

## Capacities

Fuel tank	18 US gal. (68 liters)
Cooling system	7.4 US qts. (7.0 liters)
Engine oil (incl. filter)	6.1 US qts. ( 5.8 liters)
Automatic transmission	2 US gals (7.6 liters)
Manual transmission	2.2 US qts. (2.1 liters)
Power steering fluid	0.95 US qts (0.9 liters)
Washer fluid reservoir	4.7 US qts. (4.5 liters)
Brake/clutch system	0.6 US qts (0.6 liters)

## Vehicle loading

The tires on your Volvo should perform to specifications at all normal loads when inflated as recommended on the tire information label. The label is located on the inside of the fuel filler door. The label also lists vehicle load limits. Do not load your car beyond the indicated limits.

### WARNING!

Improperly inflated tires will reduce tire life, adversely affect vehicle handling and can possibly lead to failure resulting in loss of vehicle control without prior warning.

All specifications are subject to change without notice.

## Specifications

### Electrical system

12 Volt, negative ground.

Voltage-controlled generator. Single-wire system with chassis and engine used as conductors.

### Battery

Voltage 12,6 Volt

Capacity 520 A/100 min

(certain markets) 420 A/75 min

The battery contains corrosive and poisonous acids. It is of the utmost importance that old batteries are disposed of correctly. Your Volvo retailer can assist you in this matter.

### Generator

Rated output 1400 W

Max. current 120 A

### Bulbs

Bulb	US no.	Power	Socket	No/bulbs
Headlights				
High beam	HB3	65W	-	2
Low beam	H11	55W	-	2
Front parking lights/ turn signals	3357NA	30/7W/	30/2.2cpW 2.5 x 15q	2
Turn signals, rear	-	21W	BAU 15	2
Side direction indicators	-	5W	W 2.1x9.5 d	2
Tail lights	67	5W/4cp	BA 15 s	4
Brake lights	1156	21W/32cp	BA 15 s	2
Back-up lights	1156	21W/32cp	BA 15 s	2
Rear fog light	1156	21W/32cp	BA 15 s	1

Bulb	US no.	Power	Socket	No/bulbs
Front fog lights	H1	55 W	P14.5s	2
License plate light	-	5 W	W 2.1x9.5d	2
Door open warning light	-	3 W	W 2.1x9.5d	4
Door step courtesy lights	-	5W	W 2.1x9.5d	2
Trunk light	-	10 W	SV 8.5	1
Glove compartment light	-	2 W	BA 9s	1
Vanity mirror lights	-	1.2 W	-	2
Instrument lighting illumination, control panel	-	3 W	W 2.1x9.5d	3
	-	1.2 W	W 2x4.6 d	-
gear selector (auto- matic trans.)	-	1.2 W	W 2x4.6d	1
rear ashtray	-	1.2 W	W 2x4.6d	1
Instrument warning/ indicator lights	-	1.2 W	W 2x4.6d	-
Front courtesy lights	-	5 W	BA 9s	2
Rear reading lights	-	5 W	BA 9s	2

## Specifications

### Dimensions

Length	186 in. (472 cm)
Width	71.5 in. (182 cm)
Height	56.3 in. (143 cm)
Wheelbase	105 in. (266 cm)
Track, front	59.9 in. (151.8 cm)
Track, rear	59.8 in. (151.6 cm)
Turning circle (between curbs)	38.4 ft. (11.7 m)
Cargo capacity	8.1 cu. ft. (223 liters)

	USA	Canada
<b>Max trunk-mounted luggage rack load</b>		
C70 Convertible	110 lbs	50 kg
<b>Max trailer weight (w/o brakes)</b>	1100 lbs	500 kg
<b>Max trailer weight (with brakes)</b>		
2" ball	3300 lbs	1500 kg
1 7/8" ball	2000 lbs	900 kg
Max tongue weight **	165 lbs	75 kg

\* The max permissible axle loads or the gross vehicle weight must not be exceeded.

\*\* See also section "Trailer towing"

### Weights

	USA	Canada
<b>Gross vehicle weight (GVW)</b>		
(Aut.)	4470 lbs	2030 kg
(Man.)	4430 lbs	2010 kg
<b>Capacity weight *</b>		
(Aut)	725 lbs	330 kg
(Man)	735 lbs	335 kg
<b>Curb weight</b>	3583-3649 lbs	1630-1660 kg
<b>Permissible axle weight, front</b>		
(Aut.)	2440 lbs	1110 kg
(Man.)	2400 lbs	1090 kg
<b>Permissible axle weight, rear</b>		
All models	2140 lbs	970 kg

#### WARNING!

When adding accessories, equipment, luggage and other cargo to your vehicle, the total loaded weight capacity of the vehicle must not be exceeded.

All specifications are subject to change without notice.

## On Call Roadside Assistance



### Volvo On Call Roadside Assistance

Your new Volvo comes with a four-year On Call Roadside Assistance program. Additional information, features, and benefits are described in a separate information package in your glove compartment.

If you have misplaced your package, dial:

**In the U.S.A.**

1-800-63-VOLVO (1-800-638-6586)

**In Canada:**

1-800-263-0475



### Technician certification

In addition to Volvo factory training, Volvo supports certification by the National Institute for Automotive Excellence (A.S.E.). Certified technicians have demonstrated a high degree of competence in specific areas. Besides passing exams, each technician must also have worked in the field for two or more years before a certificate is issued. These professional technicians are best able to analyze vehicle problems and perform the necessary service procedures to keep your Volvo at peak operating condition.

All specifications are subject to change without notice.

---

---

## Chapter 10 - Audio systems

SC-813	140
SC-816	153
SC-901	169
General information	192

## Audio system SC-813 (certain models)

The following pages describe the use of your SC-813 Cassette radio and CD remote control

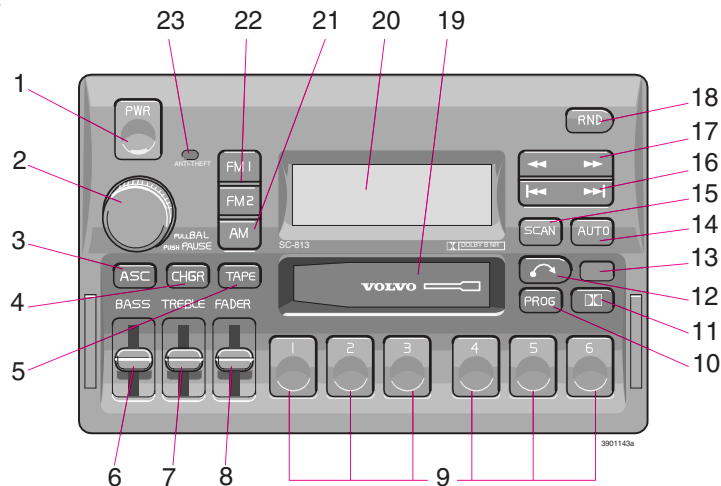

1. On/off (push)
2.
  - Volume (turn)
  - Pause/Mute (push)
  - Balance (pull)
3. Active Sound Control
4. CD changer selector
5.
  - Tape mode selector
  - Tape direction selector PROG
6. Bass control
7. Treble control
8. Fader control
9.
  - Preset buttons
  - CD-Disc No. selector

10. PROG - Reversing the tape
11. Dolby B NR button
12. Cassette eject
13. Not in use
14. Scan
15. Auto seek memory
16.
  - Seek tuning up/down
  - TP-Next/Previous song
  - CD-Next UP/Previous DOWN track
17.
  - Manual tuning
  - TP-fast forward/Rewind
  - CD-Music searchUP/DOWN

18. RND button
19. Cassette slot
20. Display
21. Waveband selector (AM)
22. Waveband selectors (FM)
23. Anti-theft LED

**TP** = Applicable only in Tape Mode

**CD** = Applicable only when in CD mode and connected to a CD changer.

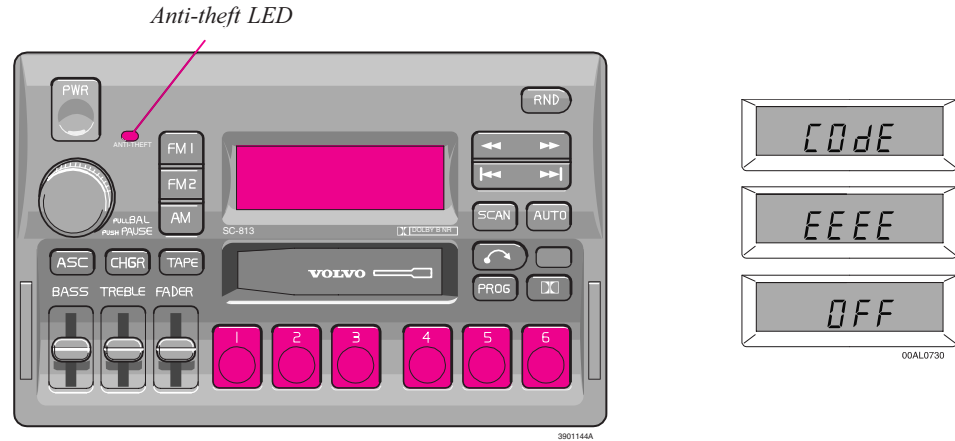

### Anti-theft code

The radio features anti-theft circuitry. If the set is removed from the vehicle or if the battery power is disconnected, a special code must be entered to enable operation of the set.

**Your Volvo retailer will supply you with this code.**

**NOTE:** Volvo recommends that you store the radio code in a safe place.

A red LED will flash when the key had been removed **from the ignition to confirm that the anti-theft circuitry has been activated.**

### To enter the code

After installation or when the set has been disconnected from power, the set displays "COdE" when it is switched on.

Enter the 4-digit code using the preset buttons.

If the correct code is entered, "on" is displayed and the set is ready to use.

If you enter an incorrect code you must enter the correct code again from the beginning.

### Incorrect code

If an incorrect code has been entered "rPt" is displayed. Enter the correct code.

After three unsuccessful coding attempts the set will lock and remain locked for two hours. "OFF" is displayed.

#### During this waiting period:

- the battery must be connected
- the ignition key must be turned to position I
- the unit must be turned on

Make sure the headlights are turned off to help prevent battery drain (please refer to page 20 for information on turning the headlights off).

Enter the code again once this time has elapsed.

## Radio SC-813

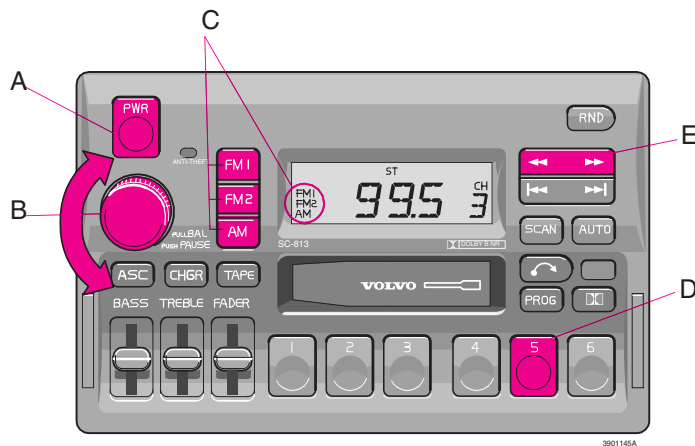

### A - On/off switch

Push the button to switch on the radio. Press the button slightly longer to turn the radio off.

### B - Volume control

Turn the button clockwise to increase the volume. The volume control is electronic and has no end stop.

### C - Waveband selector

The desired waveband is set by pressing one of the waveband selector buttons. The frequency and waveband is shown on the display.

**NOTE:** There are two FM wavebands and one AM waveband. This makes it possible to store 2 x 6 FM stations and 6 AM stations in memory.

### D - Setting frequency selection

The radio can be used in most parts of the world by changing the frequency selection intervals as follows:

Depress and hold preset button 5 and turn the radio ON. "USA" will flash on the display.

Each time button 5 is pressed, the frequency selection will change from "USA" to "AUS", etc. When the correct country name is displayed, wait 5 seconds and the radio will be ready for use.

### E - Manual tuning

Press the left side tune button to tune to lower frequencies and the right side to tune to higher frequencies. The tuned frequency is displayed.

ST will be displayed to indicate stereo FM reception.



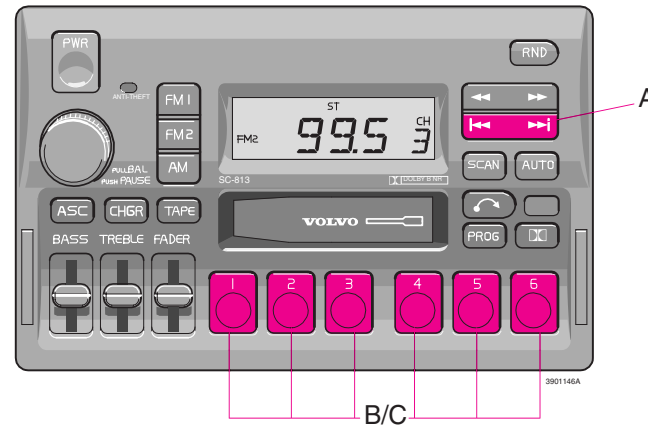

### A - Seek tuning up/down

Press the left side tune button to tune to lower frequencies and the right side to tune to higher frequencies. The radio seeks the next audible station and stops there. If you wish to continue the seek tuning, press the tune button again.

### B - Preset programming

1. Tune to the desired frequency.
2. Depress and hold a preset button. The audio will cut out. Keep the button depressed until the audio comes on again (approx. 2 seconds).
3. The frequency is now stored on this preset button.

### C - Preset buttons

To select a pre-programmed radio frequency, depress the preset button. The set frequency will be displayed.

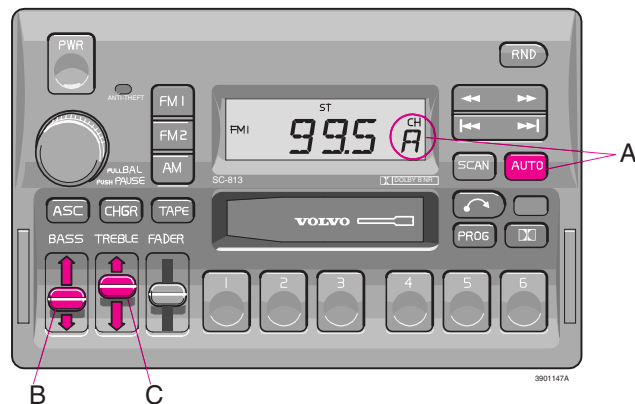

### A - Automatic programming (Auto)

**Please note that this function will not interfere with pre-stored stations on buttons 1-6.**

This function automatically seeks and stores up to 8 strong AM or FM stations.

This is especially useful when travelling in areas where radio stations are unfamiliar.

1. Depress and hold the "AUTO" button for **at least 1 second**. A number of strong stations (max. 8) on the chosen waveband are now automatically stored in the memory.

If there are no audible stations, "- - -" is displayed.

2. Press the "AUTO" button (**for less than 1 second**) to obtain another autostored station.

A new station will be selected each time the button is pressed momentarily.

### B - Bass control

Adjust the bass by sliding the control up or down (up to increase, down to decrease).

A "detent" indicates "equalized" bass.

### C - Treble control

Adjust the treble by sliding the control up or down (up to increase, down to decrease).

A "detent" indicates "equalized" treble.

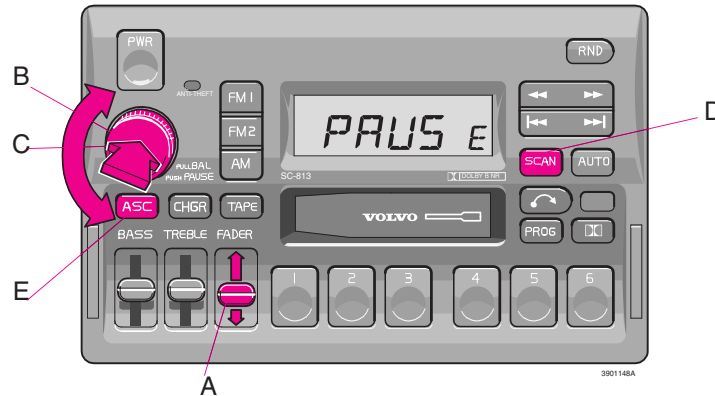

**A - Fader control**

Adjust front/rear speaker balance by sliding the control up or down (up to direct more sound to the front speakers, down to direct more sound to the rear speakers).

The "detent" indicates "equalized" front /rear balance position.

**B - Pause function**

Press the "volume" knob to temporarily mute the sound. "PAUSE" is displayed.

**C - Balance control**

Pull out the "volume" knob and adjust the left/right balance by turning the knob counter-clockwise or clockwise.

**D - Scan**

Press this button to listen to each station for five seconds. Press it again to stop scanning. "Scan" will be displayed during scanning.

**E - Active sound control (ASC)**

The ASC function automatically adjusts the volume level of the audio system according to driving speed.

To deactivate ASC depress the "ASC" button.

To activate ASC, depress the "ASC" button until "ASC" is displayed.

## Cassette deck

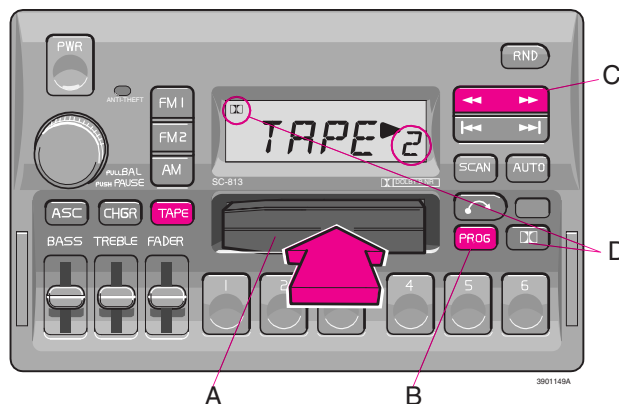

### A - Cassette slot

The cassette is inserted with the open side to the right (side 1 or A of the cassette upwards).



When the cassette is inserted, the radio is disengaged and the cassette will start to play automatically. "TAPE▷" or "TAPE◁" is displayed to indicate which side of the tape is being played. When one side of the tape has been played the unit will automatically play the other side (auto-reverse). The cassette can be inserted or ejected even when the unit is switched off.

### B - Reversing the tape (PROG)

Press the button to play the other side of the tape.

The side of the tape being played will be displayed.

### C - Fast winding

The tape is advanced with  and rewind with .

Fast winding can be stopped by pressing either the selected button or the fast wind button again or by pressing the "TAPE" button.

### D - Dolby B NR button

Press this button when you use tapes recorded with the Dolby B noise reduction system.

The Dolby symbol  will be indicated in the display.



### A - Next selection

Press the  button and the tape will automatically advance to the next song. There must be a gap (no audio sound) of approx. 5 seconds between songs for this function to operate.

### B - Previous selection

Press the  button and the tape will automatically rewind to the previous song.

There must be a gap (no audio sound) of approx. 5 seconds between songs for this function to operate.

### C - Pause

If you press the "volume" knob the tape is stopped, the unit is silent and "PAUSE" is displayed. To restart the tape press the knob again.

### D - Scan

Press this button to listen to the first five seconds of each song. Press this button or the "TAPE" button to stop scanning. During scanning "SCAN" will be displayed. There must be a gap (no audio sound) of approx. 5 seconds between songs for this function to operate.

## Cassette deck

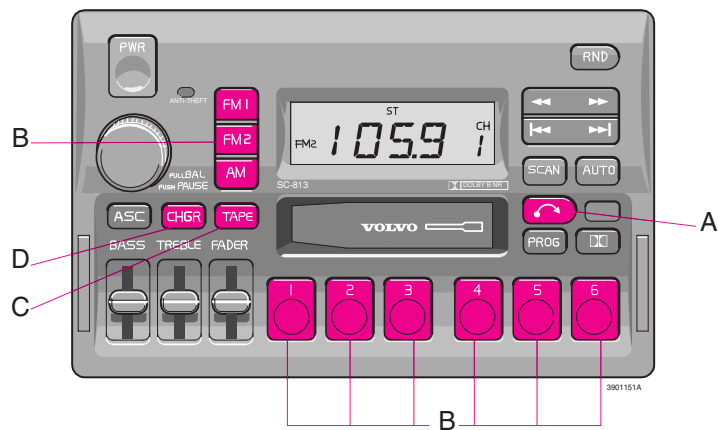

### A - Cassette eject

If the button is pressed the tape will stop and the cassette will be ejected. The radio will be automatically engaged. The radio or CD changer will engage automatically (depending on which mode was activated before the tape was played).

### B - To re-enter Radio mode

Push one of the waveband selector buttons  
When the unit re-enters Radio mode, the cassette will not be ejected.

### C - To re-enter Tape mode

If the Tape function has been disconnected and the cassette has not been ejected, the Tape mode can be re-entered by pressing the "TAPE" button.

### D - To re-enter CD changer mode

If the CD changer function has been disconnected, the CD changer mode can be re-entered by pressing the "CHGR" button.



## CD - Changer (retailer option)

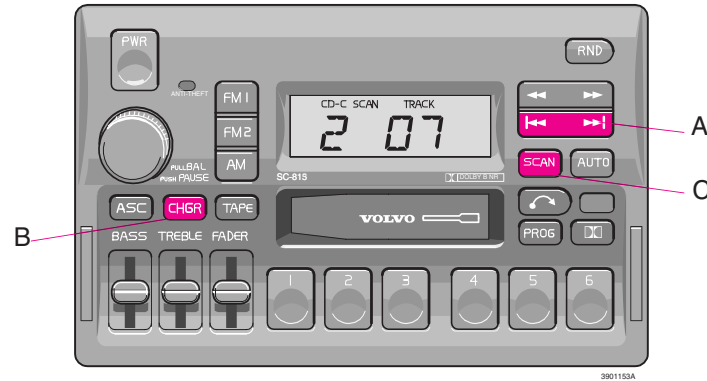

### A - Changing the selected track number

Press for forward selection or for backward selection. The chosen disc number and track number will be displayed.

### B - Playing-time display

When the "CHGR" button is pressed the playing time for the current track is displayed for 5 seconds.

### C - Scan

Press this button to listen to the first ten seconds of each track. Press it again to stop scanning. During scanning "SCAN" will be displayed.



## CD - Changer (retailer option)

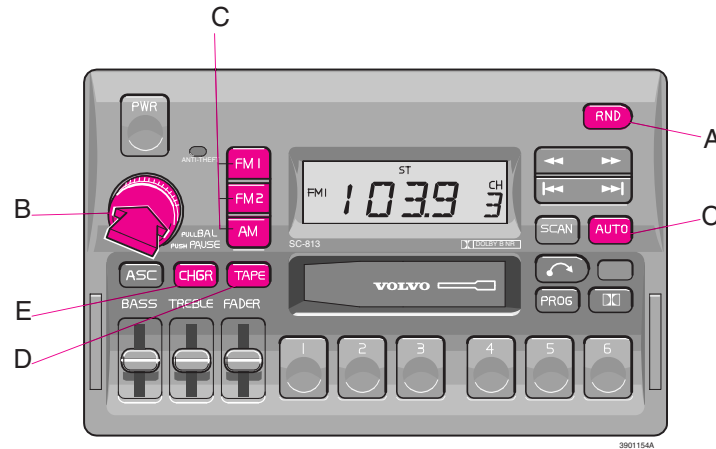

### A - Random choice

Press "RND" to actuate the random mode. From a disc chosen at random, 4 tracks will be played (also chosen at random)\*. A new disc will then be played in the same way. "RND" will be displayed when this function is engaged.

\* The random function may cause a disc to be played more than once before playing through all discs.

### B - Pause

If you press the "volume" knob the disc is stopped, the unit is silent and "PAUSE" is displayed. To restart the disc press the knob again.

### C - To re-enter Radio mode

Push one of the waveband selector buttons.

### D - To re-enter Tape mode

If a cassette is already inserted, the tape deck will reengage if the "TAPE" button is pressed.

### E - To re-enter CD changer mode

If the CD changer function has been disconnected, the CD changer mode can be re-entered by pressing the "CHGR" button.

## Technical specifications

### SC-813

Power output:	4 x 25 W (10% dist.)
Output impedance:	4 Ohms
System voltage:	12 Volts, negative ground

### Radio

System: PLL (Phase Lock Loop) system with tuned RF (Radio Frequency) front and end automatic wide band gain control.  
Electronic suppression circuitry (noise killer).

This Radio is equipped with FM-Diversity.

### Frequency range:

AM	530 - 1710 kHz
FM	87.7 - 107.9 MHz

### Sensitivity:

AM	20 $\mu$ V
FM	1.1 $\mu$ V

**Stereo separation:** 35 dB

### Cassette deck

4-track, 2 channel stereo

Full logic electronic tape transport

Tape speed:	4.76 cm/sec.
Channel separation	53 dB
Frequency range	30-15000 hz
S/N (120 $\mu$ V)	56 dB without Dolby B NR
S/N (120 $\mu$ V)	66 dB with Dolby B NR
Wow and Flutter	< 0.06%
Pinch off	

Dolby noise reduction is manufactured under license from Dolby Laboratories Licensing Corporation.

“Dolby”, “Pro Logic” and the double-D symbol are trademarks of Dolby Laboratories Licensing Corporation. The Dolby Pro Logic Surround System is manufactured under licence from Dolby Laboratories Licensing Corporation.

## Audio system SC-816 (certain models)

The following pages describe the use of your SC-816

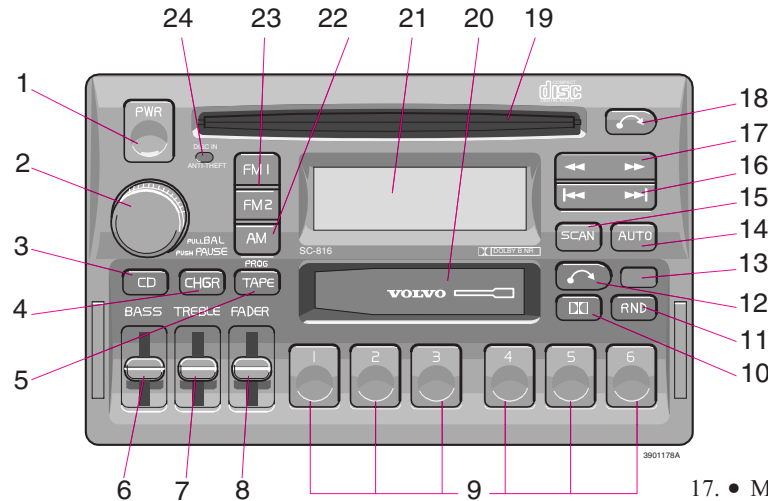

1. On/off (push)
2. • Volume (turn)
  - Pause/Mute (push)
  - Balance (pull)
3. Single CD mode selector - Active Sound Control
4. CD changer selector
5. • Tape mode selector
  - Tape direction selector PROG
6. Bass control
7. Treble control
8. Fader control

9. • Preset buttons
  - CD-Disc No. selector
10. Dolby B NR button
11. CD-random play
12. Cassette eject
13. Remote control window
14. Auto seek memory
15. Scan
16. • Seek tuning up/down
  - TP-Next/Previous song
  - CD-Next UP/Previous DOWN track

17. • Manual tuning
  - TP-fast forward/Rewind
  - CD-Music search UP/DOWN
18. CD eject (single)
19. CD slot
20. Cassette slot
21. Display
22. Waveband selector (AM)
23. Waveband selectors (FM)
24. • Anti-theft LED
  - Disc in LED (single)

TP = Applicable only in Tape Mode

CD = Applicable only when in CD mode and connected to a CD changer.

## Anti-theft code

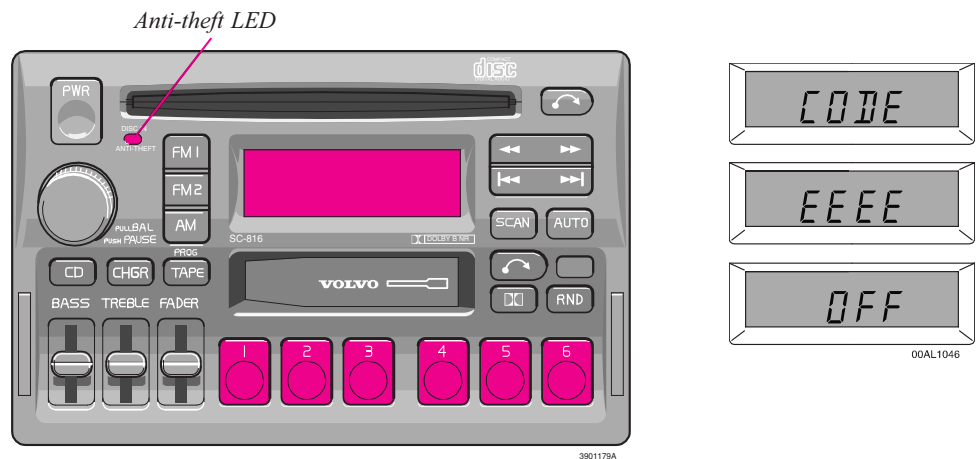

### Anti-theft code

The radio features anti-theft circuitry. If the set is removed from the vehicle or if the battery power is disconnected, a special code must be entered to enable operation of the set.

**Your Volvo retailer will supply you with this code.**

**NOTE:** Volvo recommends that you store the radio code in a safe place.

A red LED will flash when the key had been removed **from the ignition to confirm that the anti-theft circuitry has been activated.**

### To enter the code

After installation or when the set has been disconnected from power, the set displays "CODE" when it is switched on.

Enter the 4-digit code using the preset buttons.

If the correct code is entered the set is ready to use.

If you enter an incorrect code you must enter the correct code again from the beginning.

### Incorrect code

If an incorrect code has been entered "EEEE" is displayed. Enter the correct code. After three unsuccessful coding attempts the set will lock and remain locked for two hours. "OFF" is displayed.

During this waiting period:

- the battery must be connected
- the ignition key must be turned to position I
- the unit must be turned on

Make sure the headlights are turned off to help prevent battery drain (please refer to page 20 for information on turning the headlights off).

Enter the code again once this time has elapsed.

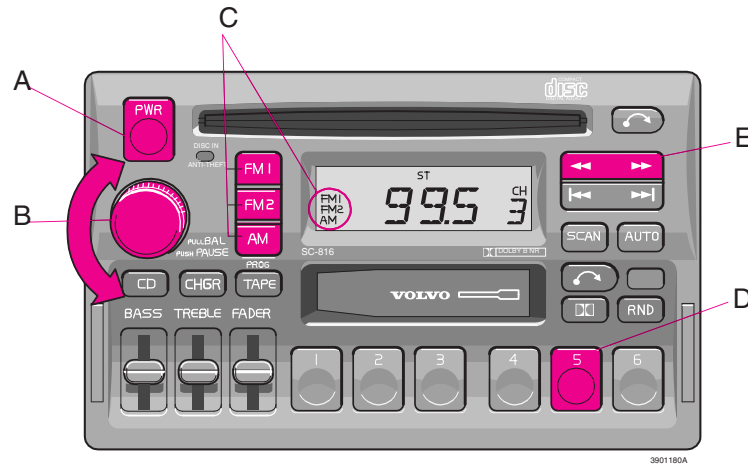

**A - On/off switch**

Push the button to switch on the radio. Press the button to turn the radio off.

**B - Volume control**

Turn the button clockwise to increase the volume. The volume control is electronic and has no end stop.

**C - Waveband selector**

The desired waveband is set by pressing one of the waveband selector buttons. The frequency and waveband is shown on the display.

**NOTE:** There are two FM wavebands and one AM waveband. This makes it possible to store 2 x 6 FM stations and 6 AM stations in the memory.

**D - Setting frequency selection**

The radio can be used in most parts of the world by changing the frequency selection intervals as follows:

Depress and hold preset button 5 and turn the radio ON. "USA" will flash on the display. Each time button 5 is pressed, the frequency selection will change from "USA" to "AUS", etc. When the correct country name is displayed, wait 5 seconds and the radio will be ready for use.

**E - Manual tuning**

Press the left side tune button to tune to lower frequencies and the right side to tune to higher frequencies. The tuned frequency is displayed.

**ST** will be displayed to indicate stereo FM reception.

## Radio SC-816

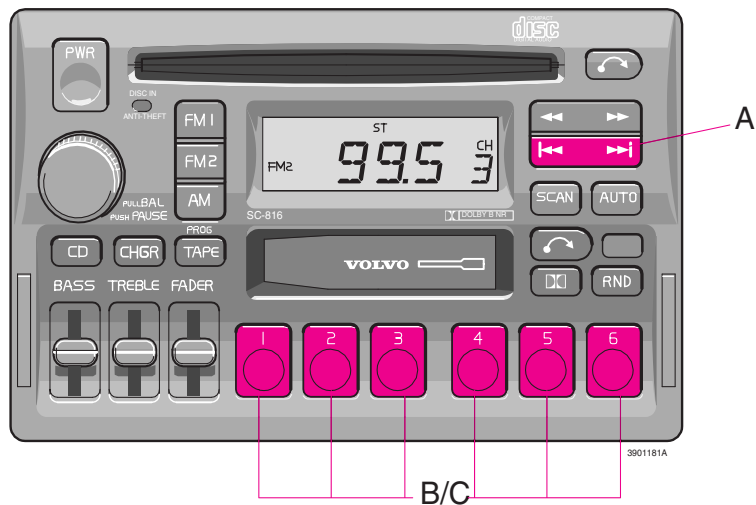

### A - Seek tuning up/down

Press the left side tune button to tune to lower frequencies and the right side to tune to higher frequencies. The radio seeks the next audible station and stops there. If you wish to continue the seek tuning, press the tune button again.

### B - Preset programming

1. Tune to the desired frequency.
2. Depress and hold a preset button. The audio will cut out. Keep the button depressed until the audio comes on again (approx. 2 seconds).
3. The frequency is now stored on this preset button.

### C - Preset buttons

To select a pre-programmed radio frequency, depress the preset button. The set frequency will be displayed.

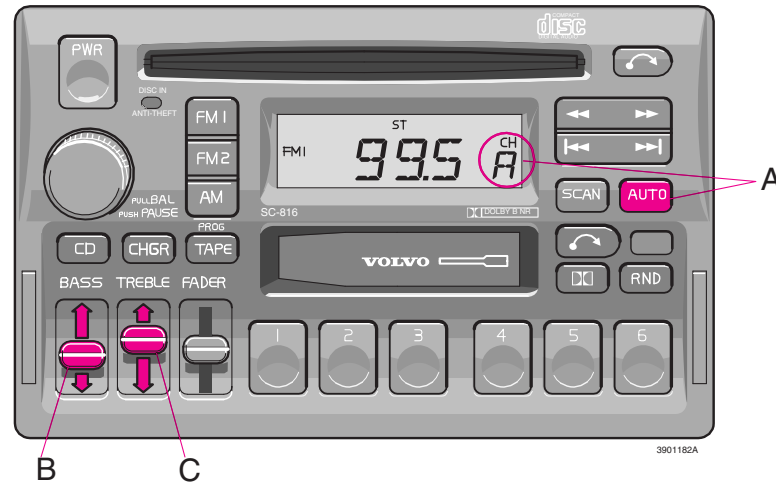

### A - Automatic programming (Auto)

Please note that this function will not interfere with pre-stored stations on buttons 1-6.

This function automatically seeks and stores up to 8 strong AM or FM stations.

This is especially useful when travelling in areas where radio stations are unfamiliar.

1. Depress and hold the "AUTO" button for **at least 1 second**. A number of strong stations (max. 8) on the chosen waveband are now automatically stored in the memory.

The lowest frequency station is heard. If there are no audible stations, "- - - -" is displayed.

2. Press the "AUTO" button (**for less than 1 second**) to obtain another autostored station.

A new station will be selected each time the button is pressed momentarily.

### B - Bass control

Adjust the bass by sliding the control up or down (up to increase, down to decrease).

A "detent" indicates "equalized" bass.

### C - Treble control

Adjust the treble by sliding the control up or down (up to increase, down to decrease).

A "detent" indicates "equalized" treble.

## Radio SC-816



### A - Fader control

Adjust front/rear speaker balance by sliding the control up or down.

(Up to direct more sound to the front speakers, down to direct more sound to the rear speakers.)

The "detent" indicates "equalized" front /rear balance position.

### B - Pause function

Press the "volume" knob to temporarily mute the sound. "PAUSE" is displayed.

### C - Balance control

Pull out the "volume" knob and adjust the left/right balance by turning the knob counter-clockwise or clockwise.

### D - Scan

Press this button to listen to each station for five seconds. Press it again to stop scanning.

### E - Active sound control (ASC)

The ASC function automatically adjusts the volume level of the audio system according to driving speed.

To deactivate ASC depress the "CD" button until "ASC" is no longer displayed.

To activate ASC, depress the "CD" button until "ASC" is displayed (approx. 2 seconds).



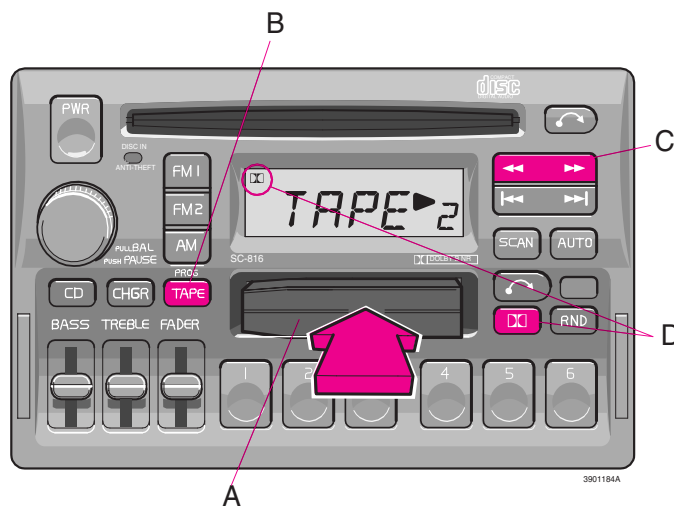

### A - Cassette slot



The cassette is inserted with the open side to the right (side 1 or A of the cassette upwards).

When the cassette is inserted, the radio is disengaged and the cassette will start to play automatically. "TAPE ▷" or "TAPE ◁" is displayed to indicate which side of the tape is being played. When one side of the tape has been played the unit will automatically play the other side (auto-reverse). The cassette can be inserted or ejected even when the unit is switched off.

### B - Reversing the tape (PROG)

Press the button to play the other side of the tape.

### C - Fast winding

The tape is advanced with  and rewind with . "FF" will be displayed while advancing the tape. "REW" will be displayed while rewinding the tape.

Fast winding can be stopped by pressing the tuning button or the TAPE button again.

### D - Dolby B NR button

Press this button when you use tapes recorded with the Dolby B noise reduction system.

The Dolby symbol  will be indicated in the display.

## Cassette deck



### A - Next selector

Press the  button and the tape will automatically advance to the next song.

There must be a gap (no audio sound) of approx. 5 seconds between songs for this function to operate.

### B - Previous selector

Press the  button and the tape will automatically rewind to the previous song.

There must be a gap (no audio sound) of approx. 5 seconds between songs for this function to operate.

### C - Pause

If you press the "volume" knob the tape is stopped, the unit is silent and "PAUSE" is displayed. To restart the tape press the knob again.

### D - Scan

Press this button to listen to the first five seconds of each song. Press it again to stop scanning. "SCAN" will be displayed. There must be a gap (no audio sound) of approx. 5 seconds between songs for this function to operate.



### A - Cassette eject

If the button is pressed the tape will stop and the cassette will be ejected. The radio will be automatically engaged. The radio, CD or CD changer will engage automatically (depending on which mode was activated before the tape was played).

### B - To re-enter Radio mode

Push one of the waveband selector buttons  
When the unit re-enters Radio mode, the cassette will not be ejected.

### C - To re-enter Tape mode

If the Tape function has been disconnected and the cassette has not been ejected, the Tape mode can be re-entered by pressing the "TAPE" button.

### D - To re-enter CD mode

If the CD function has been disconnected and the CD has not been ejected, the CD mode can be re-entered by pressing the "CD" button.

### E - To re-enter CD changer mode

If the CD changer function has been disconnected, the CD changer mode can be re-entered by pressing the "CHGR" button.

## CD - Single

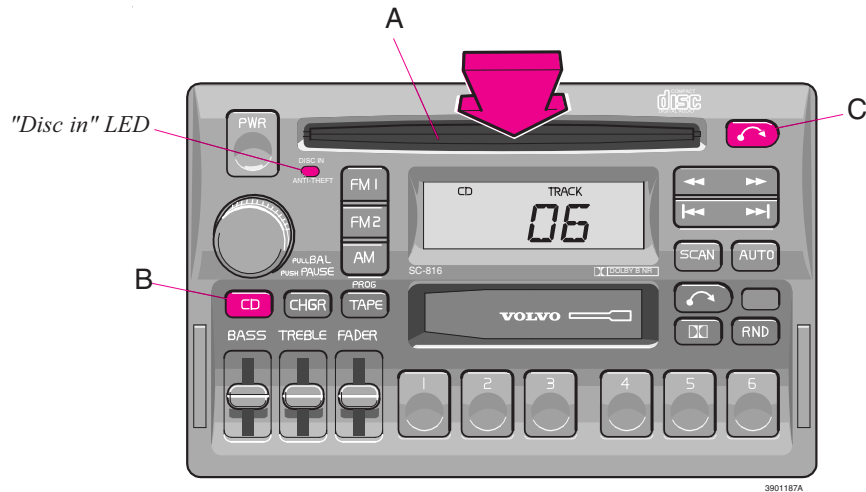

### A - CD slot

With the audio system on, insert a disc into the slot with the label side up. When the CD is inserted, the radio is disengaged and the CD will start to play automatically.

The CD can be inserted or ejected even when the unit is switched off.

When the CD has been inserted into the player, the "DISC IN" light will always be ON even if the radio, tape deck or CD changer are in use.

### B - CD mode selector

Press "CD" to actuate the CD mode. The track last listened to will continue to play. If the CD-player is empty, "NO CD" will be displayed.

### C - CD eject

If the button is pressed the CD will stop and the disc will be ejected. The radio will be automatically engaged. The radio, tape or CD changer will engage automatically (depending on which mode was activated before the CD was played).

**NOTE:** If the CD eject button is pressed and the disc is not removed within 12 seconds, the disc will be drawn into the CD player again.



### A - Music search

Press the or button to search within a track. While the button is depressed the playing time for this track will be displayed.

### B - Changing the selected track number

Press for forward selection or for backward selection. The disc number and the chosen track number will be displayed.

### C - Playing-time display

When the "CD" button is pressed the playing time for the current track is displayed for 5 seconds.

### D - Scan

Press this button to listen to the first ten seconds of each track. Press it again to stop scanning.

## CD - Single

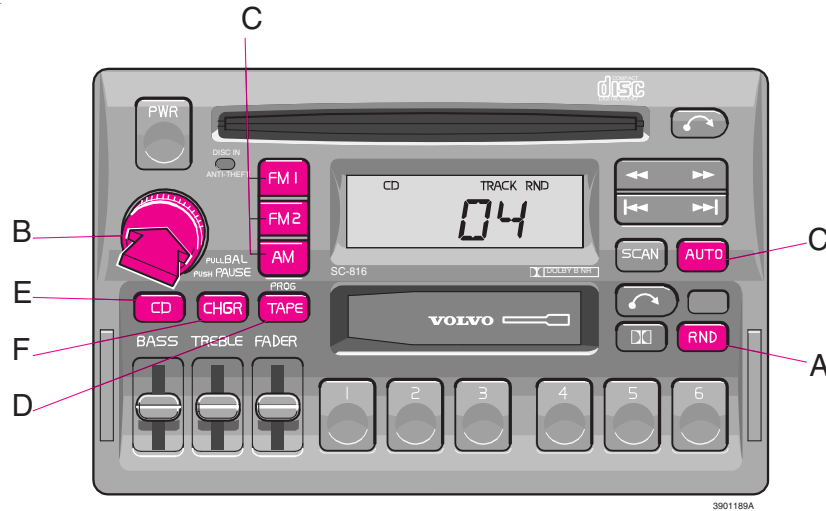

### A - Random choice

Press "RND" to actuate the random mode. From a disc, tracks will be played at random\*. "RND" will be displayed when this function is engaged.

\* The random function may cause a disc to be played more than once before playing through all discs.

### B - Pause

If you press the "volume" knob the disc is stopped, the unit is silent and "PAUSE" is displayed. To restart the disc press the knob again.

### C - To re-enter Radio mode

Push one of the waveband selector buttons

### D - To re-enter Tape mode

If a cassette is already inserted, the tape deck will reengage if the "TAPE" button is pressed.

### E - To re-enter CD mode

If the CD function has been disconnected and the CD has not been ejected, the CD mode can be re-entered by pressing the "CD" button.

### F - To re-enter CD changer mode

If the CD changer function has been disconnected, the CD changer mode can be re-entered by pressing the "CHGR" button.

## CD - Changer (retailer option)

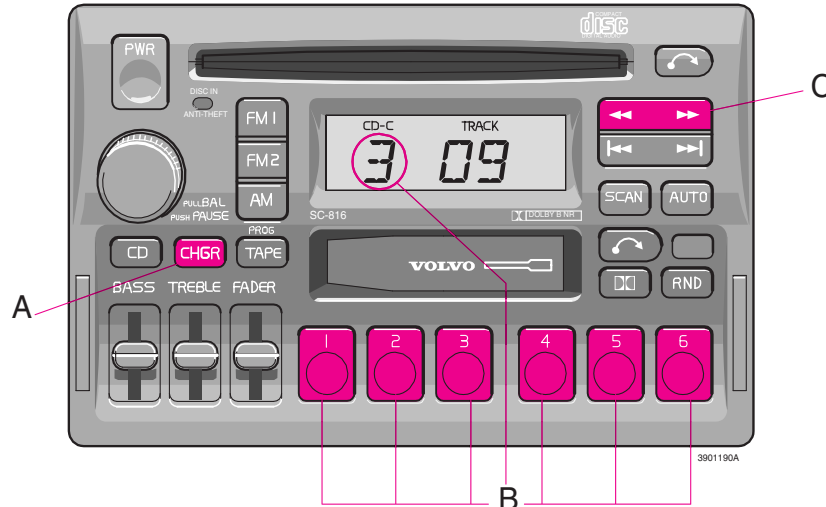

### A - CD changer mode selector

Press "CHGR" to actuate the CD changer mode. The disc/track last listened to will continue to play. If the CD-changer cartridge\* is empty, "0-00" will be displayed. If there is no cartridge in the changer "- - -" will be displayed. If a selected disc does not exist, the disc number and "-00" will be displayed and the next disc will be automatically selected.

\*The functions pertaining to the CD-changer are only applicable if the unit has been connected to the Volvo CD-changer, which is sold separately as an accessory.

If no CD-changer is connected to the unit "EEEE" will be displayed if you happen to choose CHGR mode.

### B - Disc number selector

Depress one of the preset buttons (1-6) to select the disc number desired. The selected disc number and track number will be displayed.

### C - Music search

Press the ◀◀ or ▶▶ button to search within a track. While the button is depressed the playing time for this track will be displayed.

## CD - Changer (retailer option)

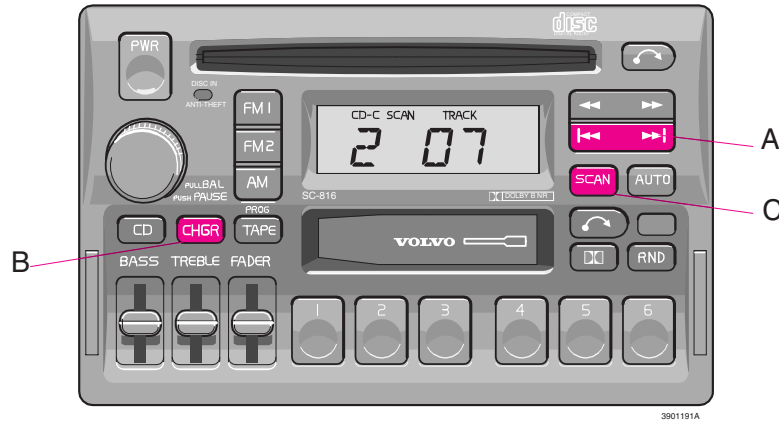

### A - Changing the selected track number

Press **FM1** for forward selection or **FM2** for backward selection. The chosen disc number and track number will be displayed.

### B - Playing-time display

When the "CHGR" button is pressed the playing time for the current track is displayed for 5 seconds.

### C - Scan

Press this button to listen to the first ten seconds of each track. Press it again to stop scanning.



## CD - Changer (retailer option)

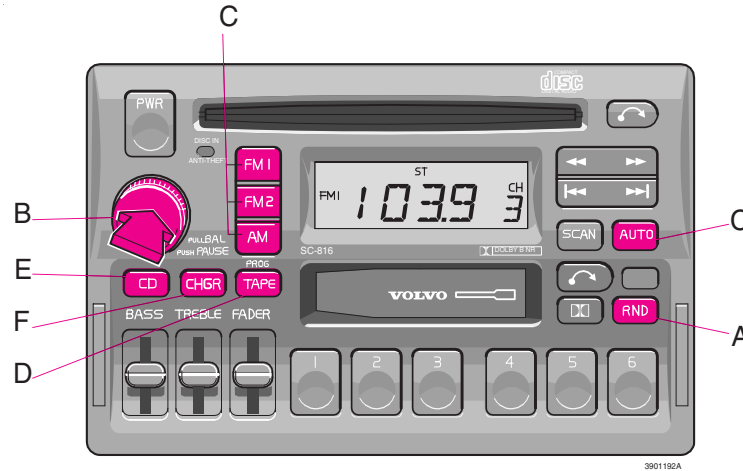

### A - Random choice

Press "RND" to actuate the random mode. From a disc chosen at random, 4 tracks will be played (also chosen at random). A new disc will then be played in the same way. "RND" will be displayed when this function is engaged.

### B - Pause

If you press the "volume" knob the disc is stopped, the unit is silent and "PAUSE" is displayed. To restart the disc press the knob again.

### C - To re-enter Radio mode

Push one of the waveband selector buttons.

### D - To re-enter Tape mode

If a cassette is already inserted, the tape deck will reengage if the "TAPE" button is pressed.

### E - To re-enter CD mode

If the CD function has been disconnected and the CD has not been ejected, the CD mode can be re-entered by pressing the "CD" button.

### F - To re-enter CD changer mode

If the CD changer function has been disconnected, the CD changer mode can be re-entered by pressing the "CHGR" button.

## Technical specifications

### SC-816

Power output:	4 x 60 W (10% dist.)
Output impedance:	4 Ohms
System voltage:	12 Volts, negative ground

### Radio

System: PLL (Phase Lock Loop) system with tuned RF (Radio Frequency) front and end automatic wide band gain control. Electronic suppression circuitry (noise killer).

The Radio is equipped with FM diversity.

### Frequency range:

AM	530 - 1710 kHz
FM	87.7 - 107.9 MHz

### Sensitivity:

AM	20 $\mu$ V
FM	1.1 $\mu$ V

**Stereo separation:** 35 dB

### Cassette deck

4-track, 2 channel stereo

Full logic electronic tape transport

Tape speed:	4.76 cm/sec.
Channel separation	53 dB
Frequency range	30-15000 hz
S/N (120 $\mu$ V)	56 dB without Dolby B NR
S/N (120 $\mu$ V)	dB with Dolby B NR
Wow and Flutter	< 0.06%
Pinch off	

Dolby noise reduction is manufactured under license from Dolby Laboratories Licensing Corporation.

“Dolby”, “Pro Logic” and the double-D symbol are trademarks of Dolby Laboratories Licensing Corporation. The Dolby Pro Logic Surround System is manufactured under licence from Dolby Laboratories Licensing Corporation.

## Audio system SC-901 (certain models)

The following pages describe the function and operation of your SC-901.

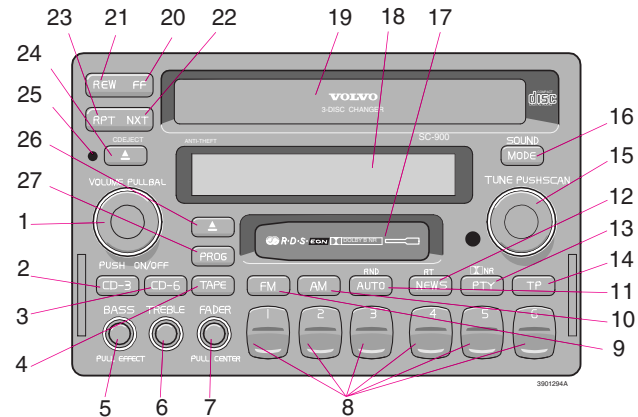

- |   |   |  |
|---|---|--|
| <ol style="list-style-type: none"> <li>1. On/off (press)             <ul style="list-style-type: none"> <li>• Volume (turn)</li> <li>• Balance (pull out and turn)</li> </ul> </li> <li>2. CD player - on/off</li> <li>3. CD mode selector - on/off</li> <li>4. Cassette deck - on/off</li> <li>5.             <ul style="list-style-type: none"> <li>• Bass control</li> <li>• Volume control - sound effects (pull and turn)</li> </ul> </li> <li>6. Treble control</li> <li>7.             <ul style="list-style-type: none"> <li>• Balance control front/rear (fader)</li> <li>• Volume control - center speaker (pull and turn)</li> </ul> </li> <li>8. Preset buttons             <ul style="list-style-type: none"> <li>• CD 3 disc selector 1-3</li> <li>• CD 6 disc selector 1-6</li> </ul> </li> <li>9. Waveband selector (FM)</li> </ol> | <ol style="list-style-type: none"> <li>10. Waveband selector (AM)</li> <li>11.             <ul style="list-style-type: none"> <li>• Autostore memory</li> <li>• CD - random play</li> </ul> </li> <li>12.             <ul style="list-style-type: none"> <li>• News</li> <li>• Radio text</li> </ul> </li> <li>13.             <ul style="list-style-type: none"> <li>• Program type selector</li> <li>• Dolby B noise reduction</li> </ul> </li> <li>14. Traffic information selector</li> <li>15.             <ul style="list-style-type: none"> <li>• Manual tuning knob</li> <li>• Track selector - CD</li> <li>• Scanning</li> </ul> </li> <li>16. Pro Logic Surround Sound</li> <li>17. Cassette slot</li> <li>18. Display</li> <li>19. CD slot</li> <li>20. Fast forward             <ul style="list-style-type: none"> <li>• CD - forward search</li> </ul> </li> </ol> | <ul style="list-style-type: none"> <li>• Tape - forward search</li> <li>• Radio - frequency up</li> </ul> <ol style="list-style-type: none"> <li>21. Fast rewind             <ul style="list-style-type: none"> <li>• CD - backwards search</li> <li>• Tape - backwards search</li> <li>• Radio - frequency down</li> </ul> </li> <li>22. CD - next track             <ul style="list-style-type: none"> <li>• Tape - next track</li> <li>• Radio - next station (seek up)</li> </ul> </li> <li>23. CD - repeat previous track             <ul style="list-style-type: none"> <li>• Tape - repeat previous track</li> <li>• Radio - next station (seek down)</li> </ul> </li> <li>24. CD - open</li> <li>25.             <ul style="list-style-type: none"> <li>• Anti-Theft indicator</li> <li>• CD - warning indicator</li> </ul> </li> <li>26. Cassette eject</li> <li>27. PROG - reversing the tape</li> </ol> |
|---|---|--|

## Anti-theft code

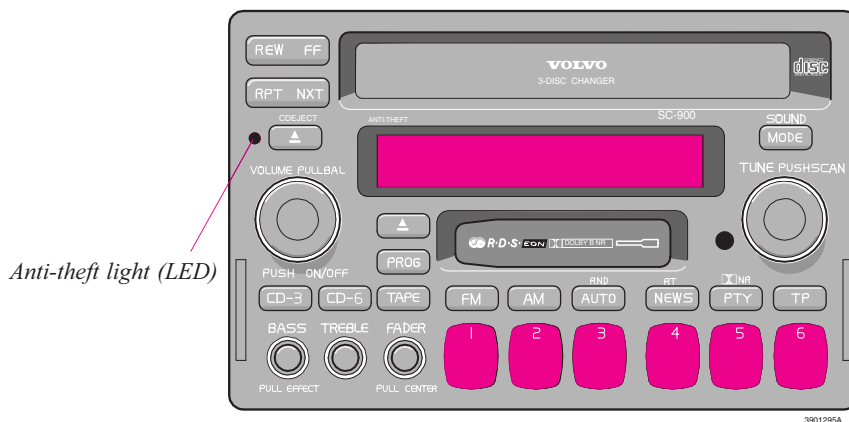

### Anti-theft code

The radio features anti-theft circuitry. If the set is removed from the vehicle or if the battery power is disconnected, a special code must be entered to enable operation of the set.

**Your Volvo retailer will supply you with this code.**

**NOTE:** Volvo recommends that you store the radio code in a safe place.

A red LED will flash when the key had been removed **from the ignition to confirm that the anti-theft circuitry has been activated.**

### To enter the code

After installation or when power has been disconnected, 'CODE' appears in the display when the set is switched on.

Enter the 4-digit code using the preset buttons. If the correct code is entered, the set is ready to use.

If you enter an incorrect code, you must enter the correct code again from the beginning.

### Incorrect code

If an incorrect code has been entered, 'CODE Repeat' is displayed. Enter the correct code. After three unsuccessful coding attempts, the set will lock and remain locked for two hours. 'System Off' appears in the display.

During this waiting period:

- the battery must be connected
- the ignition key must be turned to position I
- the unit must be turned on

Make sure the headlights are turned off to help prevent battery drain (please refer to page 20 information on turning the headlights off).

Enter the correct code after the two hours have elapsed.

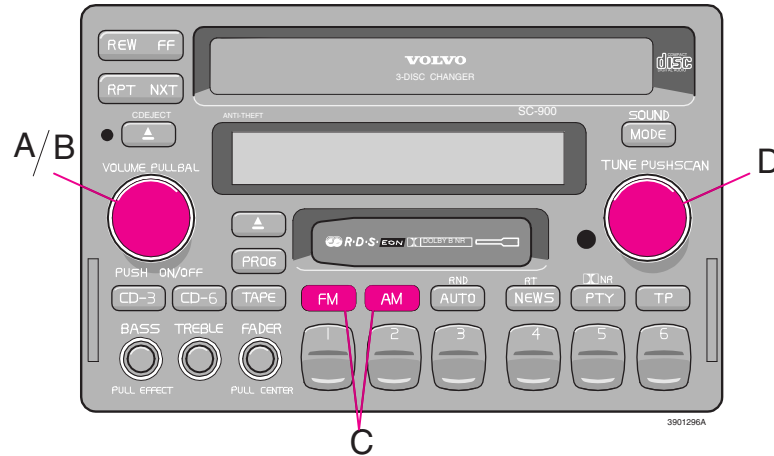

**A - On/off switch**

Press the button to switch the radio on/off.

**B - Volume control**

Turn this knob clockwise to increase the volume. The volume control is electronic and has no stop point.

**C - Waveband selector**

Press the "FM" or "AM" button to select the waveband you require. The name of the station and the waveband will appear in the display.

**NOTE:** There are three FM bands and one AM band. This allows you to store 3 x 6 FM stations and 6 AM stations. By pressing the **FM** button repeatedly you can switch between FM 1, FM 2 and FM 3.

**D - Manual tuning knob**

Turn this knob clockwise to select higher frequencies and counterclockwise for lower frequencies. Stored frequencies appear in the display.

## Radio SC-901

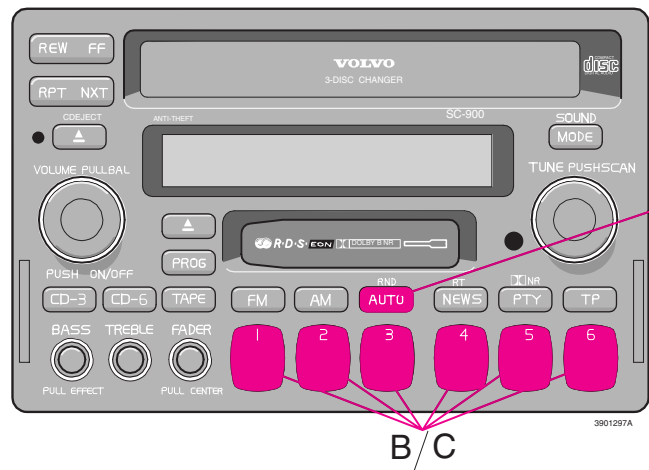

### A - Automatic programming of stations

**Please note that this function will not interfere with pre-stored stations on buttons 1-6.**

This function automatically seeks and stores up to 10 strong AM or FM stations in a separate memory. This is especially useful when travelling in areas where radio stations are unfamiliar.

1. Press and hold the 'AUTO' button for at least one second. A number of strong stations (max. 10) on the chosen waveband are now automatically stored in the memory. An 'A' now appears to the right in the

display. If there are no sufficiently strong signals, 'No Station' is displayed.

2. Press the 'AUTO' button (for less than one second) if you want to change to one of the other auto-stored stations. A new auto-stored station will be selected each time the button is pressed.

### B - Preset programming

1. Tune to the desired frequency.
2. Press a preset button (the audio will cut out) and keep it pressed until the audio comes on again (approximately two seconds).
3. The frequency is now stored on this preset button.

### C - Preset buttons

To select a preprogrammed radio program, press the appropriate preset button. The stored program will appear in the display.

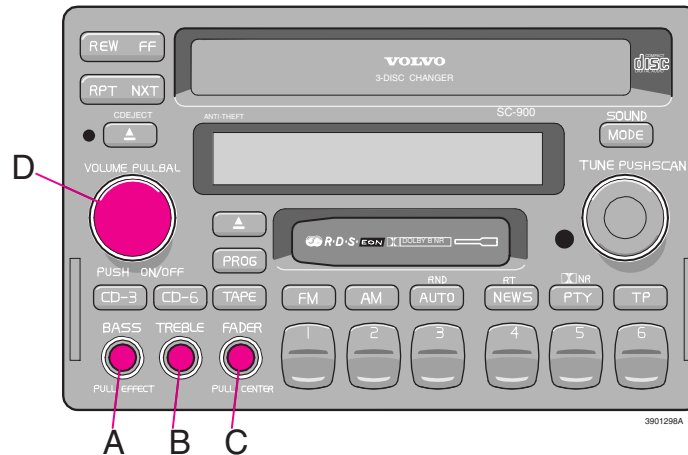

### A - Bass control

Adjust the bass by pressing the button to extend the control and then turning it to the left (less bass) or to the right (more bass). A "detent" indicates "equalized" bass. Press the button back in when you have set the level.

### B - Treble control

Adjust the treble by pressing the button to extend the control and then turning it to the left (less treble) or to the right (more treble). A "detent" indicates "equalized" treble. Press the button back in when you have set the level.

### C - Fader - Balance control front/rear

Adjust front/rear speaker balance by pressing the button to extend the control and then turning it to the left (more sound from the front speakers) or to the right (more sound from the rear speakers). A "detent" indicates "equalized" balance. Press the button back in when you have set the level.

### D - Balance control right/left

Pull out the 'volume' button and turn clockwise/counterclockwise to adjust the balance between the right/left speakers. The balance is shown in the display.

## RBDS, Automatic tuning

### Radio Broadcast Data System - (RBDS)

The SC-901 radio is equipped with an advanced system allowing information from broadcasters to be transmitted inaudibly together with the audio signal. This information is then decoded by the SC-901 and made available for several new and unique features. The RBDS or Radio Broadcast Data System operates in the FM band only, and the information transmitted is supplied by participating broadcasters. Volvo has no control over the accuracy of the data or information. Please refer to pages 175-179 regarding specific descriptions and operation of these functions.

Volvo was among the first to pioneer this technology throughout Europe and it is slowly making its way to North America. Coverage by local broadcasters may be limited at this time, but as the technology and benefits grow, you will find the SC-901 radio ready to take advantage of this system.

### Automatic tuning

This feature may not apply in your area.

If you tune into a station using RBDS, the frequency is displayed followed by the name of the station in letters. The AF function ensures that the radio automatically tunes into the most **powerful** transmitter for the selected program.

Keep the **FM** button pressed down for at least two seconds. 'AF Switch OFF' appears in the

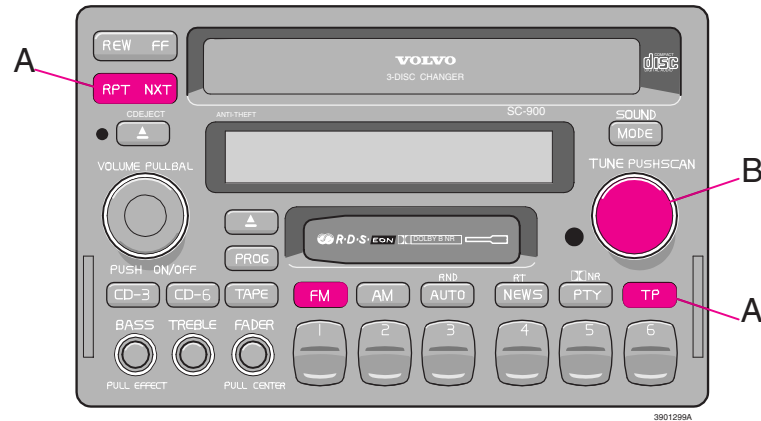

display for two seconds. If you want to switch on the AF function, press the **FM** button for less than one second. 'AF Switch ON' then appears in the display.

**'AF Switch ON'**- Automatic station tracking is activated

**'AF Switch OFF'**- Automatic station tracking is deactivated

### A - Station seek up/down

Press the left side of the station seek button to seek for lower frequencies and the right side for higher frequencies. The radio seeks the next audible station and stops there. Press the button again to continue searching.

If the **TP** button is depressed, the station seek function will only seek stations which broadcast this particular type of program. Press the button to switch off this function.

### B - Scanning

Press this button to listen to each station for 8 seconds. If the unit is in tape or CD mode, each track will play for ten seconds.



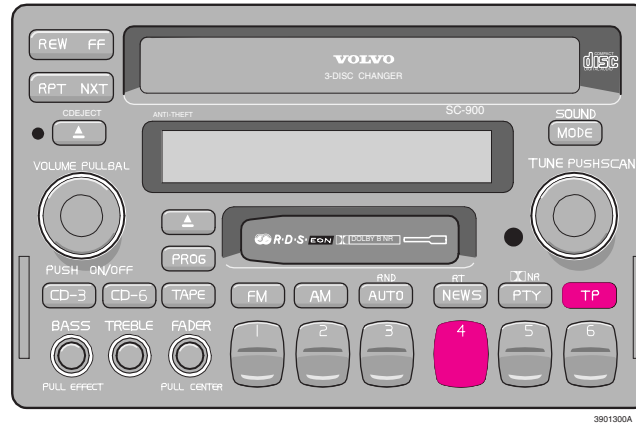

## Traffic Program (TP)

**This feature may not apply in your area and only functions with FM broadcasts. Please refer to the RBDS information on page 174.**

By pressing the **TP** button, RBDS stations broadcasting traffic information can be heard. 'TP' is displayed when this function is switched on. If the unit is in tape or CD mode when the radio receives traffic information, the respective function will be interrupted and the announcement is received at the volume selected for traffic information.

As soon as the announcement is over, the previous volume will be restored and the tape or CD will start to play again.

- Traffic information can only be received when TP is displayed.
- If TP is flashing, it means that either no traffic information is being broadcast by the current transmitter or the signal is too weak. After approximately 70 seconds, an audible signal will be heard, indicating that you should change to a stronger TP transmitter. To turn off this signal:
  - Turn the radio off
  - Press and hold down the **TP** button and turn the radio on. By pressing the **TP** button again, you can turn the TP alarm on or off.

- The radio will function normally again after 5 seconds.
- Press the **TP** button again if you want to stop listening to a traffic announcement.

## News

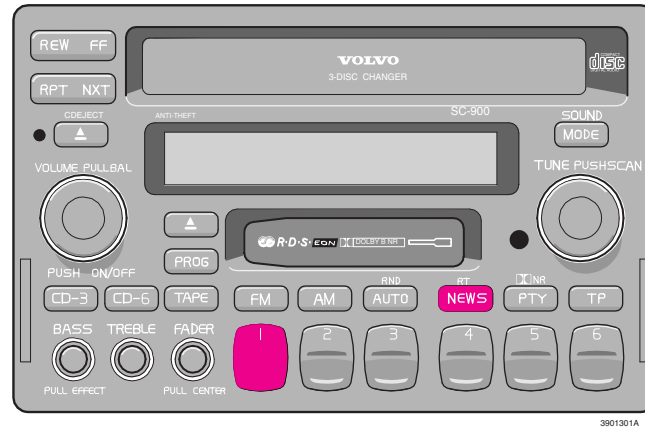

### NEWS

**This feature may not apply in your area and only functions with FM broadcasts. Please refer to the RBDS information on page 174.**

Press the **NEWS** button to seek a station broadcasting news programs.

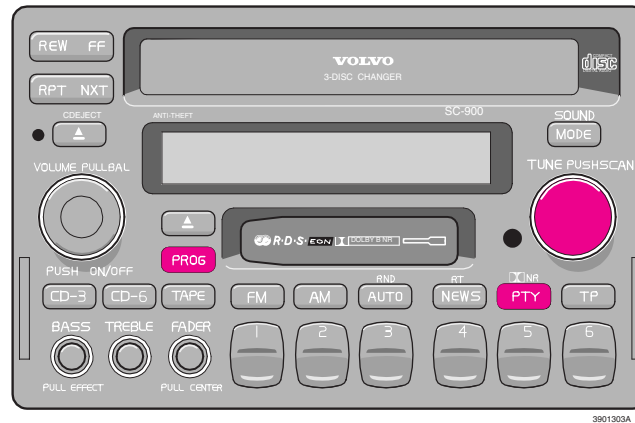

### Program type

The 'PTY' function enables you to select different types of program. If you want to search for a specific program type:

1. Press the **PTY** button for less than 1 second.  
The program type of the currently selected radio station will be displayed.
2. By turning the manual tuning knob, it is possible to scroll through the different program types.
3. When you have found a program type you want to select, press the manual tuning knob to begin the search. During the search, the chosen program type will flash in the display.

4. If the radio finds a station of the selected program type, it will tune in this station and the station's name will appear in the display. If no station with the selected program type is found, 'No PTY' will appear in the display for five seconds and the radio will revert to the previous station.

**For general information on RBDS functions, please refer to page 174.**

## PTY preset buttons

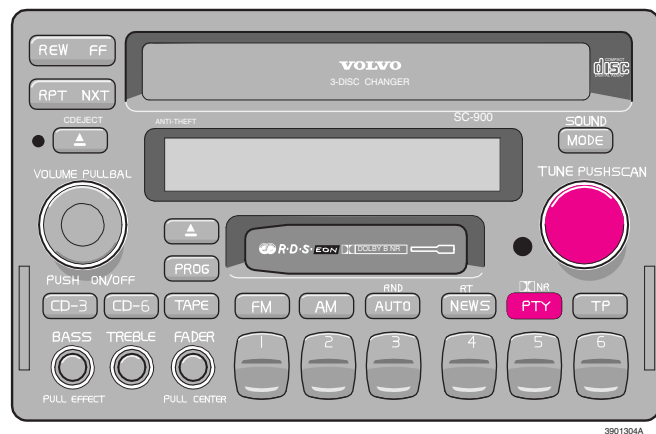

### PTY preset buttons

Program types are factory-preset as follows:

Button 1 - Top 40

Button 2 - Classical

Button 3 - News

Button 4 - Rock

Button 5 - R&B

Button 6 - Country

These settings can be reprogrammed according to your preferences. To change the default settings:

1. Press the **PTY** button for less than 1 second to enter the PTY preset programming mode.

2. Turn the manual tuning knob to display different program types.
3. Press one of the preset buttons for at least 2 seconds to store your choice of program type on that button.

### Using the PTY preset buttons

Press one of the preset buttons to select a program type. The program type stored on that button will be displayed and a station broadcasting that type of program will be selected. Press the same button again to select a new station broadcasting the same type of program.

**For general information on RBDS functions, please refer to page 174.**

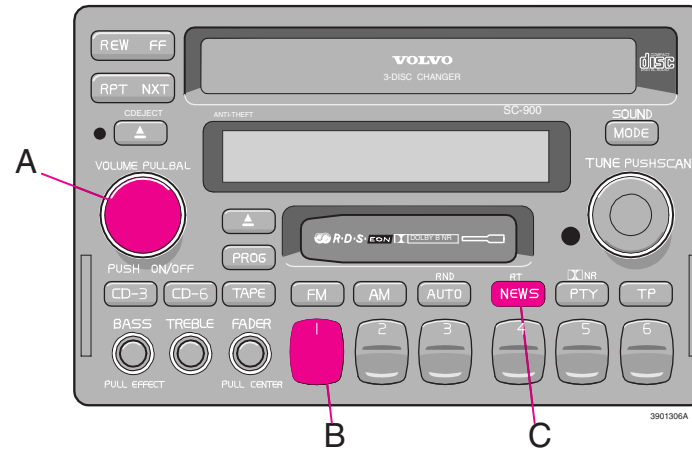

### A - Volume for traffic information

If you change the volume during a traffic announcement, this volume setting will be stored automatically and used for future traffic information.

### B - Automatic volume control

The Auto Volume function adjusts both the volume and frequency response according to vehicle speed.

To enable/disable (switch on or off) this function:

- Hold down **preset button 1** while switching on the radio. The current setting (ON or OFF) will be displayed.
- Press preset button 1 to toggle between ON and OFF. After five seconds, the display will return to normal and your selection (ON or OFF) will be stored.

### C - Radio Text (RT)

Certain RBDS stations broadcast general information on programs, music, weather, etc. in text form.

This information can be displayed by pressing the **NEWS** button for approximately 2 seconds. If no text information is available, "No radio text" will be displayed.

#### **WARNING!**

The Radio Text function should not be used by the driver while the car is in motion as this could create a traffic hazard.

**For general information on RBDS functions, please refer to page 174.**

## Cassette deck

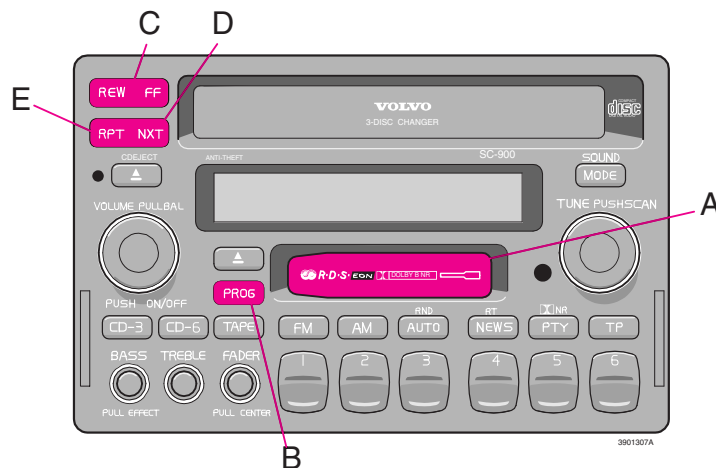

### A - Cassette slot

Insert the cassette with the open side to the right (side 1 or A upwards). When the cassette is inserted, the radio is automatically switched off and the cassette will start to play. 'Tape side A' or 'Tape side B' will appear in the display to indicate which side of the tape is being played. When one side of the tape has been played, the unit will automatically play the other side (auto-reverse). The cassette can be ejected up to five minutes after the key has been taken out of the ignition.

### B - Reversing the tape (PROG)

Press this button if you want to play the other side of the tape. The side of the tape being played will be displayed.

### C - Fast winding

The tape is advanced with 'FF' and rewind with 'REW'. 'FF' (fast forward) or 'REW' (rewind) appear in the display when fast winding. Fast winding can be stopped by pressing the button again.

### D - Next track

If you press the 'NXT' button, the tape will automatically advance to the next track. There must be a gap (no audio sound) of approx. 5 seconds between songs for this function to operate.

### E - Previous track

If you press the 'RPT' button, the tape will automatically rewind to the previous track. There must be a gap (no audio sound) of approx. 5 seconds between songs for this function to operate.

'NXT' and 'RPT' flash when the tape is either fast forwarding or rewinding.

**NOTE:** This radio is equipped with background FF/REW and NXT/RPT functions. This means that you can listen to the radio or a CD by selecting either of these modes while a tape is being wound.

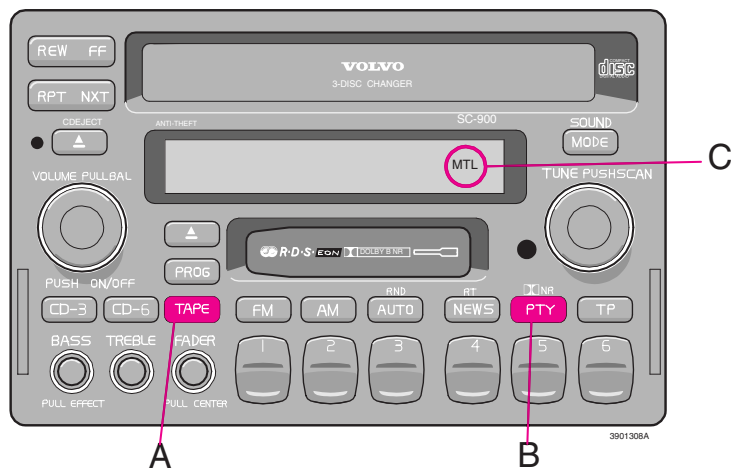

### A - Pause

If you press the **'TAPE'** button, the tape will stop, the sound will cut off and **'PAUSE'** will appear in the display. Press the **'TAPE'** button to restart the tape.

### B - Dolby B noise reduction

Press this button if you are playing a tape which has been recorded with the Dolby B noise reduction system. The Dolby symbol  appears in the display.

### C - Metal tapes

If you are playing a metal tape (CrO<sub>2</sub>) **'MTL'** appears in the display.

## Cassette deck

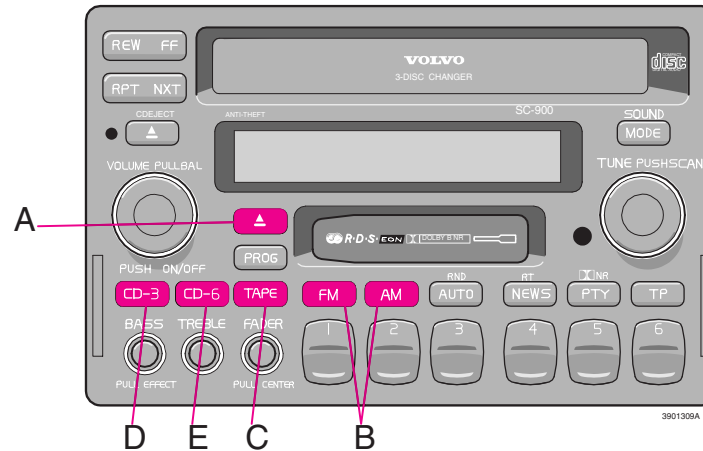

### A - Cassette eject

If you press this button, the tape will stop and the cassette will be ejected. The radio, CD 3 player or CD 6 changer will be automatically switched on depending on which mode was used before the tape was played.

### B - To return to the radio mode

Press the FM, AM or AUTO button to return to the radio mode. The radio will then be switched on without the cassette being ejected.

### C - To return to the tape mode

If the cassette deck has been switched off, but the cassette has not been ejected, you can return to tape mode by pressing the 'TAPE' button.

### D - To return to the CD 3 mode

If the CD player has been switched off, but the cartridge has not been ejected, you can return to the CD 3 mode by pressing the CD 3 button.

### E - To return to the CD 6 changer mode

If the CD 6 changer has been switched off, you can return to the CD 6 changer mode by pressing the CD 6 button.



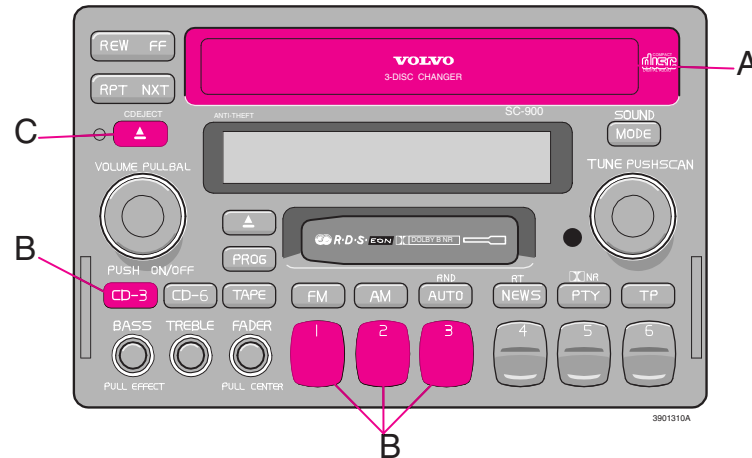
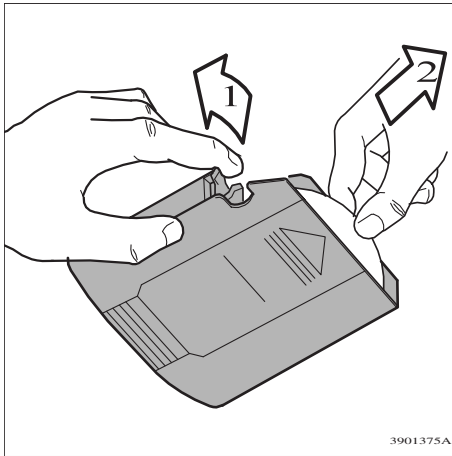

### A - CD 3-slot

When you insert a cartridge, the unit will automatically switch modes and the CD 3 will start playing. A cartridge can be inserted even if the unit is switched off. **To operate:**

- Insert the discs into the cartridge, label side up.
- Insert the cartridge in the CD 3 slot, in the direction indicated by the arrow on the top side of the cartridge.
- Eject the cartridge by pressing button C.
- Remove the discs from the cartridge by pulling the lock tab for the disc you wish to remove (1). Carefully pull the disc out of the cartridge (2).

### B - CD 3 player mode - on

Press the CD 3 button to activate the CD player. The last track to be played will start playing. If there is no disc in the cartridge, the cartridge will automatically be ejected. Choose disc 1, 2 or 3 with the preselect buttons 1-3.

### C - CD 3 eject

If you press this button, the CD 3 player will stop and the cartridge will be ejected. The radio, cassette deck or CD 6 changer will automatically be switched back on, depending on which function was used last.

**NOTE:** Do not pull the cartridge while it is in operation, as this may damage the mechanism.

## CD 3 player

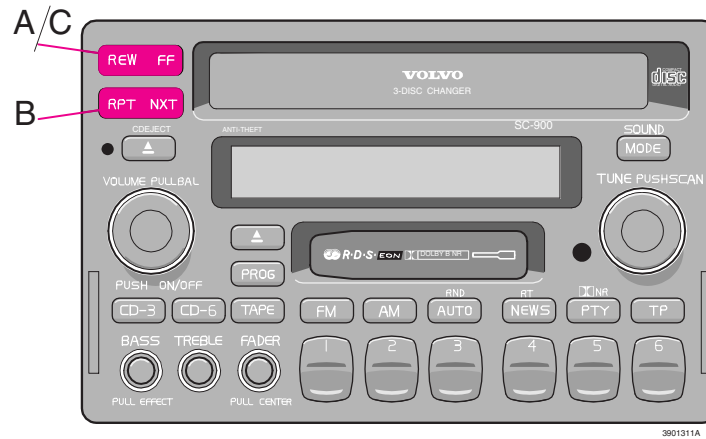

### A - Music search

Press the 'FF' or 'REW' buttons to search within a track. While the button is pressed, the playing time for this track is displayed.

### B - Changing tracks

Press 'NXT' to move forward to the next track, 'RPT' to repeat the previous track or turn the manual tuning knob. The selected disc number and track number will appear in the display.

### C - Playing-time display

When the 'FF' or 'REW' buttons are pressed, the playing time for the current track is displayed for 5 seconds.

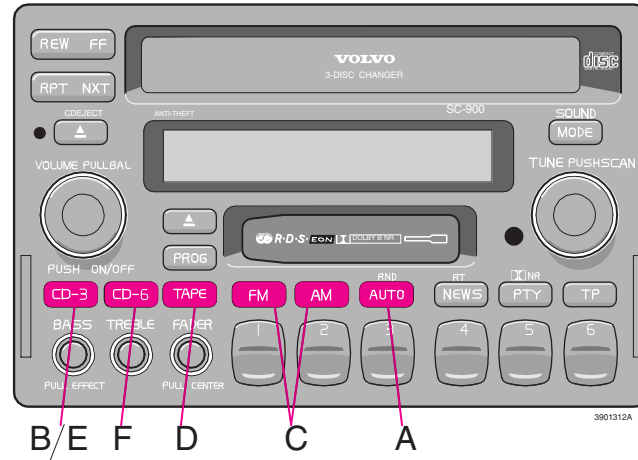

### A - Random choice

Press 'RND' to activate the random function. The unit will play the tracks on the disc in a random\* order. 'RND' (random) appears in the display while the function is on.

\* The random function may cause a disc to be played more than once before playing through all discs.

### B - Pause

If you press the **CD 3** button, the CD 3 player stops, the sound is switched off and 'Pause' appears in the display. Press the CD 3 button again to restart the CD 3 player.

### C - To return to the radio mode

Press the **FM** or the **AM** button.

### D - To return to the tape mode

If a cassette is already inserted, you can return to tape mode by pressing the 'TAPE' button.

### E - To return to the CD 3 mode

If the CD 3 player has been switched off but the cartridge has not been ejected, you can return to the CD 3 mode by pressing the **CD 3** button.

### F - To return to the CD 6 changer mode

If the CD 6 changer has been switched off, you can return to the CD changer mode by pressing the **CD 6** button.

## CD 6 changer (retailer option)

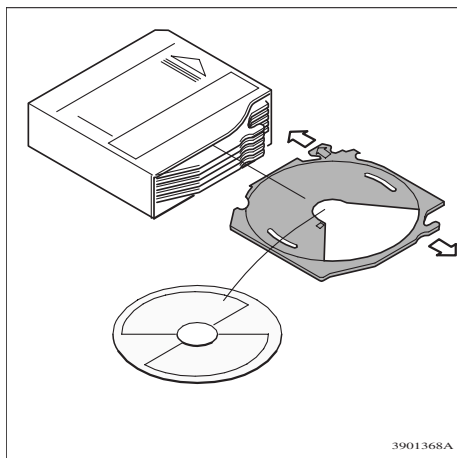

### CD 6 changer

The CD 6 changer, which is available separately, is loaded with a cartridge which can accommodate 6 discs. If no CD 6 changer is connected, pressing the **CD 6** button will have no effect.

To operate:

- Slide the lid on the CD changer forward and press the eject button to remove the cartridge.
- Pull out the tray and place the disc on it, label up. Insert the tray into the cartridge.
- Insert the cartridge in the CD changer in the direction indicated by the arrow on the top

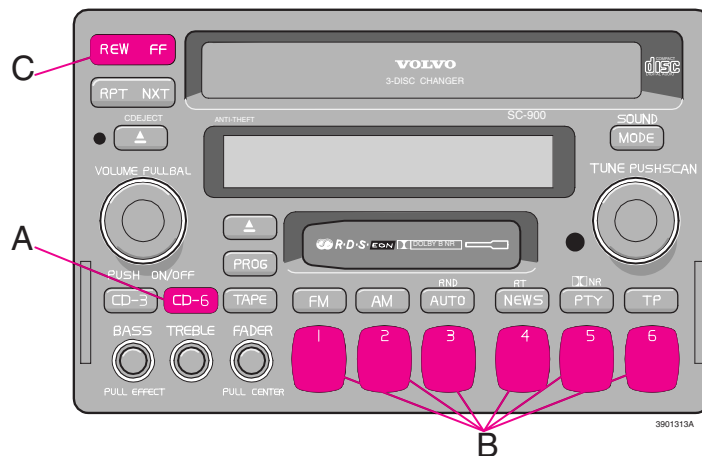

- side of the cartridge, and close the cover.
- Remove the discs from the cartridge by pulling out the trays.

### A - CD 6 changer - on

Press the '**CD 6**' button to activate the CD 6 mode. The CD 6 changer will start playing the last disc and track to be played. If the CD 6 changer cartridge is empty, 'No Disc' will appear in the display. If a selected disc does not exist, the disc number and 'CD X-00' (X is the disc number) will appear in the display, and the next disc will automatically be selected. If there is no cartridge in the CD 6 changer, 'No Magazine' will appear in the display.

### B - Disc number selector

Press one of the preselect buttons (1-6) to select the disc number required.

The selected disc number and track number will be displayed.

### C - Music search

Press the '**FF**' or '**REW**' buttons to search within a track. While the button is pressed, the playing time for this track is displayed.

## CD 6 Changer (retailer option)



3901314A

### A - Changing the selected track number

Press 'NXT' to move forward to the next track, 'RPT' to repeat the previous track or turn the manual tuning knob. The selected disc number and track number will be displayed.

### B - Playing-time display

When the 'FF' or 'REW' buttons are pressed, the playing time for the current track is displayed for 5 seconds.

## CD 6 Changer (retailer option)

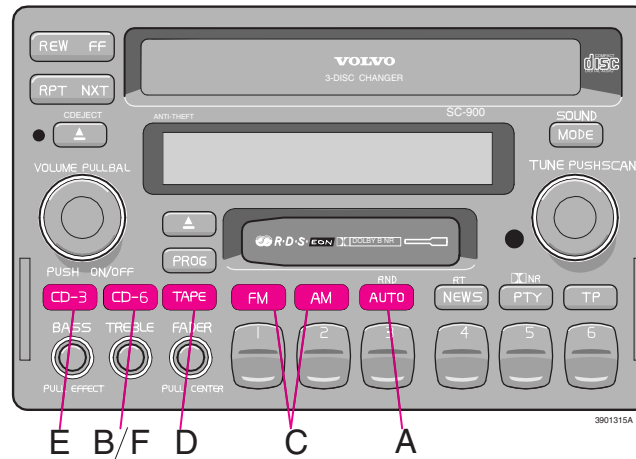

### A - Random choice

Press 'RND' to activate the random function. Randomly selected tracks will play from randomly selected discs. 'RND' (random) appears in the display while the function is on.

### B - Pause

If you press the CD 6 button, the sound is switched off and 'Pause' appears in the display. Press the CD 6 button again to restart the CD 6 changer.

### C - To return to the radio mode

Press the FM or the AM button.

### D - To return to the tape mode

If a cassette is already inserted, you can return to tape mode by pressing the 'TAPE' button.

### E - To return to the CD 3 mode

If the CD 3 player has been switched off but the cartridge has not been ejected, you can return to the CD 3 mode by pressing the CD 3 button.

### F - To return to the CD 6 changer mode

If the CD 6 changer has been switched off, you can return to the CD 6 changer mode by pressing the CD 6 button.

## Dolby Pro Logic Surround Sound (certain models)

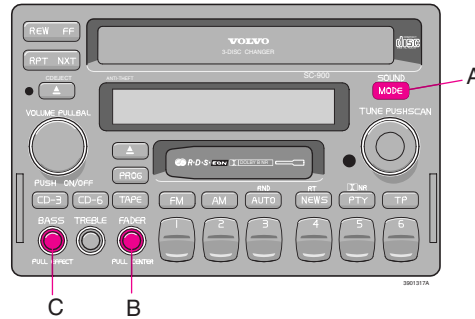
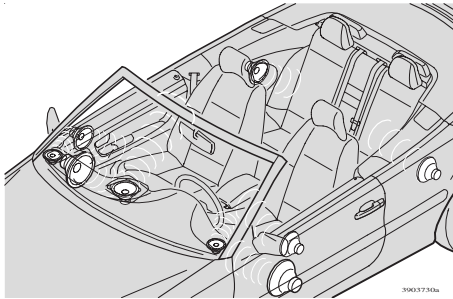

### Dolby Pro Logic Surround Sound

Together with a center speaker mounted at the center of the dash, Dolby Pro Logic Surround Sound offers much clearer and more realistic sound.

Through a connection to a special decoder (optional on certain models), as well as a center speaker (option), the normal left-right stereo channels are divided into left-center-right. In addition, "surround" sound can be created from the car's rear speakers.

Most modern discs are recorded so that vocals are heard in the center foreground, while the orchestra is heard across the entire left-right range, as well as from behind.

### A - Engaging Surround Sound

Press the 'MODE' button to engage the center speaker and the surround unit. The mode selected will be displayed.

"3 CH" = center speaker also engaged.

"Dolby Pro Logic" = Dolby Pro Logic engaged with surround effect from rear speakers \*.

### B - Center speaker volume control

First press the button in slightly to pop it out, then pull the button out completely and turn it to adjust the volume of the center speaker.

### C - Surround effect volume control

First press the button in slightly to pop it out, then pull the button out completely and turn it to adjust the volume level from the rear speakers (Dolby Pro Logic only).

\* SC-900 - will not function in AM or FM Radio mode.

SC-901 - will not function in AM Radio mode.

## Other settings

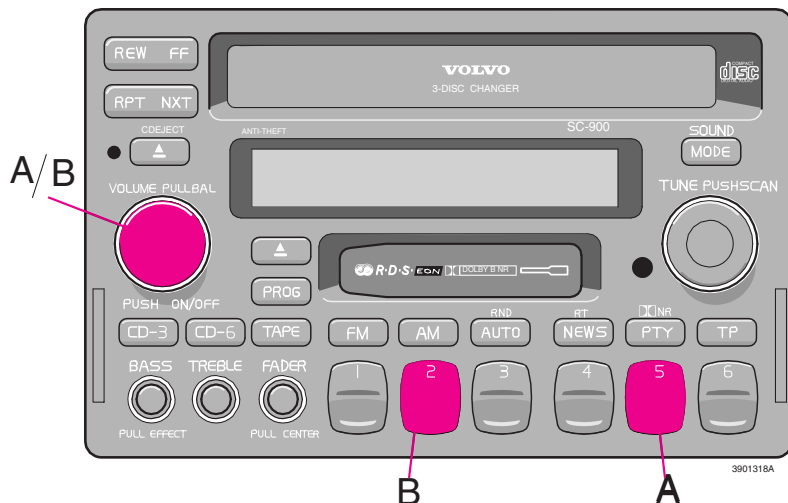

### A - Settings for individual markets

Settings for individual markets are usually adjusted in the factory or at the retailer. If you need to change this setting: switch off the radio; hold down preset button 5 (A); switch on the radio (A) and press preset button 5 again until the relevant market (US, AUS or EU) appears.

### B - Setting the internal equalizer

To select the frequency correction:

- Switch off the radio.
- Hold down preset button 2 (B).
- Switch the radio on again.
- Press button 2 until the desired curve appears : S70-V70-S40-V40-Custom.

### Setting the custom equalizer (Custom EQ) - SC-901 only

- Select "Custom EQ" by switching off the radio, holding down preset button 2 and switching the radio again. Select "Custom" (see point B).
- Press Scan.

- Press preset button 1-5 within 5 seconds:
  - Preset button 1 = set bass (60 Hz)
  - Preset button 2 = set mid-range bass (200 Hz)
  - Preset button 3 = set lower mid-range (800 Hz)
  - Preset button 4 = set upper mid-range (3 kHz)
  - Preset button 5 = set treble (12 kHz)
- Adjust the setting by turning the Tune knob clockwise (increase) or counterclockwise (decrease). The change can be seen in the display, as well as heard.
- Use preset button 6 to adjust the settings of the front or rear speaker.
  - F = Front
  - R = RearPlease note that the equalizer curves can be adjusted separately for the front and rear speakers.
- When you are satisfied with the adjustments you have made, press Scan again to store the settings.
- Press Scan once again to exit the settings mode.
- To select "Custom EQ", press the Volume knob.



## Technical specifications

### SC-901

Output (center speaker):	1 x 25 W
Output (supplementary amplifier):	4 x 100 W, 10% dist
Frequency range:	30 - 20,000 Hz
S/N:	min.74 dB rel. to 1 W
Output impedance:	4 Ohms
System voltage:	12 V, negative ground

### Radio

Volvo's SC-901 stereo system contains a microprocessor-controlled radio receiver with PLL (Phase Lock Loop), designed for RBDS (Radio Broadcast Data System). The SC-901 must be connected to a separate power amplifier.

#### Frequency range:

AM	530 - 1710 kHz
FM	87.7 - 107.9 MHz

#### Sensitivity:

AM	2.2 $\mu$ V
FM	1.1 $\mu$ V

**Stereo separation:** 35 dB

### Cassette deck

4-track, 2-channel stereo  
Full logic electronic tape transport

Tape speed:	4.76 cm/sec.
Channel separation:	40 dB
Frequency range:	30 - 15,000 Hz
S/N (120 $\mu$ V):	50 dB
Wow and Flutter:	< 0.07%
Pinch-off	

#### Alert

'Alert!' will be displayed in the radio's display when emergency information is broadcast. This function is used to warn drivers in the event of a serious accident or disaster situation.

Dolby noise reduction is manufactured under license from Dolby Laboratories Licensing Corporation.

"Dolby", "Pro Logic" and the double-D symbol are trademarks of Dolby Laboratories Licensing Corporation. The Dolby Pro Logic Surround System is manufactured under licence from Dolby Laboratories Licensing Corporation.

**CAUTION:** The supplementary amplifier may be mounted under the front passenger's seat. If the floor of the car has become soaked for any reason, do not turn on the radio. This would cause damage to the amplifier. Contact a Volvo retailer.

## Audio systems, general information

### Cassettes

- Store cassettes in their cases.
- Do not touch the tape surface with your fingers.
- Tapes should not be exposed to direct sunlight or extreme temperatures.
- Keep tapes away from oil, grease and other contaminants.
- For optimal tape deck performance Volvo does not recommend the use of C-120 tapes.
- Take up slack using a pen or a pencil before inserting a cassette in the cassette slot.

### Cassette cleaning

We recommend the use of the Volvo Cleaning Cassette available as a genuine Volvo accessory. Regular use improves sound quality, cleans vital parts and prevents tape tangle.

### Compact disc care

- Before using a new disc for the first time, remove any burrs in the center/outer edge by running the stem of a pen or similar object around the hole/edge of the disc.
- Use high quality discs only.
- Keep the discs clean. Wipe them with a soft, clean, lint-free cloth, working from the center outwards. If necessary, dampen the cloth with a neutral soap solution. Dry thoroughly before using.
- Never use cleaning spray or antistatic liquid. Use only cleaners specifically made for CD's.
- Use discs of the correct size only (3.5" discs should never be used).
- Do not put tape or labels on the disc itself.
- Volvo does not recommend the use of plastic outer rings on the disc.
- Condensation may occur on discs/optical components of the changer in cold winter weather. The disc can be dried with a clean, lint-free cloth. Optical components in the CD changer may, however, take up to one hour to dry off.
- Never attempt to play a disc which is damaged in any way.
- When not in use, the discs should be stored in their covers. Avoid storing discs in excessive heat, direct sunlight or dusty locations.

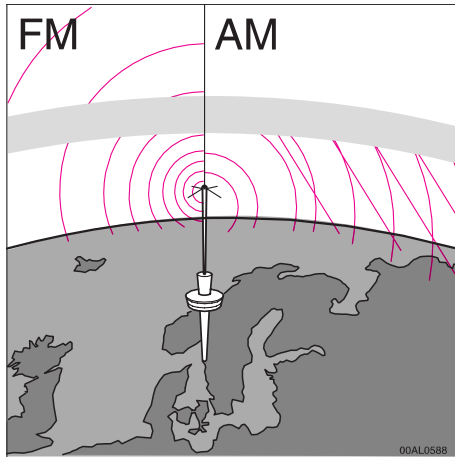

### Sending signals

The FM waves do not follow the earth's surface nor do they bounce off the atmosphere. For this reason their range is limited. The AM waves follow the earth's surface and reflect against the atmosphere, giving them a wide range.

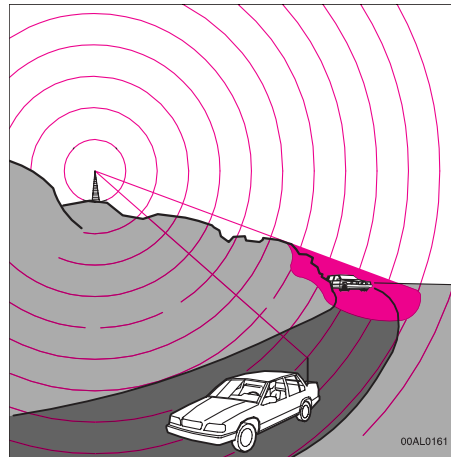

### Weak reception (fading)

Because of the limited range of the FM senders and the fact that these waves are very reflective, this problem usually occurs with FM reception. If the sender is blocked by buildings or mountains, static can result.

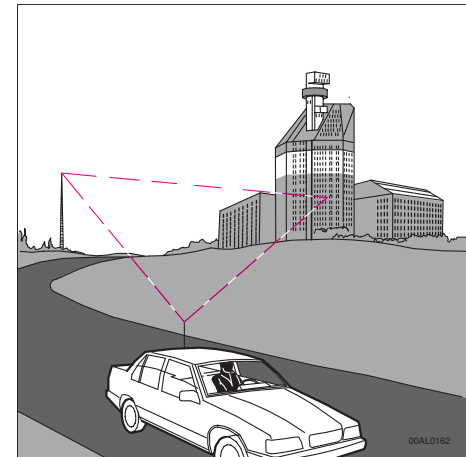

### Static

The reason why FM but not AM is audible in covered parking areas, under bridges, etc., is that FM signals reflect against solid objects such as buildings. Because these waves are very reflective, static can result. This static is the result of the reflected signal and the direct signal reaching your antenna at slightly different times causing a cancellation of all signals. This problem occurs largely in built-up areas. Your car is equipped with a dual antenna system which helps alleviate this problem.

## Audio systems, general information

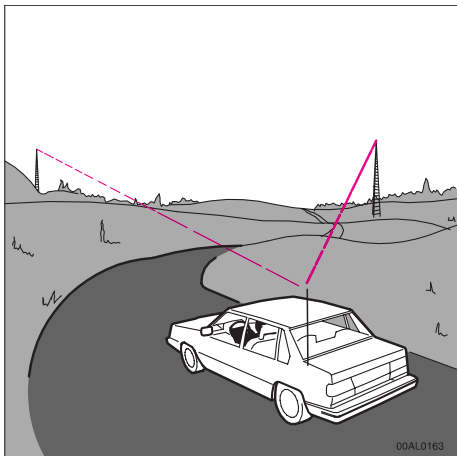

### Cross modulation

If you listen to a weak station in the vicinity of a stronger one, both stations may be received simultaneously. If the car is moved a short distance, the weaker signal may be heard more clearly.

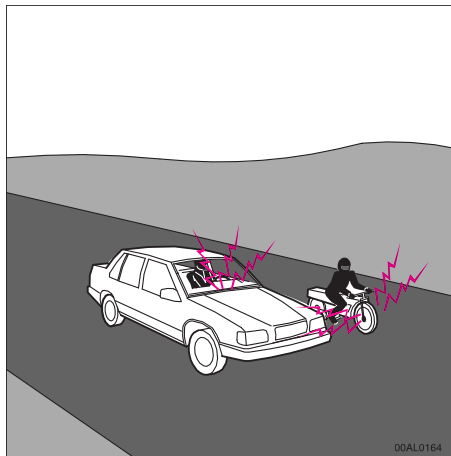

### FM - reasons for distortion

FM is affected by the electrical systems of nearby vehicles, especially those without suppression. The distortion increases if the station is weak or poorly set.

The FM reception is not as sensitive to electrical disturbance as AM.

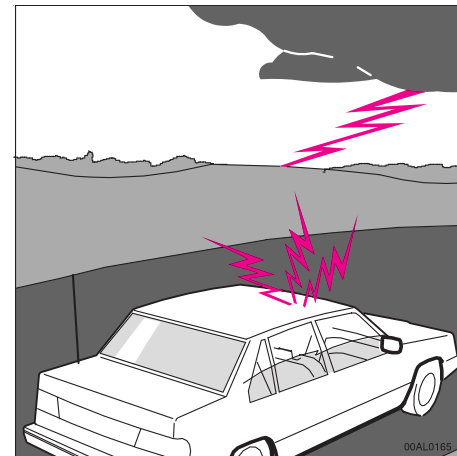

### AM - reasons for distortion

AM reception is sensitive to electrical disturbances such as power lines, lightning, etc.

---

---

## Audio systems, general information

### FM stereo reception

Stereo reception places very high demands on the signal quality which means the type of distortions previously mentioned become even more obvious. The signal strength needs to be stronger for good stereo reception and this limits the effective range of the sender.

We hope that this information proves to be useful and provides you with a better understanding of the problems related to car radio reception.

Reception conditions are not always optimum and this is, of course, beyond our control.

However, we have endeavored to make the Volvo Audio System of a quality that will enable you to enjoy the best possible reception no matter what the reception conditions may be.

### Radio antennas

**NOTE:** Always lower the antenna when using an automatic car wash or entering a garage.

The antenna should be cleaned at least every 15,000 miles (24,000 km) or more frequently if needed. Use WD40 for cleaning.

Spray the antenna with WD40 and wipe it clean and dry with a rag. Spray it again. Lower and raise the antenna. Wipe it clean and dry again. Lower and raise the antenna 4-6 times.

Make sure it is dry and free from dirt or lubricating oil.

### Diversity antenna (dual antenna system)

Certain models are equipped with the optional Diversity dual antenna system. Two antennas are connected to the radio through two separate sockets, allowing for better reception and reducing the effects of static or multipath distortion of FM reception.



**A**

ABS ..... 17  
 Air conditioning ..... 35  
 Air filter - engine ..... 119  
 Air mix ..... 33  
 Air vents ..... 33  
 Airbag (SIPS) ..... 8  
 Airbag (SRS) ..... 4  
 Alarm ..... 45  
 Ambient temperature sensor ..... 25  
 Anti-lock Brake System (ABS) ..... 17,74  
 Antifreeze ..... 77  
 Ashtrays ..... 31  
 Audio systems  
     General information ..... 192  
     SC-813 ..... 140  
     SC-816 ..... 153  
     SC-900/901 ..... 169  
 Automatic car washing ..... 113  
 Automatic daytime running lights ..... 24  
 Automatic transmission ..... 66,135  
     Kickdown ..... 67  
 Automatic transmission fluid ..... 132

**B**

Battery ..... 77,136  
 Battery drain - avoiding ..... 57  
 Battery maintenance ..... 128  
 Brake failure warning light ..... 17,18  
 Brake fluid ..... 124,132  
 Brake fluid warning light ..... 18  
 Brake system ..... 74,75  
 Brake warning light ..... 17

Bulb failure warning ..... 17,19  
 Bulbs, list of ..... 136  
 Bulbs, replacing ..... 94

**C**

Capacities ..... 135  
 Catalytic converter ..... 129  
 Central locking system ..... 44  
 Changing a wheel ..... 90  
 Changing bulbs ..... 94  
 Child safety ..... 12  
 Child seat anchors, ISOFIX ..... 11  
 Cleaning the convertible top ..... 113  
 Climate control system ..... 34  
 Clock ..... 16  
 Clock - resetting ..... 25  
 Clutch fluid ..... 124  
 Clutch interlock ..... 65  
 Convertible top - cleaning ..... 113  
 Convertible top - electrically operated ..... 40  
 Convertible top - manually raising ..... 107  
 Coolant - checking/changing ..... 126  
 Coolant level sensor ..... 19  
 Coolant level warning light ..... 17  
 Cooling system ..... 69,134  
 Courtesy lights - exterior ..... 20  
 Courtesy lights - front ..... 51  
 Cruise control ..... 29

**D**

Daytime running lights ..... 24  
 Demister - rear window ..... 23  
 Dimensions ..... 137

Distributor ignition system ..... 134  
 Diversity antenna ..... 195  
 Doors and locks ..... 43  
 Driving economy ..... 63  
 Driving mode W ..... 67,77

**E**

EBD - Electronic Brake-force Distribution . 75  
 ECC - Electronic Climate Control ..... 34,35  
 Electrical system ..... 69,136  
 Electrically heated front seats ..... 30  
 Electrically operated convertible top ..... 40  
 Electrically operated front seats ..... 47  
 Electrically operated windows ..... 36  
 Electronic Brake-force Distribution (EBD) 75  
 Emergency towing ..... 71,72  
 Emergency warning flashers ..... 23  
 Engine ..... 133  
 Engine air filter ..... 119  
 Engine compartment ..... 127  
 Engine oil ..... 122-123,132  
 Engine oil - checking/changing ..... 122  
 Engine oil pressure ..... 17  
 Exterior courtesy lights ..... 20

**F**

Fog light - rear ..... 17,22  
 Fog lights - front ..... 22  
 Front courtesy lights ..... 51  
 Front fog lights ..... 22  
 Front seats ..... 47  
 Front seats - heated ..... 30  
 Front seats - memory function ..... 47

## Index

Fuel filter ..... 119  
Fuel gauge ..... 16  
Fuel level ..... 17  
Fuel requirements ..... 60,61  
Fuel system ..... 119,134  
Fuel tank cover - opening ..... 37,62  
    opening manually ..... 106,107  
Fuses ..... 100-102  
Fuses - replacing ..... 100

## G

Gas tank cover - opening ..... 37,62  
    opening manually ..... 106,107  
Generator ..... 17,136  
Glossary of tire terminology ..... 85

## H

Hand brake ..... 30  
Handling ..... 68  
Hazard warning flashers ..... 23  
Headlight wiper blades - replacing ..... 105  
Headlights ..... 20  
Heated front seats ..... 30  
Heated side-view mirrors ..... 23  
Heating and air conditioning ..... 33  
High beams ..... 17  
Hoisting the car ..... 118  
Hood ..... 54

## I

Ignition switch ..... 21  
Immobilizer (start inhibitor) ..... 43

Instrument illumination ..... 22  
Instruments ..... 14,15  
ISOFIX/LATCH anchors ..... 11

## J

Jack ..... 56,90  
Jump starting ..... 73

## K

Keyless entry system ..... 44  
Keylock ..... 64  
Keys ..... 43  
Kickdown ..... 67

## L

Label information ..... 116  
LATCH/ISOFIX anchors ..... 11  
Lifting the car ..... 118  
Locks ..... 43  
Long load storage ..... 53  
Lubrication ..... 121  
Luggage racks - trunk-mounted ..... 70  
Lumbar support ..... 49

## M

Maintenance service ..... 117  
Malfunction indicator lamp ..... 17  
Manual transmission ..... 65,135  
Manually raising convertible top ..... 107  
Memory function - front seats ..... 47  
Mirrors - rear/side view ..... 50

## O

Occupant safety ..... 13  
Octane rating ..... 62  
Odometer ..... 16  
Oil (engine) ..... 122-123,132  
Oil pressure warning light ..... 18  
Opening the trunk from the inside ..... 55

## P

Paint touch-up ..... 110  
Parking brake ..... 17,30  
Parking brake reminder light ..... 18  
Parking lights ..... 20  
PCV system ..... 119  
Polishing ..... 113  
Power seats ..... 47  
Power steering fluid ..... 124,132  
Proposition 65 warning ..... 128

## R

Radio  
    General information ..... 192  
    SC-813 ..... 140  
    SC-816 ..... 153  
    SC-900/901 ..... 169  
Radio Broadcast Data System - RBDS ..... 174  
Rear fog light ..... 17,22  
Rear suspension ..... 134  
Rear window demister ..... 23  
Rear/side-view mirrors ..... 50  
Refueling ..... 62  
Remote control (central locking system) ..... 44



Remote keyless entry system .....	44	Steering wheel adjustment .....	32	Warranty .....	117
Replacing bulbs .....	94-99	Steering wheel lock .....	21	Washer fluid level .....	17
Replacing fuses .....	100	Storage compartments .....	42	Washer fluid reservoir .....	125
Reporting safety defects .....	13	<b>T</b>		Washing .....	112
Road assistance .....	138	Tachometer .....	16	Waxing .....	113
Roadholding .....	68	Temperature gauge .....	16	Wheels and tires .....	80
Roll Over Protection System (ROPS) .....	10	Three-way catalytic converter .....	129	Whiplash Protection System (WHIPS) .....	9
<b>S</b>		Timing belt .....	119	Wind deflector .....	41
Safety defects - reporting .....	13	Tires - changing .....	90	Windshield washer nozzles .....	125
Seat belt maintenance .....	13	Towing .....	71,72	Windshield washers/wipers .....	21
Seat belts .....	2,3,11	Towing the car .....	72	Windshield wiper blades - replacing .....	104
Automatic Locking Retractor .....	11	Trailer towing .....	76	Winter driving .....	77
Emergency Locking Retractor .....	11	Trip computer .....	23,26-28	Winter/Wet driving mode .....	67, 77
Seat belts - cleaning .....	114	Trip odometer .....	16		
Seats .....	47	Trunk - opening from the inside .....	55		
Seats - heated .....	30	Trunk - opening/locking .....	55		
Securing cargo .....	57	Trunk light .....	56		
Service reminder indicator .....	17	Turn signals .....	17,20		
Servicing .....	118,120	<b>U</b>			
Shiftlock .....	64, 66	Upholstery care .....	114		
Shiftlock release (override) .....	106	<b>V</b>			
Side Impact Protection System (SIPS) .....	8	Vanity mirrors .....	52		
Side-view mirrors - heated .....	23	Vehicle Identification Number (VIN) .....	116		
SIPS .....	8	Vehicle loading .....	135		
Spare tire .....	56	Volvo On Call .....	138		
Spark plugs .....	119,134	<b>W</b>			
Specifications .....	131	Warning flashers .....	23		
SRS .....	5-7	Warning lights .....	18,19		
SRS diagnostic system .....	19				
SRS warning light .....	5,17,19				
Stability and Traction Control (STC) .....	19,23,75				
Start inhibitor (immobilizer) .....	43				
Starting the engine .....	64				



**Notes**

.....

.....

.....

.....

.....

.....

.....

.....

.....

.....

.....

.....

.....

.....

.....

.....

**Notes**

.....

.....

.....

.....

.....

.....

.....

.....

.....

.....

.....

.....

.....

.....

.....

.....

.....

.....

.....

.....

.....

.....



